

N. M. POLONEITCHIK, K. I. CHISTIK

IMPRESSION MATERIALS



Minsk BSMU 2018

Розвиток БГМУ

ISBN 978-985-21-0089-2



9 789852 100892

МИНИСТЕРСТВО ЗДРАВООХРАНЕНИЯ РЕСПУБЛИКИ БЕЛАРУСЬ
БЕЛОРУССКИЙ ГОСУДАРСТВЕННЫЙ МЕДИЦИНСКИЙ УНИВЕРСИТЕТ
КАФЕДРА ОБЩЕЙ СТОМАТОЛОГИИ

Н. М. Полонейчик, К. И. Чистик

ОТТИСКНЫЕ МАТЕРИАЛЫ

IMPRESSION MATERIALS

Учебно-методическое пособие

2-е издание



Минск БГМУ 2018

УДК 616.314-74:615.46(075.8)-054.6

ББК 56.6я73

П52

Рекомендовано Научно-методическим советом университета в качестве
учебно-методического пособия 21.02.2018 г., протокол № 6

Рецензенты: д-р мед. наук, проф. С. А. Наумович; д-р мед. наук, проф.
И. В. Токаревич; канд. филол. наук, доц. М. Н. Петрова

Полонейчик, Н. М.

П52 Оттисковые материалы = Impression materials : учебно-методическое пособие /
Н. М. Полонейчик, К. И. Чистик. – 2-е изд. – Минск : БГМУ, 2018. – 39 с.

ISBN 978-985-21-0089-2.

Содержит необходимые студенту сведения об оттисковых материалах, их классификации
и свойствах. Рассматривается каждая группа оттисковых материалов, их достоинства, недостатки
и показания к применению. Первое издание вышло в 2017 году.

Предназначено для иностранных студентов 1-го курса, обучающихся на английском языке.

УДК 616.314-74:615.46(075.8)-054.6

ББК 56.6я73

ISBN 978-985-21-0089-2

© Полонейчик Н. М., Чистик К. И., 2018

© УО «Белорусский государственный
медицинский университет», 2018

INTRODUCTION

The main aim of this textbook is to present impression materials.

Impression materials is a group of auxiliary dental materials that is used in prosthodontics in the dentist's everyday practice.

Receiving a qualitative impression is one of the main goals which the doctor faces at the prosthodontics treatment of patients with various diseases of a dento-alveolar system. The impression is the only and main information carrier of a clinical situation in the oral cavity of the patient transferred to the dental laboratory. Success of the dentures production directly depends on an accuracy and a constancy of the sizes of prosthetic tissues replica.

Superfine impression materials are necessary for the high-quality production of dentures. In recent years their range considerably extended. Nowadays there are impression materials of various chemical composition and properties. A big variety of materials, a special technic of preparation of each of them, various properties and indications to use, considerably complicate the medical choice.

Each of impression materials has advantages and disadvantages. For a right choice of the impression material depending on a clinical situation the doctor needs to know characteristics and properties of impression materials.

This textbook includes information on properties and composition of impression materials, knowledge about it individualizes indications to their use, causes technology of preparation, use, storage conditions and other practical decisions referred on quality of the prosthodontics treatment of dental diseases improvement.

IMPRESSION MATERIALS. GENERAL CHARACTERISTIC AND CLASSIFICATION

Prosthetic bed — tissues with which the denture is in direct contact (E. I. Gavrilov) (fig. 1, *a*).

Cast — positive replica of the oral cavity or any other object.

Model — a study purpose cast which has a positive reproduction of prosthetic bed tissue relief in real sizes received after taking impressions with the use of auxiliary (model) materials (fig. 1, *d*, *e*).

Dental impression — a negative replica of the tissues of the mouth (fig. 1, *b*, *c*).

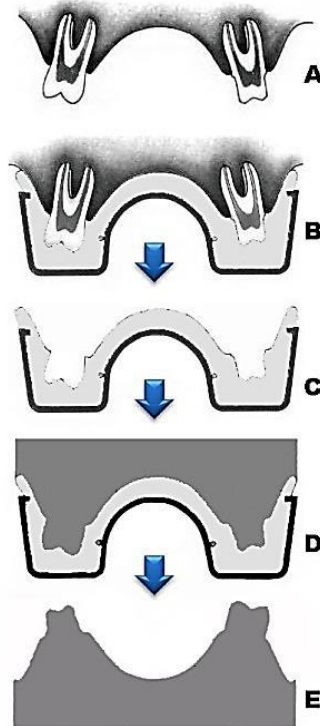

Fig. 1. Sequence of a non-folding plaster model manufacturing on a negative replica of the prosthetic bed tissue relief:

a — prosthetic bed; *b* — impression taking; *c* — ready impression in the impression tray; *d* — putting a model mass into the ready impression; *e* — ready model

So, impression materials are used to register or reproduce the form and relationship of teeth and oral tissues. From this replica, or impression, a model can be made which is used in the construction of complete dentures and partial removable dentures, crowns, bridges and inlays.

Over the years, a wide variety of impression materials and associated techniques have been developed in order to achieve the optimum in desirable characteristics.

Desirable properties of an impression can be summarized briefly as follows:

- pleasant odor, taste, and esthetic color;
- absence of toxic or irritant constituents;

- adequate shelf life of storage and distribution;
- economically commensurate with the obtained results;
- easy to use with the minimum of equipment;
- setting characteristics that meet clinical requirements:
 - satisfactory consistency and texture;
 - readily wets oral tissues;
 - elastic properties with freedom from permanent deformation after strain;
 - adequate strength so it will not break or tear during removal from the mouth;
 - dimensional stability over temperature and humidity changes which can be normally found in clinical and laboratory procedures for a period long enough to permit the production of a cast or die;
 - compatibility with cast and die materials;
 - accuracy in clinical use;
 - readily disinfected without loss of accuracy;
 - no release of gas during the setting of the impression or cast and die.

There are several classifications of impression materials. According to *Philips science of dental materials* impression materials are classified on the basis of setting and elasticity (table 1).

Table 1

Classification of impression materials based on their setting reaction and elasticity

Mode of setting	Rigid	Elastic
Set by chemical reaction (irreversible)	Impression plaster Zinc oxide-eugenol	Alginate hydrocolloid <i>Nonaqueous elastomers:</i> Posulfide Polyether Condensation silicone Addition (vinyl) silicone
Set by temperature change (reversible)	Compound	Agar hydrocolloid

Hydrocolloids and synthetic elastomeric polymers are among the materials most commonly used to make impressions of various areas of the dental arch, whereas zinc oxide-eugenol and modeling compound are used less frequently. Each of these classes of materials has certain advantages and disadvantages. An understanding of the physical characteristics and the limitations of each material is necessary for their successful use in clinical dentistry.

The choice of impression material may also be affected by the technique to be adopted, with a major consideration being the selection of a stock tray or special tray. These trays are needed to support the impression material (especially when it is still fluid), so that it can be carried to the patient, inserted in the mouth, and removed once it is set. The trays also provide support when the model is poured from the impression.

The choice of impression tray is to some extent determined by the viscosity of the impression material. An impression material that is very fluid when it is first

mixed cannot be used with a stock tray and a close fitting special tray needs to be produced. This can be done either by constructing an acrylic special tray from a preliminary model, or by using a high viscosity material, which is placed in a stock tray and, once this has set, a special tray is produced. Some impression materials are not available with a sufficiently high viscosity version for use in a stock tray, and these include zinc oxide-eugenol, polyether and polysulphide elastomers. Others, such as impression compound (compo), plaster of Paris, alginate and the silicones are available in formulations that can be used with a stock tray. Although compo can be used in a stock tray, the impression obtained does not reproduce surface details adequately unless a zinc oxide-eugenol wash is used with it. Similarly, alginates, when used in a stock tray, do not always give the required degree of accuracy and are then better used in a special tray.

PROPERTIES OF IMPRESSION MATERIALS

THE IMPRESSION MATERIAL LINEAR SIZES CHANGES

An impression material has to replicate the relief of the prosthetic bed in detail and make it possible to obtain easily separated plaster model having a smooth surface.

To check these properties tests using the block made of stainless steel with three parallel grooves A, B and C — 50, 20 and 75 μm width are carried out (fig. 2, 3). Two parallel grooves (lines D) which are at distance of 25 mm from each other are used for the impression's linear size changes assessment.



Fig. 2. A test block and a ring form for the assessment of the impression material reproduction of the surface relief, its compatibility with plaster and linear size changes

The operating mode of these tests includes preparation of the impression material, filling of the ring form with it and imposition of the test block on the material. The material hardens at the temperature of 35 °C.

After the impression material curing (hardening) the ring form is separated from the test block and by means of a lens the accuracy of grooves display by the impression material is rated. For the assessment of the impression material and the plaster model compatibility, the surface of the impression is washed out as directed by the manufacturer, rated, a cutting form is placed on it and filled with the plaster for models (type 3 or 4 by ISO 6873). After the plaster hardening the model is separated from the ring form containing the impression material and

the model is inspected. In making an assessment of the model the attention should be paid to the grooves that are completely reproduced on all length (25 mm) and whether the remains of impression material are on the casting surface and how smooth it is.

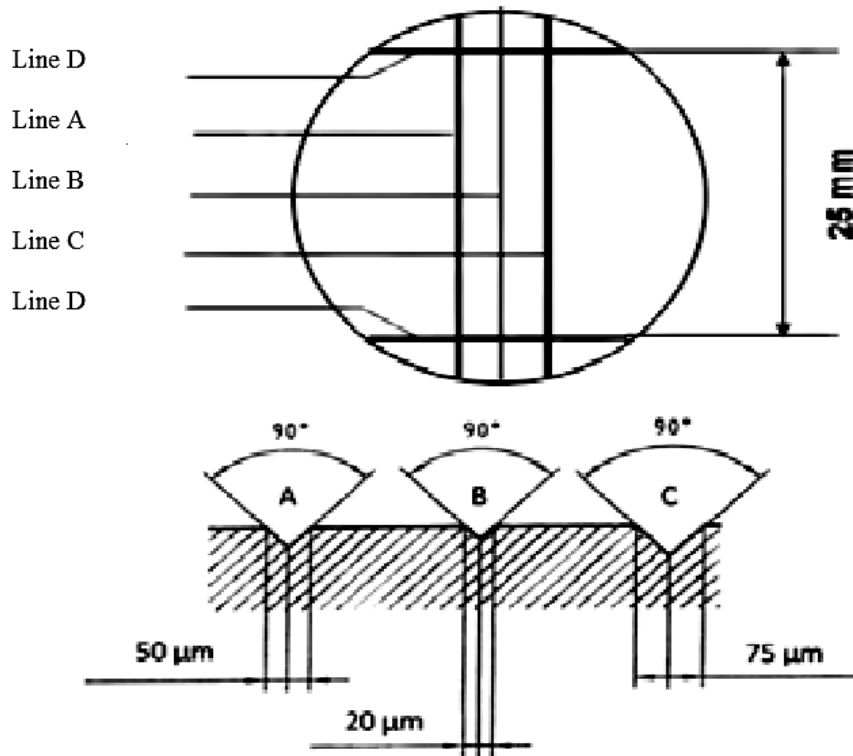

Fig. 3. The scheme of the test block for the assessment of the surface relief reproduction by the impression material, its compatibility with the plaster and the linear sizes changes

Along with the accuracy of the prosthetic tissues display, stability of the impression material initial sizes in the process of its storage is very important. Dimensional stability depends on the shrinkage of the impression material (property of materials to decrease in linear sizes and in volume when hardening, cooling, storage). For the assessment of the linear sizes change (the impression materials shrinkage) the equipment given in fig. 3 is used. The impression material sample is received according to the description given above. After binding time (crystallization, jellification, polymerization) the ring form with the impression material is separated from the test block and the distance between lines D-D (nominally 25 mm) designated as L_1 is measured by means of the comparator. The samples are stored at the temperature of 23 ± 2 °C and relative humidity 50 ± 10 %. During the process of the samples storage distances between the D-D lines (L_2) are measured repeatedly at different periods of time lasting not less than 24 hours. The calculation of the linear sizes change in percentage (ΔL) is carried out on the formula:

$$\Delta L = 100 \times \left(\frac{L_1 - L_2}{L_1} \right).$$

THE IMPRESSION MATERIAL VISCOSITY

One of the impression material properties which is surely estimated by dentists, is the material ability to spread on the surface of prosthetic tissues with the penetration into hard-to-reach areas in the regions of a dentogingival groove. This property of materials depends on their viscosity.

Viscosity of polymers solutions is characterized by resistance to the liquid movement caused by the coefficient of internal friction. Viscosity depends on a length of a macromolecule, a degree of its elongation, a force of the intermolecular interaction, a solution concentration, a pressure under which the solution expiration takes place. In the quantitative expression indicators of the impression material viscosity are inversely proportional to indicators of its fluidity (the property of materials to be deformed under the mechanical tension influence). The viscosity of the material is determined by the percentage of filler and the length of the polymer chain. The viscosity of the material can be measured by a special device (fig. 4).

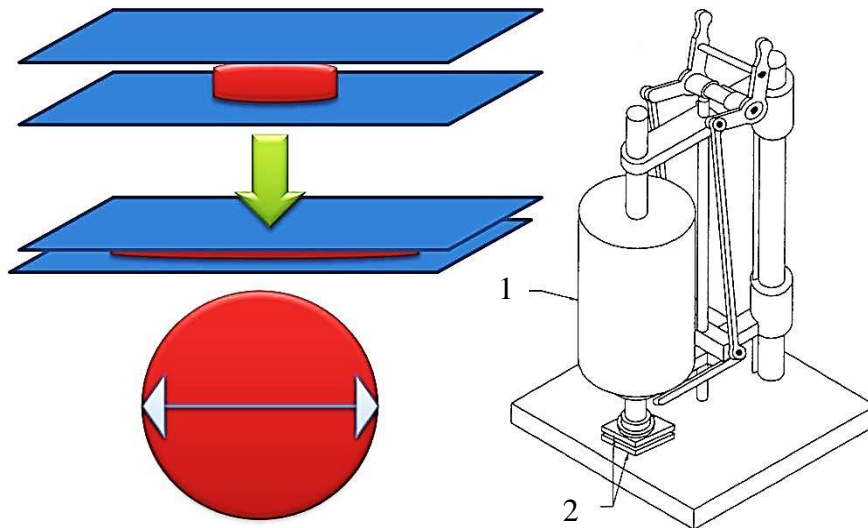

Fig. 4. The technique and device for the assessment of the impression material viscosity:
1 — load weighing 1500 g; 2 — glass plates

THE IMPRESSION MATERIAL HARDNESS

One of the impression material mechanical properties indicators is hardness — ability of the material to resist penetration of a more solid body into it at a certain load. In the dental material science various ways of hardness determination based on immersion into the materials of an indenter (tip) in the form of a ball (Brinell's method), a diamond pyramid (Vickers's, Knupp's methods), a cone (Shor's D method) or the truncated cone (Shor's A method) are applied.

For elastomer hardness determination Shor's A method is used. The depth of indenter indentation into the material under the influence of the force under the given conditions is measured. Shor's A hardness is inversely proportional to the depth of indentation and depends on the viscoelastic properties of the material.

THE IMPRESSION MATERIAL DEFORMATION IN COMPRESSION

In the practical work of the doctor there is no universal impression material which could be applied in all clinical situations. Therefore the doctor has to have rather big range of impression materials in order to choose the most acceptable in accordance with a specific objective. One of the impression material choice criteria is the characteristic of its deformation in compression.

The equipment having the dial indicator graduated in 0.01 mm and measuring effort $0.6H \pm 0.1H$ is used to determine compression deformation.

The test sample 20 mm in height and 12.5 mm in diameter (fig. 5) is prepared by means of special forms. On completion of material hardening time of the sample is subjected to a low load of $125 \text{ g} \pm 10 \text{ g}$, carrying it out in the following way: pressure in 0.01 N/mm^2 for elimination of possible gaps in the measuring system. The indications of the dial indicator (h_1) are read out. Then the load is increased till $1250 \pm 10 \text{ g}$, making, thus, the general pressure in 0.1 N/mm^2 , and the indications (h_2) are repeatedly read out. The compression deformation (E) is counted in percentage terms, on the formula:

$$E = 100 \left(\frac{h_1 - h_2}{h_0} \right),$$

where h_0 is the initial height of the sample in millimeters.

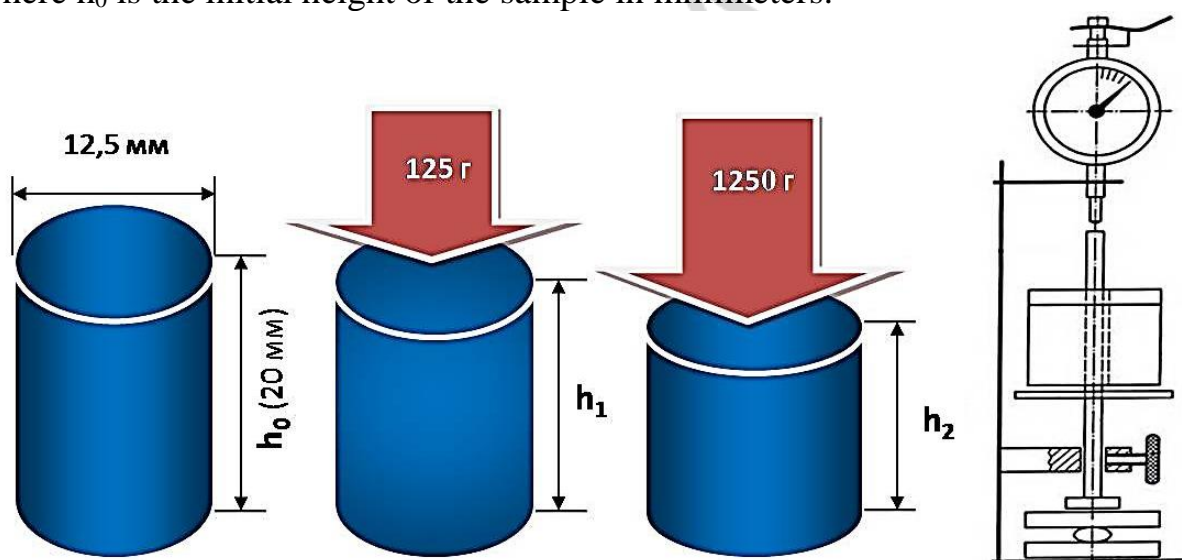

Fig. 5. Schemes of the assessment of the impression material deformation in compression and devices for sample load

THE IMPRESSION MATERIAL RESTORATION AFTER DEFORMATION

In the process of receiving the impression fluid impression materials get into interdental intervals and other hard-to-reach areas (fig. 6, a). During the removal of the impression after material hardening it is subjected to deformation (fig. 6, b). Accuracy of the prosthetic tissues negative display in many aspects depends on how full the impression material initial size restoration out of the oral cavity (fig. 6, c) will be.

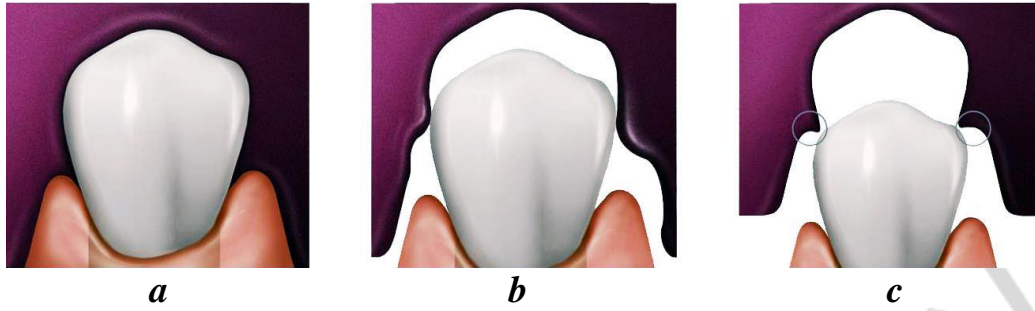

Fig. 6. The scheme of the impression material restoration after the deformation

The characteristic of the material restoration after the deformation can be given only to the group of elastic materials as rigid impression materials don't have elastic properties and aren't exposed to elastic deformations.

Tests are carried out on samples 20 ± 0.2 mm in height and 12.5 ± 0.05 mm in diameter made by means of special forms.

The program of tests provides deformation of the sample within 5 seconds in height up to 14 ± 0.1 mm (fig. 7), removal of the load with preservation of the probe contact with the sample and reading H index by the dial indicator.

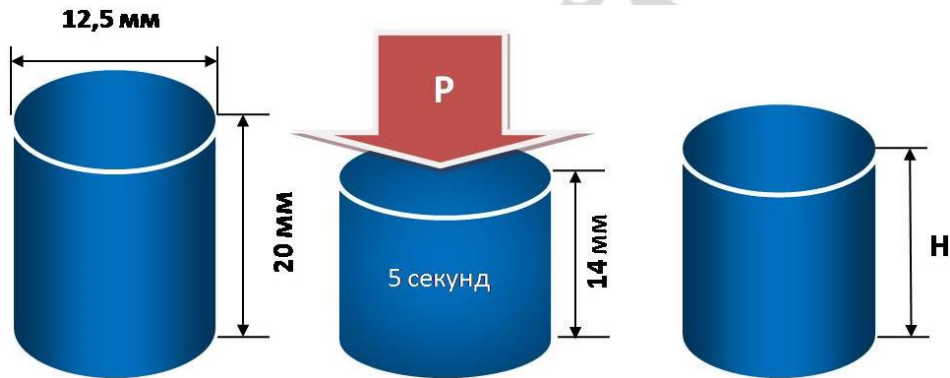

Fig. 7. The scheme of the impression material restoration after the compression deformation assessment

The difference of the elastic material sample height before the load and after it during the given period of time allows estimating the ability of the impression material to restore the initial sizes after deformation (recovery). Restoration of the material after compression deformation (**K**) is counted in percentage terms on the formula:

$$K = 100 - \left[100 \left(\frac{20 - H}{20} \right) \right],$$

where 20 is the initial height of the sample in millimeters.

WATER WETTABILITY OF THE IMPRESSION MATERIAL

On the border of the impression material contact with liquids a wetting phenomenon consisting in a curvature of a free liquid surface in relation to an impression material surface is observed. Wetting depends on a ratio of

attraction forces between molecules of solid bodies and liquids and forces of the intermolecular attraction in liquids. If the liquid molecules adjoining to the material interact with its molecules more strongly than among themselves, this liquid will seek to increase the contact surface with the material and to spread on it. If the interaction among the molecules of the liquid is more than liquid molecules with material, liquid seeks to reduce the contact surface with the impression material.

The phenomenon of wetting is characterized by a contact (regional) angle θ between the impression material surface and the meniscus of liquid (fig. 8).

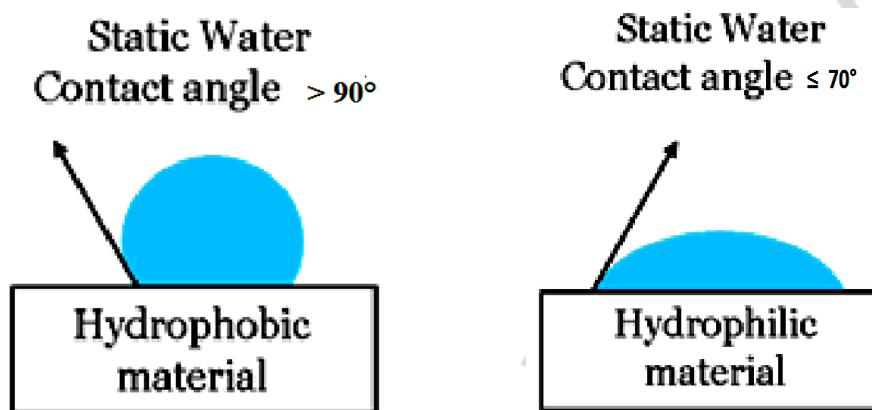

Fig. 8. The contact angles formed by water drops on surfaces of hydrophobic and hydrophilic impression materials

Impression materials on which surface the wetting liquid forms the contact angle of 70 and less degrees, are called *hydrophilic*. If on the contact border of the impression materials with the liquid the contact angle of 90 and more degrees is formed, such materials are called *hydrophobic*.

Receiving the impression is carried out in the conditions of the damp environment as in the oral cavity it is impossible to achieve absolute dryness of the prosthetic bed tissues. As the contact of the impression mass with the damp surface is inevitable, the material has to possess well balanced hydrophilicity. Otherwise the mass isn't able to force out moisture from the surface of the prosthetic bed that leads to pores in the impression sites. The impression material water wettability provides conveniences when casting the gypsum model, promoting gypsum to spread evenly on the impression surface.

MAIN PERIODS OF TIME USED IN THE WORK WITH IMPRESSION MATERIALS

The process of the impression receiving should be divided into three main periods of work: mixing time, working time and time of binding (hardening) of the material. In fig. 9 the main periods of jellification of irreversible hydrocolloid elastic alginate materials are given as an example (by ISO 1563:1990).

Mixing time includes part of the working time which is necessary for the impression preparation (receiving the mixture). Working time is the time available to mix components of the impression material, put it on the tray and

introduce into the oral cavity, i. e. the time period between the beginning of mixing and the beginning of binding (hardening) of the material. Time of binding (hardening) consists of the period of all work from the beginning of mixing till the full hardening and receiving the consistence necessary for the removal of the impression from the oral cavity with the minimum deformations.



Fig. 9. The main stages of work characterizing time for the impression material preparation and receiving impressions

RIGID IRREVERSIBLE IMPRESSION MATERIALS

GYPSUM

In general, the term “gypsum products” refers to various forms of calcium sulfate, hydrous and anhydrous, produced by the calcination of calcium sulfate dihydrate ($2\text{CaSO}_4 \cdot 2\text{H}_2\text{O}$), which occurs to be the mineral gypsum. Calcination can be controlled in order to produce partial or complete dehydration. Gypsum products can also be obtained by calcining “synthetic” or “chemical” gypsum, a byproduct of the manufacture of phosphoric acid. Industrially, all these materials are known as gypsum plasters.

Although not directly employed in dental restorations, gypsum products are important accessory materials used in many clinical and laboratory procedures. Their correct use contributes to the success of these procedures.

They are classified by the International Standards Organization (1998) into five types:

Type 1: Impression plaster.

Type 2: Plaster.

Type 3: Stone.

Type 4: Stone, high-strength, low-expansion.

Type 5: Stone, high-strength, high-expansion.

Gypsum products used in dentistry are formed by driving off part of the water of crystallization from gypsum to form calcium sulphate hemihydrate.

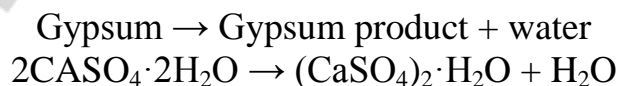

Calcium sulphate dihydrate \rightarrow Calcium sulphate hemihydrate

Applications of gypsum products in dentistry involve the reverse of the above reaction. The hemihydrate is mixed with water and reacts to form the dihydrate.



The various types of gypsum product used in dentistry are chemically identical, in that they consist of calcium sulphate hemihydrate, but they may differ in physical form depending upon the method used for their manufacture.

Type I plaster / Impression plaster:

It is used to make primary impression of edentulous oral cavity in complete denture fabrication. It is now replaced by elastomers and hydrocolloids as they are less rigid materials.

It is composed of plaster of Paris and is colored and flavored to make it more acceptable for the patient.

Few modifiers are added to regulate the setting time and expansion.

Plaster is produced by a process known as calcination. Gypsum is heated to a temperature of about 120 °C in order to drive off part of the water of crystallization. This produces irregular, porous particles which are sometimes referred to as β -hemihydrate particles (fig. 10). Overheating the gypsum may cause further loss of water to form calcium sulphate anhydrite (CaSO_4), whilst underheating produces a significant concentration of residual dihydrate. The presence of both components has a marked influence upon the setting characteristics of the resultant plaster.

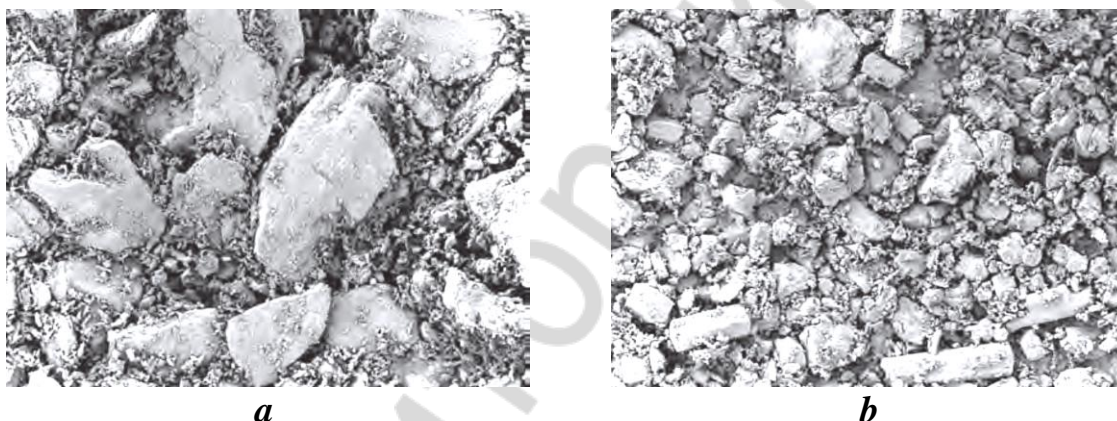

Fig. 10. Particles of calcium sulphate β -hemihydrate (a) and α -hemihydrate (b) (J. F. McCabe, A. W. G. Walls. Applied dental materials, ninth edition. Blackwell Publishing Ltd, 2008)

Properties. The impression plaster is easy to mix, but great care must be taken to avoid trapping air bubbles, as these will give rise to surface inaccuracies. The material has well-controlled working and setting characteristics, which are governed by the relative amounts of borax and potassium sulphate. The amount of potassium sulphate is generally more than would be found in model plaster, as, for impressions, the expansion must be kept to a minimum. Since the potassium sulphate also acts as an accelerator of the set, borax is needed to counteract it. The working time is of the order of 2–3 minutes, as is the setting time. The mixed material has very low viscosity, and so is mucostatic. It is hydrophilic and thus adapts readily to the soft tissues, recording their surface detail with great accuracy. The material is best used in a special tray, made of acrylic or shellac, to a thickness of 1.0–1.5 mm. Alternatively, it can be used as a wash with a compo special tray. The dimensional stability of impression plaster is very good, so a lime

delay in pouring the model is of no consequence, although extremes of temperature should be avoided. A separating medium (usually a solution of sodium alginate) must be used between the model plaster and the impression plaster. The material is rigid once set, and thus unable to record undercuts. This limits its application to the edentulous patient. From the patient's point of view it is not an unpleasant material, although it tends to leave a sensation of dryness in the mouth for some time after the impression has been taken. In fig. 11 mixing of impression plaster is shown.

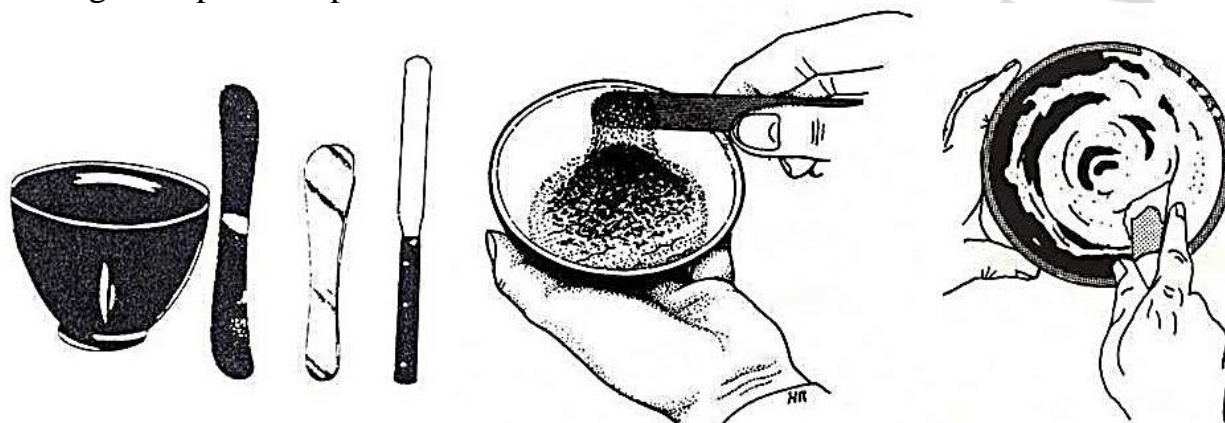

Fig. 11. Mixing of impression plaster with water

ZINC OXIDE-EUGENOL

Applications:

- Cementing and insulating medium.
- Temporary filling.
- Root canal filling material.
- Bite registration paste.
- Impression material for edentulous patients.
- Temporary relining material for dentures.

ZOE are available as:

- base paste (white in color);
- accelerator (or reactor or catalyst) paste (red in color) (fig. 12).

Composition of base and accelerator pastes is shown in the table 2.

Table 2

Composition of base paste and accelerator paste

Base paste	Accelerator paste
Zinc oxide — 87 %	Eugenol — 12 %
Fixed vegetable oil or mineral oil — 13 %	Gum — 50 %
	Filler(silica) — 20 %
	LANOLIN — 3 %
	Resinous balsam — 10 %
	Accelerator solution (calcium chloride) — 5 %



Fig. 12. Zinc oxide eugenol material produced in 2 pastes (base paste and accelerator paste)

Setting reaction:

- Setting reaction is an acid base reaction to form a chelate.
- This reaction is also known as *chelation* and the product is called *zinc eugenolate*.

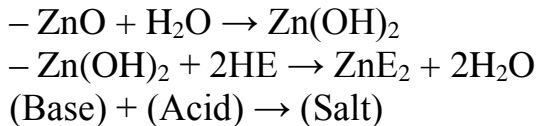

Setting time:

- initial setting time: type I — 3–6 min; type II — 3–6 min;
- final setting time: type I — 10 min; type II — 15 min.

Factors controlling setting time:

- Particle size of zinc oxide powder.
- Longer mixing time, shortens setting time.
- High atmospheric *temperature* and *humidity* accelerate setting.
- Setting can be delayed by cooling mixing slab, spatula or adding small amount of retarder or oils or waxes.

Properties:

- Good consistency and flow.
- Detail reproduction.
- Rigid and having good strength.
- Good dimensional stability.

Manipulation (fig. 13):

- Mixing is done on an oil-impervious paper or glass slab.
- Two ropes of paste of same length and width are squeezed on mixing slab.
- A flexible stainless steel spatula is used for mixing.
- Two ropes are combined until a uniform color is obtained.
- Mechanical rotary mixing are also used.
- Mixing time is one minute.



Fig. 13. Mixing of ZOE pastes

Advantages:

- It has enough working time to complete border moulding.
- It can be checked in mouth repeatedly without deforming.
- It registers accurate surface details.
- It is dimensionally stable.
- Does not require separating media since it does not stick to cast material.
- Minor defects can be corrected.

Disadvantages:

- Requires special tray for impression making.
- Sticky in nature and adheres to tissues.
- Burning sensation of eugenol causes tissue irritation.
- Highly inelastic in nature.

There is also non-eugenol paste.

- It is developed to overcome the burning sensation caused by eugenol.
 - Bactericides and other medicaments are also incorporated.
- Used in eugenol irritant patients.

RIGID REVERSIBLE IMPRESSION MATERIALS**THERMOPLASTIC COMPOUNDS**

- Impression compound is rigid, reversible impression material set by physical change (fig. 14).
- It softens on heating and hardens on cooling.
- ADA specification no 3.
- Supplied as sheets, sticks, cakes and cones.



Fig. 14. Thermoplastic compounds:

a — thermoplastic compound; *b* — plasticity giving to the thermoplastic compound by its immersion in a flask with the water warmed up till 50–60 °C

The use of compounds:

1. Making preliminary impression of edentulous mouth.
2. For individual tooth impression.
3. To make a special tray.
4. Border moulding.
5. To check undercuts in inlay preparations.

Properties of compounds:

- Glass transitional temperature =39 degree centigrade.
- Fusion temperature=43.5 degree centigrade.
- They are poor conductors of heat.
- Coefficient of Linear Expansion is high.
- Good flow.
- Fine reproduction of detail.

Composition of compounds (by Charles Stent, produced since 1860 till nowadays) is presented in the table 3.

Table 3

Composition of compounds

Ingredients	Parts
Pine resin	36 %
Paraffin	12,98 %
Ceresin	5,5 %
Zinc oxide	3 %
Talc	42 %
Dibutylphthalate	0,5 %
Dye	0,02 %

As a rule compounds have their advantages and disadvantages.

Advantages are:

- Material can be reused several times.
- Inaccurate portions can be remade without having to remake the entire impression.
- Accuracy can be improved by flaming surface material.

Disadvantages:

- Distortion due to poor dimensional stability.
- Compress soft tissue while making impression.
- Difficult to remove if there are undercuts.
- Difficult to record details because of high viscosity.

ELASTIC REVERSIBLE IMPRESSION MATERIALS

AGAR-AGAR HYDROCOLLOID

Agar hydrocolloids have been largely replaced by rubber impression materials but are still used for full-mouth impressions without deep undercuts, quadrant impressions without deep undercuts, and single impressions (less frequently). They can be used for fixed partial denture impressions because of their high accuracy.

Composition. Agar hydrocolloids are available in both tray and syringe consistencies. The material is supplied as a gel in plastic tubes (fig. 15, a) and contains agar (12 % to 15 %) as a gelling agent, borax (0.2 %) to improve strength, potassium sulfate (1 % to 2 %) to provide good surfaces on gypsum

models or dies, alkylbenzoates (0.1 %) as preservatives, and coloring and flavoring agents (traces) for ease of “reading” the impression and esthetics. The balance of the formulation (~85 %) is water. The syringe consistency is prepared by increasing the water content and decreasing the agar content. The material, supplied as a solid gel, can be converted to a sol (liquid) by heating; cooling a sol causes it to become the gel.

The gel-to-sol and sol-to-gel transformations depend on time and temperature. The liquefaction and gelation temperatures are different (the latter being lower), and the effect is called hysteresis. A typical value of the gelation temperature is 43 °C. They are highly elastic (98.8 %) and sufficiently flexible (11 %) to give accurate impressions of teeth with undercuts. They are stronger when stressed quickly; therefore, rapid removal is recommended.



Fig. 15. *a* — agar-agar hydrocolloid; *b* — water bath for preparing of the agar-agar hydrocolloid

Manipulation. Agar requires a special water bath with three chambers for heating (fig. 15, *b*) and water-cooled trays. The following sequence is used:

1. Heat in water at 100 °C for 8 to 12 minutes.
2. Store in water at 65 °C.
3. Place in a tray (containing cooling coils) at 65 °C.
4. Temper in 46 °C water for 2 minutes before taking the impression.
5. After setting the tray, cool it with water at no less than 13 °C until gelation occurs.
6. After the impression is removed from the mouth, wash it to remove saliva, which will interfere with the setting of the gypsum.
7. Shake off excess water and lightly blow off with air.
8. Disinfect the impression.
9. Pour mixed dental stone into the impression. If the impression is stored for a short time in 100 % relative humidity, it should be washed as described in steps 6 and 7 to remove any exudate on the surface caused by syneresis (the exudation of water, accompanied by contraction) before pouring the model.
10. After the initial setting of the stone, store the gypsum model and impression in a humidior.

Agar impressions become less accurate during storage, and prompt pouring of gypsum casts is necessary. If agar impressions must be stored, the minimum changes in dimensions are found upon storage in 100 % relative humidity for no longer than 1 hour. However, the gel structure can absorb water, a process called imbibition, which is usually accompanied by expansion. Agar materials have a long working time.

Handling, however, offsets this convenience because of the need for storage tanks. Gelation, produced by circulating cool water through the special trays, also requires special equipment. Thermal shock, produced by suddenly cooling the warm colloid, may be painful to patients who have metallic restorations.

Contact with agar retards the setting of gypsum, resulting in dies and casts with poor surface finish. With older products, soaking the impression in a 2 % potassium sulfate solution was necessary to achieve a smooth surface finish. Most agar products now contain potassium sulfate, which acts as an accelerator for the gypsum setting reaction, and soaking is no longer necessary.

Advantages. Agar impression materials are inexpensive, have no unpleasant odors, and are nontoxic and nonstaining. They do not require a custom tray or adhesives, and the components do not require mixing. These materials are hydrophilic and can be used in the presence of moisture, are able to displace blood and body fluids, and are easily poured in stone. The stone casts are easily removed from the hydrocolloid impressions.

Disadvantages. These materials require the use of expensive equipment and must be prepared in advance. They tear easily, must be poured immediately, are dimensionally unstable, can only be used for single casts, and cannot be electroplated. The surface of stone casts will be weakened by compositions containing borax.

Troubleshooting. Sometimes problems of distorted impressions or loss of detail may be encountered when using agar hydrocolloids.

The following are factors that could lead to distortion:

1. *Slow removal from the mouth.* To avoid permanent deformation, the impression should be removed with a quick jerk.

2. *Removal from the mouth before the gel reaches a temperature of 37 °C or less.* Above this temperature the impression material will still be plastic. The cooling rate of hydrocolloid is dependent on the temperature of water circulating through the tray.

3. *Cooling water that is too cold 13 °C.* Rapid cooling of the impression may cause a concentration of internal stresses that may be subsequently released.

4. *Application of force on the tray during gelation.* After the load is removed, relaxation of stresses will occur.

5. *Delay in pouring the cast.* Waiting any length of time to pour the cast will result in shrinkage of the impression due to the loss of water.

6. *Instability of tray.* If there is loss of detail, it may be caused by movement of the tray before gelation is complete. Failure to keep the impression stabilized will result in a multiple impression of the oral structures.

Disinfection. Agar hydrocolloids can be disinfected by immersion in sodium hypochlorite, iodophors, or phenolic glutaraldehydes. The manufacturer's recommendations for proper disinfection should be followed.

ELASTIC IRREVERSIBLE IMPRESSION MATERIALS

ALGINATE HYDROCOLLOID

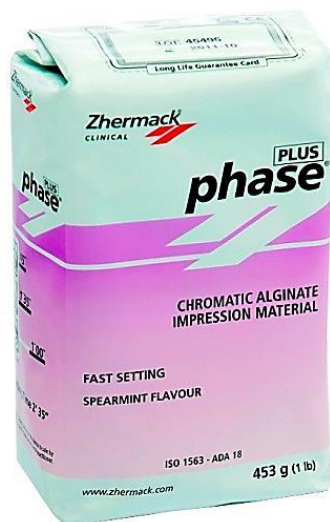
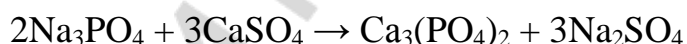

Fig. 16. Alginate hydrocolloid material

Alginates are the most widely used impression materials in dentistry. They are used for making impressions for removable partial dentures with clasps, preliminary impressions for complete dentures and orthodontic and study models. They are not accurate enough for fixed partial denture impressions.

Composition. Alginates are supplied as a powder (fig. 16) containing sodium or potassium alginate (12 % to 15 %) and calcium sulfate dihydrate (8 % to 12 %) as reactants; sodium phosphate (2 %) as a retarder; a reinforcing filler (70 %), such as diatomaceous earth, to control the stiffness of the set gel; potassium sulfate or alkali zinc fluorides (~10 %) to provide good surfaces on gypsum dies; and coloring and flavoring agents (traces) for esthetics. The sodium phosphate content is adjusted by the manufacturer to produce either regular- or fast-set alginates. The powder is mixed with water to obtain a paste. Two main reactions occur when the powder reacts with water during setting.

First, the sodium phosphate reacts with the calcium sulfate to provide adequate working time:



Second, after the sodium phosphate has reacted, the remaining calcium sulfate reacts with the sodium alginate to form an insoluble calcium alginate, which forms a gel with the water:

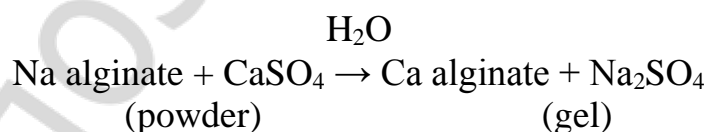

To avoid the inhalation of alginate dust, some materials have been introduced in a dustless version in which the powder is coated with a glycol (Identec Dust Free, Cadco; Jeltrate Plus, Caulk).

Some products contain a chemical disinfectant in the alginate powder due to the concern for infection control (Coe Hydrophilic Gel, GC America; Identec Dust Free; Jeltrate Plus). Two examples of these disinfectants are didecyl-dimethyl ammonium chloride and chlorhexidine acetate. When the quaternary ammonium compound is used, the detail reproduction and gypsum compatibility of

the alginate improve. However, the impressions made from these materials should still be disinfected upon removal from the mouth.

Mechanical properties . Alginates have elastic recovery of 97.3 %, which indicates less elasticity and therefore less accuracy than agar hydrocolloids and silicone and polyether impression materials. The compressive and tear strengths increase with increasing rates of deformation. As the limit of reproduction is also lower, less fine detail will be obtained. Fig. 17 shows change of water weight content in alginate impression materials at impression storage in the water, at 100 % humidity and on air within 24 hours, in %.

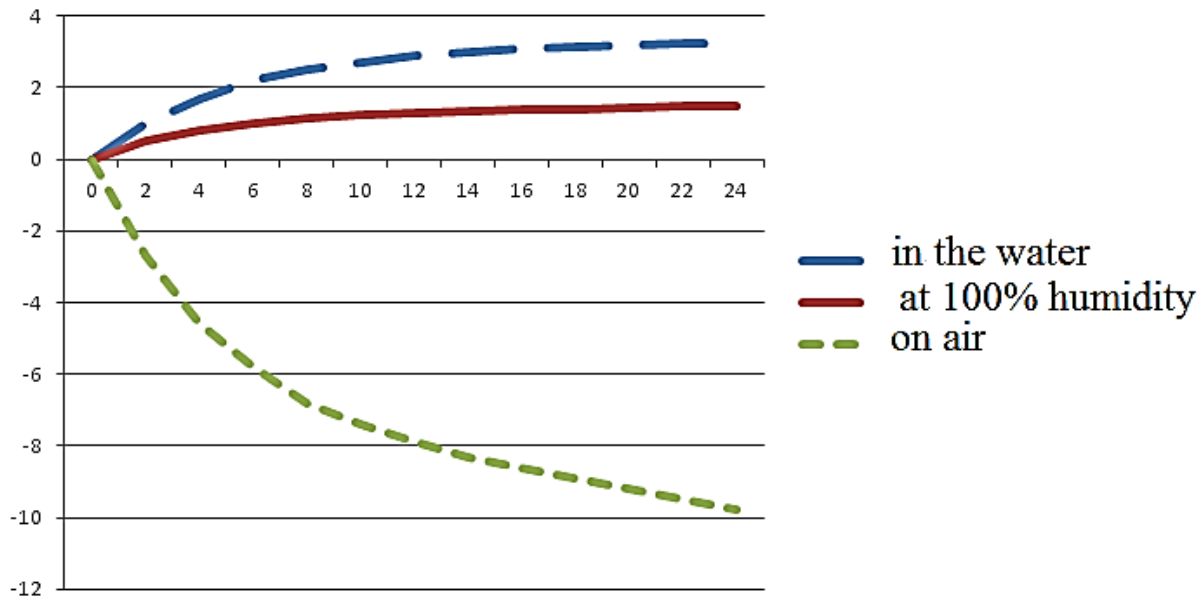

Fig. 17. Percentage change of water weight content in alginate impression materials at impression storage in the water, at 100 % humidity and on air within 24 hours

Manipulation (fig. 18). Although easy to use, care is required in handling alginate hydrocolloids. The powder, supplied in a can, should be shaken up for aeration and one scoop of powder is used for one measure of water. A powder scoop and a graduated cylinder for water are usually supplied with the product. With predispensed powder products, one packet of powder is used with the amount of water specified by the manufacturer. A lower W/P ratio increases strength, tear resistance, and consistency, and decreases working and setting times and flexibility. Cooling the water increases the working and setting times. Insufficient mixing results in a grainy mix and poor recording of detail. Adequate spatulation gives a smooth, creamy mix with a minimum of voids. One minute of thorough mixing for the regular-set material and 45 seconds for the fast-set material are generally recommended. Alginates have a relatively short working time of about 2.5 minutes and set about 3.5 minutes after mixing. Alginates are as unstable as agar hydrocolloids, because both are gels, and they undergo shrinkage or expansion when water is lost or gained. Storage in either air or water results in significant dimensional change; however, storage at 100 % humidity results in the least dimensional change. Therefore, the cast should be poured soon after

removal of the impression and cleaning. Alginates, like agar, retard the setting of the gypsum model and die materials when in contact. Potassium sulfate is added by the manufacturer to accelerate the setting of the gypsum and to obtain smooth model and die surfaces. An alginate tray material can be combined with an agar syringe material to prepare impressions. These impressions take advantage of the agar hydrocolloid's detail reproduction and compatibility with gypsum qualities and at the same time minimize equipment needs. A simple heater can be used to prepare the syringe material, and the water-cooled trays are no longer necessary. The alginate is placed in a tray, the agar is syringed around the preparation, and then the alginate is seated on top of the agar.

Care must be taken to select an agar-alginate impression pair with suitable bond strengths. It is best to select combinations recommended by the manufacturers. Best results are obtained when single-unit impressions are made by this technique.

Advantages. Alginate impression materials are inexpensive, easy to manipulate, pleasant tasting, able to displace blood and body fluids, hydrophilic, and easily poured in stone. They can be used with stock trays.

Disadvantages. Alginates tear easily, must be poured immediately after removal from the mouth, have limited detail reproduction, are dimensionally unstable, and can only be used for single casts. The gypsum compatibility varies with the brands of alginates and dental stones used. They are incompatible with many epoxy resin die materials.

Troubleshooting. Problems may sometimes be encountered when using alginate hydrocolloids. The following should serve as a guide for troubleshooting problems with these materials:

1. *Inadequate working or setting time.* The temperature of the mixing water may be too high. Generally, the temperature of the water should range between 18 °C and 24 °C. If the mixture is incompletely spatulated, it may be inhomogeneous and may set prematurely. Under normal conditions, adequate spatulation requires 45 to 60 seconds. If the W/P ratio is too low as the result of incorrect dispensing, the setting time could be too fast. Improper storage of the alginate powder can result in deterioration of the material and shorter setting times.

2. *Distortion.* If the tray moves during gelation or if the impression is removed prematurely, the result will be a distorted impression. The amount and duration of compression should be considered. It is important, therefore, to remove the impression from the mouth rapidly. Since the weight of the tray can compress or distort the alginate, the impression should not be placed face down on the bench surface. If the impression is not poured immediately, distortion could occur.

3. *Tearing.* If the impression tears, it is possible that the impression was removed from the mouth before it was adequately set. Wait 2 to 3 minutes after loss of tackiness to remove the impression for development of adequate tear strength. Also, the rate of removal from the mouth may be a factor. Since the tear strength of alginate increases with the rate at which a stress is applied, it is desirable to rapidly remove the impression from the mouth. In addition, thin mixes

are more prone to tearing than those with lower W/P ratios. The presence of undercuts also can produce tearing. Blocking out these areas will place less stress on the impression material during removal. It is also possible that there is not enough impression material; there should always be at least 3 mm of material between the tray and the oral tissues.

4. *Loss of detail.* If there is loss of detail, the impression may have been removed from the mouth prematurely. Multiple impressions of the oral structure will result if the material is still in the plastic state when removed.

5. *Consistency.* If the preset mix does not have the proper consistency (is either too thick or too thin), the W/P ratio is incorrect. Care must be taken to fluff the powder before measuring and not to overfill the powder dispenser. Vigorous spatulation and mixing for the full recommended time is required to avoid consistency problems caused by inadequate mixing. If hot water is used, the mix may become grainy and prematurely thick.

6. *Dimensional change.* If dimensional change is a problem, a delay in pouring the impression might be the cause. Such delays will result in a cast that is distorted as well as undersized, because alginate impressions lose water when stored in air.

7. *Porosity.* The impression can be porous as the result of whipping air into the mix during spatulation. After the powder has been wetted with the water, the alginate should be mixed so as to squeeze the material between the spatula blade and the side of the rubber bowl.

8. *Poor stone surface.* If the set gypsum remains in contact with the alginate for too long, the quality of the stone surface will suffer.

Disinfection. Alginate hydrocolloids can be disinfected by immersion in sodium hypochlorite or iodophors. The manufacturer's recommendations for proper disinfection should be followed.

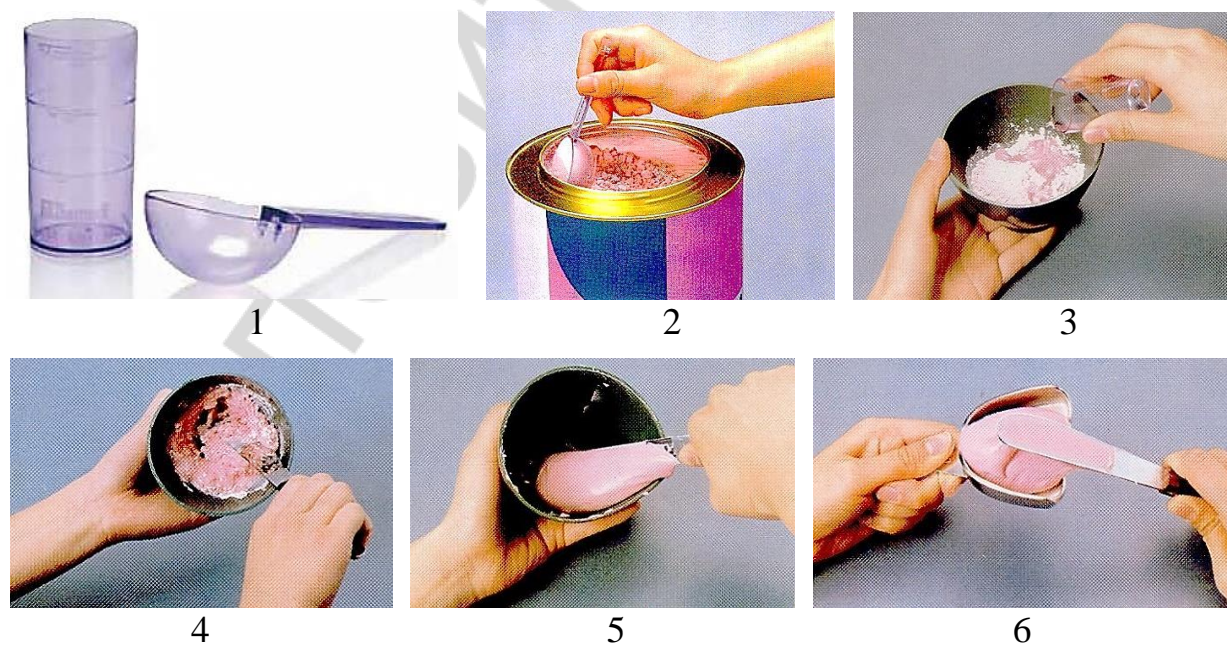

Fig. 18. Sequence of the alginate impression material preparation

NONAQUEOUS ELASTOMERIC IMPRESSION MATERIALS

The impression materials discussed so far are not good enough generally for taking accurate impressions of the dental patient. The alginates are inherently weak materials and provide poor reproduction of surface detail; agar is dimensionally unstable and only suitable if laboratory facilities are close at hand; and the rigid impression materials cannot be removed from deep undercuts. Thus, there is still a need for an impression material that is accurate, that shows a large recoverable deformation, and has adequate long-term dimensional stability. These goals can all be met with the elastomeric impression materials.

The elastomeric impression materials are characterized as polymers that are used at a temperature above their glass transition temperature. Such materials become more and more fluid as their temperature is raised above their glass transition temperature, T_g .

The viscosities of the polymers that are used for impression materials are governed primarily by the molecular weight of the polymer (i. e. the length of the polymer chains) and by the presence of additives, such as fillers. Thus, we have a material that is fluid at room temperature, but that can be turned into a solid by binding the long-chain molecules together. This process of binding the chains to form a three-dimensional network is known as cross-linking and forms the basis of the liquid-to-solid transition of all the elastomeric impression materials. There are essentially three main groups of elastomeric impression materials:

- polysulphides
- polyethers
- silicones (C-type and A-type).

Each group of the elastomers is classified according to its viscosity. In the table 4 viscosity types of the elastomeric impression materials are presented.

Table 4

Types of the elastomers (ISO4823:1992)

Type (ISO)	Viscosity	Characteristic of viscosity (a disc diameter in mm)
0	(P) putty	≤ 30
1	(H) high	≤ 35
2	(M) middle	31–36
3	(L) low	36 <i>min</i>

Polysulfide rubber (mercaptan)

Polysulfide rubbers are widely used for fixed partial dentures, due to their high accuracy and relatively low cost. These materials are useful for multiple impressions when extra time is needed. The polysulfides are supplied in tubes of base paste and catalyst paste, which are mixed together (fig. 19). Polysulfides are available in low, medium, and high viscosities.

Composition. The base paste contains the polysulfide polymer, fillers, and plasticizers. The content of the reinforcing fillers (eg, zinc oxide, titanium dioxide, zinc sulfide, and silica) varies from 12 % to 50 % depending on the consistency

(light, regular, or heavy). The fillers and plasticizers control the stiffness of the paste. The accelerator or catalyst paste contains lead dioxide (30 %), hydrated copper oxide or organic peroxide, as a catalyst; sulfur (1 % to 4 %) as a promoter; and dibutyl phthalate or other nonreactive oils (17 %) to form a paste. The balance of the catalyst paste is inorganic fillers used to adjust the consistency and reactivity. Those materials containing an organic peroxide may have decreased dimensional stability due to evaporation of the peroxide. Note that this is a condensation polymerization with water as a by-product.



Fig. 19. Polysulfide rubber (mercaptan)

Mechanical properties. For elastic recovery, the polysulfides have values of about 96 %, slightly lower than those for the other rubber impression materials (eg, silicone and polyether). Values for flow range from 0.4 % to 1.9 %, indicating a tendency to distort upon storage. The flow tends to be the highest for the light-bodied and the least for the heavy bodied materials. Light-bodied polysulfides have flexibilities of about 16 %; regular bodied polysulfides have values of about 14 %; and heavy-bodied polysulfides have values of about 10 %. This is an advantage over the stiffer addition silicones and polyethers because removal from undercut areas is easier. Polysulfides have the highest tear strength of the rubber materials, which allows their use in deep subgingival areas where removal is difficult.

Manipulation. These materials are mixed on a mixing pad with a spatula. Equal lengths of base and catalyst are extruded on a disposable mixing pad. The components are mixed thoroughly with a stiff tapered spatula. The catalyst is dark and the base is white so thorough mixing is readily observed by lack of streaks in the mix. Adequate mixing time is 45 to 60 seconds. The working time is about 5 to 7 minutes, which is adequate considering the mixing times. Both working and setting times are shortened by higher temperatures and humidity. A value of 0.45 % is given for shrinkage after 24 hours. Although this is less than

that of the condensation silicones, the cast or die should be poured within 1 hour of taking the impression. Since polysulfides take longer to set than silicones, they require more chair time. They stain clothing permanently. They can be electroplated; some products can be silverplated, but copperplating is not recommended.

Advantages. Advantages of polysulfides include a long working time, good tear strength, good flow before setting, good reproduction of surface detail, high flexibility for easier removal around undercuts, and lower cost compared to silicones and polyethers.

Disadvantages. Disadvantages of these materials include the need to use custom-made rather than stock trays due to a greater chance of distortion, a bad odor, a tendency to run down the patient's throat due to lower viscosity, and the lead dioxide materials that stain clothing. Polysulfides must be poured within 1 hour and cannot be repoured.

Troubleshooting. Sometimes problems may be encountered when using polysulfide rubber impression materials:

1. *Inadequate working time.* This could result from excessive humidity and/or temperature. An increase in either of these variables results in decreased working and setting times. An improper base-to-catalyst ratio could also produce inadequate working time (too much catalyst will reduce working time).

2. *Distortion.* A number of factors cause distortion, one of which is too much load. Because recovery after deformation depends on the amount and duration of load, the impression should not be placed face down on the laboratory bench. Improper removal from the mouth could also cause distortion of the impression; removal should be rapid because permanent deformation is a function of duration of stress. If a bubble is located just below the surface, adjacent to a preparation (internal porosity), the impression may be distorted.

3. *Loss of detail.* Premature removal from the mouth may be a cause of this. Removal prior to sufficient polymerization or before the material is sufficiently elastic will result in inaccurate registration of detail. This may also be the result of incomplete mixing; failure to incorporate all the catalyst into the base will result in incomplete polymerization of portions of the surface. Movement of the tray prior to the time of removal could also cause loss of detail. The impression tray should be held firmly until the elastic stage is attained.

4. *Surface bubbles or voids.* These could be caused by the incorporation of air into the mix. The impression material should always be mixed carefully with only the flat surface of the blade. If the material is partially polymerized prior to insertion in the mouth, voids may occur in the impression.

Disinfection. Polysulfide impressions can be disinfected by immersion in sodium hypochlorite, iodophors, complex phenolics, glutaraldehydes, or phenolic glutaraldehydes. The manufacturer's recommendations for proper disinfection should be followed.

Silicone rubber condensation type

Condensation silicone rubber impression materials are used mainly for fixed partial denture impressions. They are ideal for single-unit inlays. These materials are supplied either as two-paste or paste-liquid catalyst systems. Condensation silicones are available in low (fig. 20, *b*), medium, high, and very high (putty) (fig. 20, *a*) viscosities.

Composition. The base paste usually contains a moderately high-molecular-weight poly (dimethylsiloxane) with terminal hydroxy groups (-OH), an orthoalkylsilicate for cross-linking, and inorganic filler. A paste will contain 30 % to 40 % filler, whereas putty will contain as much as 75 %. The catalyst paste (fig. 20, *c*) or liquid usually contains a metal organic ester, such as tin octoate or dibutyl tin dilaurate, and an oily diluent. A thickening agent is used when making catalyst pastes. Sometimes a catalyst will contain both the orthoalkylsilicate and the metal organic ester. A volatile alcohol is formed as a by-product.



Fig. 20. Silicone condensation type 0 viscosity type (*a*), 3 viscosity type (*b*), and universal catalyst (*c*)

Mechanical properties. Accepted values for the mechanical properties of these materials are given in an average value of 99 % for the elastic recovery. The flow of silicones is low; most values are less than 0.1 %. The silicones are stiffer than polysulfides, as indicated by lower flexibility values in the shrinkage in 24 hours ranges from 0.2 % to 1.0 %. About half of the shrinkage takes place in the first hour, and it is greater than for polysulfides or polyethers. Polymerization and evaporation of the alcohol formed in the reaction are responsible for this high shrinkage. Accuracy is greatly improved by first taking an impression with a highly filled silicone putty and, after setting, taking a second impression with a light-bodied silicone. Thus, the final total shrinkage is lower.

Manipulation. The manipulation of condensation silicones is the same as for polysulfides, but the silicone material may be supplied as a base paste plus a liquid catalyst (fig. 21, 22).

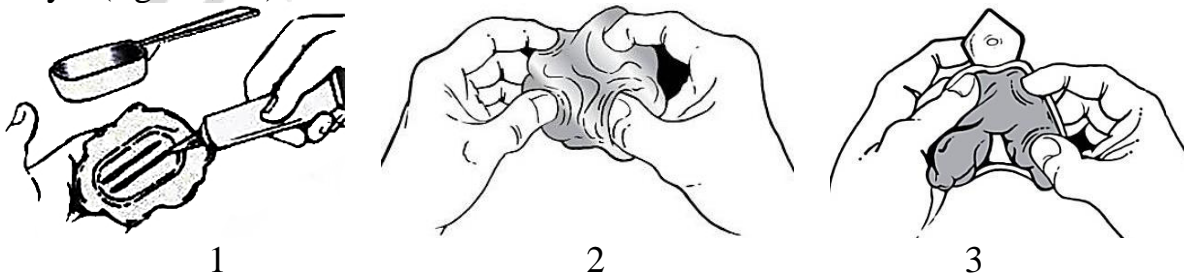

Fig. 21. Sequence of hand mixing of silicone condensation type, 0 and 1 viscosity types.

When it is supplied in this form, one drop per inch of extruded base paste is usually recommended. The setting time (6 to 8 minutes) is less than that of the polysulfides, which offers some advantage in chair time savings. Electroplating is possible. Because of the high polymerization shrinkage, the cast or die must be poured as soon as possible. Higher temperatures and humidity shorten the setting time.

Advantages. Condensation silicones are clean, pleasant materials for the patient. They are highly elastic, and the setting time can be controlled with the amount of accelerator. The use of a putty-wash system improves accuracy and eliminates the need for a custom tray.

Disadvantages. These materials tend to be inaccurate due to shrinkage on standing and should be poured within 1 hour. They are very hydrophobic, require a very dry field, and are difficult to pour in stone.

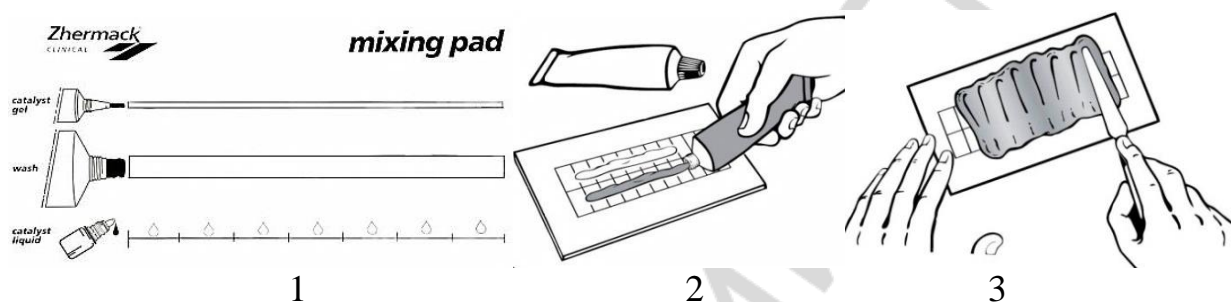

Fig. 22. Sequence of hand mixing of silicone condensation type, 2 and 3 viscosity types

Troubleshooting

1. *Inadequate working time.* This could result from excessive humidity and/or temperature. Although not as critical as polysulfide rubber, the setting times of silicone impression materials are influenced by temperature and humidity. Increases in these conditions tend to shorten both working and setting times. An improper base-to-catalyst ratio could also produce inadequate working time. Insufficient catalyst will result in prolonged setting times. Failure to polymerize in the predicted time may result from deterioration during storage.

2. *Distortion.* This may result from incorrect separation from impressed structures. Failure to remove the impression in a rapid, jerking motion may cause the impression to become permanently deformed. An impression can also become distorted if there is inadequate support of the impression after removal from the mouth. It may undergo permanent deformation if allowed to rest face down on the bench. Excessive delay in pouring the cast (30 minutes or more) also may result in dimensional changes. Possible shrinkage may result from continued polymerization and vaporization of volatiles in the silicone rubber. This shrinkage can be compensated for by use of the double impression technique. A preliminary impression is made with a very high viscosity material (putty), providing space for the final impression, which is made with a low-viscosity material using the preliminary impression as the tray.

3. *Loss of detail.* Premature removal of the impression from the mouth could cause loss of detail. Failure to allow the impression material to set adequately will

result in plastic deformation. Loss of detail also can be caused by incomplete mixing. Failure to adequately incorporate all the catalyst into the base will result in incomplete polymerization. Loss of detail can also result from movement of the tray after the impression has been seated. Failure to maintain the tray in a stable position will result in a blurred impression.

Disinfection. Condensation silicone impressions can be disinfected by immersion in sodium hypochlorite, iodophors, complex phenolics, glutaraldehydes, or phenolic glutaraldehydes. The manufacturer's recommendations for proper disinfection should be followed.

Silicone rubber addition type

Addition silicones represent an advance in accuracy over condensation silicones. This has been achieved by a change in polymerization reactions to an addition type and the elimination of an alcohol by-product that evaporates, causing shrinkage. These materials are available as two-paste systems in four viscosities light, medium, heavy, and putty and a range of colors, allowing monitoring of the degree of mixing (fig. 23). Addition silicones can be produced in cartridges and mixed automatically (fig. 24). Due to their high accuracy, these materials are suitable for fixed and removable partial denture impressions. They are rigid after setting and expensive, and therefore are not used for routine study models. Hydrophilic materials have been introduced that reportedly contain surfactants to improve the wetting characteristics compared to unmodified silicones. Monophase materials have been formulated with sufficient shear thinning to be used as both low-viscosity and high-viscosity materials.

Composition. These materials are based on silicone prepolymers with vinyl and hydrogen side groups, which can polymerize by addition polymerization. They are therefore called vinyl or addition silicones. The setting reaction is produced by mixing one paste containing the vinyl-poly(dimethylsiloxane) prepolymer with a second paste that contains a siloxane prepolymer with hydrogen side groups. Other reactions also occur that may release hydrogen gas, which on rare occasion can produce porosity. Some manufacturers include hydrogen absorbers in their formulations to eliminate this problem. Since no volatile by-products are produced in the reaction, addition silicones have a much greater dimensional stability than condensation silicones. Some manufacturers include a retarder for extending the working and setting times.



Fig. 23. Silicone addition type for hand mixing (1) and automatic mixing (2)

Mechanical properties. The working and setting times of addition silicones are faster than that of polysulfides; a retarder is often supplied to extend the working time. Addition silicones have excellent elasticity and show very low dimensional shrinkage upon storage. Therefore, addition silicones can be safely poured up later or sent to a dental laboratory. Addition silicones do have greater rigidity, however, and therefore it is difficult to remove the impression around undercuts, as indicated by the lower flexibility value. The tear strength of addition silicones is similar to that of condensation silicones, but less than that of polysulfides.



Fig. 24. Silicone addition type in cartridges (a) and general view of the mixer for cartridges (b)

Manipulation (fig. 25). Addition silicones are as pleasant to handle as condensation silicones. Because there is the possibility of hydrogen release upon setting, finely divided palladium is added to some products to absorb the hydrogen and prevent bubbles from forming on stone die surfaces. If a product does not contain a hydrogen absorber, an hour should pass before pouring dies, and the impression should stand overnight before epoxy dies are poured. Addition silicones can be electroplated with both copper and silver. Automatic mixers that provide quick, bubble-free mixes are available with several products (fig. 26).

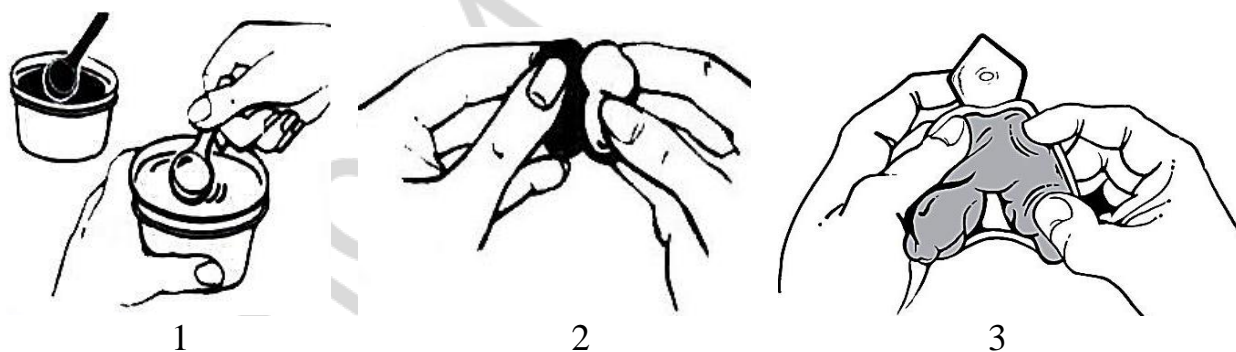

Fig. 25. Sequence of a silicone addition type of 0 and 1 viscosity type hand mixing

Advantages. Addition silicones are highly accurate and have high dimensional stability after setting. Recovery from deformation on removal is excellent. The material stays in the tray of reclined patients, does not stain clothing, has pleasant colors and scents, may be used with stock or custom trays, and can be copper- or silver- plated. The materials may be poured in a week after taking the impression, and multiple pours are possible.



Fig. 26. Devices for automatic mixing of nonaqueous elastomeric impression materials 0 and 1 types of viscosity:

a — Pentamix 3 (3M ESPE); *b* — Dispenser (Dentsply); *c* — Dispenser Plug&Press (Kettenbach); *d* — Flextime Dynamix (Heraeus); *e* — Mixstation (Cosmedent); *f* — MixStar Motion (DMG); *g* — Volume Mixer (Kerr); *h* — Modulmix (Zhermack)

Disadvantages. The disadvantages are that the material is twice as expensive as the polysulfides; is more rigid than condensation silicones and difficult to remove around undercuts; has a moderate tear strength, making removal from gingival retraction areas somewhat risky; and may release hydrogen gas on setting, producing bubbles on die surfaces if an absorber is not in the product. Hydrophobic materials are difficult to electroplate and to pour in stone. Also, sulfur in latex gloves and rubber dams can inhibit polymerization.

Troubleshooting

1. *Inadequate working time.* This can result from excessive temperature. As the temperature increases, the working and setting times decrease. If the impression material does not set, the catalyst may have been contaminated. The platinum containing catalyst becomes inactive after contacting certain substances, such as tin or sulfur compounds. If addition silicones are combined with condensation silicones, the material will not set. Components from these two systems are not compatible and cannot be mixed together.

2. *Loss of detail.* This could occur if unmodified addition silicones are used. These hydrophobic materials cannot displace any moisture or hemorrhage that is not removed prior to placement of the impression material.

3. *Porosity.* The stone surface may appear porous if hydrogen gas is evolved. If this is the case, it is recommended that the pouring of dies must be delayed for at least 1 hour.

4. *Distortion*. This may occur if the polysiloxane adhesive does not provide adequate retention. Mechanical retention may be required in combination with the adhesive.

Disinfection. Addition silicone impressions can be disinfected by immersion in sodium hypochlorite, iodophors, complex phenolics, glutaraldehydes, or phenolic glutaraldehydes. The manufacturer's recommendations for proper disinfection should be followed.

Polyether rubber

Polyether rubbers are used for accurate impressions of a few prepared teeth without severe undercuts. Their high stiffness and short working time restricts their use to impressions of a few teeth. Polyethers are available in low-, medium- and high-viscosity materials.

Composition. Polyethers are supplied as two-paste systems (fig. 27). The base paste contains low-molecular weight polyether with ethylene-imine terminal groups, along with fillers, such as colloidal silica, and plasticizers. The catalyst paste contains an aromatic sulfonic acid ester plus a thickening agent to form a paste along with fillers. When the base paste is mixed with the catalyst paste, ionic polymerization occurs by ring opening of the ethylene-imine group and chain extension. The reaction converts the paste to the rubber.



Fig. 27. Polyether impression material

Mechanical properties. Polyethers are similar to addition silicones in properties. The early polyethers had short working and setting times and low flexibilities. Thinners were available to increase the working time and flexibility without any significant loss of other physical or mechanical properties. However, more recent formulations have a working time of 2.5 minutes and a setting time of 4.5 minutes. Shrinkage values of 0.3 % in 24 hours place the polyethers at the upper end of the range for accuracy, but inferior to some addition silicones. Because this rubber absorbs water and changes dimensions, storage in water is not recommended. Elastic recovery values average 98.5 %, between those for polysulfides and addition silicones. The flow of polyethers is very low and contributes to accuracy. The flexibility also is low (i. e., the stiffness is high). This quality causes some problems on removal of the impression from the mouth or

the die from the impression. More rubber between the tray and the impression area is recommended to relieve this problem. Polyethers have low tear strength values.

Manipulation. The manipulation of polyethers is similar to that of polysulfides and silicones. Equal lengths of base and catalyst paste are mixed vigorously and rapidly (30 to 45 seconds), because the working time is short. They are easy to mix. The impressions can be readily silverplated to produce accurate dies. Precautions should be taken to mix the material thoroughly and to avoid contact of the catalyst with the skin or mucosa because tissue reactions have been observed. A handheld gun-type mixer that provides quick, bubble-free mixes is available for one product (Permadyne Garant, ESPE). Also, an automatic mixing device (Pentamix, ESPE) has been introduced for use with a polyether packaged in polybags (Impregum Penta).

Advantages. Advantages of polyethers include pleasant handling and ease of mixing. These materials are more accurate than polysulfide or condensation silicone impression materials. They have good surface detail reproduction and are easily poured in stone. If kept dry, they will be dimensionally stable for up to 1 week.

Disadvantages. Disadvantages include high cost, short working and setting times and high stiffness after setting, which limit their use. Their bitter taste is objectionable to some patients. Storage of polyether impressions is critical, as they will distort if stored in water or high humidity. They cannot be left in disinfectant solutions for long periods.

Troubleshooting

1. *Inadequate working time.* This can result from excessive temperature. An increase in temperature will decrease the working and setting times. An improper base-to-catalyst ratio (too much catalyst) will decrease the working time.

2. *Tearing.* The rigidity of this material may result in tearing upon removal of the impression from the mouth or of the die from the impression. Tearing may occur if the rubber thickness is inadequate (at least 4 mm).

3. *Distortion.* The impression may distort due to moisture absorption and/or plasticizer extraction. These phenomena may result in dimensional change when impressions are stored in high-humidity environments or are exposed to water. The use of the thinner may increase the water absorption. Delay in impression placement may cause distortion. The onset of setting will result in the formation of elastic properties, which will cause deformation upon removal from the mouth.

4. *Loss of detail.* This can be caused by incomplete mixing. Failure to obtain a homogeneous mix will result in incomplete polymerization. If problems are encountered with multiple dies, it may be the result of gingival tearing and/or swelling. The rigidity and the relatively low tear strength of the polyethers may result in progressive deterioration at the gingival margin of the impression. The impression may absorb enough moisture from the gypsum that multiple pours could produce swelling.

Disinfection. Polyether impressions can be disinfected by immersion in sodium hypochlorite. The manufacturer's recommendations for proper disinfection should be followed.

In the table 5 there is a comparative characteristic of impression materials.

Table 5

Properties of impression materials

Materials		Properties			
		Precision of reflection (µm)	Deformation at compression (%)	Restoration after deformation (%)	Shrinkage in 24 hours (%)
Plaster		0	0	0	0
ZOE		50	0	0	0
Thermoplastics		0	0	0	0
Hydrocolloids		50	6,7–12,4	95	10–20
Nonaqueous elastomers	Viscosity type	0	1,3–4	96–100	0,3–0,7
		1			
		2	4,1–5		
		3			

TEST-CONTROL QUESTIONS

1. Which of these impression materials are irreversible?

- a) thermoplastic compounds;
- b) plaster;
- c) alginate hydrocolloids;
- d) nonaqueous elastomers;
- e) agar-agar hydrocolloids;
- f) zinc oxide-eugenol (ZOE).

2. What are the rigid impression materials?

- a) thermoplastic compounds;
- B) plaster;
- C) alginate hydrocolloids;
- D) nonaqueous elastomeric;
- E) agar-agar hydrocolloids;
- F) zinc-oxide-eugenol (ZOE).

3. What group do the impression materials, hardening in the result of a chemical reaction, belong to?

- a) irreversible;
- b) reversible;
- c) there is no correct answer.

4. Does the mixing time of the impression material include the working time?

- a) yes;
- b) no;
- c) depends on the production form of the impression material.

- 5. What replica of the prosthetic bed can we get with the use of impression material?**
a) negative; b) positive; c) combined.
- 6. What is the formula of the natural plaster?**
a) $\text{CaSO}_4 \cdot 2\text{H}_2\text{O}$;
b) CaSO_4 ;
c) $(\text{CaSO}_4)_2 \cdot \text{H}_2\text{O}$.
- 7. How many types of the plaster applied in dentistry are there according to the classification by ISO (The International Standard Organization)?**
a) 2; b) 3; c) 4; d) 5; e) 6; f) 7.
- 8. What is the longest time in impression taking?**
a) working time;
b) hardening time;
c) mixing time.
- 9. Which one of these modifications of calcium sulphate hemihydrate is got during thermal processing of the natural plaster in conditions of the normal atmosphere pressure?**
a) α -hemihydrate;
b) β -hemihydrate;
c) γ -hemihydrate.
- 10. What is the water/powder ratio used for the plaster type 3–5 (plaster for models α -modification) preparation?**
a) 1; b) 1,5; c) 0,18–0,3.
- 11. Name the components of ZOE impression material:**
a) zinc oxide, eugenol, gum, filler, etc.;
b) sodium alginate, calcium sulphate dihydrate, filler, etc.;
c) resin, copal resin, carnauba wax, talc, etc.
- 12. Alginate impression material is prepared by mixing:**
a) two pastes in tubes;
b) powder and water;
c) base paste and catalyst paste.
- 13. The gypsum model, casted on base of the alginate impression, should be made not later than:**
a) 15 min; b) 60 min; c) 180 min.
- 14. Which one of the listed impression materials has the largest shrinkage:**
a) gypsum;
b) alginate hydrocolloid;
c) thermoplastic compound;
d) nonaqueous elastomer.

15. Which one of the listed nonaqueous elastomers has the smallest shrinkage:

- a) silicone condensation type;
- b) polysulfide;
- c) polyether.

16. What is the restoration of nonaqueous elastomer impression materials after deformation (in % by ISO):

- a) 75;
- b) 95;
- c) 96.5–100;
- d) 5;
- e) 0.

17. What is the restoration of ZOE impression materials after deformation (in % by ISO):

- a) 75;
- b) 95;
- c) 96.5–100;
- d) 5;
- e) 0.

18. How many types of viscosity of anhydrous elastomers are there (by ISO):

- a) 1;
- b) 2;
- c) 3;
- d) 4;
- e) 5;
- f) 6.

19. What is the amount (in %) of agar-agar in reversible hydrocolloids:

- a) 79–85;
- b) 39–43;
- c) 13–17.

20. What is the name of elastic irreversible impression material, made by vulcanization of polysulfurs of a small molar mass, that have the –SH group?

- a) silicone condensation type;
- b) silicone addition type;
- c) polysulfide material;
- d) polyether material.

21. What process does cause changes in the linear sizes of hydrocolloid impression materials?

- a) imbibition;
- b) syneresis;
- c) hydrophoby.

REFERENCES

1. *Боянов, Б. К.* Ортопедична стоматология. Ч. I. Пропедевтика / Б. К. Боянов. София : Медицина и физкултура, 1957. 389 с.
2. *Гаврилов, Е. И.* Ортопедическая стоматология : учеб. / Е. И. Гаврилов, А. С. Щербаков. 3-е изд., перераб. и доп. Москва : Медицина, 1984. 576 с.
3. *Дойников, А. И.* Зуботехническое материаловедение / А. И. Дойников, В. Д. Сеницын. Москва : Медицина, 1986. 208 с.
4. *Жулев, Е. Н.* Материаловедение в ортопедической стоматологии : учеб. пособие / Е. Н. Жулев. Нижний Новгород, 1997. 136 с.
5. *Копейкин, В. Н.* Зубопротезная техника / В. Н. Копейкин, Л. М. Демнер. Москва : Медицина, 1985. 400 с.
6. *Полонейчик, Н. М.* Отгискные материалы, применяемые в стоматологии : учеб. пособие / Н. М. Полонейчик. Минск, 1998.
7. *Сидоренко, Г. И.* Зуботехническое материаловедение : учеб. пособие / Г. И. Сидоренко. Киев : Выща школа. Головное изд-во, 1988. 184 с.
8. *Braden, M.* A polyether impression rubber / M. Braden, B. Caustom, R. L. Clarke // J. Dent. Res. 1972. Vol. 51. P. 889.
9. *Braum, L.* Textbook of operative dentistry / L. Braum, R. Phillips, M. Lund. 3rd ed. Philadelphia, 1995. 662 p.
10. *Salem, N. S.* Mechanical properties of elastomeric impression materials / N. S. Salem, E. C. Combe, D. C. Watts // J. Oral Rehabil. 1988. Vol. 15. P. 125.
11. *Staegemann, G.* Einfuhrung in die Zahnheilkunde / G. Staegemann. Leipzig : J. A. Barth, 1990. 789S.
12. *Taylor, N. O.* Specification for Dental Impression Compound / N. O. Taylor, W. T. Sweeney, G. C. Paffenbarger // J.A.D. 1931. Vol. 18. P. 53–62.
13. *Voldrich, M.* Stomatologicka propedeutika / M. Voldrich. Praga : Statni zdravotnicke nakladatelstvi, 1963. 277 s.
14. *Wilson, H. J.* Impression materials / H. J. Wilson // Br. Dent. J. 1988. Vol. 164. P. 221.

CONTENTS

Introduction	3
Impression materials. General characteristic and classification	4
Properties of impression materials	6
The impression material linear size change	6
The impression material viscosity	8
The impression material hardness	8
The impression material deformation in compression	9
The impression material restoration after deformation	9
Water wettability of the impression material	10
Main periods of time used in the work with impression materials.....	11
Rigid irreversible impression materials	12
Gypsum	12
Zinc oxide-eugenol	14
Rigid reversible impression materials.....	16
Thermoplastic compounds	16
Elastic reversible impression materials.....	17
Agar-agar hydrocolloid.....	17
Elastic irreversible impression materials	20
Alginate hydrocolloid	20
Nonaqueous elastomeric impression materials.....	24
Test questions.....	34
References	37

Учебное издание

Полонейчик Николай Михайлович
Чистик Кристина Игоревна

ОТТИСКНЫЕ МАТЕРИАЛЫ

IMPRESSION MATERIALS

Учебно-методическое пособие

На английском языке

2-е издание

Ответственный за выпуск Н. М. Полонейчик
Переводчик К. И. Чистик
Компьютерная верстка Н. М. Федорцовой

Подписано в печать 21.02.18. Формат 60×84/16. Бумага писчая «Хероx office».
Ризография. Гарнитура «Times».
Усл. печ. л. 2,32. Уч.-изд. л. 2,22. Тираж 50 экз. Заказ 524.

Издатель и полиграфическое исполнение: учреждение образования
«Белорусский государственный медицинский университет».
Свидетельство о государственной регистрации издателя, изготовителя,
распространителя печатных изданий № 1/187 от 18.02.2014.
Ул. Ленинградская, 6, 220006, Минск.

Репозиторий БГМУ