

GENERAL MICROBIOLOGY

Laboratory workbook

Student name _____

Faculty _____

Group _____

Minsk BSMU 2021

ISBN 978-985-21-0719-8



9 789852 107198

МИНИСТЕРСТВО ЗДРАВООХРАНЕНИЯ РЕСПУБЛИКИ БЕЛАРУСЬ
БЕЛОРУССКИЙ ГОСУДАРСТВЕННЫЙ МЕДИЦИНСКИЙ УНИВЕРСИТЕТ
КАФЕДРА МИКРОБИОЛОГИИ, ВИРУСОЛОГИИ, ИММУНОЛОГИИ

ОБЩАЯ МИКРОБИОЛОГИЯ

GENERAL MICROBIOLOGY

Лабораторный практикум

3-е издание



Минск БГМУ 2021

УДК 576.8(076.5)(075.8)-054.6
ББК 52.64я73
О-28

Рекомендовано Научно-методическим советом университета в качестве
лабораторного практикума 23.12.2020 г., протокол № 14

Авторы: доц. В. В. Слизень; доц. Е. Ю. Кирильчик; доц. Ж. Г. Шабан; доц.
Д. А. Черношей; доц. Т. А. Канашкова

Рецензенты: канд. мед. наук, доц. В. Э. Бутвиловский; канд. мед. наук, доц.
А. М. Близнюк

Общая микробиология = General microbiology : лабораторный практикум / В. В. Слизень [и др.]. – 3-е изд. – Минск : БГМУ, 2021. – 79 с.

ISBN 978-985-21-0719-8.

Содержит информацию для подготовки к практическим занятиям по разделу «Общая микробиология». Приведены схемы, алгоритмы, справочные сведения, методики выполнения лабораторных работ. Первое издание вышло в 2019 году.

Предназначен для студентов 2-го курса медицинского факультета иностранных учащихся, обучающихся на английском языке.

УДК 576.8(076.5)(075.8)-054.6
ББК 52.64я73

ISBN 978-985-21-0719-8

© УО «Белорусский государственный
медицинский университет», 2021

CONTENT

| | |
|--|----|
| Practical class № 1. Methods in diagnostic microbiology. Microscopic method of examination. Basic morphological forms of bacteria. Simple methods of staining | 4 |
| Practical class № 2. Microscopic method of examination. The morphology and fine structure of bacteria. Differential methods of staining | 14 |
| Practical class № 3. The topic: Microscopic method of examination. The morphology and fine structure of bacteria. Differential methods of staining..... | 25 |
| Practical class № 4. Microscopic method of examination. The morphology of the spirochetes, actinomyces, rickettsiae, chlamydiae, mycoplasmas..... | 31 |
| Practical class № 5. Antimicrobial measures. Methods of sterilization and disinfection. Asepsis and antisepsis. Bacteriological method of laboratory diagnosis of infection diseases. Techniques of microbial pure cultures isolation and maintenance | 35 |
| Practical class № 6. Bacteriological method of laboratory diagnosis of infection diseases. Techniques for pure culture identification | 50 |
| Practical class № 7. Molecular Basis of Bacterial Genetics. Molecular methods of infection diseases diagnosis and bacterial genetic investigations..... | 56 |
| Practical class № 8. Ecology of microorganisms. Methods of human normal flora investigation. Infections | 61 |
| Practical class № 9. Antibiotic susceptibility testing of microorganisms. Application of laboratory animals in microbiology. | 65 |
| Practical class № 10. Credit 1 “Morphology and physiology of microorganisms. Infection”..... | 76 |

Practical class № 1

METHODS IN DIAGNOSTIC MICROBIOLOGY. MICROSCOPIC METHOD OF EXAMINATION. BASIC MORPHOLOGICAL FORMS OF BACTERIA. SIMPLE METHODS OF STAINING

Suggested reading for self-study. History of the department microbiology, virology, immunology; main spheres of activity and trends in research. Design and equipment of microbiological laboratory, biosafety levels. Basic rules of work in microbiological laboratory (biosafety in work with class II biohazards). Universal precautions in work with burners and electric supplies.

Taxonomy of microorganisms: classification and nomenclature. Modern approaches to taxonomy of microorganisms. Taxonomic ranks. Vars (types), strains, clones, pure cultures.

Basic morphological forms of bacteria. Morphological characteristics of cocci, rods and spiral-shaped bacteria.

Microscopic method of examination: tasks, procedure, evaluation of the method. Bright-field light microscope: components and proper use of the microscope. Smear preparation and fixation. Simple methods of staining. The technique of oil immersion microscopy.

UNIVERSAL PRECAUTIONS AND LABORATORY SAFETY PROCEDURES

General regulations

1. Restrict or limit access to the laboratory when working.
2. Eating, drinking and smoking are forbidden at all times in the laboratory.
3. Use protective clothing (lab coat) obligatory during all work activities to protect clothing from contamination or accidental discoloration by staining solutions.
4. If necessary use personal protective equipment (gloves, face protection, eye protection).
5. Do not place anything in your mouth while in the laboratory. This includes pencils, food, and fingers. Learn to keep your hands away from your mouth and eyes.
6. Place all extra clothing, unnecessary books, purses, backpacks in an appropriate place. The laboratory work area must be kept free from unnecessary things.
7. Decontaminate work surfaces daily.
8. Maintain insect and rodent control program.

Precautions during work

1. Work according to plan and fill in all the required reports in laboratory manual and have them signed by the tutor.
2. Mechanical pipetting devices should be used for manipulating all liquids in the laboratory. Mouth pipetting must not be done.
3. Flame wire loops and needles before and immediately after transfer of cultures. Do not move through the laboratory with a loop or pipette containing infectious material.
4. Be careful with the burner flame.
5. Use of needles and syringes should be limited to situations in which there is no alternative, and the recommendations for preventing injuries with needles should be followed.
6. Minimize splashes and aerosols during laboratory procedures.
7. Avoid contamination of benches, floor, and wastebaskets during experiment.
8. Blood and other body fluids from all patients should be considered infective. All persons processing blood and body-fluid specimens should wear gloves. Gloves should be changed and hands washed after completion of specimen processing.
9. Slides and coverslips are glass. Do not cut yourself when using them. Dispose of any broken glass in the appropriately labeled container.

Precautions after work

1. Label all experimental material with: a) your name; b) date; c) specimen; d) microorganism name.
2. Return all reagents, cultures, and glassware to their appropriate places after experiment.

3. Contaminated materials used in laboratory tests should be decontaminated before reprocessing. Special receptacles will be provided for infectious materials and used glass slides. Place all discarded cultures and contaminated glassware into these receptacles. Tall jars filled with a germicide will be provided for pipettes.

4. After completing laboratory activities wash your hands thoroughly, using disinfecting soap and remove your protective clothes.

Precautions after accidents

1. Laboratory work surfaces should be decontaminated with an appropriate chemical germicide after a spill of blood, other body fluids, microbial cultures

2. The following procedure should be used to clean up spills of blood or blood-containing fluids:

i. put on gloves and any other necessary barriers.

ii. wipe up excess material with disposable towels and place the towels in a container for sterilization.

iii. disinfect the area with either a commercial germicide or household bleach (sodium hypochlorite).

3. When infectious material is accidentally spilled, cover it immediately with a disinfectant and notify your instructor at once.

4. When infectious material is accidentally spilled on skin, wash it with antiseptic first and then with soap thoroughly and notify your instructor at once.

Biosafety — combinations of laboratory procedures, laboratory facilities and safety equipment that protect workers, “products”, co-workers, lab support personnel, environment when working with potentially infectious microorganisms (Table 1.1).

A **biosafety level (BSL)** is the level of the biocontainment precautions required to isolate dangerous biological agents in an enclosed facility. As of 2006, there are four safety levels. Higher numbers indicate a greater risk to the external environment.

A **biological hazard** or **biohazard** is an organism, or substance derived from an organism, that poses a threat to human health. This can include medical waste or samples of a microorganism, virus or toxin (from a biological source) that can impact human health. It can also include substances harmful to animals.

Table 1.1

Biosafety levels

| Biosafety level | Explanation | Lab requirements | Organisms |
|---|---|--|---|
| BSL1 (the lowest level of biosafety) | Biological agents that pose low risk to personnel and the environment, well-characterized | No special requirements: sink for hand washing, work surfaces easily cleaned, sturdy furniture, windows fitted with flyscreens, no automatic ventilation, personal protective clothing (gloves, gowns), pipetting devices, eye and face protection, autoclave, safety centrifuge cups and rotors | <i>Agrobacterium radiobacter</i> , <i>Aspergillus niger</i> , <i>Bacillus thuringiensis</i> , <i>Escherichia coli</i> K12 <i>Lactobacillus acidophilus</i> , <i>Micrococcus leuteus</i> , <i>Pseudomonas fluorescens</i> , <i>Serratia marcescens</i> |
| BSL2 | Biological agents that pose moderate risk to personnel and the environment, rarely cause serious disease. Effective treatment and preventive measures are available in the event that an infection occurs | Biological safety cabinets class 1, extreme precautions are taken with contaminated sharp items and certain procedures in which infectious aerosols or splashes may be created | <i>Mycobacterium other than tuberculosis</i> , <i>Streptococcus pneumonia</i> , <i>Clostridium difficile hepatitis A</i> , <i>B</i> , <i>C</i> , <i>influenza A</i> , <i>Lyme disease</i> , <i>Salmonella</i> , <i>Mumps</i> , <i>Bacillus subtilis</i> <i>Measles</i> , <i>HIV</i> , <i>scrapie</i> , <i>MRSA</i> and <i>VRSA</i> , genetically modified organisms |

| Biosafety level | Explanation | Lab requirements | Organisms |
|-----------------|--|--|---|
| BSL 3 | Biological agents that may cause serious or potentially lethal diseases as a result of exposure by inhalation but for which vaccines or other treatments exist | Biological safety cabinets class 2 | <i>Mycobacterium tuberculosis</i> , <i>Bacillus anthracis</i> , <i>West Nile virus</i> , <i>Venezuelan equine encephalitis virus</i> , <i>SARS virus</i> , <i>smallpox</i> , <i>Rift Valley fever virus</i> , <i>Rocky Mountain spotted fever</i> , <i>Plasmodium falciparum</i> , <i>Trypanosoma cruzi</i> , <i>Salmonella typhi</i> , <i>Coxiella burnetii</i> , <i>Rickettsia rickettsii</i> , <i>Yellow fever virus</i> |
| BSL 4 | Dangerous/exotic agents that pose high risk of life-threatening disease, and for which vaccines or other treatments are not available | Biological safety cabinets class 3 or "space suit" with a self-contained oxygen supply | <i>Bolivian and argentine hemorrhagic fevers</i> , <i>H5N1(bird flu)</i> , <i>Dengue hemorrhagic fever</i> , <i>Marburg virus</i> , <i>Ebola virus</i> , <i>Hantaviruses</i> , <i>Lassa fever</i> , <i>Crimean-Congo hemorrhagic fever</i> , <i>Y. pestis</i> , <i>other hemorrhagic diseases</i> |

Microbiology. Microbiology deals with **microscopic** organisms, the smallest, simplest single-celled organisms unseen without magnification. **Bacteria, viruses, fungi, protozoa, algae** and **helminths** are the major biological groups that microbiologists study. Microbiology also studies the natural history of microbes, aspect of microbe-human and microbe-environmental interactions. Microorganisms have a tremendous impact on all life and the physical and chemical make-up of our planet. They are responsible for cycling the chemical elements essential for life, including carbon, nitrogen, sulfur, hydrogen, and oxygen; more photosynthesis is carried out by microorganisms than by green plants. It has been estimated that 5×10^{30} microbial cells exist on earth; excluding cellulose, these cells constitute about 90 % of the biomass of the entire biosphere. Humans also have an intimate relationship with microorganisms; more than 90 % of the cells in our bodies are microbes. Microbiology is divided into fundamental and applied microbiology.

The subordinate **branches of fundamental microbiology are:** bacteriology, mycology, protozoology, virology, parasitology, phycology or algology, microbial morphology, microbial physiology, microbial taxonomy, microbial genetics and molecular biology, microbial ecology.

The subordinate **branches of applied microbiology are:**

a) **public health microbiology** and **epidemiology** aim to monitor and control the spread of diseases in communities. Centers for Disease Control and Prevention (CDC located in Atlanta, USA), and the World Health Organization (WHO) collects information on diseases and publishes it in a weekly newsletter called the *Morbidity and Mortality Weekly Report*;

b) **food microbiology, dairy microbiology** and **aquatic microbiology**;

c) **agricultural microbiology**;

d) **biotechnology**;

e) **industrial microbiology**;

f) **genetic engineering and recombinant DNA technology.** Involve techniques that alter the genetic makeup of organisms to develop organisms with unique and useful properties.

g) **pharmaceutical microbiology.**

Taxonomy of microorganisms: classification and nomenclature. Modern approaches to taxonomy of microorganisms. Taxonomic groups. Vars (types), strains, clones, pure cultures.

Taxonomy. Includes classification, nomenclature, and identification of microorganisms. Purpose of taxonomy is to provide useful ways for identifying and comparing organisms. The bacteria are classified in a hierarchic system based on phenotypic, genome characteristics and chemical

composition. Bacteria are grouped in the domain bacteria to separate them from the domains archaea and eucarya. Within their domain, bacteria are further broken down into taxonomic groups (taxa) based on relationships best elucidated by knowledge of the evolutionary facts. However, little is known about the phylogenetic relationships of bacteria, so their classification is often based on similarities among phenotypic characteristics (phenetic relationships). Taxonomic groups of the prokaryotes are phyla, classes, orders, families, genera, and species, plus subtaxa (vars, strains) if any. The basic unit is the species.

Nomenclature. A species is designated by two Latin names, the first of which denotes the genus, both together characterizing the species. The rules of bacterial nomenclature are set out in the International Code for the Nomenclature of Bacteria. Taxonomic names are approved by the International Committee of Systematic Bacteriology. Family names always end in -aceae.

Strain — a set of descendants cloned from a common ancestor that retain the original characteristics. Any deviation from the original is a different strain.

Clone — a colony of cells (or group of organisms) derived from a single cell (or single organism) by asexual reproduction. All units share identical characteristics.

Vars (syn. types) — microorganisms belonging to the same specie but displaying minor variability in virulence, antigens, morphology, in susceptibility to phages, antibiotics, etc. Examples: biovar, phagovar, pathovar, morphovar, serovar.

Pure culture — the visible accumulation of identical microorganisms of the same specie in or on a nutrient medium.

There is no official, internationally recognized classification of bacteria. Most systems of classifications are in a state of flux as new information and methods of analysis become available. Existing classifications of microorganisms: 1) classification from the ninth edition of *Bergey's Manual of Systematic Bacteriology*, published continuously since 1923; 2) classification by rRNA genes sequence discrepancies; 3) classification of medically important bacterial families by a few morphological and physiological traits.

The ninth edition of *D g t i g { ø u " O c p w c n*. It organizes the Kingdom Procaryotae into four major divisions basing upon the nature of the cell wall. The **Gracilicutes** have gram-negative cell walls and thus are thin-skinned; the **Firmicutes** have gram-positive cell walls that are thick and strong; the **Tenericutes** lack a cell wall and thus are soft; and the **Mendosicutes** are the archaea (also called archaebacteria), primitive procaryotes with unusual cell walls and nutritional habits. The first two divisions contain the greatest number of species. The 200 or so species that cause human and animal diseases can be found in four classes: the Scotobacteria, Firmibacteria, Thallobacteria, and Mollicutes. The system used in *Bergey's Manual* further organizes bacteria into subcategories such as classes, orders, and families.

Major Taxonomic Groups of Bacteria per *D g t i g { ø u " O c p w c n*

Division I. Gracilicutes: Gram-Negative Bacteria

Class I. Scotobacteria: Gram-negative non-photosynthetic bacteria

Class II. Anoxyphotobacteria: Gram-negative photosynthetic bacteria that do not produce oxygen (purple and green bacteria)

Class III. Oxyphotobacteria: Gram-negative photosynthetic bacteria that evolve oxygen (cyanobacteria)

Division II. Firmicutes: Gram-Positive Bacteria

Class I. Firmibacteria: Gram-positive rods or cocci

Class II. Thallobacteria: Gram-positive branching cells (the actinomycetes)

Division III. Tenericutes

Class I. Mollicutes: Bacteria lacking a cell wall (the mycoplasmas)

Division IV. Mendosicutes

Class I. Archaebacteria: Bacteria with atypical compounds in the cell wall and membranes

Classification by rRNA genes sequence discrepancies. It is an approach allowing to create natural classification of microorganisms reflecting their phylogenetic relationships. According to rRNA genes analyzing bacterial phylogenetic “tree” include 11 distinct branches (groups):

1. Gram-positive eubacteria: Selected representatives are *Bacillus*, *Clostridium*, *Mycobacterium*, *Staphylococcus*, *Actinomyces* and the cell-wall-free mycoplasmas.
2. Gram-negative eubacteria (Proteobacteria) includes purple photosynthetic bacteria (*Chromatium*) and nonphotosynthetic relatives represented by *Pseudomonas*, *Vibrio*, *Neisseria* and the rickettsias.
3. Cyanobacteria: photosynthetic bacteria with chlorophyll *a* that evolve (give off) oxygen; includes *Oscillatoria* and *Spirulina*.
4. Spirochetes: flexible helical cells with periplasmic flagella such as *Treponema* and *Borrelia*.
5. Walled, budding bacteria that lack peptidoglycan in their cell walls: includes *Planctomyces*.
6. The *Bacteroides*, *Flavobacterium*, *Fusobacterium* and *Cytophaga*: a mixed group morphologically and physiologically.
7. Chlamydias: unusual obligate parasites of vertebrates; lack ability to complete metabolism independently; lack peptidoglycan; one genus — *Chlamydia*.
8. Green sulfur bacteria: anaerobic bacteria that contain bacteriochlorophyll and use sulfur in metabolism; do not give off oxygen during photosynthesis; includes *Chlorobium*.
9. Green nonsulfur bacteria: filamentous, gliding, thermophilic, photosynthetic bacteria that contain bacteriochlorophyll, do not evolve oxygen; includes *Chloroflexus*.
10. Unique bacteria with extreme resistance to electromagnetic radiation: *Deinococcus*, gram-positive cocci and *Thermus*, thermophilic rods.
11. Unusual thermophilic bacteria inhabiting hot oceanic vents: *Thermotoga*.

Basic morphological forms of bacteria. Morphological characteristics of cocci, rods and spiral-shaped bacteria.

Three basic forms (based on the shape of a single cell) are observed in bacteria: spherical, straight rods, and spiral-shaped microorganisms (Fig. 1.1).

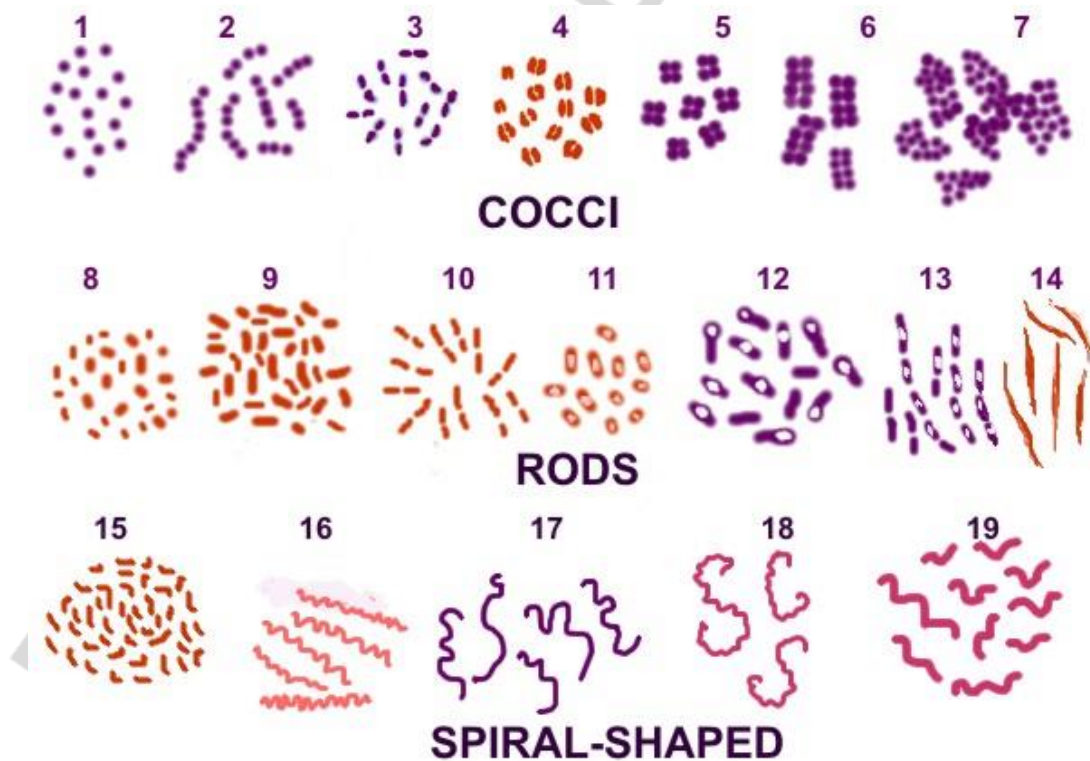

Figure 1.1. Three basic forms of bacteria

Fill in the numbers in the table according to the picture above:

| COCCI | | STRAIT RODS | | SPIRAL-SHAPED BACTERIA | |
|-------|----------------|-------------|----------------------------|------------------------|-------------------------|
| | micrococcus | | coccobacterium | | vibrio |
| | diplococcus | | bacterium | | spirochete (treponema) |
| | tetrad | | diplobacterium | | spirochete (borrelia) |
| | sarcinae | | bipolar-staining bacterium | | spirochete (leptospira) |
| | streptococcus | | clostridium | | spirillum |
| | staphylococcus | | streptobacillus | | |
| | | | fusobacterium | | |

Spirilla versus Spirochetes.

Spirilla. Their cells represent gram-negative rigid helix with number of helical turns from 1 to 20. Spirilla have from 1 to several polar flagella that make it possible to swim by rotating around like corkscrews. During locomotion they do not flex. Most are harmless saprobes; one species, *Spirillum minor*, causes rat bite fever.

Spirochetes. Their cells represent gram-negative flexible helix with the number of helical turns from 3 to 70. Spirochetes have 2–100 periplasmic flagella allowing them to swim by rotation or by creeping on surfaces. During locomotion they can flex. *Treponema pallidum* is a causative agent of syphilis; *borrelia* and *leptospira* are medically important pathogens.

Microscopic method of examination: tasks, procedure, evaluation of the method.

Microscopic method of examination — the use of *microscope* for examining objects or details which are too small to be seen by the unaided eye in order to investigate morphology of microorganisms in biological specimens or pure cultures. The leading aim of the method: etiologic diagnosis of a disease and control of pure culture isolation.

Steps of the method: 1) specimen collection; 2) transportation to the laboratory, keeping and preliminary specimen preparation; 3) preparation of the slide; 4) microscopy of the slide; 5) analysis of the results and report.

Specimen collection. Specimen collection is an important step in laboratory diagnosis of infection diseases. Material from which the pathogen is to be isolated should be sampled aseptically as early as possible before chemotherapy. If a specimen is not inappropriately chosen and/or collected specimen can be the reason for failure to establish an etiologic diagnosis. There are three specimen categories:

Direct Tissue or Fluid Samples. Direct specimens are collected from normally sterile tissues (lung, liver) and body fluids (cerebrospinal fluid, blood) by special surgical manipulation (needle aspiration, surgical biopsy). Positive findings are diagnostic and negative findings can exclude infection at the suspected site.

Indirect Samples. Indirect samples are specimens of inflammatory exudates (expectorated sputum, voided urine) that have passed through sites known to be colonized with normal flora. The site of origin is usually sterile in healthy persons; however, some assessment of the probability of contamination with normal flora during collection is necessary before these specimens can be reliably interpreted.

Samples from Normal Flora Sites. Frequently the primary site of infection is in an area known to be colonized with many organisms (pharynx and intestine). In such instances, examinations are selectively made for organisms known to cause infection that are not normally found at the infected site. For example, *Salmonella*, *Shigella* and *Campylobacter* are obligate pathogens of intestine.

Examples of specimens:

material from the respiratory tract: swab smear from tonsils; sinus flushing fluid, expectorated sputum, bronchoscopically sampled bronchial secretion, flushing fluid from bronchoalveolar lavage (BAL), transtracheal aspirate or a pulmonary puncture biopsy;

material from the urogenital tract: voided urine, urine taken by a suprapubic bladder puncture, genital secretions sampled with smear swabs;

blood: 5–10 ml of venous blood;

discharge from wounds: pus, fluid exudates sampled with smear swabs or syringe;

material from the gastrointestinal tract: stool specimens, biopsy, gastric or duodenal juice, bile;

other specimens: cerebrospinal fluid, milk, puncture biopsies, exudates, transudates, food, environmental specimens.

2. Transportation to the laboratory, keeping and preliminary preparation of the specimens. Transport to the laboratory must be carried out in special containers provided by the institutes involved. Special containers or transport media should be used if anaerobes are suspected. An invoice must be attached to the material containing the information required for processing (using the form provided).

3. Preparation of the required slide. Different microscopic preparations can be done to investigate specimens under microscope: hanging drop; fin smear, fixed smear, wet mount.

4. Microscopy of the slide. Prepared **slide** is investigated under one of the light microscopes: 1) bright-field; 2) dark-field; 3) phase-contrast; 4) fluorescence.

5. Analysis and final report. Microscopic examination of a smear allows determining: a) shape, size, grouping of microorganisms, b) amount of microorganisms in the smear; e) staining. Under microscope etiologic diagnosis can be determined for limited numbers of diseases in case the causative agent has unique morphological properties. Examples of the diseases that can be diagnosed by direct microscopy of biological specimens: a) meningococcal meningitis; b) tuberculosis; c) pneumococcal meningitis and pneumonia; d) gonorrhoea; e) chlamydiosis; f) syphilis etc.

Evaluation of the method. Simple, cheap, fast, widely used. It is characterized by: 1) low sensitivity — bacteria can only be discerned in a preparation in which their density is at least 10^4 – 10^5 bacteria per ml; 2) low specificity — because of identical morphology many microorganisms can not be identified under microscope.

Bright-field light microscope: components and proper use of the microscope. Bacteria are so small that their size is most conveniently expressed in *micrometers*. A micrometer is a thousandth part of a millimeter. Bacteria vary in length and diameter, the smallest being about 0.5 to 1 μm long and approximately 0.5 μm in diameter, whereas the largest filamentous forms may be as long as 100 μm . That is why microbiologists employ a variety of light microscopes in their work: 1) bright-field; 2) dark-field; 3) phase-contrast; 4) fluorescence. *Bright-field microscopy* is the commonest form of light microscopy. The **bright-field light microscope** is an instrument that magnifies images using two lens systems. Essentially, light from a lamp is concentrated by the CONDENSER and directed onto the specimen. The objective lens (“objective”) forms a magnified image of the specimen, and this image is further magnified by the eyepiece lens. The specimen is usually examined on a SLIDE which rests on the stage. Most microscopes have at least three objective lenses on a rotating base. The objective lenses are identified as the **low-power, high-dry** and **oil immersion objectives**.

Proper use of the microscope:

1. Always carry the microscope with two hands. Place it on the desk with the open part away from you.

2. Clean all of the microscope’s lenses only with lens paper and lens cleaner if necessary. Do not use paper towels that can scratch the lenses. **Do not remove the oculars or any other parts from the body of the microscope.**

3. Place the smear on the stage of the microscope and secure it firmly using stage clips.

4. While looking at the microscope from the side lower the tube until the tip of the objective is within 5 mm of the slide. It should be deep in the immersion oil.

5. Look into the microscope and slowly raise the tube by turning the coarse adjustment knob counterclockwise until the object comes into view. Once the object is in view, use the fine adjustment knob to focus the desired image. If a slide is inadvertently placed upside down on the microscope stage, you will find it impossible to bring the object into focus.

6. Usually the microscope is used with the substage condenser in its topmost position. The diaphragm should be open and then closed down until just a slight increase in contrast is observed.

7. After work with microscope, clean the oil from the oil immersion lens with lens paper and lens cleaner, cover, and return the microscope to its proper storage place.

The Oil Immersion Objective. An oil immersion objective lens operating in air and with immersion oil. Light rays that must pass through air are bent (refracted), and many do not enter the objective lens. The immersion oil prevents the loss of light rays (Fig. 1.2).

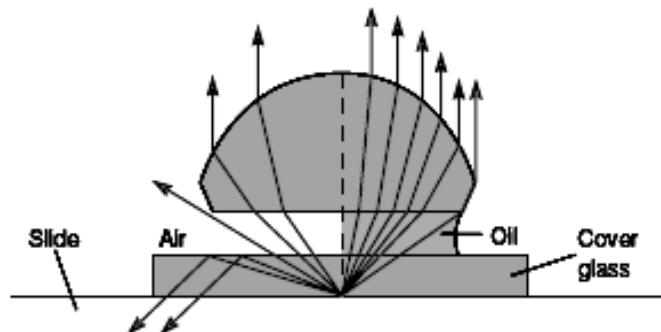

Figure 1.2. The immersion oil prevents the loss of light rays

Smear preparation and fixation.

The tasks of smear preparation and fixation are: 1) preparation of biofilm with correct density of bacteria (if too many bacteria are taken they overlap each other; if too few, they cannot be located on the slide); 2) killing of the bacteria; 3) fixation of biofilm on the surface of the slide.

Requirements: grease-free slide, water resistant marker, sterile distilled water (or isotonic solution), bacteriological loop, source of flame, microbial culture (in broth or on agar media).

Procedure:

Mark a circle on the underside of a slide with a water resistant marker.

Place a small drop of distilled water on the slide over the circled area (if the smear prepared from agar medium culture). In case a smear is prepared from broth culture a drop of broth culture should be placed directly on the slide (without drop of distilled water)

Take aseptically material from a culture and mix thoroughly with the drop of distilled water. Air-dry the drop with suspension of microorganisms.

While holding the slide pass it quickly through a flame. Three quick passes are usually sufficient to kill the bacteria and cause them to adhere.

After cooling the slide, stain fixed smear.

Simple methods of staining.

Microscopic examination of microorganisms requires preparation of one of the following slides:

native preparations, with or without vital staining, are used to observe living bacteria. The poor contrast of such preparations makes it necessary to amplify this aspect using dark field or phase contrast microscopy;

stained preparations. Staining is commonly used to facilitate detection or observation of specific organisms or intracellular features. The staining procedure kills the bacteria. The material is first applied to a slide in a thin layer, dried in the air, and fixed with heat or methyl alcohol. Simple and differential staining techniques are used.

Simple methods of staining require only a single dye and an uncomplicated procedure, **differential stains** use two different-colored dyes, called the *primary dye* and the *counterstain*, to distinguish between cell types or parts. These staining techniques tend to be more complex and sometimes require additional chemical reagents to produce the desired reaction. Simple stains cause all cells in a smear to appear more or less the same color, regardless of type, but they reveal such bacterial characteristics as shape, size, and grouping. The best bacterial stains are *aniline dyes* (synthetic organic dyes made from coal-tar products). When they are used directly on fixed bacterial smears, the contours of bacterial bodies are clearly seen. These dyes react in either an *acidic*, *basic*, or *neutral* manner. Acidic or basic stains are used primarily in bacteriologic work. The free ions of *acidic* dyes are anions (negatively charged) that combine with cations of a base in the stained cell to form a salt. *Basic* dyes possess cations (positively charged) that combine with an acid in the stained material to form a salt. Bacterial cells are rich in ribonucleic acid and therefore stain very well with basic dyes. *Neutral* stains are made by combining acidic and basic dyes. They are most useful for staining complex cells of higher forms because they permit differentiation of interior structures, some of which are basic, some acidic. Stained bacteria can be measured for size and are classified by their shapes and groupings. Widely used dyes for simple staining techniques are malachite green, crystal violet, basic fuchsin, safranin. The best-known simple staining technique employs methylene blue.

The technique of simple staining:

- prepare fixed smear;
- place a slide with a bacterial smear on a staining rack;
- cover the smear completely with a few drops of a solution of methylene blue (or fuchsin, or crystal violet) and stain for 3 minute;
- pour off the stain and rinse the smear with water.

Gently blot dry (do not rub) with clean absorbing paper to remove excess water. Be careful not to rub the smear when drying the slide because this will remove the stained bacteria.

examine all slides with 100× immersion microscope objective.

Place for notes:

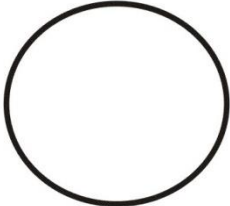
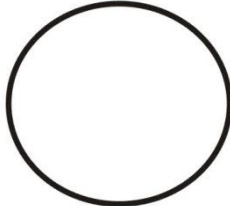
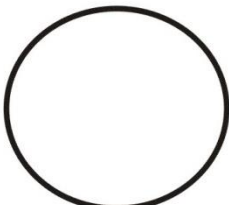
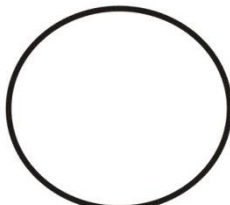
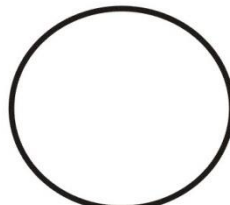
| Laboratory exercises | Laboratory report |
|---|--|
| 1. Prepare heat-fixed slide of <i>Escherichia coli</i> , cultured on agar medium, stain with methylene blue, examine under the oil immersion lens and complete the report | <div style="display: flex; justify-content: space-around; align-items: center;"> <div style="text-align: center;">  Smear _____ Stain _____ </div> <div style="text-align: center;">  Smear _____ Stain _____ </div> </div> |
| 2. Prepare heat-fixed slides of <i>Staphylococcus spp.</i> , cultured on liquid medium, stain with basic fuchsin, examine under the oil immersion lens and complete the report | <div style="display: flex; justify-content: space-around; align-items: center;"> <div style="text-align: center;">  Smear _____ Stain _____ </div> <div style="text-align: center;">  Smear _____ Stain _____ </div> <div style="text-align: center;">  Smear _____ Stain _____ </div> </div> |
| 3. Complete the drawings of slides seen in demonstration room: a. <i>Streptococcus spp.</i> , pure culture, stained with crystal violet b. <i>Vibrio spp.</i> , pure culture, stained with basic fuchsin c. <i>Bacillus spp.</i> , pure culture, stained with crystal violet | <p>Report: Simple methods of staining allow determining of</p> <p>_____</p> <p>_____</p> <p>_____</p> |
| | <p style="text-align: center;">Signature of the tutor _____</p> |

Questions for self-control and discussion:

1. What are the two purposes of heat fixation?
2. What is the purpose of simple staining?
3. Why are basic dyes more successful in staining bacteria than acidic dyes?
4. Name three basic stains.
5. Why is time an important factor in simple staining?
6. How would you define a properly prepared bacterial smear?
7. Why should you use an inoculating needle when making smears from solid media? An inoculating loop from liquid media?
8. Why is oil necessary when using the 90× to 100× objective?
9. What are three bacterial shapes you observed?
10. How can you increase the resolution on your microscope?
11. In microbiology, what is the most commonly used objective? Explain your answer.

Practical class № 2

MICROSCOPIC METHOD OF EXAMINATION. THE MORPHOLOGY AND FINE STRUCTURE OF BACTERIA. DIFFERENTIAL METHODS OF STAINING

Suggested reading for self-study. Distinctive features of prokaryotic and eukaryotic cells. Basic bacterial cell structure: components of bacterial cell. The composition, function, detection methods of bacterial cell wall. The structure of murein (syn. peptidoglycan). The cell wall of gram-positive bacteria. The cell wall of gram-negative bacteria. Gram stain: medical application, principles, procedure for Gram stain. Bacterial forms with defective cell wall (protoplasts, spheroplasts and L forms): factors inducing cell wall removal, medical importance of L-forms.

The composition, function of capsule, flagella, pili (fimbriae) and methods for their detection. Detection of capsule using negative staining.

Distinctive features of prokaryotic and eukaryotic cells.

Distinctive features of prokaryotic and eukaryotic cells are listed in Table 2.1.

Table 2.1

Characteristics of prokaryotic and eukaryotic microorganisms

| Characteristic | Prokaryotes | Eukaryotes |
|-----------------------------------|--|--|
| Nuclear structure | Circular DNA molecule not covered with proteins | Complex of DNA and basic proteins |
| Localization of nuclear structure | Dense tangle of DNA in cytoplasm; no nuclear membrane; nucleoid or nuclear equivalent | In nucleus surrounded by nuclear membrane |
| Extrachromosomal DNA | Often present in form of plasmids | In organelles (mitochondria) |
| Cytoplasm | No mitochondria, no endoplasmic reticulum, no lysosomes | Mitochondria and endoplasmic reticulum |
| Ribosomes | 70S, in cytoplasm | 80S, in cytoplasmic reticulum |
| Cell wall | Usually rigid wall with murein layer; exception: mycoplasmas | Present only in fungi: glucans, mannans, chitin, chitosan, cellulose |
| Cytoplasmic membrane | Contains enzymes of respiration; active secretion of enzymes; site of phospholipid and DNA synthesis | Semipermeable layer not possessing functions of prokaryotic membrane |
| Sterols in cytoplasmic membrane | Absent (except in <i>Mycoplasma</i>) | Usually present |
| Reproduction | Asexual, by binary transverse fission | In most cases sexual, possibly asexual |

Basic bacterial cell structure: components of bacterial cell.

Basic bacterial cell structure are listed in Table 2.2 and showed in Fig. 2.1.

Table 2.2

Components of bacterial cell

| Prokaryotic cell | | |
|---|---|--|
| Appendages | Cell envelope | Cytoplasm |
| Flagella/periplasmic flagella Pili Fimbriae | Glycocalyx (capsules, slime layers) Cell wall Cell membrane | Nucleoid Ribosomes Mesosomes Granules Plasmids |

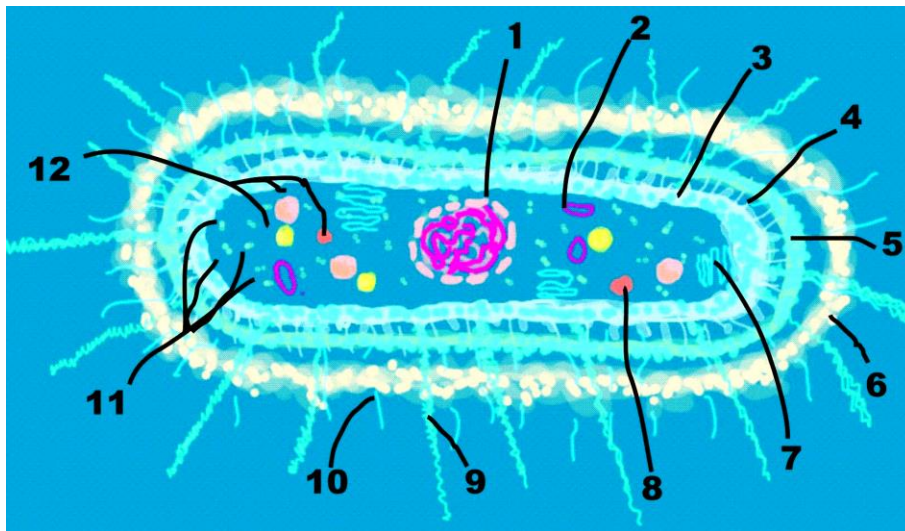

Figure 2.1. Basic fine structure of bacteria

Fill in the table with appropriate numbers according to picture.

Table 2.3

| | | | |
|--|-------------------|--|--|
| | the nucleoid | | the periplasmic space |
| | plasmids | | capsule |
| | the cell membrane | | flagella |
| | the cell wall | | pili (fimbriae) |
| | outer membrane | | mesosomes |
| | ribosome | | inclusions (poly-hydroxybutyric acid, glycogen, sulfur, polyphosphate) |

The composition, function, detection methods of bacterial cell wall. The structure of murein (syn. peptidoglycan).

Cell wall — a rigid layer above cytoplasmic membrane encountering in all eubacterial cells except wall-less bacteria such as the mollicutes (mycoplasmas) and *Chlamydia*.

The functions of the bacterial wall are:

1. To protect the protoplasts from mechanical disruption and maintain the osmotic pressure gradient between the cell interior and the extracellular environment.
2. To give the cell its outer shape.
3. To facilitate communication with surroundings — contain receptors and other molecules of signalling pathways.
4. To protect a minute, fragile cell from chemical, physical, biological assault while still permitting the rapid exchange of nutrients and metabolic byproducts required by rapid growth.
5. To protect from phagocytosis in several species of pathogenic microorganisms.
6. To participate in the binding to eukaryotic cell hosts.
7. Antigen properties.

The most important structural element of the wall is a unique macromolecule murein (syn. peptidoglycan) — a netlike polymer material made up of polysaccharide chains crosslinked by peptides, which is found nowhere except in prokaryotes.

Murein consists of a linear glycan chain of two alternating sugars, *N*-acetylglucosamine (NAG) and *N*-acetylmuramic acid (NAM) (Fig. 2.2). Each muramic acid residue bears a tetrapeptide consisting of L- and D-amino acids. Adjacent glycan chains are cross-linked by peptide bonds between the third amino acid of one tetrapeptide and the terminal D-alanine of another. The same cross-links between other tetrapeptides connect the sheets to form a three-dimensional, rigid matrix. The cross-links may be direct or may include a peptide bridge, as, for example, a pentaglycine

bridge in *Staphylococcus aureus*. Murein is much the same in all bacteria, except that there is diversity in the nature and frequency of the cross-linking bridge and in the nature of the amino acids at positions 2 and 3 of the tetrapeptide. The unique properties of cell wall are supported by components not widely distributed in the biological world: muramic acid, D-amino acids, and diaminopimelic acid (an amino acid found in the tetrapeptide of some species).

Most enzymes found in mammalian hosts and other biological systems do not degrade peptidoglycan; one important exception is lysozyme, the hydrolase present in tears and other secretions, which cleaves the glycosidic bond between muramic acid and glucosamine residues, thereby disrupting integrity of peptidoglycan. Some disinfectants (alcohol, detergents) also kill bacterial cells by damaging the cell wall. Beta-lactam antibiotics (penicillin, cephalosporins) target the synthesis of peptidoglycan and display bactericide effect on bacteria.

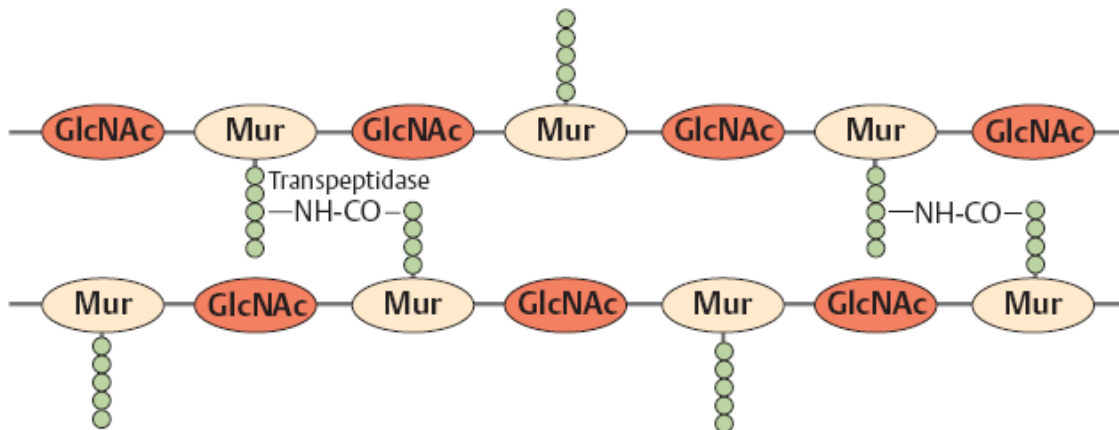

Figure 2.2. The structure of murein

The cell wall of gram-positive bacteria.

The Gram-positive cell wall contains two major components, peptidoglycan and teichoic acids, plus additional carbohydrates and proteins, depending on the species (Table 2.4, Fig. 2.3).

The murein sacculus of gram-positive bacteria may consist of as many as 40 layers (15–80 nm thick).

Most gram-positive cell walls contain considerable amounts of **teichoic** and **teichuronic acids**, which may account for up to 50 % of the dry weight of the wall and 10 % of the dry weight of the total cell.

Teichoic acids are polymers of either glycerol phosphate or ribitol phosphate, with various sugars, amino sugars, and amino acids as substituents. There are two types of teichoic acids: **wall teichoic acid (WTA)**, covalently linked to peptidoglycan, and **membrane teichoic acid**, covalently linked to membrane glycolipid. Because the latter are intimately associated with lipids, they have been called **lipoteichoic acids (LTA)**. The lengths of the **teichoic** acid chain and the nature and location of the substituents vary from species to species and sometimes between strains within a species. Because they are negatively charged, teichoic acids are partially responsible for the negative charge of the cell surface as a whole.

Together with peptidoglycan, WTA and LTA make up a polyanionic network or matrix that provides functions relating to the elasticity, porosity, tensile strength, and electrostatic properties of the envelope. Teichoic acids are found only in Gram-positive cells and constitute major antigenic determinants of their cell surface individuality.

Beside murein and teichoic acids gram-positive walls usually have lesser amounts of other molecules. Some are polysaccharides, such as the group-specific antigens of streptococci; others are proteins, such as the M protein of group A streptococci. Some protein components of the cell wall promote colonization by sticking the bacteria to the surfaces of host cells and belong to adhesins.

Comparison of gram-positive and gram-negative cell walls

| Characteristic | Gram-Positive | Gram-Negative |
|---|--|-------------------------------------|
| Number of peptidoglycan layers | Up to 40 | 1–2 |
| Overall thickness | Thicker (20–80 nm) | Thinner (8–11 nm) |
| Specific compounds | Teichoic acids Lipoteichoic acids | Lipopolysaccharides Lipoproteins |
| Interbridges between tetra peptides of neighbor glycan chains | Indirect via five residues of glycine | Direct |
| Outer membrane | No | Yes |
| Periplasmic space | Narrow | Extensive |
| Porin proteins | No | Yes |
| Permeability | More penetrable | Less penetrable |
| Secretion systems | No | Yes |
| Flagella fixation in cell envelope | 2 rings | 4 rings |
| Main mechanisms of genetic exchange | Transduction | Conjugation |
| Cell wall deficient forms in vitro | Protoplasts | Spheroplasts |
| Ability to produce spores | Yes (Clostridium spp. and Bacillus spp.) | No |
| Ability to produce long filamentous and branching cells | Yes (Actinomyces spp.) | No |
| Susceptibility to Lysozyme | Yes | No |
| Adhesion by pili | No | Yes |
| Pathogenicity islands | No | Yes |
| Gram stain | Violet | Red |

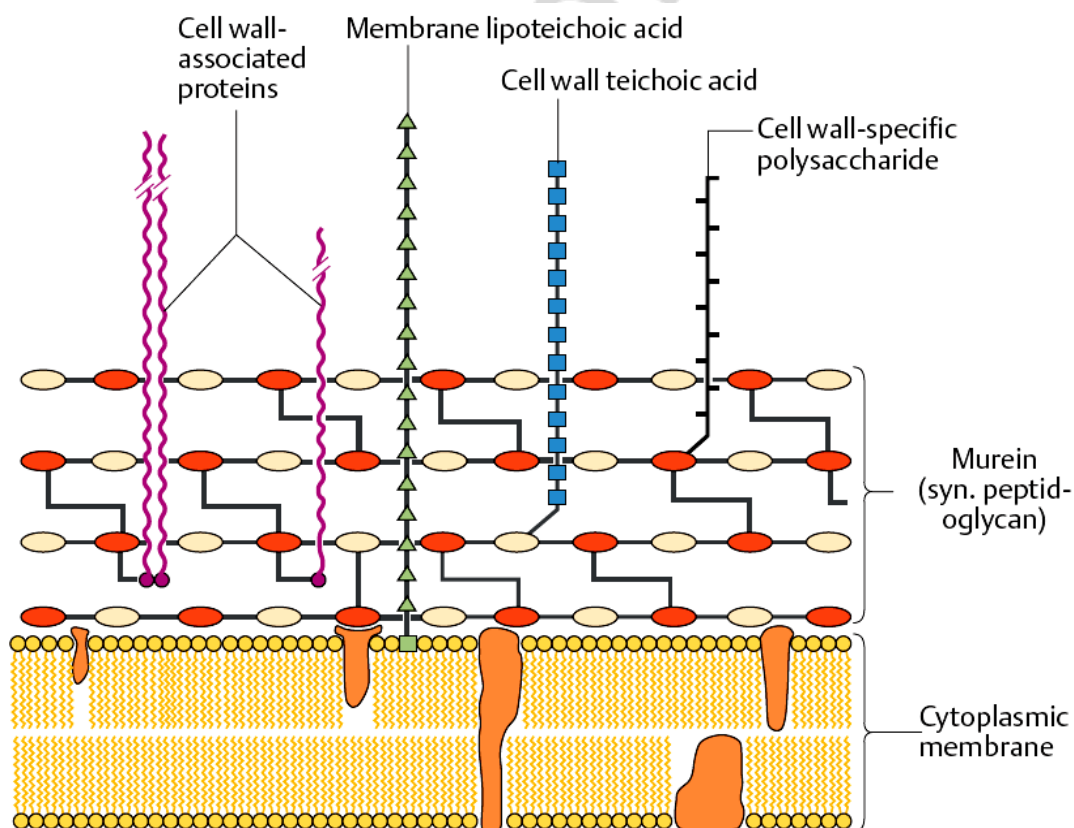

Figure 2.3. The cell wall of gram-positive bacteria

The cell wall of gram-negative bacteria.

The gram-negative cell wall has a single-layered peptidoglycan around the cell and contains an extra layer above peptidoglycan — an outer membrane (Fig. 2.4).

There is a gel-like substance, the periplasmic gel, with little cross-linking locating between inner and outer membranes. The periplasmic space is approximately 20–40 % of the cell volume. The periplasmic proteins include binding proteins for specific substrates (e.g. amino acids, sugars, vitamins, and ions), hydrolytic enzymes (e.g. alkaline phosphatase and 5'-nucleotidase) that break down nontransportable substrates into transportable ones, and detoxifying enzymes (e.g. beta-lactamase and aminoglycoside-phosphorylase) that inactivate certain antibiotics.

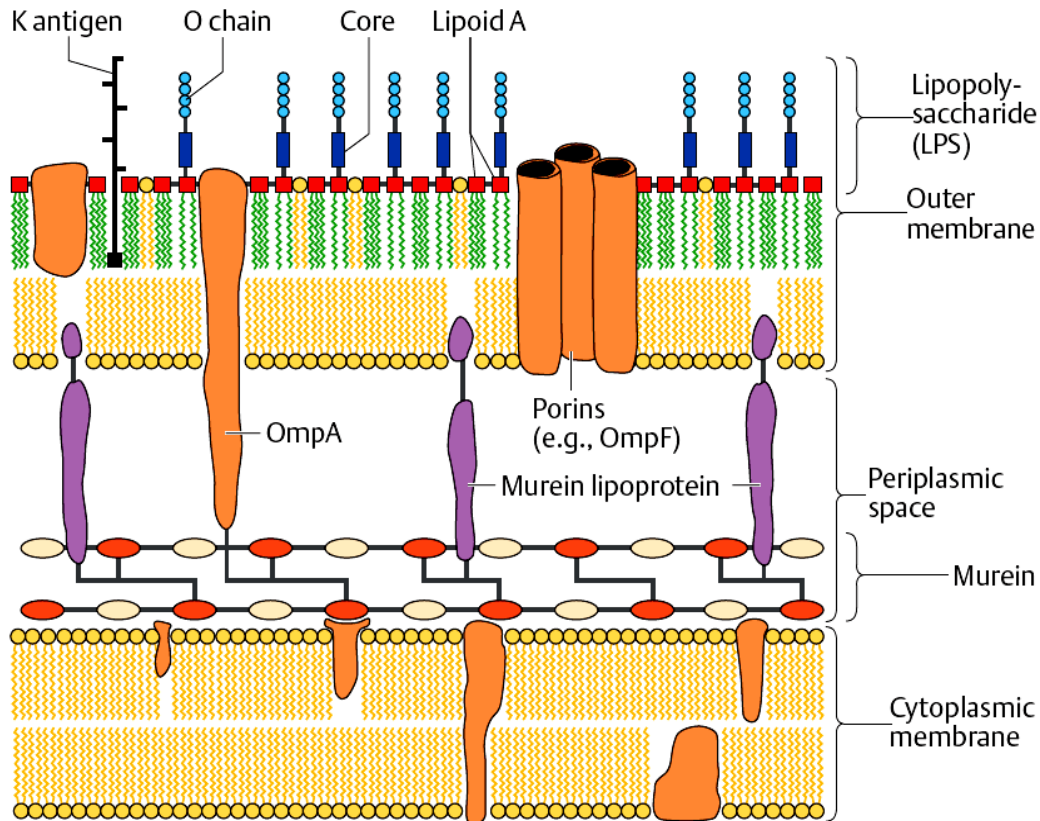

Figure 2.4. The cell wall of gram-negative bacteria

Outer membrane. It is a bilayered structure. The inner layer resembles the cell membrane and consists of phospholipids anchored by means of lipoproteins to the peptidoglycan layer below. The uppermost layer of the outer membrane contains *lipopolysaccharide (LPS)*, outer membrane proteins, porins, outer membrane-associated proteins.

Porins form special channels in outer membrane that permit the passive diffusion of low-molecular-weight hydrophilic compounds like sugars, amino acids, and certain ions. The permeability of the outer membrane varies widely from one gram-negative species to another; in *Pseudomonas aeruginosa*, for example, which is extremely resistant to antibacterial agents, the outer membrane is 100 times less permeable than that of *E coli*.

OmpA (outer membrane protein A) and the murein lipoprotein form a bond between outer membrane and murein. Other Omps are transport proteins.

Outer membrane-associated proteins enable bacteria to attach to host cell receptors.

The outer membrane represents an extra barrier in gram-negative bacteria that makes them more resistant to antimicrobials such as dyes and disinfectants. Treating infections caused by gram-negative bacteria often requires different drugs from gram-positive infections, especially drugs that can cross the outer membrane. The *lipopolysaccharide* can cause fever and shock reactions and have been referred to as *endotoxin*.

Lipopolysaccharide (LPS). The three-part lipopolysaccharide complex (LPS) of Gram-negative bacteria consists of the lipoid A, the core polysaccharide, and the O-specific polysaccharide chain.

Lipoid A is responsible for the toxic effect. It stimulates macrophages via CD14 receptor to produce interleukin 1 (IL-1) and tumor necrosis factor (TNF) that induce an increased synthesis of prostaglandin E2 in the hypothalamus, thus resulting in fever. Other direct and indirect endotoxin effects include granulopoiesis stimulation, aggregation and degeneration of thrombocytes, intravascular coagulation due to factor VII activation, a drop in blood pressure, and cachexia. LPS can also activate the alternative complement pathway. Release of large amounts of endotoxin can lead to septic (endotoxic) shock.

The polysaccharide **core** includes two characteristic sugars, **ketodeoxyoctanoic acid (KDO)** and a heptose.

The **O-specific polysaccharide chain** (syn. O antigen) consists tri-, tetra- or pentasaccharides repeating many times. These molecules exhibit structural and antigenic diversity even within a single species resulting in a large number of antigenic variants. Some gram-negative bacteria (e.g. *Neisseria meningitidis*, *Neisseria gonorrhoeae*, *Haemophilus influenzae*, and *Haemophilus ducreyi*) have relatively short LPS, and they are more properly termed **lipooligosaccharides (LOS)**. LOS is an important virulence factor. Epitopes have been identified on LOS which mimic host structures and may enable these organisms to evade the immune response of the host.

Gram stain: medical application, principles, procedure for Gram stain.

Gram staining is an empirical method of differentiating bacterial species into two large groups (Gram-positive and Gram-negative) based on the chemical and physical properties of their cell walls.

The method is named after its inventor, the Danish scientist Hans Christian Gram (1853–1938), who developed the technique in 1884 to discriminate between two types of bacteria with similar clinical symptoms: *Streptococcus pneumoniae* (also known as the *pneumococcus*) and *Klebsiella pneumoniae* bacteria. The word Gram is always spelled with a capital, referring to the name of the inventor of the Gram staining. The Gram stain is a direct method, since the cells themselves retain dye. Since many Gram positive bacteria tend to become Gram negative with age, the Gram stain should be used with overnight cultures. Sample from the edge of a colony, where cells are actively growing. The stains you use in this laboratory will stain hands and clothing as well as bacteria.

There are four basic steps of the Gram stain, which include applying a primary stain (crystal violet) to a heat-fixed smear of a bacterial culture, followed by the addition of a trapping agent (Gram's iodine), rapid decolorization with alcohol or acetone, and *counterstaining* with safranin or basic fuchsin.

Gram positive bacteria have a thick mesh-like cell wall made of peptidoglycan (50–90 % of cell wall), which stains purple while Gram-negative bacteria have a thinner layer (10 % of cell wall), which stains pink.

Crystal violet penetrates through the cell wall, cell membrane and interacts with negatively charged components of bacterial cells and stains both Gram-positive and Gram-negative cells purple. Iodine interacts with Crystal violet and forms large complexes of crystal violet and iodine within the inner and outer layers of the cell. Iodine is often referred to as a mordant, but is a trapping agent that prevents the removal of the complex and therefore color from the cell.

When a decolorizer such as alcohol or acetone is added the Crystal violet –Iodine complexes are washed from the Gram-negative cell along with the outer membrane. In contrast, the large Crystal violet –Iodine complexes become trapped within the Gram-positive cell due to the multilayered nature of its peptidoglycan. The decolorization step is critical and must be timed correctly; the crystal violet stain will be removed from both Gram-positive and negative cells if the decolorizing agent is left on too long (a matter of seconds).

After decolorization, the Gram-positive cell remains purple and the Gram-negative cell loses its purple color. Counterstain, which is usually positively charged safranin or basic fuchsin, is applied last to give decolorized Gram-negative bacteria a pink or red color.

Application: the Gram stain is routinely used as an initial procedure in the identification of an unknown bacterial species.

Gram-positive bacteria: *Bacillus*, *Listeria*, *Staphylococcus*, *Streptococcus*, *Enterococcus*, *Diplococcus pneumoniae*, *Clostridium*, *Mycobacterium*, *Actinomyces*, *Corynebacterium*, *Nocardia*.

Gram-negative bacteria: family *Enterobacteriaceae* (genus *Escherichia*, *Klebsiella*, *ersinia*, *Salmonella*, *Shigella*, *Citrobacte e.a.*), *Pseudomonas*, *Campylobacterium*, *Helicobacter*, *Neisseria*, *Moraxella*, *Spirochetales*, *Rickettsia*, *Bacteroides*, *Porphyromonas*, *Prevotella*, *Vibrio*, *Brucella*, *Francisella*, *Bordetella*.

The technique of Gram stain:

Requirements: grease-free slide, water resistant marker, sterile distilled water (or isotonic solution), bacteriological loop, source of flame, microbial culture (from broth or agar media), crystal violet (1 % aqueous solution), iodine, decolorizer (ethanol), basic fuchsin.

Procedure:

1. Prepare a heat-fixed bacterial smear on a slide.
2. Place a slide with a bacterial smear on a staining rack.
3. Cover the smear completely with a few drops of a solution of crystal violet, a purple basic dye and stain for 1 minute.
4. Pour off the stain and rinse the smear with water.
5. Flood slide with several drops of iodine, left for 1 minute and then rinse again.
6. Flood slide with ethanol for 30 seconds.
7. Wash slide thoroughly with water to remove ethanol.
8. Flood slide with a few drops of basic fuchsin for 1 minute.
9. Wash slide thoroughly with water.
10. Gently blot dry (do not rub) with clean white paper towel.

Bacterial forms with defective cell wall (protoplasts, spheroplasts and L forms): factors inducing cell wall removal, medical importance of L-forms.

Some bacteria that ordinarily have a cell wall can lose it. There are three cell wall-deficient forms of microorganisms: **L forms** or L-phase variants (for the Lister Institute, where they were discovered), **protoplasts** and **spheroplasts**. L forms arise **in vivo** spontaneously from a mutation in the wall-forming genes, or they can be induced artificially by treatment with a chemical such as lysozyme, disrupting the cell wall, or penicillin, inhibiting cell wall synthesis. L forms able to grow and divide. L forms can be cultivated on special media having the right osmotic strength. L forms can be reverse or stable. Some L forms are able to resume normal cell wall synthesis and thus can revert to the normal bacillary form upon removal of the inducing stimulus. Others are stable and never revert. The factor that determines their capacity to revert may be the presence of residual peptidoglycan, which normally acts as a primer in its own biosynthesis.

Medical significance of L forms. They cause chronic infections. The formation of L forms in the host may lead to their persistence as they display low antigenicity and become sequestered in protective regions of the body. Their reversion to the bacillary form can produce relapses of the infection. Since L-form infections are relatively resistant to antibiotic treatment (beta-lactams), they present special problems in chemotherapy.

In vitro in osmotically protective media when a gram-positive cell is exposed to lysozyme or penicillin it loses the cell wall completely and becomes a **protoplast**, a fragile cell bounded only by a membrane that is highly subject to lysis. A gram-negative cell exposed to these same substances loses its peptidoglycan but retains its outer membrane, and becomes a **spheroplast** — a less fragile but nevertheless weakened. Protoplasts and spheroplasts are unable to divide. Protoplasts in low-

osmotic-strength media lyse; if the osmotic strength of the medium is raised to balance the internal osmotic pressure protoplasts can survive.

The composition, function of capsule. Detection of capsule using negative staining.

Many bacteria synthesize large amounts of extracellular polymer — **glycocalyx** — when growing in their natural environments. Glycocalyx (capsule and s-layer) is defined as the polysaccharide-containing material lying outside the cell. Capsule is a superficial well-defined hydrophilic gel-like layer closely surrounding the cell and displaying protective and virulent properties. According to size the capsules can be classified as macro (can be seen in light microscope) and micro (can be seen in electron microscope). Most capsules are polysaccharides made of single (homopolymers) or multiple types (heteropolymers) of sugar residues; some are simple polypeptides, such as the polymer of D-glutamic acid in *Bacillus anthracis*, the causative agent of anthrax. When cultured on solid media encapsulated bacteria give rise to smooth, often mucus-like colonies. Extracellular polymer is synthesized by enzymes located at the surface of the bacterial cell.

Capsules are constantly formed by a few pathogenic bacteria, such as *Streptococcus pneumoniae*, *Haemophilus influenzae*, *Bacillus anthracis*, *Klebsiella pneumoniae*, *Neisseria meningitidis*. Encapsulated bacteria that mutate to nonencapsulated forms usually lose their pathogenicity. In the rest microorganisms synthesis of capsules is greatly dependent on growth conditions.

Functions of the capsule:

1. It displays antigenic properties (K-antigen) and induce immune reaction in human body;
2. It is responsible for the invasiveness of pathogenic bacteria and protects them against phagocytosis. By escaping phagocytosis, the bacteria are free to multiply and infect body tissues. *Klebsiella pneumoniae* producing large capsule frequently causes chronic respiratory infections.
3. It is responsible for the adherence of bacteria to surfaces in their environment, including the cells of plant and animal hosts. *S. mutans*, for example, owes its capacity to adhere tightly to tooth enamel to surface polysaccharides. The capsule of some bacteria is so highly adherent that it is responsible for persistent colonization of nonliving materials such as plastic catheters, intrauterine devices, and metal pacemakers that are in common medical use.

Because the capsule does not react with most stains, it is often negatively stained with India ink, or it may be demonstrated by special positive stains.

Negative stain for capsule presence detection (Fig. 2.5).

1. Mix the drop of material and the drop of Indian ink on a slide.
2. Spread the drop across the slide using the edge of another slide as a spreader. This same procedure is used for blood smears.
3. Dry and fix the slide.
4. Stain the slide with fuchsin solution for 1 minute.
5. Wash thoroughly and dry the slide.

Indian ink makes the dark background for capsular bacteria. **Capsules** are visualized as **colorless halo** around **red microbial bodies** at the dark background.

The composition, function of flagella, methods for their detection.

Bacterial flagella are thread-like appendages composed entirely of protein, 12–30 nm in diameter. They are the organs of locomotion.

Flagella vary both in number and arrangement (Fig. 2.5): our types of arrangement are known: **monotrichous** (single polar flagellum), **lophotrichous** (multiple flagella emerging from one pole), **amphitrichous** (flagella at both poles of the cell) and **peritrichous** (flagella dispersed randomly over the surface of the entire cell).

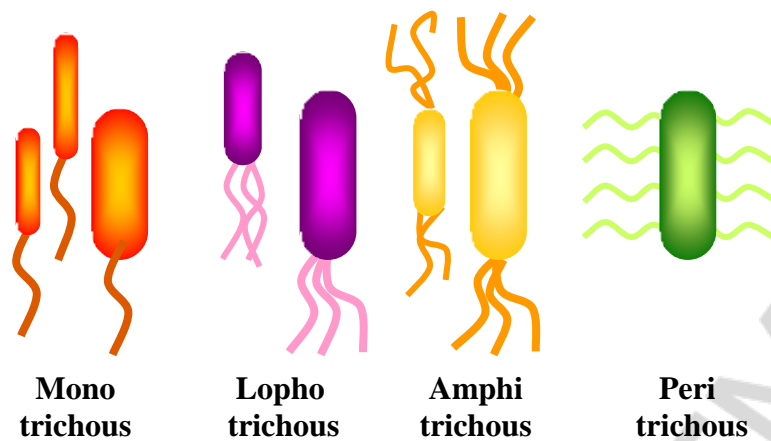

Figure 2.5. Flagella arrangements in bacteria

Flagella has three distinct parts: the filament, the hook (sheath), and the basal body. The **filament**, a helical structure composed of proteins, is approximately 20 nm in diameter and varies from 1 to 70 nm in length. It is inserted into a curved, tubular hook. The hook is anchored to the cell by the basal body. The basal body bears a set of rings, one pair in gram-positive bacteria and two pairs in gram-negative bacteria. This arrangement permits the hook with its filament to rotate 360 (Fig. 2.6).

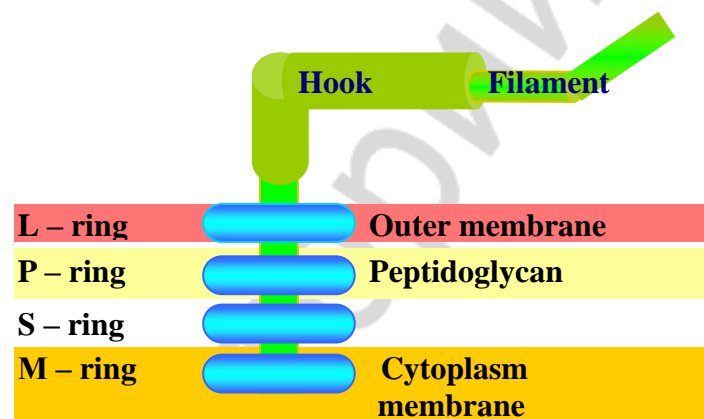

Figure 2.6. Flagellum structure

A bacterial flagellum is made up of several thousand molecules of a protein subunit called **flagellin**. They are highly antigenic (**H antigens**), and some of the immune responses to infection are directed against these proteins. Over 40 gene products are involved in assembly of flagellum. Most bacteria possess external flagella. But corkscrew-shaped bacteria called **spirochetes** have **internal flagella**, or *axial filaments*, locating in periplasmic space.

Special stains or electron microscope preparations must be used to see arrangement, since flagella are too minute to be seen in live preparations with a light microscope. Often it is sufficient to know simply whether a bacterial species is motile. One way to detect motility is to stab a tiny mass of cells into a soft (semisolid) medium. Growth spreading rapidly through the entire medium is indicative of motility. Alternatively, cells can be observed microscopically with a hanging drop slide.

The composition, function of pili (fimbriae) and methods for their detection.

Pili or fimbriae are proteinaceous, filamentous, polymeric hair-like projections expressed on the surface of bacteria. Pili were first noted in early electron microscopic investigations as non-flagellar, filamentous appendages of bacteria. In 1958 Duguid designated these appendages “fimbriae” (plural, from Latin for thread or fibre) and correlated their presence with the ability of *Escherichia coli* to agglutinate red blood cells.

They are shorter and finer than flagella. They are composed of structural protein subunits termed **pilins**. Pilin molecules are arranged helically to form a straight cylinder that does not rotate and lacks a complete basal body. Minor proteins termed **adhesins** are located at the tips of pili and are responsible for the attachment properties. Two classes can be distinguished: ordinary pili, which play a role in the adherence of symbiotic and pathogenic bacteria to host cells, and sex pili, which are responsible for the attachment of donor and recipient cells in bacterial conjugation. Pili can be classified on: 1) thick, rigid pili; 2) thin, flexible pili; 3) atypical structures; 4) conjugative pili. On average, one to ten conjugative pili and up to more than 400 fimbriae may be present on the surface of a bacterial cell.

Functions of pili:

- 1) some bacteria are able to make pili of different antigenic types (**antigenic variation**) thus avoiding of immune system;
- 2) like capsules, pili inhibit the phagocytic ability of leukocytes;
- 3) pili provide the bacteria with adherent properties: adhesins can mediate the interaction of bacteria with each other, with inanimate surfaces, and with tissues and cells in susceptible host organisms;
- 4) pili can act as receptors for bacteriophages;
- 5) pili participate in the adaptation, survival and spread of commensal bacteria.

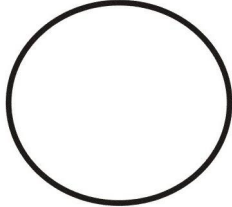
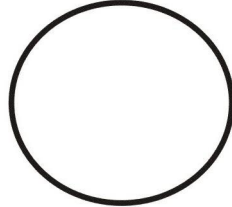
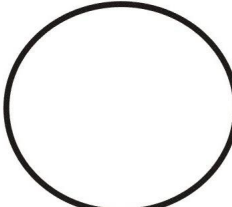
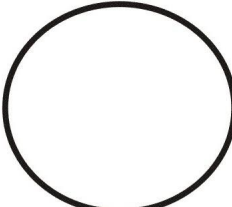
| Laboratory exercises | Laboratory report |
|---|---|
| <p>1. Prepare heat-fixed slide of the mixed culture of <i>Escherichia coli</i> (gram-negative) and <i>Staphylococcus aureus</i> (gram-positive), Gram stain, examine under oil immersion, complete the report.</p> <p>2. Carry out detection of capsule in <i>Klebsiella pneumoniae</i> using the negative staining, examine slide under oil immersion, complete the report</p> | <div style="display: flex; justify-content: space-around;"> <div style="text-align: center;">  Smear _____ Stain _____ </div> <div style="text-align: center;">  Smear _____ Stain _____ </div> </div> |
| <p>Complete the drawings of seen in demonstration room slides:</p> <p>1. Slide with capsule of <i>Klebsiella pneumoniae</i>, negative staining</p> <p>2. Slide with mixture of <i>Escherichia coli</i> (gram-negative) and <i>Staphylococcus aureus</i> (gram-positive), Gram stain</p> | <div style="display: flex; justify-content: space-around;"> <div style="text-align: center;">  Smear _____ Stain _____ </div> <div style="text-align: center;">  Smear _____ Stain _____ </div> </div> |
| <p>Signature of the tutor _____</p> | |

1. What is the function of the iodine solution in the Gram stain? If it were omitted, how would staining results be affected?
2. What is the purpose of the alcohol solution in the Gram stain?
3. What counterstain is used? Why is it necessary? Could colors other than red be used? What is the advantage of the Gram stain over the simple stain?
4. Describe at least two conditions in which an organism might stain gram variable.
5. Which step is the most crucial or most likely to cause poor results in the Gram stain? Why?
6. Why must young cultures be used when doing a Gram stain? What is meant by gram variable?
7. What part of the bacterial cell is most involved with Gram staining, and why?
8. What is an advantage of negative staining?
9. Why is negative staining also called either indirect or background staining?

Practical class № 3

MICROSCOPIC METHOD OF EXAMINATION. THE MORPHOLOGY AND FINE STRUCTURE OF BACTERIA. DIFFERENTIAL METHODS OF STAINING

Suggested reading for self-study. The cytoplasmic membrane: structure, function. The most important bacterial cytoplasmic membrane proteins. Bacterial core: cytoplasm, cytoplasmic structures (nucleoid, plasmids, ribosomes, and mesosomes). Inclusion bodies — storage granules (starch, fat, sulfur, polymetaphosphate (volutin)). Methods for nucleoid and volutin detection. Loeffler and Neisser stain for volutin granules. Acid-fast bacteria and unique properties of their cell wall. Ziehl–Neelsen acid-fast staining: medical application, principle, procedure.

Resting forms of microorganisms. Bacterial endospores: medical importance, properties of endospore, the stages of endospore formation, detection methods. Spore stain using Ozheshko method: principle, procedure.

The cytoplasmic membrane: structure, function. The most important bacterial cytoplasmic membrane proteins.

Cytoplasmic membrane is basically a double layer of phospholipids with numerous proteins integrated into its structure. It is a very thin (5–10 nm), flexible sheet molded completely around the cytoplasm. Bacterial cell membranes have this typical structure, containing primarily phospholipids (making up about 30–40 % of the membrane mass) and proteins (contributing 60–70 %). Major exceptions to this description are the membranes of mycoplasmas, which contain high amounts of sterols — rigid lipids that stabilize and reinforce the membrane — and the membranes of archaea, which contain unique branched hydrocarbons rather than fatty acids. The cell membrane is a *selectively permeable* structure with special carrier mechanisms for passage of nutrients into the cell and the discharge of wastes. The glycocalyx and cell wall can bar the passage of large molecules, but they are not the primary transport apparatus. Since bacteria have none of the eucaryotic organelles, the cell membrane provides a site for functions such as energy reactions, nutrient processing, and synthesis. The most important cell membrane proteins are permeases, enzymes for the biosynthesis of the cell wall, transfer proteins for secretion of extracellular proteins, sensor or signal proteins, and respiratory chain enzymes.

Permeases. Required for active transport of nutrients from outside to inside against a concentration gradient.

Biosynthesis enzymes. Cell membrane help synthesize structural macromolecules to be incorporated into the cell envelope and appendages.

Secretion system proteins. The cell membrane is involved in *secretion*, or the discharge of a metabolic products or toxins into the extracellular environment. Four secretion systems differing in structure and mode of action have been described to date. Proteins are moved out of the cell with the help of these systems. A common feature of all four is the formation of protein cylinders that traverse the cytoplasmic membrane and, in Gram-negative bacteria, the outer cell wall membrane as well.

Sensor proteins (syn. signal proteins). Sensor proteins are required to transmit information from the cell's environment into its interior. Works as follows: signal molecules binds to a receiver module extending outward — activation of transmitter module — transfers the information to a regulator protein — activation or deactivation of one or more genes.

Respiratory chain enzymes. Most enzymes of respiration and ATP synthesis reside in the cell membrane since prokaryotes lack mitochondria.

Bacterial core: cytoplasm, cytoplasmic structures (nucleoid, plasmids, ribosomes and mesosomes). Methods for nucleoid detection.

The cytoplasm contains a large number of low- and high-molecular weight substances, RNA and approximately 20 000 ribosomes per cell. Bacteria have 70S ribosomes comprising 30S and 50S subunits. Bacterial ribosomes function as the organelles for protein synthesis.

The cell membrane in several sites forms internal pouches in the cytoplasm called **mesosomes**. Mesosomes presumably increase the internal surface area available for membrane activities. Some of the proposed functions of mesosomes are to participate in cell wall synthesis and to guide the duplicated bacterial chromosomes into the two daughter cells during cell division.

Nucleoid (nucleus equivalent). The “cellular nucleus” in prokaryotes consists of a tangle of double-stranded DNA, not surrounded by a membrane and localized in the cytoplasm. In *E. coli* (and probably in all bacteria), it takes the form of a single circular molecule of DNA. The genome of *E. coli* comprises 4.631 10⁶ base pairs (bp) that code for 4288 different proteins. The genomic sequence of many bacteria is known. DNA is the central database that stores and provides the information for making the macromolecules that compose the cell and allow it to function.

Plasmids. The plasmids are nonessential genetic structures. These circular, twisted DNA molecules are 100–1000 times smaller than the nucleoid genome structure and reproduce autonomously. The plasmids of bacteria pathogenic to human often bear important genes determining resistance and virulence.

The cytoplasm is also frequently used to store reserve substances (glycogen depots, polymerized metaphosphates, lipids).

Inclusion bodies — storage granules (starch, fat, sulfur, polymetaphosphate (volutin)). Methods for nucleoid and volutin detection. Loeffler and Neisser staining of volutine granules.

Cytoplasmic inclusions. Under certain growth conditions bacteria may produce insoluble storage products that are seen under the electron microscope as electron-lucent (clear) areas in the cytoplasm. Some of inclusion bodies can also be seen by light microscopy after specific staining. Usually the granules used for the storage of energy or as a reservoir of structural building blocks. Some cellular inclusions are bounded by a thin nonunit membrane consisting of lipids or proteins, which serves to separate the inclusion from the cytoplasm proper.

Non-membrane inclusions.

Volutin granules, syn. polyphosphate [PO₃]_n, metachromatic granules. They were named after *Spirillum volutans* in whom they were initially detected. They are typical for corynebacteria, especially *C. diphtheria* and mycobacteria. Volutin granules sometimes termed metachromatic granules because they stain with change in color. The granules contain polymerized inorganic phosphate and can be degraded and used as sources of phosphate for nucleic acid, ATP and phospholipid synthesis to support growth. In some cases, nucleic acid, protein, and lipid are associated with these granules. Under the light microscope volutin granules appear red-violet after staining with methylene blue, and the cytoplasm appears blue.

Polysaccharide Granules. Polysaccharide granules contain either glycogen or starch as an energy or carbon reserve. After staining with iodine, glycogen granules appear reddish-brown, while starch granules appear blue.

Membrane inclusions.

Carboxysomes. Carboxysomes are polyhedral inclusion bodies that contain the enzyme ribulose 1,5-diphosphate carboxylase. This is responsible for carbon dioxide fixation in cyanobacteria.

Lipid bodies. Lipid is stored as an energy or carbon reserve in the form of poly-β-hydroxybutyric acid. Lipid bodies are highly retractile inclusions in the cytoplasm and can be stained with Sudan black, in contrast to other bacterial contents. PHB is produced when the source of nitrogen, sulfur, or phosphorous is limited and there is excess carbon in the medium.

A granules of elemental sulfur. Variety of prokaryotes are capable of oxidizing reduced sulfur compounds such as hydrogen sulfide and thiosulfate, producing intracellular granules of elemental sulfur. As the reduced sulfur source becomes limiting, the sulfur in the granules is oxidized, usually to sulfate, and the granules slowly disappear.

Gas vesicles. Gas vesicles or vacuoles are found primarily in aquatic bacteria. They are composed of a series of hollow cylinders in the bacterial cytoplasm. An outer protein layer excludes water and ions, but allows gases to enter to provide cell buoyancy.

Loeffler and Neisser stain for volutin granules detection.

Procedure of Neisser stain for volutin granules:

1. Prepare and fix the slide made from liquid or solid medium culture.
2. Stain the slide with Neisser methylene blue dye for 3–5 minutes.
3. After incubation add Lugol iodine solution for 10–30 seconds.
4. Wash the slide.
5. Counterstain with chrysoidin solution for 1 minute.
6. Wash thoroughly and blot slide dry with bibulous paper. Be careful not to rub the smear when drying the slide because this will remove the stained bacteria.
7. Examine under the oil immersion objective.

Results: Volutin granules stain **dark blue**, vegetative parts of bacteria stain **yellow-brown**.

Procedure of Loeffler stain for volutin granules detection:

Requirements: 24- to 48-hour culture of *Corynebacterium spp.*, microscope, clean microscope slides, filter paper, inoculating loop, sterile distilled water, burner, Loeffler's alkaline methylene blue, immersion oil, lens paper and lens cleaner.

1. Prepare fixed smear of 24- to 48-hour culture of *Corynebacterium spp.* and place it on a staining rack.
2. Stain one slide with alkaline methylene blue for 5 minutes;
3. Wash stain off slide with water for a few seconds, blot slide dry with filter paper. Be careful not to rub the smear when drying the slide because this will remove the stained bacteria.
4. Examine under the oil immersion objective.

Results: Volutin granules stain **violet-blue**, vegetative parts of bacteria stain **blue**.

Acid-fast bacteria and unique properties of their cell wall. Ziehl–Neelsen acid-fast staining: medical application, principle, procedure.

The **Ziehl–Neelsen stain**, also known as the **acid-fast stain**, was first described by two German doctors: Franz Ziehl (1859 to 1926), a bacteriologist, and Friedrich Neelsen (1854 to 1894), a pathologist. It is a special bacteriological stain used to identify acid-fast organisms, mainly mycobacteria and few other bacteria like *Nocardia*. Acid-fast bacteria have cell walls that contain large amounts of **waxes**, complex branched hydrocarbons (70 to 90 carbons long) known as **mycolic acids**. The cell wall is composed of peptidoglycan and an external asymmetric lipid bilayer; the inner leaflet of lipid bilayer contains mycolic acids linked to an arabinoglycan and the outer leaflet contains other extractable lipids. This hydrophobic structure of highly ordered lipid bilayer renders these bacteria resistant to many harsh chemicals including detergents and strong acids. In acid-fast bacteria the permeability of the cell wall to hydrophilic molecules is 100- to 1000-fold lower than in *E. coli* and may be responsible for the slow growth rate of mycobacteria.

The **Ziehl–Neelsen stain principle**. A smear of cells on a slide is flooded with carbolfuchsin and heated on a steam bath to drive the stain into the cells. Following this, the discolorization with acid is carried out. If a dye is introduced into acid-fast cells by brief heating or treatment with detergents, it cannot be removed by diluted acid, as in other bacteria. Non acid-fast bacteria are

contrasting with (blue or green) counterstain. Acid-fast bacteria (mycobacteria and some of the related actinomycetes) appear red; others take on the color of the counterstain — blue.

Requirements: a young slant culture of *Mycobacterium spp.* or a sputum specimen, microscope, clean microscope slides, filter paper, inoculating loop, sterile distilled water, burner, carbol fuchsin stain, forceps, methylene blue, immersion oil, lens paper and lens cleaner.

Ziehl–Neelsen acid-fast staining procedure:

1. Prepare heat fixed smear on a glass microscope slide.
2. Cover with filter paper and flood the slide with carbol fuchsin stain.
3. Heat the slide gently until it steams (2–3 min).
4. Pour off the carbol fuchsin and wash the slide thoroughly with water.
5. Decolorize by adding 5 % acid drop by drop until the slide remains only slightly pink. This requires 10 to 30 seconds and must be done carefully.
6. Rinse thoroughly with water for 5 seconds.
7. Flood slide with methylene blue counterstain for 3–5 min.
8. Wash with water, blot slide dry with filter paper, and examine under the oil immersion objective.

Resting forms of microorganisms. Bacterial endospores: medical importance, properties of endospores, the phases of endospore formation, detection methods. Spore stain using Ozheshko method: principle, procedure.

Resting (dormant) forms of microorganisms have following features: absence/low metabolic activity, lack of cell division, additional protective layers, and resistance to hostile factors. Examples: bacterial and fungal spores, reticular bodies of Chlamydia, proviruses, small forms of Rickettsia, partially L forms.

Endospores are small, dehydrated, metabolically quiescent forms that are produced by some bacteria in response to nutrient limitation or other unfavorable environmental factors. Spores can be located in terminal, subterminal, and central parts of bacterial cell.

Members of several bacterial genera are capable of forming **endospores**. The two most common are gram-positive rods: the aerobic genus *Bacillus* and the obligate anaerobic genus *Clostridium*. The other bacteria known to form endospores are *Thermoactinomyces*, *Sporolactobacillus*, *Sporosarcina*, *Sporotomaculum*, *Sporomusa* and *Sporohalobacter*.

The process, of sporulation is triggered by near depletion of any of several nutrients (carbon, nitrogen, or phosphorous). The bacterial endospore is not a reproductive structure. Under adverse conditions one cell forms one internal spore that is liberated when the mother cell undergoes autolysis. When returned to favorable nutritional conditions, the spore germinates to produce a single vegetative cell. Spores, therefore, are survival rather than reproductive devices.

The spore is a resting cell that may persist for a long time (centuries). One record describes the isolation of viable spores from a 250-million-year-old salt crystal. Initial analysis of this ancient microbe indicates it is a species of *Bacillus* that is genetically unique.

The spores are highly resistant to desiccation, extremes of pH, heat (including boiling water), freezing, chemical agents (alcohols, acids), enzymes, and ultraviolet radiation. The heat resistance of the spores is their most important quality from a medical point of view, since heat sterilization procedures require very high temperatures to kill them effectively. They resist ordinary cleaning methods that use boiling water, soaps, and disinfectants. Hospitals and clinics must take precautions to guard against the potential harmful effects of spores in wounds. Spore destruction is a particular concern of the food-canning industry. Several endosporeforming species cause food spoilage or poisoning. Ordinary boiling (100 °C) will usually not destroy such spores, so canning is carried out in pressurized steam at 120 °C for 20 to 30 minutes. Such rigorous conditions will ensure that the food is sterile and free from viable bacteria.

Potential contributing factors to spore heat, radiation and chemical resistance include the low water content of the spore, the presence of a large amount of a substance found only in spores,

calcium dipicolinate and their thick wall structures. Special coats surrounding the spore include a spore membrane (equivalent to the former cell membrane); a thick cortex composed of a special form of peptidoglycan; a coat consisting of a cysteine-rich, keratin-like, insoluble structural protein; and, finally, an external lipoprotein and carbohydrate layer called an exosporium.

Bacterial sporulation. The process of sporulation from commitment to release of the mature spore lasts about 8 hours. Sporulation consists of several distinct morphological stages:

1. Formation of two genomes and polarization of each to one pole of the cell.
2. Formation of a septum dividing the cell into two distinct chambers, a smaller compartment termed the prespore and a larger chamber known as the mother cell.
3. Engulfment of prespore and formation of prospore.
4. Maturation of spore: cortex synthesis and coat deposition.
5. Lysis of mother cell.
6. Free spore.
7. Germination.
8. Vegetation.

Bacterial germination. Bacterial germination is the change of an endospore from its resting stage to an actively growing vegetative cell. This takes place when the external environment is favorable for growth by the provision of essential nutrients and water. Germination is divided into three stages: activation, germination, and outgrowth.

The spore stain. Spores are most simply observed as intracellular refractile bodies in unstained cell suspensions or as colorless areas in cells stained by conventional methods. The spore wall is relatively impermeable, but treatment with acid prior to staining facilitates penetration of dyes across the spore coats. After treatment with an acid spores are stained by Ziehl–Neelsen method acid-fast. Acid-fast spores appear red; others take the color of the counterstain — blue.

Procedure:

1. Prepare a suspension of a culture on a slide, and add 0.5 % HCl. Heat the slide gently until it dry, wash and fix by heating.
2. Stain the smear using Ziehl–Neelsen method.

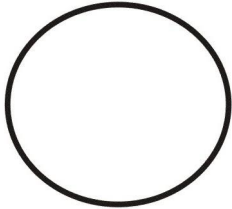
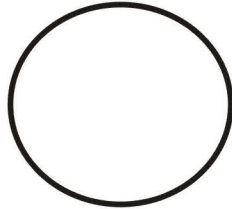
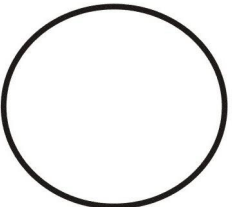
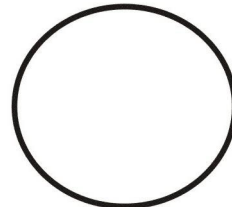
| Laboratory exercises | Laboratory report |
|--|--|
| <p>1. Prepare slide of the mixed culture of acid-fast and acid-labile microorganisms, staining using Ziehl–Neelsen method, examine under microscope, complete the report</p> | <div style="display: flex; justify-content: space-around; align-items: center;"> <div style="text-align: center;">  <p>Smear _____ Stain _____</p> </div> <div style="text-align: center;">  <p>Smear _____ Stain _____</p> </div> </div> |
| <p>Complete the drawings of seen in demonstration room slides:</p> <p>1. Slide with volutin granules of <i>Corynebacterium diphtheria</i>, Loeffler staining.</p> <p>2. Slide with volutin granules of <i>Corynebacterium diphtheria</i>, Neisser staining.</p> <p>3. Slide with spores of <i>Bacillus anthracis</i>, Ozheshko staining</p> | <div style="display: flex; justify-content: space-around; align-items: center;"> <div style="text-align: center;">  <p>Smear _____ Stain _____</p> </div> <div style="text-align: center;">  <p>Smear _____ Stain _____</p> </div> </div> |
| <p>Signature of the tutor _____</p> | |

1. For what diseases would you use an acid-fast stain?
2. What chemical is responsible for the acid-fast property of mycobacteria?
3. How should the acid-fast stain of a sputum specimen from a patient with suspected pulmonary Nocardia infection be performed?
4. Is a Gram stain an adequate substitute for an acid-fast stain? Why?
5. Are acid-fast bacteria gram positive or gram negative? Explain your answer.
6. Why is it important to know whether or not bacterial cells possess flagella, or endospores?
7. What do endospore stains have in common with the Ziehl–Neelsen acid-fast stain? Is bacterial sporulation a reproductive process? Explain.
8. Why is it important to determine the location of the endospore within the bacterial cell?
9. What is the purpose of the heat during the acid-fast staining procedure?
10. What is the function of the counterstain in the acid-fast staining procedure?
11. Why are endospores so difficult to stain?

Practical class № 4

MICROSCOPIC METHOD OF EXAMINATION. THE MORPHOLOGY OF THE SPIROCHETES, ACTINOMYCES, RICKETTSIAE, CHLAMYDIAE, MYCOPLASMAS

Suggested reading for self-study. Taxonomy, morphology, medical significance of the spirochetes. Methods for spirochetes morphology study. Romanowsky–Giemsa stain. Actinomyces: taxonomy, morphology and culture, medical significance. Rickettsiae: taxonomy, morphology, culture, medical significance and methods of examination. Chlamydiae: taxonomy, morphology, reproduction cycle (elementary and reticulate body), culture, medical significance and methods of examination. Mycoplasmas: taxonomy, morphology, culture, medical significance, methods of examination.

Methods for the motility detection of the living bacteria. Preparation of the hanging-drop and wet-mount slides. Dark-field light microscopy: the principle behind dark-field microscopy, light passage in dark-field condenser. Phase-contrast light microscope: basic principles behind phase-contrast microscopy. Fluorescence microscopy: principles behind the fluorescence microscopy.

Survey of Prokaryotic Groups with Unusual Characteristics

The bacterial world is so diverse certain types of bacteria exhibit such unusual qualities that they deserve special mention.

Spirochetes. Flexible helical microorganisms with periplasmic flagella. They are Gram-negative asporogenous. Due to periplasmic flagella they are motile, exhibiting rotation and flexion; can also creep over solid surfaces. The medically important genera *Treponema*, *Leptospira*, and *Borrelia* have been distinguished primarily by morphologic characters such as the nature of their spiral shape and the arrangement of flagella. Many spirochetes are difficult to see by routine microscopy. Although they are gram-negative, Spirochetes take aniline stains poorly or are too thin to fall within the resolving power of the light microscope. Thus, Spirochaetes may be seen by bright-field microscopy after staining by Romanowsky–Giemsa method (not by Gram!) or silver-deposition techniques, by dark-field microscopy, or by fluorescence microscopy following treatment with fluorochrome-labelled antibodies. By Romanowsky–Giemsa method *Treponema* stains in pale pink color, *Borrelia* in violet, *Leptospira* in red or pink. Species include anaerobes (obligate and facultative) and microaerophiles. The spirochaetal cell consists of a helical *protoplasmic cylinder* (or protoplast) covered by a “cell wall” of peptidoglycan and outer membrane (Fig. 4.1). They have well developed periplasmic space locating between cell membrane and peptidoglycan. One or more *periplasmic flagella* (syn. axial fibrils, axial filaments, endoflagella, periplasmic fibrils) arise at *each* end of the protoplasmic cylinder and wind around the protoplasmic cylinder locating in periplasm. The periplasmic flagellum is similar in ultrastructure to the prokaryotic flagellum; the number of periplasmic flagella per cell is a stable characteristic of the various species and genera of spirochaetes.

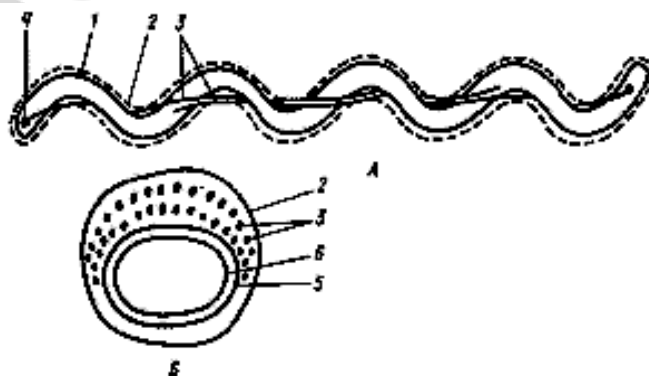

Figure 4.1. Morphology of Spirochetes:

1 — Protoplast; 2 — Outer membrane; 3 — Endoflagella; 4 — Peptidoglycan; 6 — Periplasmic space

Parasitic spirochetes grow more slowly in vitro than most other disease-causing bacteria. Some species, including the causative agent of syphilis, have not been grown beyond a few generations in cell culture.

Treponema. The cells typically do not have hooked ends.

Borrelia. Arthropod-borne spirochetes. Members of the genus *Borrelia* are comparatively larger, and they contain 3 to 10 irregularly spaced and loose coils with an abundance (30–40) of periplasmic flagella. The nutritional requirements of *Borrelia* are so complex that the bacterium can be grown in artificial media only with difficulty. Human infections with *Borrelia*, termed borrelioses, are all transmitted by some type of arthropod vector. The two most important human diseases are relapsing fever and Lyme disease.

Leptospira. Leptospire are typical spirochetes marked by tight, regular, individual coils with a bend or hook at one or both ends. There are only two species in the genus: *Leptospira interrogans*, which causes leptospirosis in humans and animals, and *L. biflexa*, a harmless, free-living saprobe.

Rickettsias. Small short rods, usually intracellular bacteria transmitted by arthropods. Rickettsias are distinctive, very tiny, gram-negative bacteria. Unique properties of Rickettsia: 1) Pleomorphic — may have a morphology of coccobacteria, rods, and filamentous cells; 2) circulate between a mammalian host and blood-sucking arthropods; 3) obligate intracellular parasites — they cannot survive or multiply outside a host cell and cannot carry out metabolism completely on their own, so they are closely attached to their hosts; 4) can be cultured in cell cultures or laboratory animals, but not on culture media as bacteria. Several important human diseases are caused by rickettsias. Among these are Rocky Mountain spotted fever, caused by *Rickettsia rickettsii* (transmitted by ticks), and epidemic typhus, caused by *Rickettsia prowazekii* (transmitted by lice).

Chlamydias. Gram-negative bacteria which are obligate intracellular parasites in eukaryotic cells with two-component life style. Because of their tiny size and obligately parasitic lifestyle, they were at one time considered a type of virus. Later studies indicated that their structure was clearly procaryotic. Unique properties of *Chlamydia spp.*: 1) small size and ability to go through bacterial filters; 2) obligate intracellular parasites in eukaryotic cells; 3) multiply within cytoplasmic vacuoles and form cytoplasmic inclusion or microcolony in infected cell, these microcolonies in epithelial cell help to diagnose Chlamydia infections microscopically after staining the smear by Romanowsky–Giemsa; 4) exhibit a complex developmental cycle which includes small, rigid-walled infectious forms (elementary bodies), and larger, non-infectious forms (reticulate bodies, sometimes called initial bodies) which have flexible walls and which divide by fission; 5) the chlamydial cell envelope contains little or no muramic acid; 6) cultured in cell cultures, yolk sacs of chick embryos, and laboratory animals.

Species that carry the greatest medical impact are *Chlamydia trachomatis*, the cause of both a severe eye infection (trachoma) that can lead to blindness and *Chlamydia pneumoniae*, an agent in lung infections.

Two forms of *Chlamydia spp.*:

Elementary body — the form infectious for host cells, a non-dividing, osmotically-stable disseminative cell, ca. 0.2–0.4 μm diam., which has few ribosomes, and in which the condensed nuclear material occupies a major part of the cell; the cell wall proteins are extensively crosslinked by disulphide bonds. Elementary bodies are metabolically limited: glucose is not metabolized, although glucose 6-phosphate and certain other substrates may yield CO_2 if ATP, NADP and other cofactors are also supplied.

Reticulate body — osmotically-labile, trypsin-sensitive cells, ca. 0.6–1.5 μm diam., which contain increased numbers of ribosomes and in which the nuclear material is more diffusely distributed; the disulphide inter-protein cross links in the cell wall are reduced. Reticulate bodies are not infectious for fresh host cells; those of *C. trachomatis* may be capable of glycolysis and of ATP synthesis.

The development cycle of *Chlamydia spp.* The development cycle begins when elementary bodies adhere to unidentified receptor sites on a host cell and undergo cytochalasin D-sensitive

endocytosis. Phagosomes within which elementary bodies are internalized do not fuse with lysosomes. The elementary body subsequently differentiate, becoming reticulate bodies. The reticulate bodies undergo binary fission from 8–10 hours after the initial infection of the host cell, and continue to divide for up to 20 hours after infection. By about 12–15 hours after infection reticulate bodies in endosomes for cytoplasm inclusion or microcolony visible by light microscopy. From 20 hours after infection reticulate bodies begin to give rise to elementary bodies, and by 48–72 hours after infection the cycle is complete — each infected host cell containing 10–1000 elementary bodies in an inclusion which may occupy a major part of the cell. On release, elementary bodies infect fresh host cells. Chlamydiae are typically sensitive to tetracyclines, ketolydes.

Mycoplasmas — are bacteria that naturally lack a cell wall. The mycoplasmas have the trilaminar cytoplasmic membrane stabilized by sterols (e.g. cholestanol or stigmasterol), due to sterols the sell membrane is resistant to lysis. These extremely tiny, pleomorphic cells are considered the smallest cells, ranging from 0.1 to 0.5 μm in size. They range in shape from spherical, ovoid or pear-shaped to branched filamentous forms. Filaments, the typical forms in young cultures under optimum conditions, subsequently transform into chains of coccoid cells which later break up into individual cells that are capable of passing through membrane filters of pore size 0.22 μm or 0.45 μm . Replication of the genome may precede cytoplasmic division; hence, “multi-nucleate” filaments may exist. Most *Mycoplasma* spp are facultatively anaerobic.

They are *not* obligate intracellular parasites and can be grown on artificial complex media, although added sterols (egg yolk) are required for the cell membranes of some species. Colonies (usually < 1 mm diam.) are typically of the ‘fried egg’ type: an opaque, granular central region, embedded in the agar, surrounded by non-granular surface growth. Optimum growth temperature of mammalian strains: 36–37 °C. Many species produce weak or clear haemolysis; haemolysis appears to be due to the secretion of H_2O_2 (a product which is believed to account for some aspects of pathogenicity).

Mycoplasmas are found in many habitats, including plants, soil, and animals. They are parasites and pathogens in the respiratory and urogenital tracts in man and other animals. The most important medical species is *Mycoplasma pneumoniae*, which adheres to the epithelial cells in the lung and causes an atypical form of pneumonia in humans. Mycoplasmas are commonly sensitive to chloramphenicol and to tetracyclines.

Principles of dark-field microscopy (Fig. 4.2). Dark-field microscopy is useful in observing unstained living microorganisms, microorganisms that are difficult to stain, and spirochetes, which are poorly defined by bright-field microscopy, is also used for examining objects too small to be seen by bright-field microscopy.

The compound microscope may be fitted with a darkfield condenser that has a numerical aperture (resolving power) greater than the objective. The underside of the substage condenser is fitted with a central opaque disc (the *stop* or *patch stop*) which allows only the peripheral rays to pass through the condenser — thus forming a hollow cone of light whose apex is focused in the plane of the specimen; in the absence of a specimen these rays diverge at such an angle that none enters the objective so that the field of view appears dark or black. A specimen scatters the rays, some of which enter the objective and form a bright image of the specimen against a dark background.

Principles of phase-contrast microscopy. The phase-contrast microscope permits the observation of invisible living, unstained microorganisms. Certain transparent, colorless living microorganisms and their internal organelles are often impossible to see by ordinary bright-field or dark-field microscopy because they do not absorb, reflect, refract, or diffract sufficient light to contrast with the surrounding environment or the rest of the microorganism. Microorganisms and their organelles are only visible when they absorb, reflect, refract, or diffract more light than their environ-

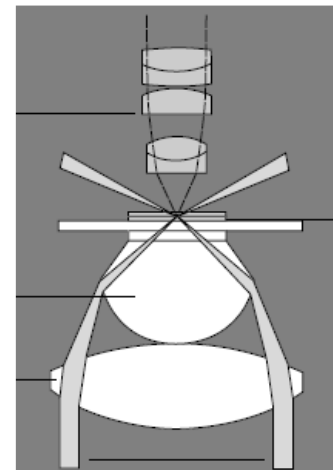

Figure 4.2. Principles of dark-field microscopy

ment. In the phase-contrast microscope, the condenser has an annular diaphragm, which produces a hollow cone of light; the objective has a glass disk (the phase plate) with a thin film of transparent material deposited on it, which accentuates phase changes produced in the specimen. This phase change is observed in the specimen as a difference in light intensity. Phase plate may produce dark-phase-contrast microscopy or bright-phasecontrast microscopy.

Fluorescence microscopy. The fluorescence microscope is a specially modified compound microscope furnished with an ultraviolet (UV) radiation source and a filter that protects the viewer's eye from injury by these dangerous rays. Only several microorganisms displays natural fluorescence (*Vibrio spp.*) and can be seen using this technique. The rest of microorganisms should be stained with certain fluorescent dyes (acridine, fluorescein) or with fluorescent antibodies prior to microscopy. This dyes and fluorescent antibodies emit visible light when bombarded by shorter ultraviolet rays. Subsequent illumination by ultraviolet radiation causes the specimen to give off light that will form an intense yellow, orange, or red image against a black field. Fluorescence microscopy has its most useful applications in diagnosing *Mycobacterium tuberculosis* in sputum. Fluorescent antibodies can be used to detect the causative agents in such diseases as syphilis, chlamydiosis, trichomoniasis, herpes, and influenza.

Class 4. Practical part

Date _____

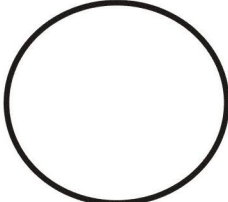
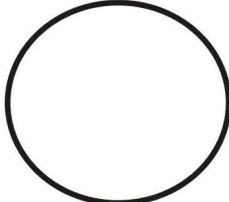
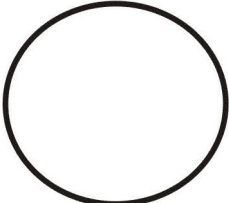
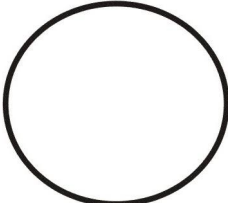
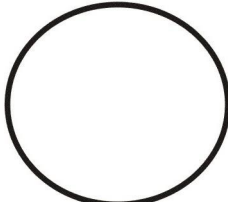
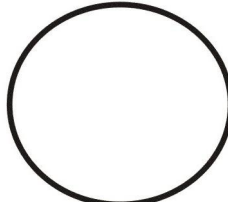
| Laboratory exercises | Laboratory report | |
|--|---|---|
| <p>1. Prepare slide of <i>Rickettsia spp.</i>, stain with fuschin, examine under microscope, complete the report.</p> <p>2. Prepare the hanging-drop slide using motile microorganisms, examine native microorganisms under microscope</p> |  Smear _____ Stain _____ |  Smear _____ Stain _____ |
| <p>Complete the drawings of slides seen in demonstration room:</p> <p>Slide with <i>Treponema denticola</i> in dental plaque, Gram stain.</p> <p><i>Leptospira spp.</i>, dark-field microscopy.</p> <p><i>Borrelia recurrentis</i> in blood of patient with relapsing fever, Romanowsky–Giemsa stain.</p> <p><i>Chlamydia</i> inclusions in cytoplasm of host-cell, Romanowsky–Giemsa stain.</p> <p>Slide with <i>Actinomyces spp.</i>, pure culture, Gram stain.</p> |  Smear _____ Stain _____ |  Smear _____ Stain _____ |
| |  Smear _____ Stain _____ |  Smear _____ Stain _____ |
| Signature of the tutor _____ | | |

Practical class № 5

ANTIMICROBIAL MEASURES. METHODS OF STERILIZATION AND DISINFECTION. ASEPSIS AND ANTISEPSIS. BACTERIOLOGICAL METHOD OF LABORATORY DIAGNOSIS OF INFECTION DISEASES. TECHNIQUES OF MICROBIAL PURE CULTURES ISOLATION AND MAINTENANCE

Suggested reading for self-study. Definition of terms asepsis, sterilization, disinfection, antiseptics. Methods of sterilization: physical, chemical, mechanical. Differences between sterilization and disinfection. Types and methods of disinfection. Practical disinfection. Types and methods of antiseptics. Practical antiseptics. Biocides. Classification of disinfectants. Classification of antiseptics, origin and characteristics of groups. Mechanisms of action on microorganisms. Sterilization, disinfection and antiseptics quality control. Antimicrobial management in hospitals.

Cultivation of microorganisms. Conditions required for growth. Nutrient media for culturing bacteria: classification and characteristics. Culture media ingredients, procedure of preparation and sterilization. General requirements to bacteriologic nutrient media. Incubator.

Bacteriological method of laboratory diagnosis: tasks, procedure, evaluation of the method. Methods of isolation of aerobic and anaerobic microorganisms in pure culture. Streak-plate technique. Bacterial colony characteristics on agar media (form, size, elevation, margin, consistency, surface, texture, density). Cultivation of anaerobic bacteria: culture media, techniques, equipment.

Definition of terms asepsis, sterilization, disinfection, antiseptics.

Microbial control methods involve the use of physical, chemical, biological agents to eliminate or reduce the numbers of microorganisms from a specific environment. Microbial control methods are used to prevent the spread of infectious agents, retard spoilage, and keep commercial products safe.

Biocide is a general term describing a chemical agent, usually broad-spectrum, that inactivates microorganisms. Biocides can be antiseptics, disinfectants, or preservatives. The activity of biocides against microorganisms depends on: 1) the external physical environment; 2) the nature, structure, composition, and condition of the microorganism itself; 3) the ability of the microorganism to degrade or inactivate the biocide.

Sterilization is complete killing, or removal, of all living and in resting (spores) organisms from a particular object or product. It can be accomplished by nondestructive heat treatment, certain gases, exposure to ionizing radiation, some liquid chemicals, and filtration. Disinfection and sterilization makes use of both physical and chemical agents.

Disinfection is the destruction of pathogenic microorganisms on inanimate objects or surfaces in order to prevent transmission of certain microorganisms. Disinfection is usually done with liquid chemical agents known as disinfectants, the most important of which are aldehydes (formaldehyde), alcohols, phenols, halogens (I, Cl), and surfactants (detergents). Bacterial spores, organisms with waxy coats (e.g. mycobacteria), and some viruses may show considerable resistance to the common disinfectants.

Pasteurization is the use of heat at a temperature sufficient to inactivate important pathogenic organisms in liquids such as water or milk but at a temperature below that needed to ensure sterilization. For example, heating milk at a temperature of 74 °C for 3 to 5 seconds or 62 °C for 30 minutes kills the vegetative forms of most pathogenic bacteria that may be present without altering its quality. Pasteurization is a form of disinfection.

Antiseptics — **direct antimicrobial measures** used in or on living tissue (skin, mucus membranes, wounds) to destroy or inhibit vegetative pathogens. Antiseptic measures are usually done with liquid chemical agents known as antiseptics. Antiseptics have lower toxicity than disinfectants used environmentally but are usually less active in killing vegetative organisms.

Sanitization is a less precise term with a meaning somewhere between disinfection and cleanliness. It is used primarily in housekeeping and food preparation contexts.

Preservation is a general term for measures taken to prevent microbe caused spoilage of susceptible products (pharmaceuticals, foods).

Decontamination is the removal or count reduction of microorganisms contaminating an object.

Asepsis — all measures aiming to prevent contamination of objects or wounds protecting from the entry of infectious agents into sterile tissues or media and thus prevents infection or spoilage.

It is applied in many procedures used in the operating room, in the preparation of therapeutic agents, and in technical manipulations in the microbiology laboratory.

Surgical asepsis involves a high level of disinfection, antisepsis, and sterilization as would be required to maintain a microbe-free surgery. Instruments, dressings, sponges, and all other supplies coming into contact with the patient are sterilized. Personnel must be fully covered in sterile garments, and room surfaces and air must be thoroughly disinfected.

Medical asepsis includes any practice that lowers the load of infectious microbes in patients, personnel, and the hospital environment. Included are handwashing, decontamination procedures, and isolation of patients.

Methods of sterilization: physical, chemical, mechanical.

Physical factors used in sterilization.

Expose to a naked flame. This approach is done with the wire loop used in microbiology laboratories. It can be used equally effectively for emergency sterilization of a knife blade or a needle.

Dry heat. Regiments: 180 °C for 1 hour, 160 °C for 2 hours, 120 °C for 4 hours. Equipment: a dry heat sterilizing oven. This method is applicable to metals, glassware, and some heat-resistant oils and waxes that are immiscible in water and cannot, therefore, be sterilized in the autoclave.

Moist heat. This approach is far more rapid and effective in killing all forms of microorganisms than dry heat, because reactive water molecules denature protein irreversibly by disrupting hydrogen bonds between peptide groups at relatively low temperatures. Equipment: an autoclave (a sophisticated pressure cooker). It consists of a chamber in which the air can be replaced with pure saturated steam under pressure. Their effectiveness depends on absence of air, pure saturated steam, and access of steam to the material to be sterilized. Pressure per se plays no role in sterilization other than to ensure the increased temperature of the steam. Regiments: 121 °C — 15 min, 121 °C — 20 min, 121 °C — 30 min, 115 °C — 15 min. “Flash” autoclaves, which are widely used in operating rooms, often use saturated steam at a temperature of 134 °C for 3 minutes.

Autoclaves can thus be used for sterilizing any materials that are not damaged by heat and moisture, such as heat-stable liquids, swabs, most instruments, culture media, and rubber gloves. The spores of *Clostridium botulinum*, the cause of botulism, may survive 5 hours of boiling, but can be killed in 4 minutes at 121 °C in the autoclave.

Quality control of autoclaves depends primarily on ensuring that the appropriate temperature for the pressure used is achieved and that packing and timing are correct. Biological and chemical indicators of the correct conditions are available and are inserted from time to time in the loads.

Nonionizing radiation — ultraviolet (UV) light (wavelength 240–280 nm) is absorbed by nucleic acids and causes genetic damage, including the formation of the thymine dimers. The practical value of UV sterilization is limited by its poor ability to penetrate. Used for irradiation of air in critical hospital sites and in laboratories for decontamination of laboratory facilities. UV light can cause skin and eye damage, and workers exposed to it must be appropriately protected.

Ionizing radiation. It causes direct damage to DNA and produces toxic free radicals and hydrogen peroxide from water within the microbial cells. It has a high ability to penetrate. Two types are used: 1) gamma radiation consisting of electromagnetic waves produced by nuclear disintegration; 2) corpuscular radiation consisting of electrons produced in generators and accelerated to raise their energy level. Radiosterilization equipment is expensive. On a large scale, such systems

are used to sterilize disposable surgical supplies such as gloves, bandages plastic syringes, specimen containers and other plastic medical items, heat-sensitive pharmaceuticals, some foodstuffs.

Chemical factors in sterilization.

Ethylene oxide. It is an inflammable and potentially explosive gas. It is an alkylating agent that inactivates microorganisms by replacing labile hydrogen atoms on hydroxyl, carboxy, or sulfhydryl groups, particularly of guanine and adenine in DNA. Ethylene oxide sterilizers resemble autoclaves and expose the load to 10 % ethylene oxide in carbon dioxide at 50 to 60 °C under controlled conditions of humidity. Exposure times are usually about 4 to 6 hours and must be followed by a prolonged period of aeration to allow the gas to diffuse out of substances that have absorbed it. Aeration is essential, because absorbed gas can cause damage to tissues or skin. Ethylene oxide is a mutagen, and special precautions are now taken to ensure that it is properly vented outside of working spaces. This method is used for sterilization of heat-labile devices such as artificial heart valves or endoscopes.

Formaldehyde vapor. It is an alkylating agent that can be used without pressure to decontaminate larger areas such as rooms.

Oxidizing agents. Hydrogen peroxide, ozone have selective use.

Mechanical sterilization.

Filtration. Microorganisms can be removed from liquids by positive- or negative-pressure filtration. Membrane filters, usually composed of cellulose acetate, with pore size of 0.2 μ m are effective in filtration. Filtration is used for sterilization of large volumes of fluid, especially those containing heat-labile components such as serum or antibiotics. It is not considered effective for removing viruses. Ultrafine filters can absorb viruses and even large molecules.

Disinfection.

Disinfection is the destruction of pathogenic microorganisms on inanimate objects or surfaces in order to prevent transmission of certain microorganisms. Disinfection is usually done with liquid chemical agents known as disinfectants. Bacterial spores, organisms with waxy coats (e.g. mycobacteria), and some viruses may show considerable resistance to the common disinfectants.

Sanitization is any cleansing technique that mechanically reducing the levels of microorganisms so that the possibility of infection or spoilage is greatly decreased. A sanitizer is a compound such as soap or detergent used to perform this task. Examples: air sanitization with ultraviolet lamps reduces airborne microbes in hospital rooms, veterinary clinics, and laboratory installations; dish-washing and other measures in restaurants, dairies, breweries, and other food industries consistently handle large numbers of soiled utensils that could readily become sources of infection and spoilage.

Hospital disinfection and sanitization are important tools in the prevention of cross-infections among hospital patients. Surface disinfection is an important part of hospital hygiene. A combination of cleaning and disinfection is very effective. Suitable agents include aldehyde and phenol derivatives combined with surfactants. Instrument disinfection is used only for instruments that do not cause injuries to skin or mucosa. Laundry disinfection can be done by chemical means or in combination with heat treatment. Final room disinfection is the procedure carried out after hospital care of an infection patient is completed and is applied to a room and all of its furnishings.

Physical disinfection:

Pasteurization — an exposure of liquids to temperatures in the range 55 to 75 °C to remove all vegetative bacteria (but not spores) of significance in human disease. Pasteurization is used commercially to render milk safe and extend its storage quality. With the outbreaks of infection due to contamination with enterohemorrhagic *E. coli*, this has been extended (reluctantly) to fruit drinks.

Uperization — heating to 150 °C for 2.5 seconds in a pressurized container using steam injection.

Sound waves. High-frequency sound (sonic) waves beyond the sensitivity of the human ear are known to disrupt cells. These frequencies range from 15,000 to more than 200,000 cycles per second (supersonic to ultrasonic). Sonication transmits vibrations through a water-filled chamber

(sonicator) to induce pressure changes and create intense points of turbulence that can stress and burst cells. Gram-negative rods are most sensitive to ultrasonic vibration. These procedures cannot be considered sterilization only because the most heat-resistant spores may survive the process.

Chemical disinfection.

Chemical disinfectants cause the death of pathogenic vegetative bacteria. Most of these substances are general protoplasmic poisons. Their activity increases exponentially with increases in temperature it have been established optimal in-use concentration and *exposition time* for all available disinfectants. Chemical disinfectants are classified on the basis of their ability to decontaminate surfaces. High-level disinfectants kill all agents (including spores). Materials that necessitate high-level disinfection are medical devices — for example, catheters, heart-lung equipment, and implants. Intermediate-level disinfectants kill fungal (but not bacterial) spores, resistant pathogens such as the tubercle bacillus, and viruses. Low-level disinfectants eliminate only vegetative bacteria, vegetative fungal cells, and some lipid-enveloped viruses. Disinfectants can be classified according their activity. Bactericide is a chemical that destroys bacteria except for those in the endospore stage. A fungicide is a chemical that can kill fungal spores, hyphae, and yeasts. Avirucide is any chemical known to inactivate viruses. A sporicide (or sterilant) is an agent capable of destroying bacterial endospores.

Group of disinfectants:

1. Alcohol. The alcohols are protein denaturants that rapidly kill vegetative bacteria. Alcohols require water for maximum effectiveness. Solutions of 100 % alcohol dehydrate organisms rapidly but fail to kill, because the lethal process requires water molecules. Ethanol (70–90 %) and isopropyl alcohol (90–95 %) are widely used. They are inactive against bacterial spores, acid-fast *Mycobacterium tuberculosis* and many viruses. Isopropyl alcohol has largely replaced ethanol in hospital use because it is somewhat more active and is not subject to diversion to housestaff parties.

2. Halogens. Chlorine, iodine, and derivatives of these halogens are widely used as disinfectants. Chlorine and iodine show a generalized microbicidal effect and also kill spores.

Chlorine (applied as a 5 % solution called hypochlorite) is a highly effective oxidizing agent that denatures proteins by binding to free amino groups. It reacts rapidly with protein and many other organic compounds. Its activity is lost quickly in the presence of organic material. Chlorine inactivates within seconds most vegetative bacteria and it most viruses. It is used in decontaminating surfaces and glassware, in chlorination supplies of drinking water or water in swimming pools. *Legionella pneumophila* may resist to the usual concentrations of chlorine.

Iodine (tincture of 2 % iodine in 50 % alcohol) acts by iodinating or oxidizing essential components of the microbial cell. This preparation stains materials with which it comes into contact. Tincture of iodine has now been largely replaced by iodophors — preparations in which iodine is combined with carriers (povidone) or nonionic detergents. Iodophors gradually release small amounts of iodine. They cause less skin staining and dehydration than tinctures and are widely used in preparation of skin before surgery.

3. Oxidants. This group includes ozone, hydrogen peroxide, potassium permanganate, and peracetic acid. Their relevant chemical activity is based on the splitting off of oxygen. Most are used as mild antiseptics to decontaminate mucosa, skin, or wounds. **Hydrogen peroxide** is a powerful oxidizing agent that attacks membrane lipids and other cell components. It has been useful in decontamination of materials that are not susceptible to corrosive effect (example: contact lenses).

4. Surface-active compounds (syn. surfactants, tensides, detergents). Surfactants include anionic, cationic, amphoteric, and nonionic detergents. Cationic and amphoteric types are the most effective. They have no effect at all on tuberculosis bacteria (with the exception of amphotensides), spores, or nonencapsulated viruses. Their advantages include low toxicity levels, lack of odor, good skin tolerance, and a cleaning effect. They have hydrophobic and hydrophilic groups that attach to and solubilize various compounds or alter their properties.

Anionic detergents (soaps). They display cleaning effect but little direct antibacterial effect, because their charge is similar to that of most microorganisms.

Cationic detergents (quaternary ammonium compounds (“quats”), such as benzalkonium chloride, Zephiran, cetylpyridinium chloride). Quats are highly bactericidal in the absence of contaminating organic matter. Their hydrophobic and lipophilic groups react with the lipid of the cell membrane of the bacteria, alter the membrane’s surface properties and its permeability, and lead to loss of essential cell components and death. The antibacterial effect of quaternary ammonium compounds is inactivated by soap. They are inactive against spores and most viruses. *Pseudomonas aeruginosa* can grow in the “quat” solutions and then cause hospital infections.

5. Phenol and phenolics. Phenol (carbolic acid) was the primary agent employed by Lister in his antiseptic surgical procedure. Phenol is highly toxic and solution of phenol is now used only in certain limited cases (throat washes), but it remains one standard against which other disinfectants are rated. Substances chemically related to phenol are often referred to as phenolics. Phenols denature proteins and display bactericidal effect. They used as effective environmental decontaminants in hospital hygiene. Phenolics consist of one or more aromatic carbon rings with added functional groups (alkylated, arylated, and halogenated phenols). Among the most important are alkylated phenols (cresols), chlorinated phenols, and bisphenols (hexachlorophene).

Biguanides (chlorhexidine). Chlorhexidine (Hibiclens, Hibitane) is a complex organic base containing chlorine and two phenolic rings; acts as surfactant and a protein denaturant. It alters membrane permeability of both Gram-positive and -negative bacteria. It is cationic and, thus, its action is neutralized by soaps and anionic detergents. They are the active ingredient in many mouthwash, handwash and sore throat preparations. Mycobacteria are generally highly resistant.

Bisphenols (orthophenyl, hexachlorophene, triclosan). Orthophenyl is the major ingredient in disinfectant aerosol sprays. Hexachlorophene and triclosan are widely used in antiseptic soaps and hand rinses. They have little activity against *Pseudomonas aeruginosa* and molds.

6. Aldehydes (glutaraldehyde and formaldehyde) They are alkylating agents causing protein denaturation that is why highly lethal to essentially all microorganisms.

Glutaraldehyde is used for low-temperature disinfection and sterilization of endoscopes and lensed surgical equipment. It is normally used as a 2 % solution to achieve sporicidal activity.

Formaldehyde is a broad-spectrum germicide for bacteria, fungi, and viruses. Formaldehyde gas is used in a special apparatus for gas sterilization. Formalin is a 35 % solution of formaldehyde gas in water. Formaldehyde irritates mucosa; skin contact may result in inflammations or allergic eczemas. formaldehyde is based on.

7. Heavy metal derivatives (silver sulfadiazine, silver nitrate). Mercury, silver, and most other metals exert microbicidal effects by binding onto functional groups, including sulfhydryls, hydroxyls, amines, and phosphates. This binding inactivates proteins, DNA and rapidly brings metabolism to a standstill.

8. Organic acids. Organic acids are used as preservatives in the pharmaceutical and food industries. Benzoic acid is fungistatic; propionic acid is both bacteriostatic and fungistatic.

Choosing a microbicidal chemical. A biocide should display following properties: 1) rapid action even in low concentrations; 2) solubility in water or alcohol and long-term stability, 3) broad-spectrum microbicidal action without being toxic to human and animal tissues, 4) penetration of inanimate surfaces to sustain a cumulative or persistent action; 5) resistance to becoming inactivated by organic matter; 6) noncorrosive or nonstaining properties; 7) sanitizing and deodorizing properties; 8) inexpensiveness and ready availability.

No chemical can completely fulfill all of those requirements, but glutaraldehyde and hydrogen peroxide approach this ideal.

The following additional factors influence the action of antimicrobial agents: 1) the number of microorganisms; 2) the nature of the microorganisms in the population; 3) the temperature and pH of the environment; 4) the concentration (dosage, intensity) of the agent; 5) the mode of action of the agent; 6) the presence of solvents, interfering organic matter, and inhibitors.

Antisepsis — direct antimicrobial measures used in or on living tissue (skin, mucus membranes, wounds) to destroy or inhibit vegetative pathogens. Antiseptic measures are usually done with liquid chemical agents known as antiseptics.

Antisepsis divided into therapeutic and preventive. **Therapeutic antisepsis** is used for treatment purulent wound or infected mucus membranes. Examples: antisepsis of purulent wounds, antisepsis of throat during pharyngitis or tonsillitis, usage of nalidixic acid for treatment of cystitis. **Preventive antisepsis** includes measures that protect from the development of infection. Examples: preparing the skin before surgical incisions with iodine compounds, swabbing an open root canal with hydrogen peroxide, ordinary hygienic handwashing with a germicidal soap, surgical hands antisepsis, application of sulfacylum-natrium in newborn for the prevention of conjunctivitis caused by *Neisseria gonorrhoeae* or *Chlamydia trachomatis*, treatment of umbilical's wound in newborn for the prevention of sepsis, antisepsis of fresh wound with hydrogen peroxide.

Antisepsis of fresh wound includes:

Washing with soap (this step eliminates mud, blood from wound);

Surgical treatment (eliminates necrotized or dead tissues);

Treatment with antiseptics (prophylaxis of purulent inflammation);

Isolation with sterile bandages.

According to factors used antisepsis can be classified for the physical, chemical, biological. Physical antisepsis uses ultrasound, UV light, laser, draining of wounds, sorption. Chemical antisepsis is widely used and usually done with liquid chemical agents known as antiseptics. Biological antisepsis applies phages (viruses of bacteria).

Antiseptics are usually the same compounds as disinfectants taken in a reduced concentrations that is why they are less toxic but less effective in killing of microorganisms.

Modes of action of disinfectants and antiseptics:

1. Damage to DNA. Ionizing radiations, ultraviolet light, and DNA-reactive chemicals (alkylating agents and other compounds). Acridine derivatives bind to DNA to prevent its replication and function (transcription).

2. Protein denaturation (heat, alcohols, phenols, aldehydes, heavy metals, oxidants). Proteins exist in a folded, three-dimensional state determined by intramolecular covalent disulfide linkages and a number of noncovalent linkages such as ionic, hydrophobic, and hydrogen bonds. Tertiary structure of proteins is readily disrupted by a number of physical or chemical agents, causing the protein to become nonfunctional.

3. Disruption of cell membrane or wall. Substances that concentrate at the cell surface may alter the physical and chemical properties of the membrane, preventing its normal functions and therefore killing or inhibiting the cell. Surfactant compounds (amphoteric and cationic) attack the cytoplasmic membrane.

4. Removal of free sulfhydryl groups. Enzyme proteins containing cysteine have sulfhydryl groups. Oxidizing agents and metals thus interfere with metabolism by forming disulfide linkages between neighboring sulfhydryl groups.

Antimicrobial management in hospitals.

Infectious diseases acquired as a result of a hospital stay are known as nosocomial infections. The rate of nosocomial infections can be as low as 0.1 % or as high as 20 % of all admitted patients depending on the clinical setting, with an average of about 5 % (about 2–4 million cases a year, which result in 20,000 to 40,000 deaths). The hospital both attracts and creates compromised patients, and it serves as a collection point for pathogens. Some patients become infected when surgical procedures or lowered defenses permit resident flora to invade their bodies. Other patients acquire infections directly or indirectly from medical equipment, other patients, medical personnel, visitors, air, and water.

Treatments using reusable instruments such as respirators and thermometers constitute a possible source of infectious agents. Catheters, drainage tubes, and tracheostomy tubes form a ready portal of entry and habitat for infectious agents. An additional problem is the tendency for drug-resistant strains of microorganisms to develop in hospitals, thereby further complicating treatment.

The most common nosocomial infections involve the urinary tract, the respiratory tract, and surgical incisions. The most often nosocomial pathogens are *Escherichia coli*, *Klebsiella*, *Pseudomonas*, staphylococci and streptococci. The potential seriousness and impact of nosocomial infections have required hospitals to develop committees that monitor infectious outbreaks and develop guidelines for infection control and aseptic procedures.

Cultivation of microorganisms. Conditions required for growth. Nutrient media for culturing bacteria: classification and characteristics. Culture media ingredients, procedure of preparation and sterilization. General requirements to bacteriologic nutrient media. Incubator.

A major stimulus to the rise of microbiology 100 years ago was the development of techniques for growing microbes out of their natural habitats and in pure form in the laboratory. This milestone enabled the close examination of a microbe and its morphology, physiology, and genetics. At least 500 different types of media are used in culturing and identifying microorganisms.

Medium — any liquid or solid preparation made specifically for the growth, storage or transport of microorganisms or other types of cell.

Inoculation — the introduction of live cells into liquid sterile media or onto the surface of solidified media is called.

Culture (n) — a population of bacterial cells growing on/in culture media.

Culture (v) — proliferation of bacteria with a suitable nutrient substrate.

Pure culture — a population of genetically homogeneous microorganisms (cells belong to the same strain of the same species). Study of bacteria usually requires pure cultures isolation.

Colony — visible growth of individual cells deposited across the surface of solidified medium. The cells in a colony are usually descended from a single original cell. Colonies of different species and strains show marked differences in size, form, consistency, elevation, margin, surface texture (smooth, rough), density (translucent, opaque). Colonies of organisms possessing large polysaccharide capsules are usually mucoid. Differences in colonial morphology are very useful for separating bacteria in mixtures and as clues to their identity.

The growth rate of a bacterial culture depends on three factors: 1) the species of bacteria; 2) the chemical composition of the medium and atmosphere; 3) the temperature.

The growth rate and the species of bacteria. The time required for a complete fission cycle — from parent cell to two new daughter cells — is called the generation, or doubling, time. The average generation time in majority of bacteria is 30 to 60 minutes under optimum conditions. That is why 24 h is usually enough to get visible growth on/in media. *Mycobacterium tuberculosis* has a generation time of 24 h, *Mycobacterium leprae* 10 to 30 days as long as in some animals. That is why visible growth of *Mycobacterium tuberculosis* on media appears in 2–3 months.

Temperature. Different microbial species vary widely in their optimal temperature ranges for growth: **Psychrophilic** forms grow best at low temperatures (15–20 °C); **mesophilic** forms grow best at 30–37 °C; and most **thermophilic** forms grow best at 50–60 °C. Most pathogens of warm-blooded creatures have a temperature optimum for growth near normal body temperature, 37 °C, therefore, incubators set at 35 to 37 °C are used for culture of most clinical specimens.

Atmosphere. Many organisms are obligate aerobes, specifically requiring oxygen as hydrogen acceptor; some are facultative, able to live aerobically or anaerobically; and others are obligate anaerobes, requiring a substance other than oxygen as hydrogen acceptor and being sensitive to oxygen inhibition (Table 5.1).

Growth in fluid media state (broths) is apparent when bacterial numbers are sufficient to produce turbidity or macroscopic clumps. Turbidity results from reflection of transmitted light by the bacteria; depending on the size of the organism, more than 10^6 bacteria per milliliter of broth are

usually required. Most bacteria grow diffusely, but strictly aerobic bacteria may grow as a film on the surface of the broth, and other bacteria grow as a sediment.

Table 5.1

Classification of bacteria by oxygen resistance and their ability to use molecular oxygen as a final acceptor

| Type of bacteria | Oxygen resistance | | Example |
|-------------------------------------|---|---|---|
| Aerobe (strict aerobe) | Requires O ₂ | Respiration | <i>Mycobacterium tuberculosis</i> <i>Pseudomonas aeruginosa</i> |
| Facultative anaerobe | Grows with or without O ₂ | Respiration in O ₂ atmosphere or fermentation in absence of O ₂ | <i>Escherichia coli</i> <i>Shigella spp.</i> <i>Salmonella spp.</i> <i>Staphylococcus spp.</i> |
| Microaerophilic | Grow at low O ₂ (< 5 %) or without O ₂ | Respiration or fermentation | <i>Campylobacter jejuni</i> |
| Aerotolerant anaerobe | Grow in the presence of O ₂ without using it as electron and proton acceptor | Fermentation | |
| Obligate anaerobe (strict anaerobe) | Killed by O ₂ | Fermentation | <i>Clostridium botulinum</i> <i>Bacteroides melaninogenicus</i> |

Composition of bacteriological media, classification.

Most of the dry weight of microorganisms is organic matter containing the elements carbon, hydrogen, nitrogen, oxygen, phosphorus, and sulfur. In addition, inorganic ions such as potassium, sodium, iron, magnesium, calcium, and chloride are required to facilitate enzymatic catalysis and to maintain chemical gradients across the cell membrane. In order to grow, an organism requires all of the elements in its organic matter and the full complement of ions required for energetics and catalysis. Microorganisms vary widely in their nutritional demands and their sources of metabolic energy.

General requirements to bacteriologic nutrient media. A nutrient medium in which chemoorganotrophs are to be cultivated must:

meet the growth demands of microorganism of interest and contain;

organic energy sources;

sources of carbon and nitrogen;

other macronutrients (sulfur, phosphorus, calcium, magnesium etc.);

micronutrients (trace elements as enzyme activators);

growth factors (organic compounds necessary for synthesis of specific bacterial compounds);

be transparent (for broth media) to inspect the growth of microorganisms;

be sterile that is obligatory for isolation of pure cultures;

have certain pH and display buffer properties to neutralize acid metabolites of growing bacteria. Most organisms have a fairly narrow optimal pH range. The optimal pH must be empirically determined for each species. Most organisms (**neutralophiles**) grow best at a pH of 6.0–8.0, although some forms (**acidophiles**) have optima as low as pH 3.0 and others (**alkaliphiles**) have optima as high as pH 9;

be isotonic (to have an appropriate osmotic pressure);

be reduced and contain O₂ as little as 0,1 % (for anaerobes; O₂ toxic for them);

have enough H₂O for diffusion of nutrients inside cytoplasm.

Media are extremely varied in nutrient content and consistency. Media can be classified on four primary levels: 1) physical form; 2) chemical composition; 3) functional type; 4) purpose in laboratory diagnosis of infection diseases.

According to physical form media can be solid, semi-solid, liquid.

Liquid media. They are water-based solutions that do not solidify at temperatures above freezing and that tend to flow freely when the container is tilted. Examples: broths, milks, or infusions. They are made by dissolving various solutes in distilled water. A common laboratory medium, nutrient broth, contains beef extract and peptone dissolved in water. Methylene blue milk and litmus milk are opaque liquids containing whole milk and dyes. Growth in this media can be dispersed, cloudy or particulate.

Semisolid media. Media with a clotlike consistency because they contain up to 0.5–0.7 % of solidifying agent (agar or gelatin) that thickens them but does not produce a firm substrate. Semisolid media are used to determine the motility of bacteria. Examples: thioglycollate medium is a slightly viscous broth used for determining patterns of growth in oxygen.

Solid media. Media with firm surface on which cells can form discrete colonies. They are widely used for isolating and subculturing bacteria and fungi. These media contain agar or gelatin from 1 % to 5 %. Example: nutrient agar contains beef extract and peptone, as well as 1.5 % agar by weight.

Agar. It is solid at room temperature, and it melts (liquefies) at the boiling temperature of water (100 °C). Once liquefied, agar does not resolidify until it cools to 42 °C. Agar is flexible and it is not itself a digestible nutrient for most microorganisms.

According to chemical composition media can be:

Natural media — media cooked from plant animal products (meat, milk, carrots, plums, potatoes, blood serum etc.), this media are not standard and they are used as enrichment supplements to non-synthetic media.

Synthetic media — media in which all the constituents (including trace substances) are precisely quantitatively and chemically known. Such media contain pure organic and inorganic compounds (in monomer forms, usually of low molecular weight) and have a molecular content specified by means of an exact formula. Such standardized and reproducible media are most useful in research and cell culture when the exact nutritional needs of the test organisms are known. Example: minimal media for fungi contain nothing more than a few essential compounds such as salts and amino acids dissolved in water. Defined medium. One.

Complex, or nonsynthetic, media. They contain at least one ingredient that is not chemically definable — not a simple, pure compound and not representable by an exact chemical formula. They contain mixture of complex nutrients: extracts of animals, plants, or yeasts, including such materials as ground-up cells, tissues, and secretions. Examples of ingredients of nonsynthetic media: meat extracts or infusions, yeast extract, soybean digests, peptone. Peptone is a partially digested protein, rich in amino acids, that is often used as a carbon and nitrogen source. Examples of media: nutrient broth and agar, blood agar base, Columbia agar, MacConkey agar. This type of media is widely used in bacteriology.

According to functional type media can be classified as follows:

General-purpose media (or nutrient media). Media containing a mixture of nutrients that could support the growth of various nutritionally undemanding species of bacteria. They are designed to permit isolation and propagation of microorganisms. As a rule, they are nonsynthetic. These media are prepared with enzymatic or acid digests of animal or plant products. The digest reduces the native protein to a mixture of polypeptides and amino acids that also includes trace metals, coenzymes, and various undefined growth factors. Examples: nutrient agar and broth, brain-heart infusion, trypticase soy agar (TSA). TSA contains partially digested milk protein (casein), soybean digest, NaCl, and agar.

Enriched media — any (liquid or solid) basal media which have been supplemented (enriched) with serum or blood or with any of a range of nutrients or growth factors — in order to enable it to support or enhance the growth of nutritionally demanding species (fastidious) of bacteria. An enriched medium contains complex organic substances such as blood, serum, hemoglobin, or special growth factors (specific vitamins, amino acids) that certain species must have in order to grow. Examples: anaerobe blood agar, serum nutrient agar, chocolate agar etc.

Selective media. Selective media are used for isolation of specific pathogenic organisms from polymicrobial specimens. They can permit, in a single step, the preliminary identification of a genus or even a species (e.g. *Salmonella* spp. in stool specimen). A selective medium contains one or more agents that suppress the unwanted background organisms and favoring growth of the desired ones for isolation of a specific type of microorganism from samples containing dozens of different species — for example, feces, saliva, skin, water, and soil. Selective media usually contain dyes, other chemical additives, or antimicrobics at concentrations designed to inhibit contaminating flora but not the suspected pathogen. Examples: mannitol salt agar contains a concentration of NaCl (7.5 %) that is quite inhibitory to most human pathogens except the genus *Staphylococcus*, which grows well in this medium and consequently can be amplified in very mixed samples. Bile salts, a component of feces, inhibit most gram-positive bacteria while permitting many gram-negative rods to grow. Dyes such as methylene blue and crystal violet also inhibit certain gram-positive bacteria.

Differential medium. A solid medium on/in which different types of organism may be distinguished by their different forms of growth (MacConkey's agar). Usually these media contain sugar(s), indicator pH and selective agent (dyes, antimicrobics). Example: MacConkey agar contains neutral red, a dye that is pink or red when neutral and yellow when acidic. A common intestinal bacterium such as *Escherichia coli* that gives off acid when it metabolizes the lactose in the medium develops red to pink colonies, and one like *Salmonella* that does not give off acid remains its natural color (off-white).

Indicator media. Indicator media contain one or more carbohydrates (or aminoacids) and a pH indicator. They allow to determine biochemical properties of pure cultures. A color change indicates the presence of acid (base) products and thus of fermentation or oxidation of the carbohydrate (aminoacid) by the organism.

Reducing media. These media are important for growing anaerobic bacteria as they have low concentration of O₂ due to the presence of rich for SH-groups reducing agents (cystein, *thioglycolate* Na) neutralizing O₂.

According to purpose in laboratory diagnosis of infection diseases media can be:

Transport media. Transport media are used to maintain and preserve specimens that have to be held for a period of time before clinical analysis or to sustain delicate species that die rapidly if not held under stable conditions. Stuart's and Amies transport media contain salts, buffers, and absorbants to prevent cell destruction by enzymes, pH changes, and toxic substances, but will not support growth.

Enrichment media — any broth medium used for enrichment; it may contain substance(s) which encourage growth of the required organism and inhibit the growth of other type(s) of organism (selenite broth for *Salmonella*).

Media for pure culture isolation.

Media for pure culture identification.

Maintenance media. Used for the initial growth and subsequent storage (under conditions of minimal growth) of microorganisms or other cells. For microorganisms, a maintenance medium is used to prepare a culture of the given organism which is then stored either at room temperature or under refrigeration; subculture is required at intervals ranging from 1 to 12 months.

Bacteriological method refers as the method based on pure culture isolation using bacteriological media and identification of pure culture by detection of morphological, biochemical, antigenic, genetic, biological properties of isolated pure culture. Or it the method of five I's — inoculation, incubation, isolation, inspection, and identification.

Growth and identification of the infecting agent in vitro is usually the most sensitive and specific means of diagnosis and is thus the method most commonly used. Most bacteria and fungi can be grown in a variety of artificial media, but strict intracellular microorganisms (e.g. *Chlamydia*, *Rickettsia*, and human and animal viruses) can be isolated only in cultures of living eukaryotic cells.

Step 1 (First day).

Preliminary analytical step. The diagnosis of a microbial infection begins with an assessment of clinical and epidemiologic features, leading to the formulation of a diagnostic hypothesis. Anatomic localization of the infection with the aid of physical and radiologic findings is usually included. This clinical diagnosis suggests a number of possible etiologic agents based on knowledge of infectious syndromes and their courses.

The clinician must select the appropriate tests and specimens to be processed and, where appropriate, suggest the suspected etiologic agents to the laboratory. The laboratory worker must use those methods that will demonstrate the probable agents, and be prepared to explore other possibilities suggested by the clinical situation or findings of the laboratory examinations. The best results are obtained when communication between the clinic and laboratory is maximal.

Specimen collection (sampling) and transportation.

It is very important that the material to be tested be correctly obtained (sampled) and transported. In general, material from which the pathogen is to be isolated should be sampled as early as possible before chemotherapy is begun. Transport to the laboratory must be carried out in special containers, usually containing transport media. An invoice must be attached to the material containing the information required for processing (using the form provided). If the specimen is not appropriately chosen and/or collected, there will be a failure in establishing an etiologic diagnosis. Clinical specimens for determining the cause of an infectious disease are obtained from body fluids (blood, cerebrospinal fluid), discharges (sputum, urine, feces), or diseased tissue. Other samples subject to microbiological analysis are soil, water, sewage, foods, air, and inanimate objects.

Isolation and incubation. After arrival to a laboratory native preparations (with or without vital staining) or stained preparations of specimens are examined under a microscope. Microscopy allows evaluating amount and types of microorganisms present in the samples. Almost all medically important bacteria can be cultivated outside the host in artificial culture media. After microscopy specimen is inoculated on solid media (selective and differential media are preferred) using single colony isolating technique. Certain isolation techniques are based on the concept that if an individual bacterial cell is separated from other cells and provided adequate space on a nutrient surface, it will grow into a discrete mound of cells called a colony. Because it was formed from a single cell, a colony consists of just that one species and no other. Proper isolation requires that a small number of cells be inoculated into a relatively large volume or over an expansive area of medium. In the streak plate method, a small droplet of culture or sample is spread over the surface of the medium according to a pattern that gradually thins out the sample and separates the cells spatially over several sections of the plate (figure). Once a container of medium has been inoculated, it is incubated in a temperature-controlled chamber or incubator to encourage multiplication. Although microbes have adapted to growth at temperatures ranging from freezing to boiling, the usual temperatures used in laboratory propagation fall between 20 °C and 40 °C. Usually microorganisms are incubated at 37 °C — 24 hours. During the incubation period (ranging from a day to several weeks), the microbe multiplies and produces growth that is observable macroscopically. Majority of organisms forms visible colonies within 18–24 hours except *Mycobacterium tuberculosis* that require 2–3 months, *Brucella* and some *Actinomyces* — 14 days, anaerobes — 48 hours. Incubators can also

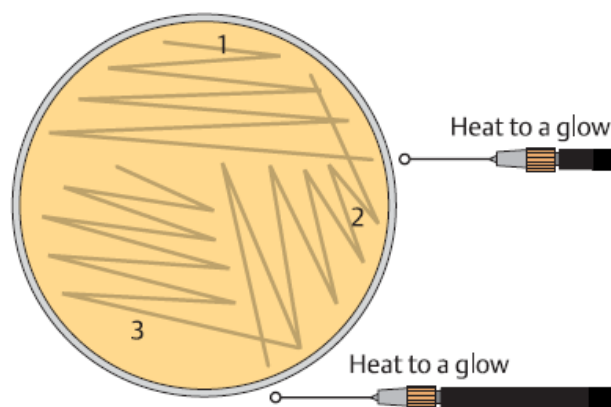

Figure 5.1. Isolated colonies are obtained by means of fractionated inoculation of nutrient agar

control the content of atmospheric gases such as oxygen and carbon dioxide that may be required for the growth of certain microbes.

Second day. Inspection and subculture. During inspection, the cultures are examined and evaluated macroscopically and microscopically. For diagnostic work, growth of bacteria on solid media has advantages over the use of broth cultures. It allows isolation of bacteria in pure culture, because a colony well separated from others can be assumed to arise from a single organism or an organism cluster (colony-forming unit). All types of isolated colonies are gram-stained and examined under microscope to estimate morphology of isolates. After that the isolated colonies are subcultured on slant media to accumulate biomass for further investigations. Inoculated media are incubated at 37 °C — 24 hours.

Third day. Identification of bacteria. The subcultures are gram-stained to confirm their purity and exclude contamination or mixed cultures as only pure cultures is processed in clinical bacteriology. A mixed culture is a mixture of two or more easily differentiated species of microorganisms. A contaminated culture was once pure but has since had contaminants (unwanted microbes of uncertain identity) introduced into it. Identification of pathogens is based on detection their biochemical, antigenic, genetic, biological (toxin production, susceptibility to phages) properties, chemical composition. Usually it takes 24 hours to determine biochemical properties. In parallel antibiotic susceptibility is detected for isolated pure cultures.

Fourth day. Analysis of results and formulation of report on ethiology and antimicrobial susceptibility of causative agents of infections.

As pure cultures, biological samples constitute a potential hazard they require immediate and proper disposal using steam sterilizing or other methods of sterilization. On the other hand, many teaching and research laboratories maintain a line of stock cultures that represent “living catalogues” for study and experimentation. The largest culture collection can be found at the American Type Culture Collection in Rockville, Maryland, which maintains a voluminous array of frozen and freeze-dried fungal, bacterial, viral, and algal cultures.

Estimation of the method. It is sensitive enough and allows detecting microorganisms present in concentration as low as 10^3 CFU/ml. It is specific as permit identification of majority of microorganisms and considered to be “the golden standard” in diagnosis of infection diseases. *Uncultured* microorganisms can not be detected this way.

Culturing anaerobes

An oxygen-free environment for the growth of anaerobic microorganisms is achieved by application of the **GasPak Anaerobic System** (Fig. 5.2). Inoculated plates or tubes are placed inside the chamber, and anaerobic conditions are created by adding water to a **gas generator envelope** that is placed in the jar just before sealing. The envelope contains chemical tablets, **sodium borohydride, boric acid, sodium bicarbonate and sodium hydrocarbonat**. Water reacts with these chemicals, producing **hydrogen gas** and **carbon dioxide**. The hydrogen gas combines with free oxygen in the chamber to produce water, removing all free oxygen from the chamber. This reaction is catalyzed by the element **palladium**, which is attached to the underside of the lid of the jar. The **carbon dioxide** is necessary as anaerobes belong to coprophilic microorganisms.

Anaerobic media. In addition to meeting atmospheric requirements, isolation of strictly anaerobic bacteria requires usage enriched and reduced media as anaerobes belong to fastidious microorganisms dying in the presence of oxygen. Media for anerobes are enriched by addition sheep blood (5 %), vitamin enrichment (vitamin K), and hemin. Proper reduction is achieved by addition L-cysteine and/or sodium thioglycolate. Plate media are made selective for anaerobes by the addition of aminoglycoside antibiotics, which are active against many aerobic and facultative organisms but not against anaerobic bacteria. The use of selective media is particularly important with anaerobes because they grow slowly and are commonly mixed with facultative bacteria in infections.

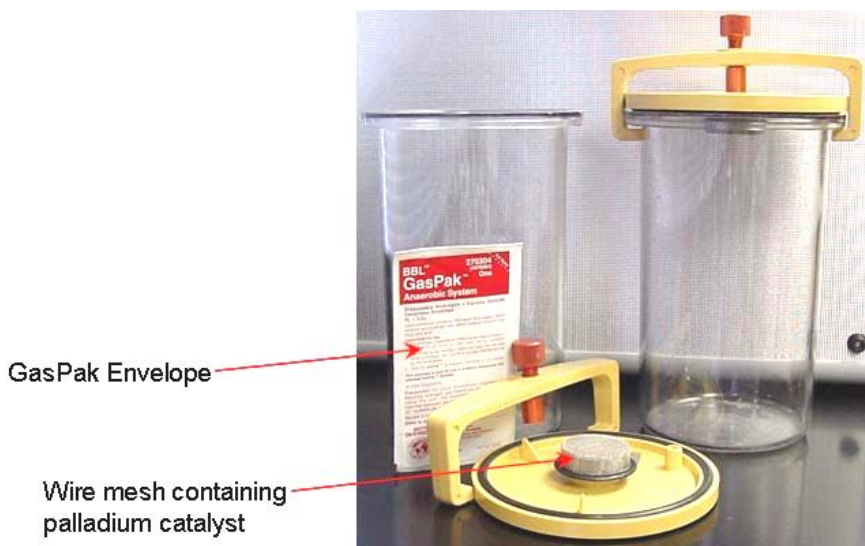

Figure 5.2. GasPak Anaerobic System

Class 5. Practical part

Date _____

| Laboratory exercises | Laboratory report | | | | | | | | | | | | | | | | | | | | | | | | | | | | | | | | | | | | | | | | | | | | |
|--|---|--------------|---------------|----------------|-----------------------|-----------------------|--|--|---------|---------|---|----|----|--|--|--|--|--|--|--|--|--|--|--|--|--|--|--|--|--|--|--|--|--|--|--|--|--|--|--|--|--|--|--|--|
| <p>Experiment 1. Study the activity of some disinfectants and learn the importance of time, germicidal concentration, and microbial species in disinfection. Complete the report and formulate a conclusion</p> | <p>Procedure:</p> <ol style="list-style-type: none"> Pipette 5.0 ml of the disinfectant solution into a sterile test tube. To the 5 ml of disinfectant, add 0.5 ml of the <i>E. coli</i> culture. Gently shake the tube to distribute the organisms uniformly. Note the time. Divide a nutrient agar plate into four sections with a marking pen or pencil. At intervals of 2, 5, 10, and 15 minutes, transfer one loopful of the disinfectant-culture mixture to a section of the nutrient agar plate. Label each plate with the name of the organism, the disinfectant, and its concentration (e.g., <i>E. coli</i>, 1 % phenol). Label each section of the plate with the time of exposure (e.g., 2 minutes, 5 minutes, etc.). Using the same concentration of the same disinfectant, repeat steps 1 to 3 with the culture of <i>B. subtilis</i>. Inoculate one-half of a nutrient agar plate directly from the <i>E. coli</i> culture and the other half from the <i>B. subtilis</i> culture. Label each half with the name of the organism and the word Control. Incubate all tubes at 35 °C for 48 hours. <p>Results. Observe all plate sections for growth (+) or absence of growth (-). Complete the table by recording your own results with each disinfectant.</p> <p>Results</p> <table border="1" data-bbox="464 1624 1423 1877"> <thead> <tr> <th rowspan="2">Disinfectant</th> <th rowspan="2">Concentration</th> <th rowspan="2">Micro-organism</th> <th colspan="4">Time of exposure, min</th> <th rowspan="2">Control</th> </tr> <tr> <th>2</th> <th>5</th> <th>10</th> <th>15</th> </tr> </thead> <tbody> <tr> <td></td> <td></td> <td></td> <td></td> <td></td> <td></td> <td></td> <td></td> </tr> <tr> <td></td> <td></td> <td></td> <td></td> <td></td> <td></td> <td></td> <td></td> </tr> <tr> <td></td> <td></td> <td></td> <td></td> <td></td> <td></td> <td></td> <td></td> </tr> <tr> <td></td> <td></td> <td></td> <td></td> <td></td> <td></td> <td></td> <td></td> </tr> </tbody> </table> <p>Conclusion: _____</p> <p>_____</p> <p>_____</p> <p>_____</p> | Disinfectant | Concentration | Micro-organism | Time of exposure, min | | | | Control | 2 | 5 | 10 | 15 | | | | | | | | | | | | | | | | | | | | | | | | | | | | | | | | |
| Disinfectant | Concentration | | | | Micro-organism | Time of exposure, min | | | | Control | | | | | | | | | | | | | | | | | | | | | | | | | | | | | | | | | | | |
| | | 2 | 5 | 10 | | 15 | | | | | | | | | | | | | | | | | | | | | | | | | | | | | | | | | | | | | | | |
| | | | | | | | | | | | | | | | | | | | | | | | | | | | | | | | | | | | | | | | | | | | | | |
| | | | | | | | | | | | | | | | | | | | | | | | | | | | | | | | | | | | | | | | | | | | | | |
| | | | | | | | | | | | | | | | | | | | | | | | | | | | | | | | | | | | | | | | | | | | | | |
| | | | | | | | | | | | | | | | | | | | | | | | | | | | | | | | | | | | | | | | | | | | | | |

| Laboratory exercises | Laboratory report | | | | | | | | | | | | | | | |
|---|--|-----------------|------------------------|-----------------|---|---------|--|---|--|--|---|--------------------------|--|---|--------------------------------------|--|
| <p>Experiment 2. Test the effectiveness of hygienic and surgical hand antisepsis</p> | <ol style="list-style-type: none"> 1. Divide a nutrient agar plate into four sections with a marking pen or pencil. Label each section of the plate with numbers N 1, 2, 3, 4. 2. Label each plate with your group number and your name. 3. On the surface of agar medium at section N 1 make a fingerprint of skin untreated with any antiseptic (control). 4. Wash your hands with soap as you do it usually at home and make a fingerprint on the surface the agar medium at section N 2. 5. Wash your hands with soap twice and treat the fingers with antiseptic (1 % solution of iodopyron) — 2 minutes, neutralize iodopyron with neutralizer (1 % solution of sodium thiosulfate) for 2 minutes and make a fingerprint on the surface of agar medium at section N 3. 6. Do not wash your hands and treat the fingers with antiseptic (1 % solution of iodopyron) — 2 minutes, neutralize iodopyron with neutralizer (1 % solution of sodium thiosulfate) for 2 minutes and make a fingerprint on the surface of agar medium at section N 4. 7. Incubate Petri dishes at 37 °C for 24 hours. 8. After incubation count the amount of colonies grown at each section and fill in the table. Formulate the conclusion regarding effectiveness of hygienic and surgical hand antisepsis <table border="1" data-bbox="469 904 1437 1084"> <thead> <tr> <th>Section</th> <th>Experiment description</th> <th>Quantity of CFU</th> </tr> </thead> <tbody> <tr> <td>1</td> <td>Control</td> <td></td> </tr> <tr> <td>2</td> <td>Hygienic hand antisepsis (washing with soap)</td> <td></td> </tr> <tr> <td>3</td> <td>Surgical hand antisepsis</td> <td></td> </tr> <tr> <td>4</td> <td>Antisepsis with antiseptic iodopyron</td> <td></td> </tr> </tbody> </table> <p>Conclusion _____</p> <p>_____</p> <p>_____</p> <p>Question for discussion:</p> <ol style="list-style-type: none"> 1. Define a pure culture, a mixed culture. 2. Define a bacterial colony. List four characteristics by which bacterial colonies may be distinguished. 3. Why should a Petri dish not be left open for any extended period? 4. Why does the streaking method of plates inoculation result in isolated colonies? 5. Why are culture media sterilized before use? 6. Discuss the relative value of broth and agar media in isolating bacteria from mixed cultures. 7. At what temperature does agar solidify? At what temperature does agar melt? 8. Define a culture medium. 9. Discuss some of the physical and chemical factors involved in the composition, and in the preparation, of a culture medium. 10. Why is it necessary to isolate individual colonies from a mixed growth? 11. Are the large numbers of microorganisms found in the mouth cause for concern? Explain. 12. Why are plate cultures incubated in the inverted position? 13. How do you decide which colonies should be picked from a plate culture of a mixed flora? 14. Why is it necessary to make pure subcultures of organisms grown from clinical specimens? 15. How can you determine whether a culture or subculture is pure? 16. What kinds of clinical specimens may yield a mixed flora in bacterial cultures? 17. When more than one colony type appears in a pure culture, what are the most likely sources of the extraneous organisms? | Section | Experiment description | Quantity of CFU | 1 | Control | | 2 | Hygienic hand antisepsis (washing with soap) | | 3 | Surgical hand antisepsis | | 4 | Antisepsis with antiseptic iodopyron | |
| Section | Experiment description | Quantity of CFU | | | | | | | | | | | | | | |
| 1 | Control | | | | | | | | | | | | | | | |
| 2 | Hygienic hand antisepsis (washing with soap) | | | | | | | | | | | | | | | |
| 3 | Surgical hand antisepsis | | | | | | | | | | | | | | | |
| 4 | Antisepsis with antiseptic iodopyron | | | | | | | | | | | | | | | |

Laboratory exercises

1. Experiment 3.
 Perform 2-nd period of bacteriological diagnosis (inspection and accumulation of pure cultures isolation of aerobic microorganisms): characterize morphology of two different types of colonies present on agar medium; determine morphology and purity of two different types of colonies using Gram stain; use aseptic technique and transfer the colony of Gram-negative microorganisms for subculturing on a surface of agar slant for microbial biomass accumulation

Laboratory report

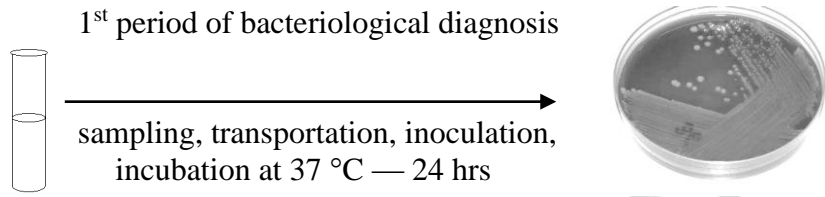

2nd period of bacteriological diagnosis (inspection and accumulation of pure culture)

| Description of colonies | | |
|-------------------------|------------|------------|
| Colony morphology | Colony № 1 | Colony № 2 |
| Shape | | |
| Size | | |
| Surface texture | | |
| Margin | | |
| Color | | |
| Density | | |
| Gram stain | | |

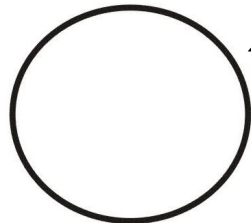
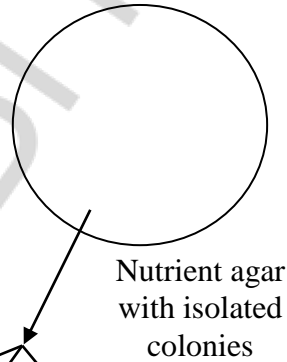

Smear _____
 Stain _____

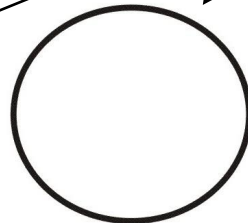

Smear _____
 Stain _____



Inoculation of slant media with isolated colony of gram-negative bacteria

Gram stain of two different types of colonies and selection gram-negative colonies

Signature of the tutor _____

Practical class № 6

BACTERIOLOGICAL METHOD OF LABORATORY DIAGNOSIS OF INFECTION DISEASES. TECHNIQUES FOR PURE CULTURE IDENTIFICATION

Suggested reading for self-study. Identification of microorganisms: approaches and methods. Bacterial species: definition of the term, species criteria and methods for discovering bacterial species. Using Bergey's manual of systematic bacteriology to identify bacteria.

Biochemical activities of bacteria and methods for the biochemical properties detection of microorganisms. Enzymes of microorganisms: classification, importance for identification: a) proteolytic (proteases, peptidases, decarboxylases, deaminases, cysteine desulfurase, urease, tryptophanase); b) carbohydrate hydrolyses (carbohydrase, amylase); c) lipolytic (lipases, lecithinase); d) oxidative-reductive (dehydrogenase, oxidase, catalase); e) hemolysins; α -, β -, γ -hemolysis.

Rapid multitest systems for identification of microorganisms. Automatic bacteriological analyses: structure and principle of bacterial identification.

Identification of microorganisms: approaches and methods.

Bacterial identification. The essential principle of bacterial identification is to assign an unknown culture to its place within the taxonomic classification system based on **as few characteristics as possible and as many as necessary**. The aim of identification is to detect what species the isolated pure culture belongs by studying different characteristics: morphological, cultural, biochemical, genetic, biological, antigenic, and ecological.

Species is a natural taxonomic category including a collection of bacterial cells, all of which share an overall similar pattern of traits, in contrast to other groups whose pattern differs significantly. Species criteria are those traits that allow identifying microorganisms to species level: morphological, cultural, biochemical, genetic, biological, antigenic, and ecological.

Strain — cultures of the same species derived from different ecological niches/at different time. They potentially can display variations in pattern of traits.

Vars (types) — cultures that differ in structure or metabolism from other cultures of that species (an example: biovars, morphovars).

Morphological characteristic. Light and electron microscopy are used to determine morphology. Traits that can be valuable aids to identification are combinations of cell shape (sphere, rod, spiral) and size, pseudogroupings (clusters, chains, diplococci), Gram stain reaction (Gram-positive, Gram-negative), acid-fast reaction, and special structures, including endospores, granules, and capsules (yes, no), flagella (presence, arrangement). Electron microscope studies can pinpoint additional structural features (such as the cell wall, pili, and fimbriae).

Cultural characteristics. Cultural characteristics include appearance of colonies on solid media: texture, size, shape, pigment, speed of growth; patterns of growth in broth and gelatin media, in different ranges of pH (alkaliphiles, acidophiles), temperature (psychro-, meso-, thermophiles), atmosphere conditions (aerobic, anaerobic etc.), unique nutritional requirements, the ability to grow in the presence of certain substances (sodium chloride, bile).

Biochemical characteristics. The ability to attack various substrates or to produce particular metabolic products have been the traditional mainstay of bacterial identification. Dozens of diagnostic tests exist for determining the presence of specific enzymes and to assess nutritional and metabolic activities. Biochemical and cultural tests for bacterial identification are analyzed by comparing with tables that show the reaction patterns of different individual species. In fact, advances in computer analysis have now been applied to identification of many bacterial and fungal groups. Biochemical properties include tests for the detection of:

- 1) respiratory chain enzymes (oxidases, catalases);
- 2) enzymes that break down carbohydrates, alcohols, glycosides;
- 3) protein metabolism enzymes (e.g., gelatinase, collagenase);

4) amino acid metabolism enzymes (e.g., decarboxylases, deaminases, urease);

5) other enzymes: hemolysins, lipases, lecithinases, DNases, etc.

Chemical composition of main bacterial structure. Analyzing the types of specific structural substances that the bacterium contains, such as the chemical composition of peptides, murein in the cell wall, fatty acids in membranes, end products of metabolism (e.g., organic acids detected by different chromatographic methods)

Biological characteristics. Susceptibility to antimicrobials (antibiotics, antiseptics, disinfectants) and phages, toxin production and other virulence factors detection may help in identification of microorganisms. In some diseases caused by production of a specific toxin, the toxin may be detected in vitro through cell cultures or immunologic methods. Neutralization of the toxic effect with specific antitoxin is the usual approach to identify the toxin.

Serological characteristics. Bacteria have surface and other molecules called antigens that are recognized by the immune system. One immune response to antigens is the production of molecules called antibodies that are designed to bind tightly to the antigens. Bacteria possess many antigens, such as capsular polysaccharides, flagellar proteins, and several cell wall components. Antigen structure is detectable with antibodies of known specificity. Laboratory kits based on this technique are available for immediate identification of a number of pathogens.

Genomic structure. Examining the genetic material itself has revolutionized the identification and classification of bacteria.

G + C base composition. The overall percentage of guanine and cytosine (the G + C content as compared with A + T content) in DNA is a general indicator of relatedness because it is a trait that does not change rapidly. Bacteria with a significant difference in G + C percentage are likely to be genetically distinct species or genera. For example, although superficially similar in Gram reaction, shape, and other morphological characteristics, *Escherichia* has a G + C base composition of 48–52 % and *Pseudomonas* has a composition of 58–70 %, indicating that they probably are not closely related. This technique is most applicable for clarifying the taxonomic position of a bacterium, but it is too nonspecific to be applicable as a precise identification tool.

DNA analysis using genetic probes and sequencing. The exact primary structure of the DNA is unique to each organism. With a technique called *hybridization*, or *PCR*, or *sequencing* it is possible to identify a bacterial species by analyzing segments of its DNA.

Biochemical activities of bacteria and methods for the biochemical properties detection of microorganisms. Enzymes of microorganisms: classification, importance for identification.

The ability to attack various substrates or to produce particular metabolic products have been the traditional mainstay of bacterial identification. It usually takes 18–24 hours to detect substrate utilization and determine if a microorganism has an enzyme. Biochemical properties and methods of their detection are listed in Table 6.1.

Table 6.1

Detection of biochemical properties of microorganisms

| Enzymes | Media | Positive reactions |
|---------------------------------------|---|---|
| Carbohydrate breakdown enzymes | | |
| Amylase | Starch media (nutrient agar with 0.2 % starch). Starch media contains the polysaccharide starch as a substrate (Fig. 6.2) | Organisms which produce amylase are able to hydrolyze starch will show a zone of clearing around the growth of the microorganism after treatment with iodine solution meanwhile the rest of medium will become violet |
| Carbohydrases | Differential media with lactose (Endo, Levin, McConkey agar) and dyes | <i>Escherichia coli</i> , <i>Klebsiella oxytoca</i> , <i>K. pneumonia</i> which ferment lactose will grow with colored colonies (purple or violet), <i>Salmonella</i> , <i>Shigella</i> which do not ferment lactose will grow with pale colonies |
| | Triple sure iron agar contain three carbohydrates: glucose (0.1 %), sucrose (1 %), and lactose (1.0 %), | Triple sure iron agar is used for the detection of 3 things: 1) carbohydrate fermentation; 2) gas production; 3) hydrogen sulfide production. |

| Enzymes | Media | Positive reactions |
|--------------------------------------|---|---|
| | as well as phenol red (pH indicator) and peptones. TSI slants also contain sodium thiosulfate and ferrous sulfate (Fig. 6.3) | <p>Carbohydrate fermentation: Fermentation of the carbohydrates into acid end-products will result in a yellow color. If glucose alone is fermented the slant becomes yellow, the butt stays red. If lactose is fermented the butt becomes yellow.</p> <p>Gas production. Production of gas (primarily CO₂) during fermentation can be determined by observing the tube for bubbles or cracks.</p> <p>Hydrogen sulfide production. If the microorganism produces hydrogen sulfide, it will utilize the sodium thiosulfate as a substrate, producing H₂S which reacts with the ferrous sulfate to cause a black precipitate</p> |
| | Liquid or semisolid media with one type of sugar and indicator of pH; pH of media are adjusted to 7.2±0.2. For detection of gas production a vacuole is added to liquid media | Utilization of sugars results in acid or acid plus gas production. Acidification of media is detected by pH indicator which changes its color. In case of gas production it is accumulated in vacuole and seen as bubbles, in semisolid media gas leads to holes in media or bubbles |
| Protein metabolism enzymes | | |
| Proteases | Casein media contains the substrate casein, which is a major milk protein | Organisms which produce protease and are able to hydrolyze casein will show zone of clearing around the growth of the microorganism (Fig. 6.2) |
| | Coagulated serum (like gel) | Organisms which produce protease will cause the coagulated serum to liquefy |
| | Tubes with gelatin gel, which is a protein produced by the hydrolysis of collagen | Some microorganisms possess an enzyme called <i>gelatinase</i> , which breaks down gelatin into amino acids. Organisms which hydrolyze gelatin (<i>Proteus vulgaris</i> , <i>Bacillus anthracis</i>) will cause the gelatin to liquefy |
| Amino acid metabolism enzymes | | |
| Deaminases | Media with amino acids and indicator of pH; pH of media are adjusted to 7.2±0.2. These tests are used primarily with Gram-negative rods | The deamination of the amino acids will cause the NH ₂ production alkalifying media and resulting in color shift of pH indicator |
| Decarboxylases | Media with one of the amino acids (lysine, ornithine and arginine) and indicator of pH; pH of media are adjusted to 7.2±0.2. These tests are used primarily with Gram-negative rods | The decarboxylation of the amino acids lysine, ornithine, and arginine is detected by the effect of the amino products on the pH of the reaction mixture |
| Indol production | Indole is a by-product of the metabolic breakdown of the amino acid tryptophan used by some microorganisms. Nutrient bullion or medium with tryptophan and indicator paper with oxalic acid fixed under the cap of the tube | The presence of indole in a culture grown in a medium containing tryptophan can be readily demonstrated by the formation of a red colored indicator paper. If indole is present, it combines with the oxalic acid on the surface of indicator paper to produce a pink-red color |
| Cysteine desulfurase | Hydrogen sulfide is produced when amino acids containing sulfur are metabolized by microorganisms. If the medium contains metallic ions, such as lead, bismuth, or iron, the hydrogen sulfide formed during growth combines | Once H ₂ S is produced, it combines with the ferrous ammonium sulfate, forming an insoluble, black ferrous sulfide precipitate that can be seen along the line of the stab inoculation |

| Enzymes | Media | Positive reactions |
|----------------------------------|--|---|
| | with the metallic ions to form a metal sulfide that blackens the medium. Usually medium with amino acids (cysteine) and $\text{Fe}(\text{NH}_4)\text{SO}_4$, as the H_2S indicator is used | |
| Urease | Urease broth with indicator of pH (phenol red); pH of medium is adjusted to 6.8 ± 0.2 | Urease hydrolyzes urea to yield two molecules of ammonia and one of CO_2 . This reaction can be detected by the increase in medium pH caused by ammonia production. Urease-positive species vary in the amount of enzyme produced; bacteria can thus be designated as positive, weakly positive, or negative |
| Lipid metabolism enzymes | | |
| Lipases | Triglycerides are hydrolyzed by the enzymes called lipases into glycerol and free fatty acid molecules. Lipid media with Tween-80 or egg yolk agar are used | Organisms which produce lipase and are able to hydrolyze lipids will show a rainbow thin film on the surface of medium around the growth of the microorganism seen in the reflected light |
| Lecithinase | Egg yolk agar (one chicken egg yolk is added to 300 ml of sterile and melted nutrient agar cooled to $45\text{--}50^\circ\text{C}$) | Organisms (<i>Staphylococcus aureus</i> , <i>Clostridium spp.</i> , <i>Fusobacterium spp.</i>) which produce lecithinase and are able to hydrolyze lecithin will show a zone of cloudiness (opacity) around the growth of the microorganism |
| Respiratory chain enzymes | | |
| Oxidase | Filter paper, 1 % solution of (tetramethyl-p-phenylenediamine dihydrochloride) — oxidase test reagent are used. Oxidase (cytochrome oxidase (aa3 type)) enzymes play an important role in the operation of the electron transport system during aerobic respiration | The ability of bacteria to produce cytochrome oxidase can be determined by the addition of 2 to 3 drops of the oxidase test to the surface of filter paper strip which is subsequently inoculated with bacteria culture. The presence of this dark purple coloration represents a positive test. No color change or a light pink coloration of the strip indicates the absence of oxidase. Test is widely used to differentiate <i>Escherichia coli</i> which are oxidase negative and <i>Pseudomonas aeruginosa</i> which are oxidase positive. <i>Escherichia coli</i> — facultatively anaerobic gram-negative rod that has both respiratory and fermentative types of metabolism. <i>Pseudomonas aeruginosa</i> — a gram-negative, aerobic rod having a strictly respiratory type of metabolism |
| Catalase | A drop of 3 % hydrogen peroxide on a glass slide | The enzyme catalase catalyzes the conversion of hydrogen peroxide to water and oxygen. When a colony is placed in hydrogen peroxide, liberation of oxygen as gas bubbles can be seen. The test is particularly useful in differentiation of staphylococci (positive) from streptococci (negative) (Fig. 6.4). |
| Toxins | | |
| Hemolysins | 5 10 % blood agar | -hemolysis — partial hemolysis — alpha-hemolytic microorganisms will show a greenish zone around the growth of the microorganism meanwhile the rest of medium will stay red; -hemolysis — full hemolysis — beta-hemolytic microorganisms will show a zone of clearing around the growth of the microorganism meanwhile the rest of medium will stay red; -hemolysis — absence of visible hemolysis |

| Enzymes | Media | Positive reactions |
|---------------------------|---|---|
| Coagulase | 0.4 ml sterile plasma of rabbits in tube is inoculated with loop full of bacteria | The enzyme coagulase acts (30 min, 37 °C) with a plasma factor to convert fibrinogen to a fibrin clot. It is used to differentiate <i>Staphylococcus aureus</i> from other, less pathogenic staphylococci |
| Deoxyribonuclease (DNase) | Some microorganisms secrete an enzyme that attacks the deoxyribonucleic acid (DNA) molecule. Nutrient agar with DNA is used. has opaque. The uninoculated medium is opaque and remains so after the culture has grown | After 24 hours of incubation inoculated media the plate is flooded with weak hydrochloric acid (1 N), a zone of clearing appears around colonies that have produced DNase. This clearing occurs because the large DNA molecule has been degraded by the enzyme, and the end products dissolve in the added acid. Intact DNA does not dissolve in weak acid but rather is precipitated by it; therefore, the medium in the rest of the plate, or around colonies that do not produce DNase |
| Cytotoxines | Epithelial cell lines and ultra filtrate of broth culture of microorganisms. Ultrafiltration is a necessary step to delete microorganisms and purify toxin | Each cell line has it's typical easily detected morphological properties which disappear under the toxin |
| Volatile fatty acids | Gas-liquid chromatography of specimens or culture media is performed. Used for preliminary diagnosis of anaerobic infections | Volatile fatty acids (propionic, butyric, valerianic, caproic) are separated in chromatographic column according their molecular weight. Presence in the specimen one of the VFAs confirms anaerobic infection |



Figure 6.1. Organisms which hydrolyze will cause the gelatin to liquefy

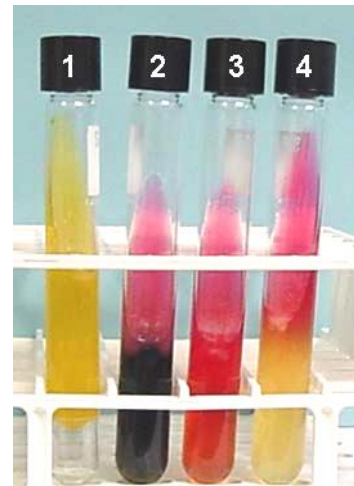

Figure 6.3. Triple Sugar Iron (TSI) Agar:
 1 — *E. coli*: glucose +, lactose+, H₂S –
 2 — *Salmonella*: glucose +, lactose –, H₂S +
 3 — Control: glucose –, lactose –, H₂S –
 4 — *Shigella*: glucose +, lactose –, H₂S –



Figure 6.2. Amylase and proteases detection

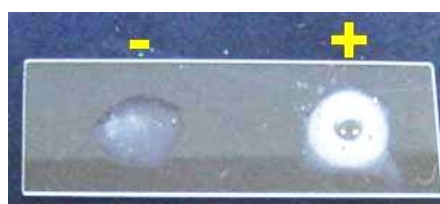
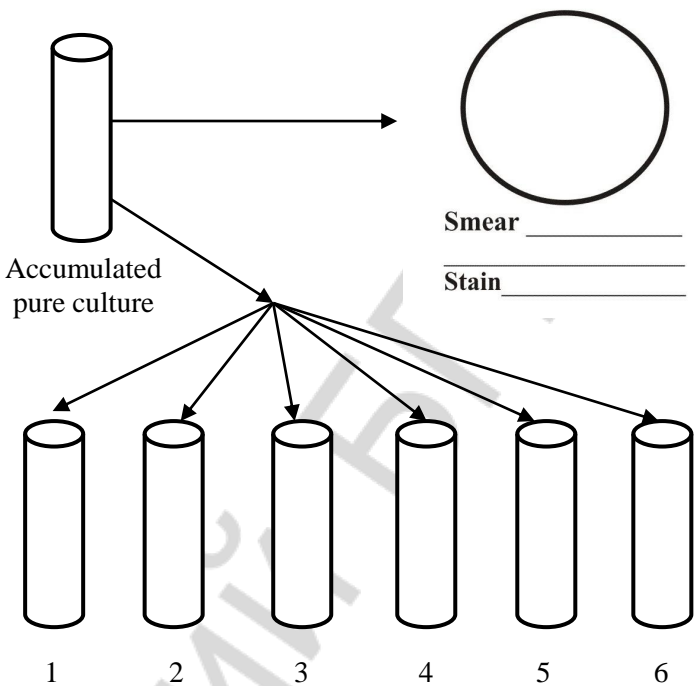

Figure 6.4. Catalase detection

| Laboratory exercises | Laboratory report |
|---|---|
| <p>1. Register the results of experiment on antiseptics (see classes № 5).</p> <p>2. Perform 3-nd period of bacteriological diagnosis (identification of pure cultures of aerobic microorganisms):</p> <ul style="list-style-type: none"> determine morphology and confirm purity of agar slant culture; using stab technique inoculate Hiss media with sucrose, maltose, mannitol for the determination of bacterial carbohydrate hydrolyses; using stab and streaking technique inoculate Kligler Iron agar for the determination of bacterial carbohydrate hydrolyses and H₂S production; using stab technique inoculate semisolid tube medium to detect motility; inoculate nutrient broth and test the culture for the indole production. <p>Demonstration:</p> <ul style="list-style-type: none"> Semisolid and liquid Hiss media with different pH indicators; Hemolysis on blood agar medium, lecithinase activity, indol detection; Differentiate among members of the family <i>Enterobacteriaceae</i> using Kligler Iron agar; Rapid multitest systems for identification of microorganisms | <div style="text-align: center;">  <p>Accumulated pure culture</p> <p>Smear _____</p> <p>Stain _____</p> <p>1 2 3 4 5 6</p> </div> <ol style="list-style-type: none"> 1. Semiliquid nutrient medium for motility detection. 2. Triple sugar iron agar for the detection of glucose, lactose fermentation and H₂S production. 3. Hiss medium with sucrose. 4. Hiss medium with maltose. 5. Hiss medium with mannitol. 6. Nutrient bullion with indicator paper for indole detection. |
| <p>Signature of the tutor _____</p> | |

Practical class № 7

MOLECULAR BASIS OF BACTERIAL GENETICS. MOLECULAR METHODS OF INFECTION DISEASES DIAGNOSIS AND BACTERIAL GENETIC INVESTIGATIONS

Suggested reading for self-study. The structure of bacterial genetic apparatus. Phenotype, genotype, genome, genes. Regulation of gene expression. General properties and varieties of plasmids. Detection of plasmids. Mobile genetic elements: transposons and IS elements.

Bacterial variability: phenotypic and genetic. Practical significance of bacterial variability. Mechanisms of genetic variability: Mutation and recombination. Classification of mutations. Methods of mutant bacteria selection.

Horizontal gene transfer: transformation, transduction, conjugation.

Molecular methods: tasks, specimens for investigation, advantages of the methods. Classification of molecular methods.

Molecular hybridization: test materials, DNA extraction, components of DNA hybridization reaction, molecular probes, detection of DNA hybrid duplexes, interpretation of results. Equipment. Practical application of molecular hybridization method.

Polymerase chain reaction (PCR): test materials, principle, DNA extraction, components of PCR reaction mixture, primers, PCR thermal cycle, detection of amplicons, interpretation of results. Equipment for PCR. Practical application of PCR.

Genomics. Bioinformatics. Genetic engineering. Gene Cloning.

Class 7. Practical part

Date _____

| Laboratory exercises | Laboratory report | | | | | | | | | | |
|---|--------------------------|------------|--------------------------|-----------------------------|---------|----------|---------|------------------|--------|----------|---|
| | Species | Morphology | Cultural characteristics | Biochemical characteristics | | | | | | | |
| Glucose | | | | Lactose | Maltose | Mannitol | Sucrose | H ₂ S | Indole | Motility | |
| 1. Identify isolated pure culture and complete the final report: Register the biochemical properties of tested pure culture in table; Analyze the results and determine the specie of tested pure culture | <i>E. coli</i> | Rods, Gr- | S-colonies | AG | AG | AG | AG | - | - | + | + |
| | <i>S. typhi</i> | Rods, Gr- | S-colonies | A | - | A | A | - | + | - | + |
| | <i>S. paratyphi A</i> | Rods, Gr- | S-colonies | AG | - | AG | AG | - | - | - | + |
| | <i>S. schottmuelleri</i> | Rods, Gr- | S-colonies | AG | - | AG | AG | - | + | - | + |
| | <i>X-microbe</i> | | | | | | | | | | |
| Report: According to morphological, cultural, biochemical properties X-microbe is attributed to _____ | | | | | | | | | | | |

| Laboratory exercises | Laboratory report |
|--|--|
| <p>2. Perform a bacterial conjugation experiment:</p> <p>Prepare the mating mixture by aseptically transferring 0.5 ml of an overnight meat-pepton brothculture of donor and recipient <i>E. coli</i> into separate tube;</p> <p>Mix and incubate at 37 °C for 1 hours;</p> <p>Confirm the resistance status and leucine and treonine production by culturing donor, recipient and recombinant <i>E. coli</i> on minimal medium supplemented with streptomycin</p> | <p>In bacterial conjugation experiment donor <i>E. coli</i> is susceptible to streptomycine and synthesizes treonine and leucine. Recipient <i>E. coli</i> displays complementary properties: resistant to streptomycine and unable to synthesize treonine and leucine. Recombinants of these two strains will have combination of either the donor or recipient strains' characteristics and can be readily detected by using selective minimal media.</p> <div data-bbox="491 450 1353 1055" style="text-align: center;"> </div> <p>Registration of results after 24 hours incubation at 37 °C</p> <p>Conclusion _____</p> |
| <p>3. Perform PCR for the detection of <i>M. tuberculosis</i> in the sputum of patient with tuberculosis suspected.</p> <p>4. Demonstration:</p> <p><u>Replica</u> method for bacterial mutant forms selection</p> | <p><i>Identification of M. tuberculosis</i> in sputum is based on the detection of gen MPB64 unique for <i>M. tuberculosis</i> and <i>M. bovis</i>. PCR amplifies the fragment with the size 357 bp. of this gen.</p> <p style="text-align: center;">Procedure of PCR</p> <p>DNA extraction: Mark the tubes with the volume 1.5 ml with letters S (sputum) and NC (control). Add 100 µl of sputum to tube with letter S and 100 µl of negative control to tube marked with letter NC. Shake the tubes thoroughly and boil in water bath for 10 minutes (in room 507).</p> <p>PCR cocktail preparation: Mark the tubes with the volume 0.5 ml with letters S (sputum) and NC (control). This tubes contain primers, dNTPs, MgCl₂. Add 10 µl of prepared DNA and 10 µl of extracted DNA. Amplification in special equipment — thermocycler — for approximately 1 hour.</p> <p>Detection of PCR products: Electrophoresis of PCR products in agarose gel. UV detection of specific PCR-products in gel with ethidium bromide.</p> <p>Report: <u>Specific products sized 357 bp</u> detected _____. <u>Sputum is positive or negative for Mycobacterium tuberculosis</u> _____</p> |
| <p>Signature of the tutor _____</p> | |

Practical class № 8

ECOLOGY OF MICROORGANISMS. METHODS OF HUMAN NORMAL FLORA INVESTIGATION. INFECTIONS

Suggested reading for self-study. Ecology of microorganisms. Basic terminology of ecology. Interspecific and intraspecific relations. Symbiosis, its variants. Antagonistic microbial relationships, its background and medical importance. Bacteriocins.

Diversity of microorganisms, inhabiting soil, water and air. Diversity of normal flora at different sites of human body. Origin of the normal flora. Beneficial effects of the normal flora. Methods of normal flora investigation. Gnotobiology. Dysbacteriosis: aetiology, pathogenesis, symptoms, approaches to treatment, prophylaxis.

Basic terminology of infectiology. Definition of infection. Classification of infections. Bacterial pathogenicity and virulence. Measurements of virulence: ID₅₀, LD₅₀, DLM. The Henle–Koch Postulates. The genetics of bacterial pathogenicity. Pathogenicity islands. Pathogenicity factors: adhesins, invasins, impedins, aggressins, modulins. The role of bacterial biofilms. Methods of detection of adhesins, capsule, invasins, toxigenicity.

Ecology of microorganisms. Basic terminology of ecology. Interspecific and intraspecific relations. Symbiosis, its variants. Antagonistic microbial relationships, its background and medical importance. Bacteriocins.

Microbes live in shared habitats, which give rise to complex associations. Interactions in these associations can have beneficial, harmful, or no particular effects on the organisms involved; they can be obligatory or nonobligatory to the members (Table 9.1).

Table 9.1

Microbial associations

| Symbiotic | | | Non-symbiotic | |
|--|--|---|--|---|
| Organisms live in close nutritional relationships; required by one or both members | | | Organisms are free-living; relationships not required for survival | |
| Mutualism | Commensalism | Parasitism | Synergism | Antagonism |
| obligatory; dependant; both member benefit | The commensal benefits; other members not harmed | Parasite is dependant and benefits; host harmed | Members cooperate and share nutrients | Some members are inhibited or destroyed by others |

Symbiosis — interactions in which two organisms live together in a close partnership.

Mutualism — a form of symbiosis in which organisms live in an obligatory but mutually beneficial relationship. This association is rather common in nature because of the survival value it has for the members involved.

Commensalism — interactions when the commensal receives benefits, while its coinhabitant is neither harmed nor benefited.

Satellitism — it is a form of commensalism when one member provides nutritional or protective factors to the other. On agar media *Haemophilus influenzae* grows faster and more intensively in the presence of *S. aureus* which produces growth factors necessary for *H. influenzae*.

Parasitism — a relationship in which the host organism provides the parasitic microbe with nutrients and a habitat. Multiplication of the parasite usually harms the host to some extent.

Synergism is an interrelationship between two or more free-living organisms that benefits them but is not necessary for their survival. Together, the participants cooperate to produce a result that none of them could do alone.

Antagonism is an association between free-living species that arises when members of a community compete. In this interaction, one microbe secretes chemical substances into the surrounding environment that inhibit or destroy another microbe in the same habitat. The first microbe may gain a competitive advantage by increasing the space and nutrients available to it. The production of inhibitory compounds called antibiotics or bacteriocins — is actually a form of antagonism.

Normal flora of human body.

Microbes that normally live on the skin, in the alimentary tract, and in other sites are called the normal microbial flora **or indigenous microbiota**. It has been calculated that a human adult houses about 10^{12} bacteria on the skin, 10^{10} in the mouth, and 10^{14} in the gastrointestinal tract. The latter number is far in excess of the number of eucaryotic cells in all the tissues and organs which comprise a human. The normal flora of humans consists of a few eucaryotic fungi and protists, but bacteria are the most numerous and obvious microbial components of the normal flora. A recent experiment that used 16S RNA probes to survey the diversity of bacteria revealed about 400–500 species colonizing different sites of human body. The bacterial flora of humans is sufficiently constant but may be influenced by various factors, including genetics, age, sex, stress, nutrition and diet of the individual. Three developmental changes in humans, weaning, the eruption of the teeth, and the onset and cessation of ovarian functions, invariably affect the composition of the normal flora in the intestinal tract, the oral cavity, and the vagina, respectively. A human first becomes colonized by a normal flora at the moment of birth and passage through the birth canal, as in utero, the fetus is sterile. Handling and feeding of the infant after birth leads to establishment of a stable normal flora on the skin, oral cavity and intestinal tract in about 48 hours.

The effects of the normal flora are studied by microbiologists from experimental comparisons between “**germ-free**” animals (which are not colonized by any microorganisms) and conventional animals (which are colonized with a typical normal flora). Due to lack of exposure to a normal flora germ-free animals displays the following:

- 1) vitamin deficiencies, especially vitamin K and vitamin B12;
- 2) increased susceptibility to infectious disease;
- 3) poorly developed immune system, especially in the gastrointestinal tract;
- 4) lack of “natural antibody” or natural immunity to bacterial infection.

Because these conditions in germ-free mice and hamsters do not occur in conventional animals, or are eliminated by introduction of a bacterial flora (at the appropriate time of development), the human normal flora make similar contributions to human nutrition, health and development.

The overall beneficial effects of microbes are summarized below:

1. **The normal flora acts as nutrients and active metabolites source.** Normal flora synthesize vitamins (B, K). Vitamin K is essential for the synthesis of clotting factors II, VII, XI.

2. **The normal flora** confer the infection resistance via passive and active antagonism with pathogens:

a) the normal flora prevent colonization by pathogens **by competing for attachment sites or for essential nutrients** (passive antagonism). In some experiments, germ-free animals can be infected by 10 *Salmonella* bacteria, while the infectious dose for conventional animals is near 10^6 cells. Some gut bacteria produce mucins preventing the attachment of pathogens;

b) the normal flora may antagonize other bacteria **through the production of substances which inhibit or kill nonindigenous species** (active antagonism). The intestinal bacteria produce bacteriocins, antibiotics, metabolites (fatty acids, lactic acid), which inhibit or kill other bacteria. Lactobacilli residing in the vagina help maintain an environment that protects against infection by other microorganisms.

3. **The normal flora stimulate the immune system:**

a) normal flora stimulate the production of natural antibodies. Since the normal flora behave as antigens in an animal, they induce an immunological response, in particular, an antibody-mediated immune (AMI) response. Because cross-reactivity between related bacteria, the antibodies produced in response to normal flora confer protection to the host from many pathogenic bacteria. Antibodies produced against antigenic components of the normal flora are sometimes referred to as “natural” antibodies, and such antibodies are lacking in germ-free animals;

b) stimulates development of the intestinal lymphatic tissues. Lymphatic tissues of germ-free animals are poorly-developed compared to conventional animals.

4. **Detoxification some metabolites — hormones, bile salts etc.**

5. **The normal flora stimulate the development of certain tissues and** metabolism of epithelial cell. The caecum of germ-free animals is enlarged, thin-walled, and fluid-filled, compared to that organ in conventional animals. Anaerobic microflora produce volatile fatty acids: butyric, valeric, caproic. Produced by them butyric acid is used in energy metabolism of colon epithelial cells enabling their growth and differentiation and preventing carcinogenesis.

To restore balance of normal flora prebiotics and probiotics are used in medical practice.

Prebiotics — non-digestible food ingredients that stimulate the growth and/or activity of bacteria in the digestive system which are beneficial to the health of the body. They were first identified and named by Marcel Roberfroid in 1995. They are considered a functional food.

Typically, prebiotics are oligosaccharides, for example oligofructose, or inulin. Prebiotic increases the number and/or activity of *Bifidobacterium spp.* and *Lactobacterium spp.* The importance of these microorganisms is that they improve digestion and the effectiveness of the immune system.

Probiotics are live microorganisms representing human normal flora, which when administered in adequate amounts confer a health benefit on the host (improve intestinal microbial balance, inhibit pathogens and toxin producing bacteria). Etymologically, the term originated from Latin preposition *pro* (“for”) and the Greek adjective *βιωτικός* (biotic, bios, “life”). The probiotics are non pathogenic, non toxic microorganisms that produce useful enzymes or physiological end-products, remain viable for a long period and withstand stomach acid and bile salts. Probiotics are commonly consumed as part of fermented foods with specially added active live cultures; such as yogurt, sour milk. Pharmacological preparations of probiotics consist of separate lactobacteria, bifidobacteria, streptococci or their combination as in Linex (contain combination of *Lactobacillus acidophilus*, *Bifidobacterium infantis v. liberorum*, *Streptococcus faecium*).

The original observation of the positive role played by certain bacteria was first introduced by Russian scientist and Nobel laureate Eli Metchnikoff, who in the beginning of the 20th century suggested that it would be possible and to replace harmful microbes in gut by useful microbes. Metchnikoff, at that time a professor at the Pasteur Institute in Paris, produced the notion that the aging process results from the activity of putrefactive (proteolytic) microbes producing toxic substances in the large bowel responsible for “auto-intoxication”. Metchnikoff proposed that consumption of fermented milk would “seed” the intestine with harmless lactic-acid bacteria and decrease the intestinal pH and that this would suppress the growth of proteolytic bacteria. Metchnikoff himself introduced in his diet sour milk fermented with the bacteria “Bulgarian Bacillus” (now *Lactobacillus delbrueckii subsp. bulgaricus*), and found his health benefited.

Bacteriocins are proteinaceous toxins produced by bacteria to inhibit the growth of similar or closely related bacterial strain. They are considered to be narrow spectrum antibiotic-like substances. Bacteriocins were first discovered by A. Gratia in 1925. The bacteriocins from *E. coli* are called *colicins*, produced by *Staphylococcus warneri* — warnericins, by *Yersinia pestis* — pesticins, by *Corynebacterium spp.* — corycins, *Pseudomonas aeruginosa* — aeruginocins. Bacteriocins are classified in several ways, including producing strain, mechanism of killing, molecular weight and chemical structure, genetic origin.

Classification by method of killing: pore forming, displaying activity of DNAase, nuclease, inhibition of murein production.

Classification by genetic determinants: large plasmids, small plasmids, chromosome coded bacteriocins.

Classification by molecular weight and chemistry: large protein, polypeptide, with/without sugar moiety, containing atypical amino acids like lanthionine.

Bacteriocins are divided into class I, class IIa/b/c, and class III.

Medical importance of bacteriocins. They work as factors of colonization and allow surviving of non pathogenic microorganisms in polymicrobial associations. In human intestine 1 out of 1000 *E. coli* is able to produce bacteriocin. Being produced by nonpathogenic colonizers of human body biotopes bacteriocins inhibit pathogenic microorganisms defending organism from infection initiation.

Bacterial pathogenicity and virulence. Measurements of virulens: ID₅₀, LD₅₀, DLM. The genetics of bacterial pathogenicity. Pathogenicity islands. Pathogenesis factors: adhesins, invasins, impedins, aggressins, modulins.

The likelihood that a disease results from an infection will increase with: 1) increasing numbers of microorganisms; 2) decreasing resistance of the host. Certain predisposing factors may make the body more susceptible to disease or may alter the course of a disease. These factors include:

Pathogenicity — the ability to cause disease in a host by overcoming the defenses of the host.

Virulence is the degree of pathogenicity. Pathogenicity and virulence are sometimes even used synonymously. Virulence can be expressed as the LD₅₀ and ID₅₀. The lower the LD₅₀ or ID₅₀ for an organism, the more virulent the organism.

The **LD₅₀** is the number of microorganisms (or amount of toxin) needed to kill 50 % of inoculated hosts (a test population) under standard conditions. (lethal dose for 50 % of the inoculated hosts) or ID₅₀ (infectious dose for 50 % of the inoculated hosts).

The **ID₅₀** (infectious dose) is the number of microorganisms needed to cause disease in 50 % of the test population under standard conditions.

Toxins — poisonous substances produced by microorganisms are called toxins; toxemia refers to the presence of toxins in the blood. The ability to produce toxins is called toxigenicity.

Antitoxins are antibodies produced against exotoxins. Antitoxines bind to exotoxins, thus inactivating the exotoxin. Injection of *antitoxin* provides passive immunity and is used for emergent prophylaxis and therapy of diseases.

Toxoid is a physically or chemically inactivated exotoxin with immunogenic but not toxic properties. *Toxoids* are employed as vaccines, since they induce a host immune response.

Phases in microbial pathogenesis:

1. Adhesion to host cells (adhesins).
2. Breaching of host anatomical barriers (invasins) and colonization of tissues (aggressins).
3. Strategies to overcome nonspecific defenses, especially antiphagocytic mechanisms (impedins).
4. Strategies to overcome specific immunity, the most important of which is production of IgA proteases (impedins), molecular mimicry, and immunogen variability.
5. Damage to host tissues due to direct bacterial cytotoxicity, exotoxins, and exoenzymes (aggressins).
6. Damage due to inflammatory reactions in the macroorganism: activation of complement and phagocytosis; induction of cytokine production (modulins).

There are five groups of pathogenicity factors:

1. **Adhesins.** They facilitate adhesion to specific target cells.
2. **Invasins.** They are responsible for active invasion of the cells of the macroorganism.
3. **Impedins.** These components disable host immune defenses in some cases.
4. **Aggressins.** These substances include toxins and tissue-damaging enzymes.
5. **Modulins.** Substances that induce excess cytokine production (i.e., lipopolysaccharides of Gram-negative bacteria, superantigens, murein fragments).

Exotoxins and endotoxins.

1. **Exotoxins** are produced by living bacteria (mostly gram-positive) and released into the surrounding medium. Exotoxins play a pivotal role in producing the specific disease symptoms. They may be classified according to what **type of cells they attack**: neurotoxins, cardiotoxins, hepatotoxins, leukotoxins, enterotoxins, cytotoxins (wide variety of cells).

There are three basic types of exotoxin based on structure and function: 1) A-B toxins; 2) membrane disrupting toxins; 3) superantigens.

A-B toxins. Most exotoxins are A-B or type III toxins. A-B toxins consist of two polypeptides. The A polypeptide is the enzyme and the B polypeptide is a binding component. B binds to the cell, the complete toxin is taken into the cell, the two subunits separate, and the A subunit enzymatically kills the cell.

Membrane disrupting toxins. Type II toxins, disrupt host cell plasma membranes. Leukocidins kill phagocytes. Hemolysins destroy erythrocytes. Streptolysins are hemolysins produced by *Streptococci*.

Superantigens. Type I toxins, provoke intense immune responses.

Representative of exotoxins:

Cytotoxins: a) Diphtheria toxin (A-B toxin which inhibits protein synthesis) — *Corynebacterium diphtheria*; b) Erythrogenic toxins (superantigens that damage capillaries) — *Streptococcus pyogenes*.

Neurotoxins: a) Botulinum toxin (A-B toxin which prevents nerve impulse transmission from motor neuron to muscle fiber at motor endplate, results in flaccid paralysis) — *Clostridium botulinum*; b) Tetanus toxin, or tetanospasmin (A-B toxin which prevents inhibitory nerve transmission, results in spasmodic muscle contractions) — *Clostridium tetani*.

Enterotoxins (induce fluid and electrolyte loss from host cell): 1) *Vibrio* enterotoxin — A-B toxin produced by *Vibrio cholerae*, stimulates secretion of fluid and electrolytes by mucosal epithelial cells, results in diarrhea; 2) *Staphylococcus aureus* enterotoxin — a superantigen that produces the same results as *Vibrio* enterotoxin.

2. Endotoxins are lipopolysaccharides (LPS), the lipid A component of the wall of gram-negative bacteria. *Endotoxins* exert their effect only upon release from the bacterial cell envelope. This typically occurs only upon bacterial cell lysis. Since LPS is found solely on gram-negative bacteria, *endotoxins* are also associated exclusively with gram-negative bacteria. Bacterial cell death, antibiotics, and antibodies may cause the release of endotoxins. All *endotoxins* produce the same symptoms. Host responses include: fever, chills, weakness, aches, shock, generalized inflammatory syndrome. Endotoxins cause fever by inducing the release of interleukin-1 and shock by inducing TNF release resulting in blood pressure decrease in). Besides, TNF causes edema by damaging capillaries. LPS stimulates release of NO from macrophages, which causes vasodilation. Endotoxins allow bacteria to cross the blood-brain barrier.

Pathogenicity islands (PAIs) are a distinct class of genomic islands which are acquired by horizontal transfer and encode genes which contribute to the virulence control. They are incorporated in the genome of pathogenic microorganisms but are usually absent from those non-pathogenic organisms of the same or closely related species. They usually occupy relatively large genomic regions ranging from 10–200 kb. Pathogenicity islands encode adherence factors, toxins, iron uptake systems, invasion factors and secretion systems. One species of bacteria may have more than one PAI. (i.e. *Salmonella* has at least 5). PAIs are located mostly in gram-negative cells, but have been shown to appear in some gram-positive cells. They are located in pathogens that undergo gene transfer by plasmid, phage, or a conjugative transposon. They are transferred through horizontal gene transfer.

Properties of PAIs:

1. PAIs carry genes encoding one or more virulence factors: adhesins, toxins, invasins, etc.
2. They are located on bacterial chromosome or may be a part of a plasmid.
3. The GC-content of pathogenicity islands often differs from that of the rest of the genome.
4. They are flanked by direct repeats: the sequence of bases at two ends are the same.
5. PAIs are associated with tRNA genes, which target sites for the integration of DNA.
6. PAIs carry functional genes, responsible for horizontal transfer — integrase, transposase, or part of insertion sequences.
7. Represent unstable DNA regions. May move from one tRNA locus to another or be deleted.

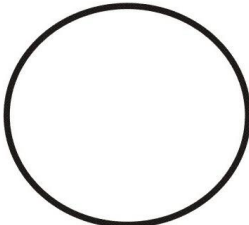
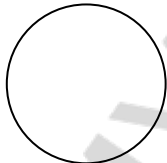
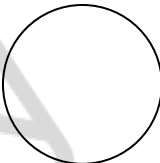
| Laboratory exercises | Laboratory report | | | | | | | | | | | | | | | |
|--|---|---|---------|------------|---|--|---|--|---|--|---|--|---|--|---|--|
| <p>1. Perform isolation of normal flora from skin and mucus membrane surfaces to gain an understanding of the diversity of microorganisms at these body locations and exclude/confirm disbiosis.</p> <p>2. Prepare heat-fixed smear from dental plaque, Gram stain, explore under microscope, complete the report.</p> <p>3. Register the results of bacterial conjugation experiment (see class № 7).</p> <p>Demonstration:</p> <p>1. Slide with dental plaque, Gram stain.</p> <p>2. Methods for detection of pathogenicity factors (capsule, hemolysins, lecithinase, coagulase)</p> | <p>Divide agar plates into four sections with a marking pen or pencil. Label each section with 1, 2, 3, 4. Label each plate with group number and your name.</p> <p>Add sterile isotonic solution to the Petri dish with sterile filter paper squares (1×1 cm). Use flamed forceps to cover with the squares of filter paper for 0.5 min the various body sites which normal flora is to be investigated (hands, lips, forehead, mucus membranes of tongue, cheeks). Put the squares of filter paper for 1 minute on the surface of blood and MacConkey agar.</p> <p>Fill in the table with the sites which microbial flora is under study.</p> <p>Incubate the plates at 37 °C for 24–48 hours.</p> <div style="text-align: center; margin-top: 20px;">  <p>Smear _____</p> <p>_____</p> <p>Stain _____</p> <p>_____</p> </div> | <div style="display: flex; justify-content: space-around; align-items: center;"> <div style="text-align: center;">  <p>Blood agar</p> </div> <div style="text-align: center;">  <p>MacConkey agar</p> </div> </div> <table border="1" style="margin-top: 20px; width: 100%; border-collapse: collapse;"> <thead> <tr> <th style="width: 15%;">Section</th> <th style="width: 85%;">Body sites</th> </tr> </thead> <tbody> <tr><td style="text-align: center;">1</td><td></td></tr> <tr><td style="text-align: center;">2</td><td></td></tr> <tr><td style="text-align: center;">3</td><td></td></tr> <tr><td style="text-align: center;">4</td><td></td></tr> <tr><td style="text-align: center;">5</td><td></td></tr> <tr><td style="text-align: center;">6</td><td></td></tr> </tbody> </table> | Section | Body sites | 1 | | 2 | | 3 | | 4 | | 5 | | 6 | |
| Section | Body sites | | | | | | | | | | | | | | | |
| 1 | | | | | | | | | | | | | | | | |
| 2 | | | | | | | | | | | | | | | | |
| 3 | | | | | | | | | | | | | | | | |
| 4 | | | | | | | | | | | | | | | | |
| 5 | | | | | | | | | | | | | | | | |
| 6 | | | | | | | | | | | | | | | | |
| <p>Signature of the tutor _____</p> | | | | | | | | | | | | | | | | |

Perform registration of results at class № 9

Register the results of experiment on normal flora isolation from skin and mucus membrane surfaces, Gram stain different types of colonies, explore under microscope, complete the report

Analysis of results of experiment on normal flora isolation from skin and mucus membrane surfaces

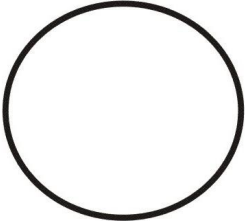
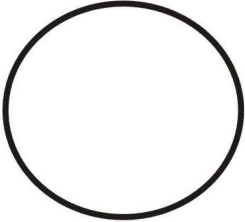
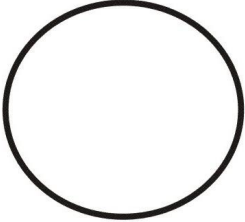
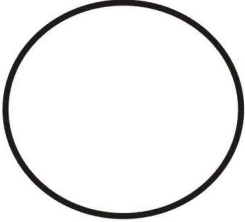
| Body site | Media | Amount of colonies | Description of colonies | Gram stain |
|-----------|------------|--------------------|-------------------------|---|
| | Blood agar | | |  Smear _____ Stain _____ |
| | Mac-Conkey | | | |
| | Blood agar | | |  Smear _____ Stain _____ |
| | Mac-Conkey | | | |
| | Blood agar | | |  Smear _____ Stain _____ |
| | Mac-Conkey | | | |
| | Blood agar | | |  Smear _____ Stain _____ |
| | Mac-Conkey | | | |

Practical class № 9

ANTIBIOTIC SUSCEPTIBILITY TESTING OF MICROORGANISMS. APPLICATION OF LABORATORY ANIMALS IN MICROBIOLOGY

Suggested reading for self-study. Definitions: chemoprophylaxis and chemotherapy; antimicrobial chemotherapeutic agents and antibiotics. Sources of antibiotics. Spectrum of action. Chemical classification of antibiotics. Mechanisms of action. Side effects. Principles for rational antimicrobial therapy.

The problem of resistance to antimicrobials: definitions (intrinsic, acquired resistance), incidence, significance. Resistance mechanisms: non-genetic and genetic origin of drug resistance. Biochemical resistance. Beta-lactamases. Evolution of resistance to anti-infective agents. Antibiotic susceptibility testing of microorganisms: methods and principles. Minimal inhibitory concentration. Procedures of agar and broth dilution tests and Kirby-Bauer agar disk diffusion test.

Biological method (application of laboratory animals in microbiology): tasks, phases, evaluation of the method. Animal models for infection diseases. Routs for animal infection. Ethical, humane and legal considerations involved in the use of laboratory animals.

Definitions: chemoprophylaxis and chemotherapy; antimicrobial chemotherapeutic agents and antibiotics.

Chemotherapy is the treatment of diseases by chemicals. Antimicrobial chemotherapy involves the use of drugs to control infection on or in the body. Antimicrobial therapy includes three interacting factors: the drug, the microbe, and the infected host.

Chemoprophylaxis is the administration of antimicrobial chemotherapeutic agents for the prevention of infections; chemoprophylaxis should be initiated only when the benefits of treatment outweigh the risks. Prophylaxis can reduce the risk of endogenous infection associated with certain surgical and dental procedures if given during the procedure (a few hours at most). The transmission of highly infectious bacteria to close contacts can also be reduced by prophylaxis. This has been effective for some pathogens spread by the respiratory route, such as the etiologic agents of meningitis, whooping cough, and plague. One of the outstanding successes of antimicrobial prophylaxis is the reduction of group B streptococcal sepsis and meningitis in neonates. In this instance, prophylactic penicillin is administered during labor to mothers with demonstrated vaginal group B streptococcal colonization.

Antimicrobial chemotherapeutic agent — a broad term that encompasses chemical substances, including antibiotics, used in the treatment of infectious diseases. This special class of compounds capable even in high dilutions of destroying or inhibiting microorganisms.

The term antibiotic strictly refers to substances that are of biological origin.

Antibiotic — antimicrobials of biological origin, most of which are produced by fungi or by bacteria of the genus *Streptomyces*, displaying “selective toxicity” and inhibiting or destroying bacteria at very low concentration without causing damage to the macroorganism.

Empiric antimicrobial therapy — therapy based on the physician’s assessment of the probable microbial etiology of the patient’s infection and knowledge about standard susceptibility pattern of microorganisms, and previous experience of treatment.

Specific antibacterial therapy — therapy with antimicrobials against the causative agent of infection. It is based on isolation and identification of the microorganisms from the patient and antimicrobial susceptibility testing of the isolates.

Sources of antibiotics. Spectrum of action. Chemical classification of antibiotics.

Antibiotic — antimicrobials of biological origin, most of which are produced by fungi or by bacteria of the genus *Streptomyces*, displaying “selective toxicity” and inhibiting or destroying bacteria at very low concentration without causing damage to the macroorganism.

Characteristics of the ideal antimicrobial drug:

- Selectively toxic to the microbe but nontoxic to host cells;

- Microbicidal rather than microbistatic;
- Relatively soluble and functions even when highly diluted in body fluids;
- Remains potent long enough to act and is not broken down or excreted prematurely;
- Not subject to the development of antimicrobial resistance;
- Complements or assists the activities of the host's defenses;
- Remains active in tissues and body fluids;
- Readily delivered to the site of infection;
- Not excessive in cost;
- Does not disrupt the host's health by causing allergies or predisposing the host to other infections.

I. Classification of antibiotics by effects on microbial cells:

- 1. Bactericidal** — antimicrobials lethal to bacteria.
- 2. Bacteriostatic** — antimicrobials inhibiting the growth of bacteria.

II. Classification of antibiotics by spectrum of action:

1. **Narrow-spectrum.** A narrow-spectrum agent has activity against a limited array of different microbial types. Examples are bacitracin, an antibiotic whose inhibitory effects extend mainly to certain gram-positive bacteria, or griseofulvin, which is used chiefly in fungal skin infections.

2. **Broad-spectrum or extended-spectrum.** These agents display activity against a wider range of different microbes. The targets of antibiotics in the tetracycline group, for example, are a variety of gram-positive and gram-negative bacteria, rickettsias, mycoplasmas.

III. Classification of antibiotics by sources of antimicrobial agents:

1. Antimicrobials of biological origin which are produced by:
 - microorganisms: bacteria, *Streptomyces spp.*, fungi;
 - animals;
 - plants;
2. Chemically modified biological antibiotics.
3. Chemically synthesized biological antibiotics.

IV. Classification of antibiotics by chemical structure:

1. β -lactam antibiotics

1.1. Penicillins:

- 1.1.1. **Classic penicillins:** penicillin G (benzyl penicillin), penicillin V (oral penicillin), pheneticillin, propicillin;
- 1.1.2. **Penicillinase-resistant penicillins:** methicillin, oxacillin, cloxacillin, flucloxacillin;
- 1.1.3. **Aminopenicillins:** ampicillin, amoxicillin, epicillin, hetacillin, etc.;
- 1.1.4. **Carboxyl penicillins:** carbenicillin, ticarcillin, carfecillin, etc.;
- 1.1.5. **Acylureidopenicillins:** azlocillin, mezlocillin, piperacillin, apalcillin.

1.2. Cephalosporins:

- 1.2.1. Group 1: cefazolin, cephalothin;
- 1.2.2. Group 2: cefuroxime, cefotiam, cefamandole;
- 1.2.3. Group 3a: cefotaxime, ceftriaxone, ceftizoxime, cefmenoxime, cefodizime;
- 1.2.4. Group 3b: Ceftazidime, cefepime, ceftiofime, cefoperazone;
- 1.2.5. Further cephalosporins: cefsulodin, cefoxitin;
- 1.2.6. Oral cephalosporins: cefaclor, cefadroxil, cephalixin, cefradinecefopodoxime, cefuroxime (axetil), cefixime, cefprozil, cefdinir, cefetamet, cefibuten.

1.3. **Monobactams:** aztreonam, carumonam.

1.4. **Penems:** imipenem, meropenem.

- 1.5. **Carbacephems betalactams:** loracarbef.
- 1.6. **Oxalactams betalactam:** lamoxactam, flomoxef.
2. **Aminoglycoside antibiotics:** streptomycin, neomycin, kanamycin, gentamicin, tobramycin, amikacin, netilmicin, sisomicin, spectinomycin.
3. **Macrolides/ketolides:** erythromycin, roxithromycin, clarithromycin, azithromycin, telithromycin.
4. **Tetracyclines:** doxycycline, tetracycline, oxytetracycline, rolitetracycline, minocycline.
5. **Lincosamide:** lincomycin, clindamycin.
6. **Glycopeptides:** vancomycin, teicoplanin.
7. **4-Quinolones:** norfloxacin, pefloxacin, ciprofloxacin, ofloxacin, fleroxacin, enoxacin, levofloxacin, sparfloxacin, gatifloxacin, moxifloxacin.
8. **Polypeptides:** bacitracin.
9. **Polymyxin B, colistin.**
10. **Chloramphenicol.**
11. **Rifamycins:** rifampicin, rifamycin.
12. **Streptogramins:** quinopristin/dalfopristin.
13. **Oxazolidinones:** linezolid.
14. **Ethambutol.**
15. **Fosfomycin.**
16. **Fusidic acid.**
17. **Isonicotinamides:** isoniazid.
18. **Para-aminosalicylic acid.**
19. **Nitrofurans:** nitrofurantoin, furazolidone, nitrofurazone, etc.
20. **Nitroimidazoles:** metronidazole, tinidazole, ornidazole
21. **Sulfamethoxazole/trimethoprim (cotrimoxazole).**
22. **Sulfonamides:** sulfamethoxazole, sulfafurazole, etc.
23. **Sulfones:** dapsone.

Mechanisms of action. Side effects. Principles for rational antimicrobial therapy.

Mechanisms of action of antimicrobial drugs:

An ideal antimicrobial agent exhibits selective toxicity, achieved by the action of antimicrobials to the targets unique only to bacteria. The mechanisms of action of antimicrobials are following:

1. Inhibition of cell wall synthesis. Bacteria have a rigid outer layer, the cell wall, consisting of unique to bacteria peptidoglycan formed by *N*-acetylglucosamine and *N*-acetylmuramic acid. Mature peptidoglycan is held together by cross-linking of short peptide side chains hanging of the long glycan molecules. The transpeptidation reactions that seal the peptide crosslinks between glycan chains is the target of two of the most important groups of antimicrobics, the β -lactams and the glycopeptides (vancomycin and teicoplanin). Injury to the cell wall or inhibition of its formation may lead to lysis of the cell. Bacitracin, ristocetin and novobiocin also inhibit early steps in the biosynthesis of the peptidoglycan.

2. Inhibition of cell membrane function. Cytoplasmic membrane serves as a selective permeability barrier, carries out active transport functions, and thus controls the internal composition of the cell. If the functional integrity of the cytoplasmic membrane is disrupted, macromolecules and ions escape from the cell, and cell damage or death ensues. Samples of agents acting by inhibition of cell membrane function are amphotericin B, colistin, the imidazoles and triazoles, the polymyxins, daptomycin.

3. Inhibition of protein synthesis (i.e., inhibition of translation and transcription of genetic material). Bacteria have 70S ribosomes, whereas mammalian cells have 80S ribosomes. The subunits of 70S ribosomes can be the targets for following antimicrobials: 1) aminoglycosides; 2) macrolides, azalides, ketolides; 3) lincomycins; 4) tetracyclines; 5) glycylicyclines; 6) chloramphenicol; 7) streptogramins; 8) oxazolidinones.

4. Inhibition of nucleic acid synthesis. Examples of the drugs acting by inhibition of nucleic acid synthesis are the quinolones, pyrimethamine, rifampin, sulfonamides, trimethoprim, and trimetrexate.

Inhibition of DNA gyrase. DNA gyrase only occurs in bacteria, catalyzes the counter-clockwise supercoiling of the double helix. DNA replication depends on this supercoiled topology. Quinolones and fluoroquinolones inhibit DNA gyrase, the latter also inhibits bacterial topoisomerase.

Inhibition of DNA-dependent RNA polymerase. By binding strongly to the DNA-dependent RNA polymerase rifampin inhibits RNA synthesis and bacterial growth. Rifampin resistance results from a change in RNA polymerase due to a chromosomal mutation that occurs with high frequency.

5. Inhibition of metabolic pathway: sulfonamides, folic acid analogues. *P*-aminobenzoic acid (PABA) is an essential metabolite involved in the synthesis of folic acid. PABA condensate with a pteridine resulting in dihydropteroic acid formation, which is subsequently converted to folic acid. Sulfonamides are structural analogs of PABA and competitively inhibit dihydropteroate synthetase.

Side effects:

1. **Toxic effects.** These effects arise from direct cell and tissue damage in the macroorganism. Antibiotics of several groups can impair the function of the liver (hepatotoxic), kidneys (nephrotoxic), gastrointestinal tract, cardiovascular system and blood-forming tissue (hemotoxic), nervous system (neurotoxic), respiratory tract, skin, bones, and teeth.

2. **Allergic reactions.** Mild allergic reactions consist of an itchy rash or slight wheezing. Severe allergic reactions (anaphylaxis) can be life-threatening and usually include swelling of the throat, inability to breathe, and low blood pressure.

3. **Biological side effects.** Change in or elimination of beneficial normal flora. Usage of broad spectrum antibiotics may result in dysbacteriosis. Some people who take antibiotics, especially cephalosporins, clindamycin, or fluoroquinolones, develop *Clostridium difficile* — induced colitis, an inflammation of the large intestine.

4. **Indirect immunosuppression.**

5. **Development of resistance to antimicrobials in microorganisms.**

The problem of resistance to antimicrobials: definitions (intrinsic, acquired resistance), incidence, significance. Resistance mechanisms: non-genetic and genetic origin of drug resistance. Biochemical resistance. Beta-lactamases. Evolution of resistance to anti-infective agents.

Microbes (the collective term for bacteria, fungi, parasites, and viruses) cause infectious diseases, and antimicrobial agents, such as penicillin, streptomycin, and more than 150 others, have been developed to combat the spread and severity of many of these diseases. Resistance to antimicrobials is a natural biological phenomenon that can be amplified or accelerated by a variety of factors, including human practices.

In September 2001, WHO launched the first global strategy for combating the serious problems caused by the emergence and spread of antimicrobial resistance. Known as the WHO Global Strategy for Containment of Antimicrobial Resistance, the strategy recognizes that antimicrobial resistance is a global problem that must be addressed in all countries.

Definitions:

Natural (*intrinsic* , inherent) resistance — exists naturally and is not acquired through specific genetic changes. The microorganisms had never formerly been sensitive to the drug. The resistant species have features such as permeability barriers, a lack of susceptibility of the cell wall, or ribosomal targets that make them inherently insusceptible. Bacteria such as streptococci, enterococci, and anaerobes, which lack the necessary oxidative pathways for transport of aminoglycosides, are resistant

Acquired resistance — when an initially susceptible species develops resistance, such acquired resistance can be mutational or derived from another organism by the acquisition of new genes using one of the mechanisms of genetic exchange.

Minimal inhibitory concentration (MIC) — the lowest concentration (mkg/mL) of the antibiotic able to inhibit visible growth of the microorganism. The basic quantitative measures of the in vitro activity of antibiotics are the minimum inhibitory concentration (MIC).

Resistant — microorganisms that are not inhibited by clinically achievable concentrations of an antimicrobial agent.

Intermediate resistant — isolates for which response rates to clinically achievable concentrations of antimicrobial agents may be lower than for susceptible isolates.

Susceptible — microorganisms inhibited by dosages of the antimicrobials recommended for that type of infection and infecting species.

Vertical evolution of resistance — acquired resistance that develops due to chromosomal mutation and selection.

Horizontal evolution of resistance — acquired resistance that develops due to the acquisition of new genetic material from other resistant organisms of the same species or other genera by mechanisms of genetic exchange including conjugation, transduction, and transformation.

Cross-resistance — resistance to multiple related antimicrobial agents via a single mechanism of resistance.

Multiple resistance — resistance to unrelated antimicrobial agents via different mechanisms of resistance.

Mechanisms of resistance:

1. **Altered permeability of the bacteria to an antimicrobial agent.** Altered permeability may be due to the inability of the antimicrobial agent to enter the bacterial cell or alternatively to the active export of the agent from the cell (efflux):

Reduced influx. Reduction of transport of anti-infective agents from outside to inside through membranes; rare. For example, strains of *Pseudomonas aeruginosa* commonly develop resistance to imipenem due to loss of the outer membrane protein (OMP) most important in its penetration.

Increased efflux. Active transport of anti-infective agents from inside to outside by means of efflux pumps in the cytoplasmic membrane, making efflux greater than influx; frequent.

2. **Inactivation of the antimicrobial agent by an enzyme produced by the microorganism.** Resistance is often the result of the production of an enzyme that is capable of inactivating the antimicrobial agent.

Betalactamases. Hydrolyze the betalactam ring of betalactam antibiotics. Over 200 different betalactamases are known that are classified according to substrate profile: penicillinases, cephalosporinases, broad spectrum betalactamases, extended spectrum betalactamases.

Aminoglycosidases. Modify aminoglycosides by means of phosphorylation and nucleotidylation of free hydroxyl groups (phosphotransferases and nucleotidyl transferases) or acetylation of free amino groups (acetyltransferases).

Chloramphenicol acetyltransferases. Modification, by acetylation, of chloramphenicol.

3. **Alterations of antimicrobial target site.** Most drugs act on a specific target such as protein, RNA, DNA, or membrane structure, microbes can circumvent drugs by altering the nature of this target. In mycobacteria resistant to rifampin the structure of key protein — RNA polymerase — has been altered so that this antibiotic can no longer bind.

4. **Replacement of a sensitive pathway.** Resistance can result from the acquisition of a new enzyme to replace the sensitive one. Sulfonamide (antimetabolites) and trimethoprim resistance develops when microbes deviate from the usual patterns of folic acid synthesis. Fungi can acquire resistance to flucytosine by completely shutting off certain metabolic activities.

Principles of resistance control:

1. Use antimicrobials conservatively and specifically in therapy.
2. Use an adequate dosage and duration of therapy to eliminate the infecting organism and reduce the risk of selecting resistant variants.
3. Select antimicrobials according to the proved or anticipated known susceptibility of the infecting strain whenever possible.
4. Use narrow-spectrum rather than broad-spectrum antimicrobials when the specific etiology of an infection is known, if possible.
5. Use combinations of antimicrobials when they are known to prevent emergence of resistant mutants.
6. Use antimicrobials prophylactically only in situations in which it has been proven valuable and for the shortest possible time to avoid selection of a resistant flora.
7. Avoid environmental contamination with antimicrobials.
8. Use containment isolation procedures for patients infected with resistant organisms that pose a threat to others, and use protective precautions for those who are highly susceptible.
9. Epidemiologically monitor resistant organisms or resistance determinants in an institution and apply enhanced control measures if a problem develops.
10. Restrict the use of therapeutically valuable antimicrobials for nonmedical purposes.

Antibiotic susceptibility testing of microorganisms: methods and principles. Minimal inhibitory concentration. Procedures of agar and broth dilution tests and Kirby–Bauer agar disk diffusion test.

The results of *in vitro* antibiotic susceptibility testing, guide clinicians in the appropriate selection of antimicrobial regimens. In selecting therapy, the results of laboratory tests cannot be considered by themselves, but must be examined with information about the clinical pharmacology of the agent, the cause of the disease, the site of infection, and the pathology of the lesion. These factors must all be taken into account when selecting the appropriate antimicrobial from those to which the organism has been reported as susceptible. *In-vitro* antibiotic susceptibility testing is performed according to international methods developed by NCCLS and other organizations.

NCCLS is an international, interdisciplinary, non-profit, non-governmental organization composed of medical professionals, government, industry, healthcare providers, educators etc. It promotes accurate antimicrobial susceptibility testing (AST) and appropriate reporting by developing standard reference methods, interpretative criteria for the results of standard AST methods, establishing quality control parameters for standard test methods, provides testing and reporting strategies that are clinically relevant and cost-effective

Methods of the antibiotic susceptibility testing:

Antimicrobial susceptibility testing methods are divided into types based on the principle applied in each system:

1. Molecular methods.

2. Phenotypic methods:

Diffusion methods, or Kirby-Bauer method;

Dilution methods (in broth or agar media) or minimum inhibitory concentration detection tests;

Combined methods — diffusion & dilution — E-test;

Automatic method.

Steps in antibiotic susceptibility testing:

1. Isolation of pure culture from biological specimen and preparation of the microbial suspension.

2. Preparation of media with dilutions of antibiotics.
3. Inoculation of the media with microbial inoculums.
4. Incubation.
5. Registration of results, analysis, recommendations on treatment of the infection.
6. Periodical quality control of susceptibility testing.

Dilution tests. Dilution tests determine the MIC directly by using two-fold serial dilutions of the antimicrobials in broth or agar media (Fig. 9.1). The two-fold serial dilutions of antibiotics are prepared in tubes with broth (0.25, 0.5, 1, 2, 4, 8 and so on). The bacterial inoculum is adjusted to a concentration of 10^5 to 10^6 CFU/ml and added to the broth. After incubation overnight, the tubes are examined for turbidity produced by bacterial growth. The first tube in which visible growth is absent (clear) is the MIC for that organism. If each broth is 0.2 ml or less the process may be called a *microdilution broth test*; otherwise it is a *macrodilution broth test*.

In the *agar dilution test* a series of agar plates containing progressively lower concentrations of a given antibiotic (and an antibiotic-free control plate) are each surface inoculated with the test organism and incubated; the MIC is indicated by the lowest concentration of antibiotic at which growth does not occur.

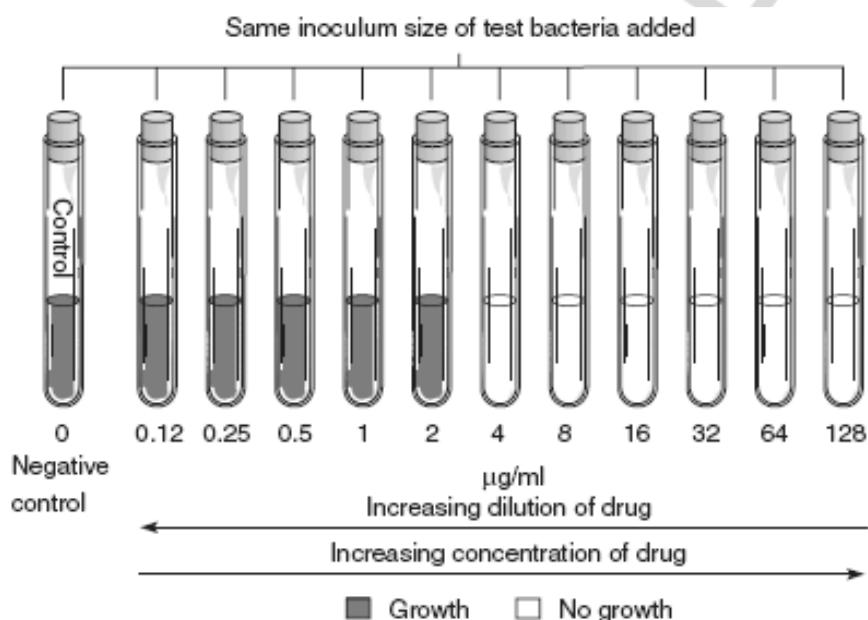

Figure 9.1. Broth dilution test allows detecting MICs

Diffusion tests. In clinical laboratories a more common test for antibiotic susceptibility testing. It is semi quantitative method which detects active antibiotics against test-microorganisms but not MICs.

Principle. The inoculum is seeded onto the surface of an agar plate, then disks of filter paper containing the anti-infective agents are placed on the agar. While the plates are incubating, the antimicrobial diffuses into the medium to produce a circular gradient around the disk. After incubation overnight, the size of the zone of growth inhibition around the disk can be used as an indirect measure of the MIC of the organism.

Procedure. The inoculum is prepared by making a direct broth or saline suspension of isolated colonies selected from a 18- to 24-hour agar plate. The suspension is adjusted to match the 0.5 McFarland turbidity standard, using saline and a vortex mixer. A sterile cotton swab is dipped into the adjusted suspension and excess inoculum from the swab is to be removed. The dried surface of a Müller-Hinton agar plate is inoculated by streaking the swab over the entire sterile agar surface. The predetermined battery of antimicrobial discs is dispensed onto the surface of the inoculated agar plate. Each disc must be pressed down to ensure complete contact with the agar

surface. The discs must be distributed evenly so that they are no closer than 24 mm from center to center. Ordinarily, no more than 5 discs should be placed on one 100 mm plate. The plates are inverted and placed in an incubator set to 35 °C. After 16 to 18 hours of incubation, each plate is examined. The diameters of the zones of complete inhibition are measured, including the diameter of the disc.

Evaluation of the results. If the zone of inhibition is equal to or greater than the interpretive standard for susceptible organisms, the organism is considered to be sensitive to the antibiotic. If the zone of inhibition is equal or less than the interpretive standard for resistant organisms, the organism is considered to be resistant. If the zone of inhibition is greater than for resistant microorganisms and less than for susceptible, the organism is considered to be intermediate resistant.

Automated tests. Workstations are now available that carry out rapid, automated identification and susceptibility testing of microorganisms. In these systems the bacteria are incubated with the antimicrobial in specialized modules that are read automatically every 1–2 hours. The multiple readings and registration of growth by turbidimetric or urometric analysis make it possible to generate MICs in as little as 4 hours. These methods are no more expensive than manual methods. Computerized results can be used in the interhospital monitoring systems (Fig. 9.2).



Figure 9.2. Vitek 60 (bioMérieux, France) automated system for identification and susceptibility testing to antimicrobials of microorganisms

Molecular tests. The molecular techniques of nucleic acid hybridization, sequencing, and amplification are applied to the detection and study of resistance. These methods allow to detect resistance genes or mutation in genes associated with the resistance. These methods offer the prospect of automation and rapid results. The system comprises a predefined antibiotic gradient which is used to determine the Minimum Inhibitory Concentration (MIC), in $\mu\text{g/mL}$, of different antimicrobial agents against microorganisms as tested on agar media using overnight incubation.

Diffusion and dilution test. E-test is a quantitative technique for determining the antimicrobial susceptibility. The E-test gradient technology is based on a combination of the concepts of dilution and diffusion principles for susceptibility testing. Etest is a thin, inert and non-porous plastic strip. One side of the strip (A) carries the MIC reading scale in $\mu\text{g/mL}$ and a two or three-letter code on the handle to designate the identity of the antibiotic. A predefined exponential gradient of antibiotic, dried and stabilized, is immobilised on the other surface of the strip (B) with the concentration maximum on the top of the strip and minimum on the bottom. After inoculation of the medium with test-microorganism E-test strips are placed on the agar. Each E-test must be pressed down

to ensure complete contact with the agar surface. Maximum two or six strips can be placed on Petri dish with diameter 90 or 150 mm correspondingly. Antibiotic diffuses to agar forming an ellipsoid zone of growth inhibition. After incubation for 16–8 hours at 35 °C growth/inhibition edge indicates MIC for a particular antibiotic (Fig. 9.3).

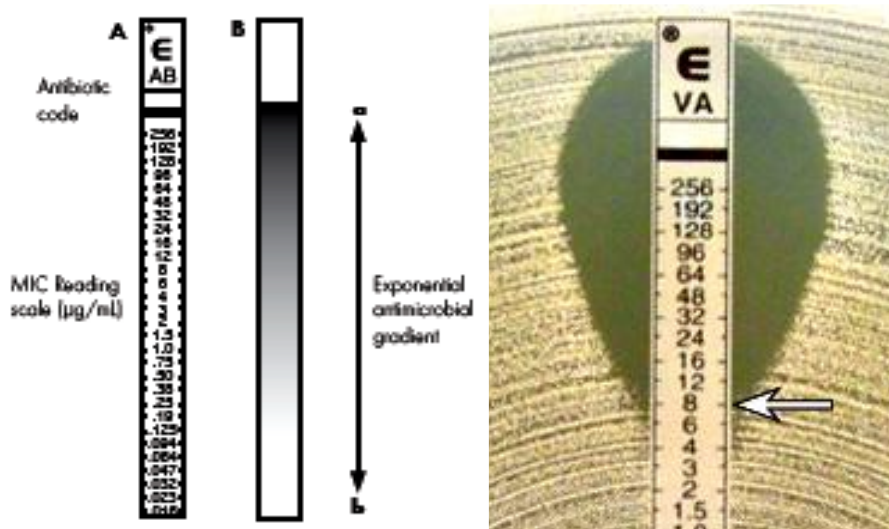
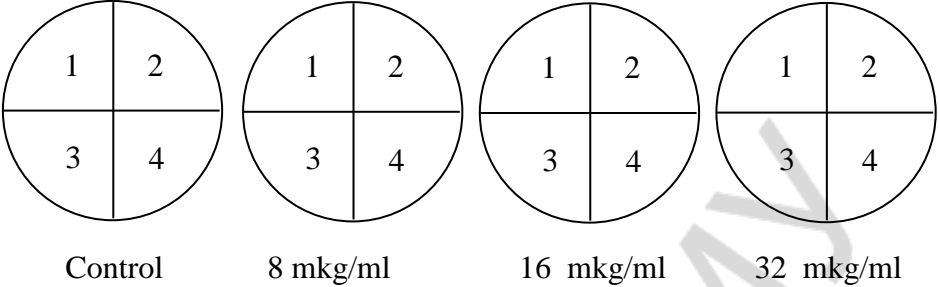
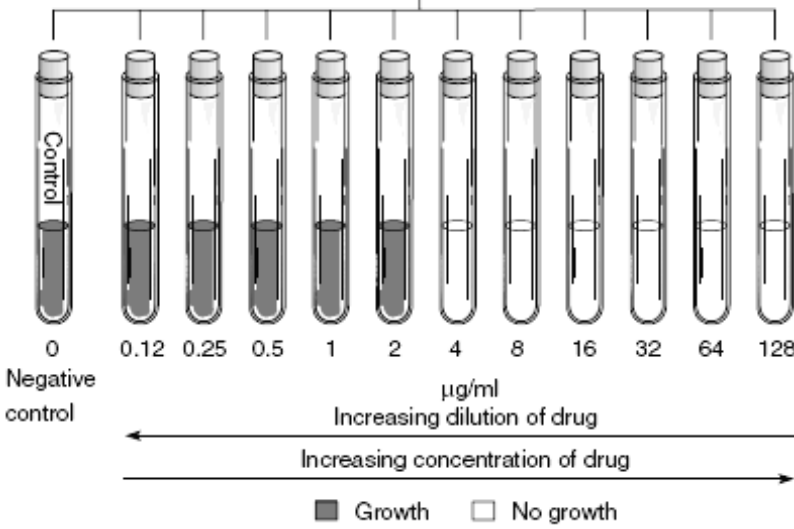

Figure 9.3. E-test is plastic strip with exponential gradient of antibiotic which diffuse to agar to produce an ellipsoid zone of growth inhibition

Class 9. Practical part

Date _____

| Laboratory exercises | Laboratory report |
|---|---|
| <p>1. Perform the disk diffusion method (Kirby–Bauer) for determination of antibiotic susceptibility of four different microorganisms which often infect humans — <i>Staphylococcus aureus</i>, <i>Escherichia coli</i>, <i>Pseudomonas aeruginosa</i> and <i>Klebsiella pneumoniae</i></p> | <div style="text-align: center;"> <p>Müeller–Hinton agar application of antimicrobial discs onto the surface of the inoculated agar plate</p> <p>Müeller–Hinton agar (composition): meat extract — 2,0 g; Casein hydrolysate — 17,5 g; Corn starch — 1,5 g; Agar — 17,0 g; Aqua distillate — 1 l; pH 7,4±0,2</p> </div> |

| Laboratory exercises | Laboratory report | | | | | | | | | | | | | | | | | | | | | | | | | | |
|---|--|---------------------------|-------------|--|--|-----------|------------------------|-------------|------------|------|----|-----|-------------------|-------------|---------------------------|-------------|--|--|-------------|--|--|-------------|--|--|-------------|--|--|
| 2. Determine antibiotic susceptibility of micro-organisms by agar dilution test. Complete the report |  <p style="text-align: center; margin-top: 10px;">Petri dishes with the serial doubled dilutions of ampicillin in agar media</p> <p style="text-align: center; margin-top: 10px;">Interpretation of results</p> <table border="1" style="margin: 0 auto; border-collapse: collapse; text-align: center;"> <thead> <tr> <th rowspan="2" style="padding: 5px;">Antibiotic</th> <th colspan="3" style="padding: 5px;">MIC, mkg/ml</th> </tr> <tr> <th style="padding: 5px;">resistant</th> <th style="padding: 5px;">intermediate resistant</th> <th style="padding: 5px;">susceptible</th> </tr> </thead> <tbody> <tr> <td style="padding: 5px;">Ampicillin</td> <td style="padding: 5px;">≥ 32</td> <td style="padding: 5px;">16</td> <td style="padding: 5px;">≤ 8</td> </tr> </tbody> </table> <p style="text-align: center; margin-top: 10px;">Results registration and interpretation</p> <table border="1" style="margin: 0 auto; border-collapse: collapse; width: 100%;"> <thead> <tr> <th style="padding: 5px;">Microbial culture</th> <th style="padding: 5px;">MIC, mkg/ml</th> <th style="padding: 5px;">Interpretation of results</th> </tr> </thead> <tbody> <tr> <td style="padding: 5px;">Culture № 1</td> <td style="padding: 5px;"></td> <td style="padding: 5px;"></td> </tr> <tr> <td style="padding: 5px;">Culture № 2</td> <td style="padding: 5px;"></td> <td style="padding: 5px;"></td> </tr> <tr> <td style="padding: 5px;">Culture № 3</td> <td style="padding: 5px;"></td> <td style="padding: 5px;"></td> </tr> <tr> <td style="padding: 5px;">Culture № 4</td> <td style="padding: 5px;"></td> <td style="padding: 5px;"></td> </tr> </tbody> </table> <p style="margin-top: 10px;">Conclusion about advantage of dilution method _____</p> <p>_____</p> <p>_____</p> | Antibiotic | MIC, mkg/ml | | | resistant | intermediate resistant | susceptible | Ampicillin | ≥ 32 | 16 | ≤ 8 | Microbial culture | MIC, mkg/ml | Interpretation of results | Culture № 1 | | | Culture № 2 | | | Culture № 3 | | | Culture № 4 | | |
| Antibiotic | MIC, mkg/ml | | | | | | | | | | | | | | | | | | | | | | | | | | |
| | resistant | intermediate resistant | susceptible | | | | | | | | | | | | | | | | | | | | | | | | |
| Ampicillin | ≥ 32 | 16 | ≤ 8 | | | | | | | | | | | | | | | | | | | | | | | | |
| Microbial culture | MIC, mkg/ml | Interpretation of results | | | | | | | | | | | | | | | | | | | | | | | | | |
| Culture № 1 | | | | | | | | | | | | | | | | | | | | | | | | | | | |
| Culture № 2 | | | | | | | | | | | | | | | | | | | | | | | | | | | |
| Culture № 3 | | | | | | | | | | | | | | | | | | | | | | | | | | | |
| Culture № 4 | | | | | | | | | | | | | | | | | | | | | | | | | | | |
| 3. Determine antibiotic susceptibility of micro-organisms by broth dilution test, complete the report | <p style="margin-bottom: 5px;">Same inoculum size of test bacteria added</p>  <p style="margin-top: 10px;">Report: minimal inhibitory concentration of antibiotic is _____ µg/ml.</p> | | | | | | | | | | | | | | | | | | | | | | | | | | |

| Laboratory exercises | Laboratory report | | |
|---|---|--|----------------------------------|
| 4. Determine antibiotic susceptibility of microorganisms by disk diffusion method, complete the report (perform it at classes № 10). | Results of pure culture _____ testing by disc diffusion method | | |
| Demonstration: 1. Agar disk diffusion test for antibiotic susceptibility testing of microorganisms. 2. Rapid test for antibiotic susceptibility testing of microorganisms. 3. Slide of <i>Bacillus anthracis</i> in tissues of white mouse, Gram stain. | Antibiotic | Diameter of inhibition zone, mm | Interpretation of results |
| | | | |
| | | | |
| | | | |
| | | | |
| | | | |
| | | | |
| | | | |
| | | | |
| | | | |
| Report (formulate what antibiotics can be recommended for the therapy): _____ | | | |
| Interpretation of inhibition zones of test cultures (mm) | | | |
| Antibiotic | Interpretative standard diameter of inhibition zones (mm) | | |
| | resistant | intermediate resistant | susceptible |
| <i>Staphylococcus spp.</i> | | | |
| Penicillin | ≤28 | – | ≥29 |
| Oxacillin | ≤10 | 11–12 | ≥13 |
| <i>S. aureus</i> | ≤17 | – | ≥18 |
| CNS | ≤12 | 13–14 | ≥15 |
| Gentamicin | ≤15 | 16–20 | ≥21 |
| Ciprofloxacin | ≤14 | 15–18 | ≥19 |
| Tetracycline | ≤13 | 14–22 | ≥23 |
| Erythromycin | <17 | 17–20 | ≥21 |
| Clindamycin | ≤12 | 13–17 | ≥18 |
| Chloramphenicol | <i>Enterobacteriaceae</i> | | |
| Ampicillin | ≤13 | 14–16 | ≥17 |
| Cefazolin | ≤14 | 15–17 | ≥18 |
| Cefotaxime | ≤14 | 15–22 | ≥23 |
| Gentamicin | ≤12 | 13–14 | ≥15 |
| Ciprofloxacin | ≤15 | 16–20 | ≥21 |
| Lomefloxacin | ≤18 | 19–21 | ≥22 |
| Tetracycline | ≤14 | 15–18 | ≥19 |
| Doxicycline | ≤12 | 13–15 | ≥16 |
| Chloramphenicol | ≤12 | 13–17 | ≥18 |
| Signature of the tutor _____ | | | |

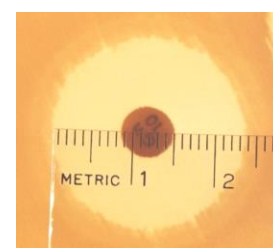
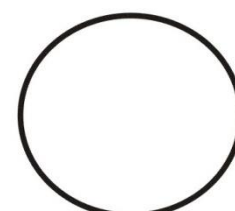

Figure 9.4. Measurement of growth inhibition zone



Smear _____

Stain _____

Practical class 10

CREDIT 1 “MORPHOLOGY AND PHYSIOLOGY OF MICROORGANISMS. INFECTION”

List of questions for a concluding session:

1. History of microbiology as a science. Periods. The founders of main routes of microbiology.
2. Microscopic method of examination: tasks, procedure, evaluation of the method.
3. Bright-field light microscope: components and proper use of the microscope. Dark-field light microscopy: the principle behind dark-field microscopy. Phase-contrast light microscope: basic principles behind phase-contrast microscopy. Fluorescence microscopy: principles behind the fluorescence microscopy. The technique of oil immersion microscopy.
4. Type of microscopic preparations. Smear preparation and fixation. Simple methods of staining.
5. Differential stains of microorganisms. Gram stain: medical application, principles, procedure for Gram stain.
6. Basic bacterial cell structure: components of bacterial cell. Morphology of bacteria. Distinctive features of prokaryotic and eukaryotic cells. Basic morphological forms of bacteria. Morphological characteristics of cocci, rods and spiral-shaped bacteria.
7. Structure and function of cell envelope and appendages. Capsule. Detection methods of the capsule.
8. The composition, function, detection methods of bacterial cell wall. The structure of murein (syn. peptidoglycan). The cell wall of gram-positive bacteria. The cell wall of gram-negative bacteria. Bacterial forms with defective cell wall. Factors inducing cell wall removal, medical importance of L-forms.
9. Bacterial core: cytoplasm, cytoplasmic structures; their functions and detection methods. Acid-fast bacteria and unique properties of their cell wall. Methods of acid-fast staining: medical application, principle, procedure.
10. Resting forms of microorganisms. Bacterial endospores: medical importance, properties of endospore, the stages of endospore formation, detection methods (principles, procedures).
11. Motility of bacteria, methods of detection.
12. Taxonomy of microorganisms: classification and nomenclature. Modern approaches to taxonomy of microorganisms. Taxonomic ranks. Vars (types), strains, clones, pure cultures.
13. Taxonomy, morphology, medical significance of the spirochetes. Methods for spirochetes detection.
14. Taxonomy, morphology, medical significance of Actinomycetes.
15. Taxonomy, morphology, medical significance of Mycoplasmas. Methods for Mycoplasmas investigations.
16. Taxonomy, morphology, medical significance of Chlamydiae.
17. Nutrition of microorganisms. Source of macro- and micronutrients, growth factors. Nutritional types. Transport mechanisms for nutrient absorption.
18. Energy strategies in microorganisms. Aerobic and anaerobic respiration. Structures involved in respiration in microorganisms.
19. Reproduction of microorganisms. Mechanisms and phases of bacterial division.
20. Bacteriological method of laboratory diagnosis: tasks, procedure, evaluation of the method.
21. Cultivation of microorganisms. Conditions required for growth. Nutrient media for culturing bacteria: classification and characteristics. Culture media ingredients, procedure of preparation and sterilization. General requirements to bacteriologic nutrient media.
22. Methods of isolation of aerobic microorganisms in pure culture.
23. Methods of isolation of anaerobic microorganisms in pure culture. Cultivation of anaerobic bacteria: culture media, techniques, equipment.
24. Identification of microorganisms: morphological, cultural, serologic, biological, genetic.

25. Biochemical identification of microorganisms. Detection of: a) proteolytic enzymes; b) carbohydrate hydrolyses enzymes; c) lipolytic enzymes; d) oxidative-reductive enzymes; e) hemolysins. Automatic stations for identification of bacteria.
26. The structure of bacterial genetic apparatus. Phenotype, genotype, genome, genes. Regulation of gene expression. General properties and varieties of plasmids. Detection of plasmids. Mobile genetic elements: transposons and IS elements.
27. Bacterial variability: phenotypic and genetic. Practical significance of bacterial variability. Population variability.
28. Mechanisms of genetic variability: mutations and recombinations. Classification of mutations. Methods of mutant bacteria selection. Horizontal gene transfer: transformation, transduction, conjugation. Genomics. Bioinformatics. Genetic engineering. Gene Cloning.
29. Molecular methods in diagnosis of infection diseases: aims, methods, advantages. Molecular hybridization and polymerase chain reaction: principles of the methods. Equipment for PCR and hybridization. DNA extraction.
30. Doctrine regarding infections. Terms for emergence of infectious disease. Basic terminology of infectology. Classification of infections.
31. Role of microorganisms in infection emergence. Bacterial pathogenicity and virulence. Measurements of virulence: ID₅₀, LD₅₀, DLM. The genetics of bacterial pathogenicity. Pathogenicity islands. Pathogenicity factors: adhesins, invasins, impedins, aggressins, modulins.
32. Role of macroorganism, social and physical factors in infection emergence.
33. Evolution of microorganisms and infection diseases.
34. Biological method (application of laboratory animals in microbiology): tasks, phases, evaluation of the method. Animal models for infection diseases. Routs for laboratory animal infection. Ethical, humane and legal considerations involved in the use of laboratory animals.
35. Chemoprophylaxis and chemotherapy; antimicrobial chemotherapeutic agents and antibiotics. Sources of antibiotics. Spectrum of action. Chemical classification of antibiotics.
36. Mechanisms of action of antibiotics.
37. Side effects of antibiotics. Principles for rational antimicrobial therapy.
38. The problem of resistance to antimicrobials: definitions (intrinsic, acquired resistance), incidence, significance. Resistance mechanisms: non-genetic and genetic origin of drug resistance. Biochemical resistance.
39. Evolution of resistance to anti-infective agents. Antibiotic susceptibility testing of microorganisms: methods and principles.
40. Ecology of microorganisms. Basic terminology of ecology. Interspecific and intraspecific relations. Symbiosis, its variants. Antagonistic microbial relationships, its background and medical importance. Bacteriocins.
41. Diversity of normal flora at different sites of human body. Origin of the normal flora. Beneficial effects of the normal flora. Methods of normal flora investigation. Gnotobiology. Dysbacteriosis: aetiology, pathogenesis, symptoms, approaches to treatment, prophylaxis.
42. Sterilization: definition, methods of sterilization (physical, chemical, mechanical), quality control.
43. Disinfection: definition, methods of disinfection.
44. Antisepsis: definition, methods of antisepsis. Disinfectant and antiseptics: classification and modes of action.
45. Asepsis: definition, surgical, medical asepsis, asepsis in microbiological laboratory.

BIBLIOGRAPHY FOR SELF-STUDY

Base

1. *Generalov, I. I.* Medical microbiology, virology & immunology : lecture course for students of medical universities / I. I. Generalov. Vitebsk : VSMU, 2016. P. I. 282 p.

Additional

2. *Medical microbiology* / F. H. Kayser [et al.]. Thieme, Stuttgart, New York, 2005. 725 p.

3. *Ryan, K. J.* Sherris medical microbiology. An introduction to infectious diseases / K. J. Ryan, C. G. Ray, J. C. Sherris. 4th ed. McGraw-Hill Medical Publishing Division, 2010. 979 p.

4. *Murray, P. R.* Medical microbiology / P. R. Murray, K. S. Rosenthal, M. A. Pfaller. Elsevier Health Sciences, 2015. 789 p.

5. *Washington, J. A.* Laboratory procedures in clinical microbiology / J. A. Washington. Springer Science & Business Media, 2012.

6. *Molecular genetics of bacteria* / L. Snyder [et al.]. American Society of Microbiology, 2013.

7. *McPherson, R. A.* Henry's clinical diagnosis and management by laboratory methods / R. A. McPherson, M. R. Pincus. Elsevier Health Sciences, 2016.

8. *Gillespie, S. H.* Medical microbiology illustrated / S. H. Gillespie. Butterworth-Heinemann, 2014.

Учебное издание

Слизень Вероника Вячеславовна
Кирильчик Елена Юрьевна
Шабан Жанна Георгиевна и др.

ОБЩАЯ МИКРОБИОЛОГИЯ

GENERAL MICROBIOLOGY

Лабораторный практикум

На английском языке

3-е издание

Ответственная за выпуск Т. А. Канашкова
Переводчик В. В. Слизень
Компьютерная вёрстка Н. М. Федорцовой

Подписано в печать 23.12.20. Формат 60 84/8. Бумага «Discovery».
Ризография. Гарнитура «Times».
Усл. печ. л. 9,3. Уч.-изд. л. 6,51. Тираж 243 экз. Заказ 22.

Издатель и полиграфическое исполнение: учреждение образования
«Белорусский государственный медицинский университет».
Свидетельство о государственной регистрации издателя, изготовителя,
распространителя печатных изданий № 1/187 от 18.02.2014.
Ул. Ленинградская, 6, 220006, Минск.