

D. A. CHARNASHEY, V. V. SLIZEN, T. A. KANASHKOVA

IMMUNOLOGY

Laboratory workbook

Student name _____

Faculty _____

Group _____

Minsk BSMU 2022

МИНИСТЕРСТВО ЗДРАВООХРАНЕНИЯ РЕСПУБЛИКИ БЕЛАРУСЬ
БЕЛОРУССКИЙ ГОСУДАРСТВЕННЫЙ МЕДИЦИНСКИЙ УНИВЕРСИТЕТ
КАФЕДРА МИКРОБИОЛОГИИ, ВИРУСОЛОГИИ, ИММУНОЛОГИИ

Д. А. ЧЕРНОШЕЙ, В. В. СЛИЗЕНЬ, Т. А. КАНАШКОВА

ИММУНОЛОГИЯ

IMMUNOLOGY

Лабораторный практикум

9-е издание



Минск БГМУ 2022

УДК 612.017.1(076.5)(075.8)-054.6

ББК 28.074я73

Ч-49

Рекомендовано Научно-методическим советом университета в качестве
лабораторного практикума 17.11.2021 г., протокол № 9

Р е ц е н з е н т ы: канд. мед. наук, доц. В. Э. Бутвиловский; д-р
мед. наук, проф. Г. Н. Чистенко

Черношей, Д. А.

Ч-49 Иммунология = Immunology : лабораторный практикум /
Д. А. Черношей, В. В. Слипень, Т. А. Канашкова. – 9-е изд. –
Минск : БГМУ, 2022. – 64 с.

ISBN 978-985-21-0956-7.

Содержит информацию для подготовки к практическим занятиям по разделу
«Иммунология». Приведены схемы, алгоритмы, справочные сведения, методики
выполнения лабораторных работ. Первое издание вышло в 2013 году.

Предназначен для студентов 2-го курса медицинского факультета иностранных
учащихся (специальность «Лечебное дело»), обучающихся на английском языке.

УДК 612.017.1(076.5)(075.8)-054.6

ББК 28.074я73

ISBN 978-985-21-0956-7

© Черношей Д. А., Слипень В. В., Канашкова Т. А., 2022
© УО «Белорусский государственный медицинский
университет», 2022

Practical class № 1 (9).

Date _____

The topic: Immune system. Innate immunity. Methods for innate immunity factors evaluation

<p>Suggested reading for self-study: Human immune system: organs, cells, molecules (CD; receptors; MHC I, II, III; cytokines, adhesion molecules etc.). Immunity, types of immunity. Innate immunity. Immune and not-immune factors. Complement system: composition, way of activation, functions. Lysozyme, b-lysins. Polynuclear and mononuclear phagocytes systems. Phagocytosis: phases, intracellular killing mechanisms, outcomes. Dendritic cells. Natural killer cells. Methods for estimation of complement system activity and phagocytosis.</p>	<p>[1]: p.15-60; 97-102.</p>
--	------------------------------

Laboratory exercises	Laboratory report
----------------------	-------------------

1. Determine phagocytosis parameters in prepared slides stained by Gimza method.
 Staphylococci are mixed with leucocytes (50:1) and incubated at 37 C for 15-120 min. Then slides are prepared and stained by Gimza method. Under oil immersion the phagocytosing leucocytes and phagocytosed staphylococci are counted and phagocytosis parameters calculated.

$$PI = \frac{\text{Number of phagocytosing leucocytes}}{\text{All leucocytes counted}} \times 100\% \quad N = 40 - 60\%$$

$$PN = \frac{\text{Number of phagocytosed staphylococci}}{\text{Number of phagocytosing leucocytes}} \quad N = 4 - 7$$

2. Register the complement system activity by 50% hemolysis method.
 Serum is diluted and added in wells from 0,05 to 0,5 ml. Then saline solution is added to the final volume of 1,5 ml 1,5 ml of hemolytic system is added to each well. Reaction is incubated at 37 C for 45 min, cooled at 4 C and centrifuged at 1500 rpm for 5 min. The well in which 50% hemolysis occurred is determined visually. This means the volume of patient serum which contains 1 unit of CH50. Next the CH50 for the whole serum is calculated.

Volume of diluted (1:10) serum, ml
 0,05 0,10 0,15 0,20 0,25 0,30 0,35 0,40 0,45 0,50 Standard (50% hemolysis)

1 CH₅₀ – in _____ ml serum
 X CH₅₀ – in 1 ml serum

N 40 – 60 CH₅₀

Demonstration:
 1. Incomplete phagocytosis of *N. gonorrhoeae*
 2. Incomplete phagocytosis of *K. rhinoscleromatis*

Smear _____
 Stain _____

Smear _____
 Stain _____

Signature of the tutor _____

Additional and self-testing materials

Markers of cells-effectors of innate immunity system (monocytes/macrophages):					
Phagocytes markers			Methods for phagocytosis evaluation		
Marker	monocyte/macrophage	granulocyte	Function	Stage	Method
Scavenger receptor (CD163 a, b)	+	-	Recognize and bind polyanionic ligands (LPS, LTA); is involved in phagocytosis	Chemotaxis	Leucocytes chemotaxis under agarose
FcR1 (CD64)	+	-		Adhesion	
CD115	+	-		Engulfment	Direct methods: phagocytosis of staphylococci, candida (calculation of phagocytic index and figure). Indirect methods: phagocytosis of dies, latex or ferrum particles, etc.
CD163	+	-		Killing	Direct methods: phagocytes bactericidal index. Indirect methods: MTT (NBT) test, myeloperoxidase activity determination etc.
CD66, CD92	-	+		Ag presentation	
Receptors of phagocytes					
Receptors, involved in phagocytosis					
Scavenger (CD163 a, b), MCP		Phagocytosis objects recognition			
Receptors to complement components 1, 2, 3		Opsonization, phagocytosis increase, phagocytes activation			
Fc receptors 1, 2, 3 (CD64, CD32, CD16)		Opsonization, phagocytosis increase, phagocytes activation , antibody dependent cellular cytotoxicity			
Receptors for an immune response generation (recognition of «danger and/or damage» signals)					
CD14, TLRs, MCP		Recognition of pathogen type, cell activation, certain profile cytokines production			
Receptors involved in chemotaxis and migration					
Chemokines receptors		Chemotaxis			
L-selectin (CD62)		Rolling, halt, transmigration			
LFA I, III (CD11a/CD18, CD58)					
ICAM I, II (CD54, CD102), CD31					
Receptors involved in antigen presentation and costimulation					
MHC I		Presentation of antigens in cytoplasmic pathway (intracellular antigens) to CD8+ T-lymphocytes			
MHC II		Presentation of antigens in endosome pathway (extracellular antigens) to CD4+ T-lymphocytes			
CD80/86, CD40		T-cells costimulation			
Cytokines receptors (very selected)					
IFN gamma		Strong phagocyte activation, cytolytic and bactericidal capacity increase			
IL10		Phagocytes suppression			
Natural killers (NK)					
NK markers					
Marker	Function				
CD56	Adhesion molecule				
CD57	Adhesion molecule				
CD16	IgG FcR of the 3 rd type				

NK receptors involved in killing		NK subpopulations		
Selected receptors activating killing KAR(KAP)		Marker/function	Active NK	Quiescent NK
CD161	C-type lectin, recognizes carbohydrates of cellular surface.	CD56	±	+++
CD16	IgG FcR of the 3 rd type, involved in antibody dependent cellular cytotoxicity	CD57	+	+
Selected receptors, inhibiting killing (KIR)		CD16	±	++
CD94, gp49B	Killing inhibition	CD69	++	-
p70	Recognition of classic MHC A, B antigens, killing inhibition	Intercellular interactions molecules	++	-
CD158a, b	Recognition of classic MHC C antigens, killing inhibition	K-562 lysis	++	±
Adhesion molecules necessary for intercellular interactions		ADCC	±	++
Receptors involved in chemotaxis and migration		Proliferation to IL2	++	±
Chemokines receptors	Chemotaxis	Circulation	Liver, uterus mucosa, tissues	Blood, spleen
L-selectin (CD62)	Rolling, halt, transmigration			
LFA I, III (CD11a/CD18, CD58)				
ICAM I, II (CD54, CD102), CD31				
Selected cytokines receptors				
Receptors to IL2, 4, 10, 12, 15, IFN gamma	Killing activation, cytokines production			

Complement system

Activation pathway	Classic	Alternative	Lectin
Activators			
C3-convertase composition			
C5-convertase composition			
Scheme of MAC development			

Regulation of the complement system activity

A. Blood enzymes: eliminate and inactivate complement components

- Factor I eliminate C3b both in solution and on the cell surface
 - Cleaved C3b can not function in C3 convertase
 - Factor I produces bioactive C3c and C3e fragments
 - Factor I can also cleave C4b, but only in the presence of C4b-binding protein (C4BP)
- Anaphylatoxins inactivator (serum carboxypeptidase N) – cleaves C3a, C5a, C4a

B. Non enzyme plasma proteins: bind and inhibit complement components

- C1 inhibitor - (plasma alpha-globulin) -
 - Dissociates C1qrs to subunits. Also inhibits plasmin, Hageman’s factor etc. C1inh deficiency lids to inherited angioneurotic edema
- Factor H – works together with factor I: binds and catalyses C3b inactivation.
- C4bBP – controls membrane-bound C4b. Like factor H and C3b, C4bBP binds C4b and makes it accessible for factor I.
- S-protein (vitronectin) – protects target cells from lysis by binding C5b67 complex and giving it wrong orientation. This makes MAC formation impossible.

B. Regulatory proteins of cellular membrane

- Decoy accelerating factor (DAF) and membrane co-factor protein (MCP) perform same function as factor H and C4bBP, but bind C3b and C4b on the cell surface.
 - DAF control C3 convertase function by dissociation of C4b+C2a and C3b+Bb. DAF deficiency lids to paroxysmal night hemoglobinuria
 - MCP – integral membrane protein that makes C3b and C4b accessible for cleavage by factor I.
- Homologues restricting factor (HRF) or C8-binding protein: declines C8 binding C5b67 complex.

Acute phase proteins

Acute phase proteins are referred as humoral factors of an innate immunity and permanently present in blood. But in systemic inflammation condition under proinflammatory cytokines influence (IL1, TNF alpha, IL6) their production by reticular-endothelial cells and hepatocytes increases dramatically. They include: fibrinogen, C-reactive protein (CRP), plasma amyloid protein, mannose binding protein, alpha-1-antitrypsin etc. Acute phase proteins determination (CRP) is used in clinic for the inflammation intensity evaluation.

Protein	Characteristics	Function
CRP Plasma amyloid protein	Belong to pentraxin family (are composed of 5 subunits); M CRP = 23000X5=110000-115000. Normal concentration ~ 1 mg/L; in systemic inflammation – up to 2 g/L. By chemical structure they are C-type lectins and can bind microbial carbohydrates, phosphorylcholine, DNA, extracellular matrix, etc.	After binding pentraxin can activate complement by classic and alternative pathways. Bond CRP is a chemoattractant for neutrophils and can stimulate phagocytosis.
Mannose-binding protein	Belong to collectin family. Normal blood concentration is 0,1-1 mg/L; in systemic inflammation – 10 times as much. It is composed of 18 chains. Each chain includes collagen-like and C-lectin fragments and can bind terminal sugars of microbial surface.	After binding it turns to serine protease and can activate complement by lectin pathway. Activated MBP can also cleave C2 and C4 (activation complement by classic pathway).

Class 1. Immune system. Innate immunity. Methods for innate immunity factors evaluation.

Antigens and receptors of an immune system

CD (antigens) classification

CD antigens = a structure or molecule of the cell membrane that is employed to differentiate human leukocyte subpopulations based upon their interactions with monoclonal antibodies. The monoclonal antibodies that interact with the same membrane molecule are grouped into a common cluster of differentiation (CD). The CD designation was subsequently used to describe the recognized molecule or antigen. CD nomenclature is used by most investigators to designate leukocyte surface molecules. Every CD studied received a number, for example CD4, which stands only for the order of discovery. In general, each CD is associated with one or more functions, which were discovered through the effects on cell or tissue function of the antibodies that defined it.

Receptors of an immune system:

- **antigen recognition receptors (TCR, BCR, CD1)**
- **chemokine receptors**

Cell surface molecules that transduce signals stimulating leukocyte migration following the binding of the homologous chemokine. These receptors belong to the seven transmembrane and alpha-helical, G protein-linked family. Certain CR pattern is characteristic for separate immune cells subpopulation or is obligatory for some immune process: for example CCR1, CCR5 and CXCR3 on Th1 cells attract them to sites of tissue inflammation; CCR4, CCR3 and CCR8 direct Th2 cells to mucosae; CR7 on naive lymphocytes guides them to lymph nodes. Complex system of chemokines and CR expression controls cells migration through the lymphoid or inflammatory tissues and ensures their function. CRs are important target for viruses: CCR3 and CHCR5 are used by HIV to infect T-lymphocytes and other cells of an immune system.

Cytokine receptors include

- the hematopoietic cytokine receptor superfamily. These receptors (Type I) share a tryptophan–serine–X–tryptophan–serine sequence on the proximal extracellular domains and recognize cytokines with a structure of four alpha-helical strands, including IL2 and granulocyte colony-stimulating factor (G-CSF).
- the receptors for type I and type II interferon (Type II).
- the nerve growth factor receptor superfamily (Type III). These receptors recognize tumor necrosis factor (TNF), CD40, nerve growth factor, and Fas protein.
- the immunoglobulin receptor superfamily (Type IV): they recognize IL1 receptors, some growth factors and colony-stimulating factors which have Ig domains,
- the G protein coupled receptor superfamily (Type V).
- the receptor tyrosine or serine kinases plus an unclassified group.

Cytokine receptors are specialized cell surface structures where cytokines bind, thus leading to new cell activities that include growth, differentiation, and death. Cytokine receptors share some features in common. They have a high affinity for ligand. Typically a hundred to a few thousand receptors are present per cell. Most cytokine receptors are glycosylated, integral, type I membrane proteins. Functional cytokine receptors are usually complex structures requiring the formation of homologous or heterologous associations between receptor chains. A cytokine receptor group may share chains dubbed “public subunits” and ordinarily engage in signal transduction. Unique chains termed “private subunits” usually determine binding specificity.

Apoptosis receptors

The process of apoptosis (programmed cell death) can be induced by number of inner and external factors. In the context of extrinsic apoptotic pathway apoptosis is regulated by signals generated when cytokines bind to death receptors such as *Fas* and TNFR. Cytokines producing inductive signals include TNF- α , FAS ligand (promote apoptosis) and TRAIL1-2 ligand (inhibit apoptosis). Ligation of them leads to the trimerization of receptor. This brings the death domains in the receptor cytoplasmic tails together. A number of adaptor proteins containing death domains bind to the death domains of activated apoptosis receptor, which in turn interacts through a second death domain with the protease caspase 8. Clustered caspase 8 can transactivate, cleaving caspase 8 itself to release an active caspase domain that in turn can activate other caspases. Caspase 8 also cleaves BID to truncated BID (tBID), activating the mitochondrial-regulated apoptotic pathway, dramatically accelerating cellular death.

The ensuing caspase cascade culminates in the activation of the caspase-activatable DNase (CAD), which is present in all cells in an inactive cytoplasmic form bound to an inhibitory protein called I-CAD. When I-CAD is broken down by caspases, CAD can enter the nucleus where it cleaves DNA into the 200-base-pair fragments that are characteristic of apoptosis.

Proliferating cells often undergo apoptosis as a natural process of growth regulation and proliferating lymphocytes manifest rapid apoptosis during development and during immune responses.

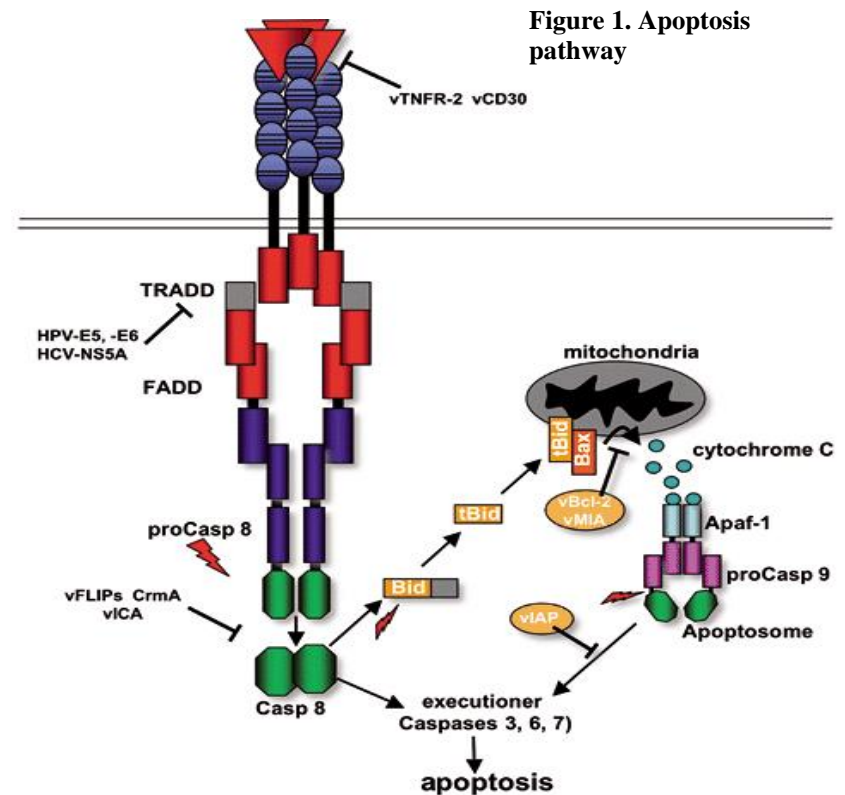

Immunoglobulins receptor

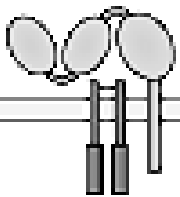
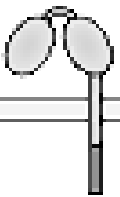
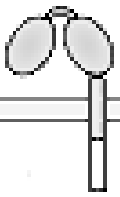
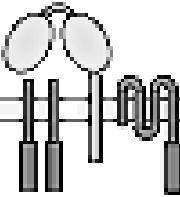
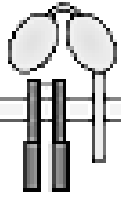
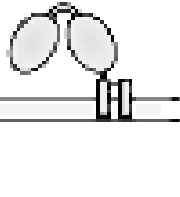
Fc γ RI (CD64)	Fc γ RII (CD32)	Fc γ RIIIA(CD16)	Fc γ RIIIB (CD16)	Fc ϵ RI (CD64)	Fc $\alpha\gamma$ RI (CD89)			
								
γ_2 α	α	α	γ_2 α β	α -GPI	γ_2 α β	γ_2 α	γ_2 α	
High	Average		Low		High		High	
Macrophages, neutrophils, eosinophils, dendritic cells	Macrophages, neutrophils, mast cells, eosinophils, platelets, dendritic cells,	Macrophages, neutrophils, eosinophils, mast cells, dendritic cells, FDC, B cells	Mast cells, basophils	Macrophages, mast cells, basophils, NKs, dendritic cells,	Neutrophils	Mast cells, basophils	Macrophages, neutrophils, eosinophils, dendritic cells,	Macrophages, neutrophils, eosinophils
Activation Inducible by inflammatory cytokines; enhance effector response; IC capture by DCs	Activation Effector cell activation by ICs, cytotoxic Ab	Inhibition Set threshold for effector activation by Fc; B-cells suppression; maintain tolerance	Activation Dominant pathway for effector cells activation by IgG; ADCC; Arthus reaction; ICs capture by DCs	Decoy Sink for IC; focus ICs to PMN;	Activation Degranulation; Allergic reaction (Type I)	Activation Degranulation; Allergic reaction (Type I); antigen capture by DCs	Activation IgA activation of effector cells	

Complement Receptors

<i>Type</i>	<i>Ligand</i>	<i>Structure, MW</i>	<i>Distribution</i>	<i>Function</i>
CR1 (CD35)	C3b > C4b > iC3b	Single-chain glycoprotein, 160-250 kDa; allotypes A through D with 30, 37, 23, or 44 SCRs	Monocytes, macrophages, neutrophils, eosinophils, erythrocytes, B and T cells, FDC, mesangium cells in glomeruli	Immune complex clearance, immune complex localization to germinal centers, regulator of C3 and C5 activation
CR2 (CD21)	C3dg/C3d, iC3b, EBV, CD23, IFN- α	Single-chain glycoprotein, 140-145 kDa; two isoforms: CD21S or CD21L (15 or 16 SCRs)	B cells, activated T cells, epithelial cells, FDC (CD21L)	B cell activation, immune complex localization to germinal centers, rescue of germinal center cells from apoptosis
CR3 (CD11b/CD18)	iC3b, ICAM-1, LPS, fibrinogen, factor X, carbohydrates	Heterodimeric glycoprotein, O \pm + OI chain: 165 + 95 kDa	Monocytes, macrophages, neutrophils, NK cells, FDC, T cells, mast cells	Phagocytosis, cell adhesion, signal transduction, oxidative burst
CR4 (CD11c/CD18)	iC3b, fibrinogen	Heterodimeric glycoprotein, O \pm + OI chain: 165 + 95 kDa	Monocytes, macrophages, neutrophils, NK, T cells, mast cells	Phagocytosis, cell adhesion
CR1g	C3b, iC3b	IgG superfamily	Tissue-resident and sinusoid macrophage	Phagocytosis of circulating pathogens
C3aR	C3a	Single chain of 48 kDa, G-protein-linked receptor	Mast cells, basophils, smooth muscle cells, lymphocytes	Increases vascular permeability, triggers serosal type mast cells
C5aR (CD88)	C5a, C5a ^{desArg}	Single chain of 43 kDa, G-protein-linked receptor	Mast cells, basophils, neutrophils, monocytes, macrophages, endothelial cells, smooth muscle cells, lymphocytes	Increases vascular permeability, triggers serosal type mast cells, promotes chemotaxis
C5L2	C5a, C5a _{desArg} , C3a, C3a _{desArg}	Single chain of 37 kDa, G-protein-linked receptor	Neutrophils, immature DCs, preadipocytes, adipocytes	Stimulates triglyceride synthesis Limits pro-inflammatory response
C1qR_p	C1q (collagenous part), MBL, SP-A	Single chain of 126 kDa, highly glycosylated	Monocytes, macrophages, neutrophils, endothelial cells, microglia	Phagocytosis
cC1qR (collectin-receptor)	C1q (collagenous part), MBL, SP-A, CL-43	Single chain of 60 kDa, acidic glycoprotein	B cells, monocytes, macrophages, platelets, endothelial cells, fibroblasts	Phagocytosis, localization of immune complexes; enhances ADCC, oxidative metabolism
gC1qR	C1q (globular heads)	Tetramer of 33-kDa subunits, acidic protein	B cells, monocytes, macrophages, platelets, endothelial cells, neutrophils	Inhibits complement activation, phagocytosis

MHC genes and antigens

Human Leucocyte Antigens (HLA) are glycoproteins encoded by genes of Major Histocompatibility Complex (MHC).

In immune system the glycoproteins perform a very important function: they determine biologic individuality of each human being and take part in peptide antigen presentation to T-lymphocytes by antigen-presenting cells (APC).

HLA-molecules encoded by MHC-genes are subdivided into glycoprotein of **class I** MHC (HLA-A, HLA-B, and HLA-C; these glycoproteins presented on the surface of all somatic cells excluding the extravillous trophoblast cells and erythrocytes) and **class II** MHC (HLA-DP, HLA-DQ, and HLA-DR; they are predominantly expressed on membranes of the APC).

The MHC complex includes 2000 allelic genes. The map of the human MHC is shown in Fig. 2.

MHC-I. includes loci HLA-A, HLA-B and HLA-C and encodes class I MHC molecules.

MHC-II. Includes loci HLA-DP, HLA-DQ and HLA-DR and encodes class II MHC molecules.

MHC-III. The term "MHC-III" designates the region MHC-I and MHC-II genes. It includes genes of complement components (C4a and C4b, C2, factor B), cytokines (TNF-a and lymphotoxin) etc.

Also several unclassical genes similar in structure and involved in presentation and immune cells interaction were located in MHC. There are 6 MHC-I-like genes (E, F, G, H, J, X) and 6 MHC-II-like (DM, DO, CLIP, TAP, LMP, and LNA).

Map of the MHC

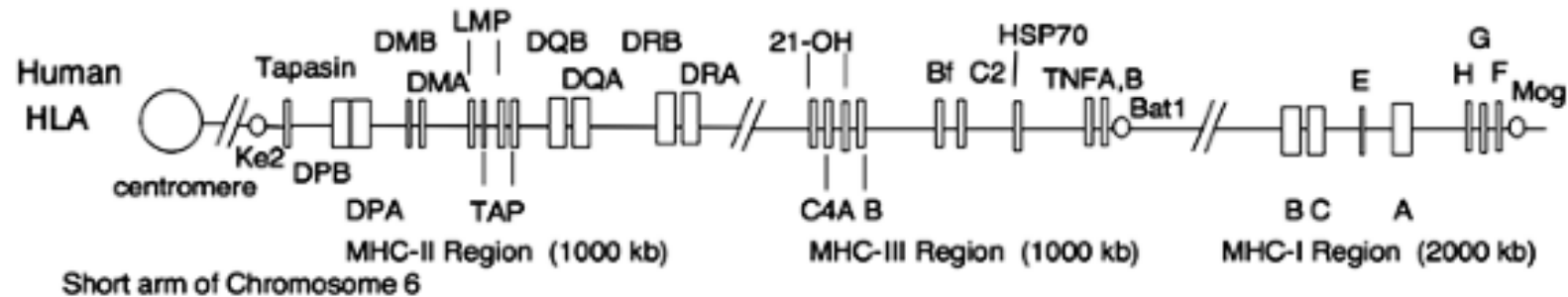
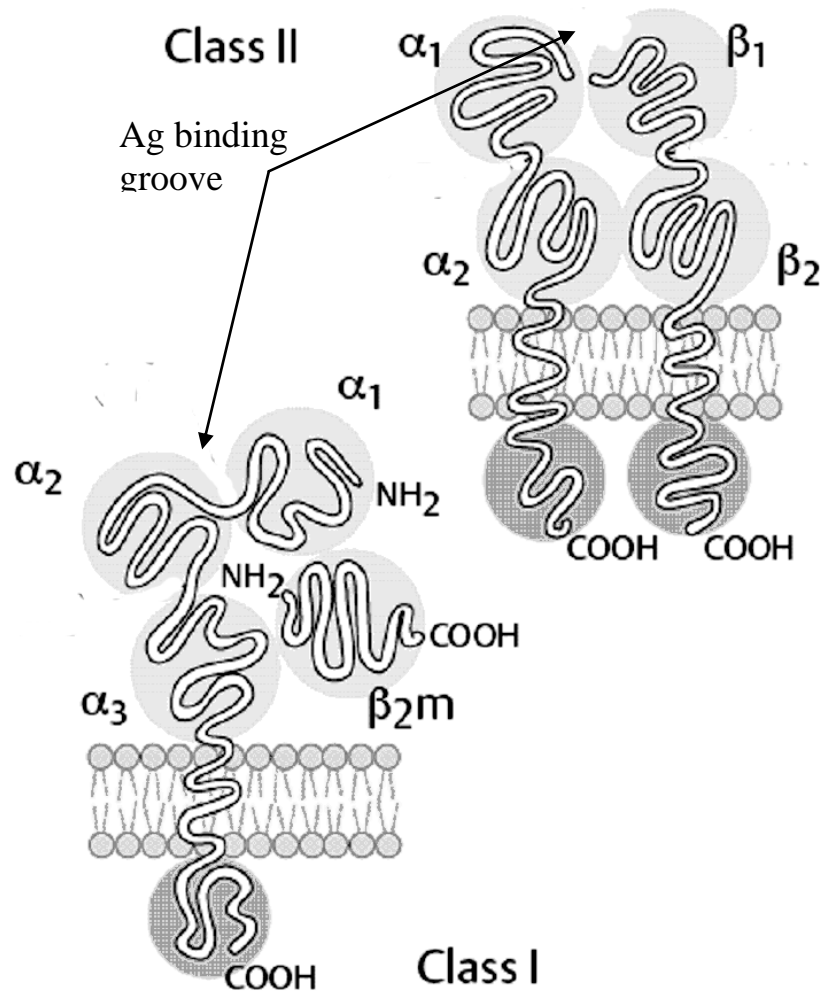

Figure 2. MHC map



MHC-I molecule (Fig. 3) contains long transmembrane a-chain and short extracellular b-2-microglobulin. a-chain contains 3 extracellular domains (α_1 , α_2 , and α_3), transmembrane region and cytoplasmic region of 55 aa. α_1 and α_2 domains form a "groove" to bind Ag peptides of 9-11 amino acid.

MHC-II molecules (Fig. 3) are heterodimers of two transmembrane glycoproteins: a-chain and b-chain. Extracellular portion of each chain consists of two domains, α_1 - and β_1 domains jointly form a peptide-binding groove which can bind peptides up to 30 aa.

MHC genes are codominant, i.e. expressed from both maternal and paternal alleles. Thus, usually person has 6 active alleles of MHC-I and same of MHC-II genes. Because of limited capabilities to bind different peptides the great diversity of MHC alleles make it more difficult for microbes to escape immune response. The "side effect" of this advantage is transplantation immunity: immune cells learn to recognize antigens in context of MHC molecules and can easily response to different (compare with self) MHC structures expressed on donor's tissues.

Figure 3. MHC classical molecules structure

Dendritic cells

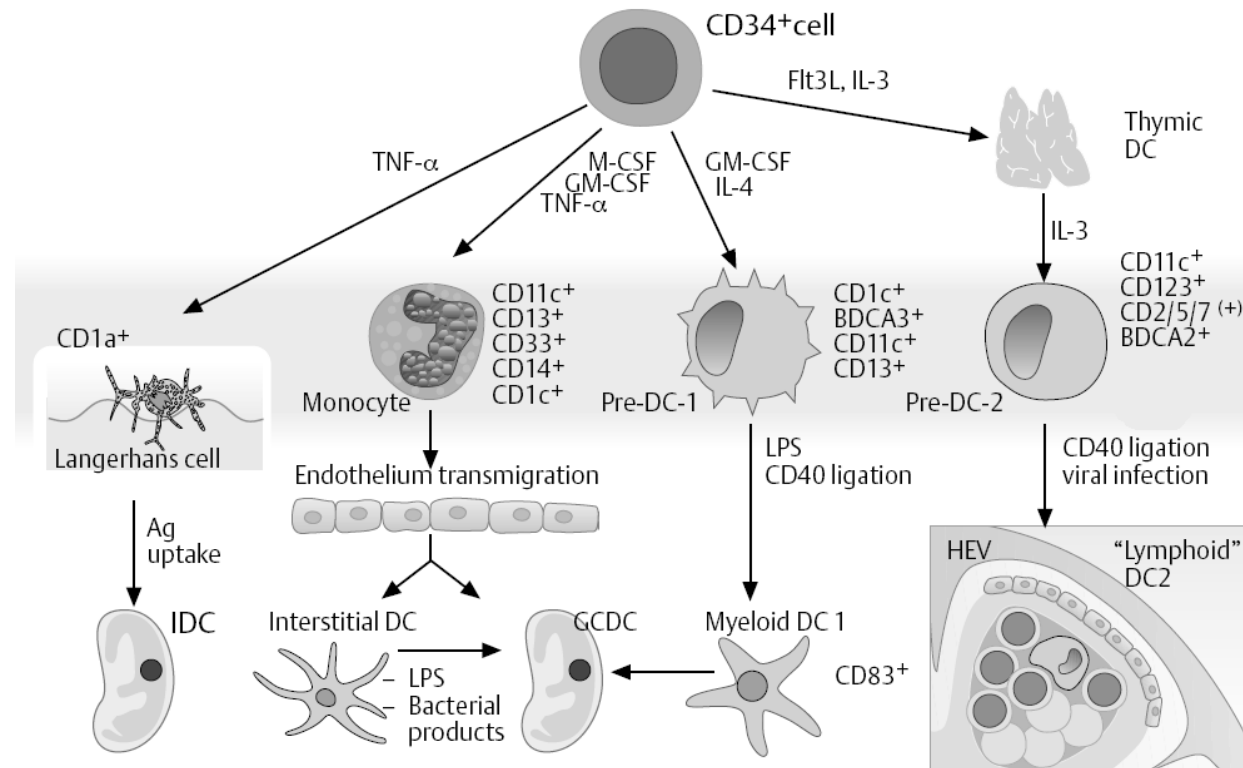

Dendritic cells (DCs) belong to the myeloid lineage. They differentiate from hematopoietic stem cells in response to TNF α , IL4 and GM-CSF. DCs are found in all tissues. One of the best studied is Langerhans cells (LCs) in the skin.

Mature monocytes can differentiate into interstitial DCs in organs. Mature DCs are rarely found in blood, but a small percentage of blood mononuclear cells has morphological features of immature DCs (small cytoplasmic protrusions, MHC and costimulatory molecules expression and CD83). These cells, pre-DC-1, express myeloid antigens (CD13, CD11c, CD1c and BDCA3). They can be induced into typical DCs in vitro in response to IL4, GM-CSF and TNF α . In mature condition they produce large amounts of IL12 (Type 1 DC). Some rare blood mononuclear cells respond to IL3 and Flt3L, giving a cell population which lacks the myeloid CD13 and CD33, while expressing T-cell associated antigens (CD2, CD5, CD7), BDCA2 and 4 and TLR9. These cells are found in paracortical region of lymph nodes and given to their morphology are named “plasmacytoid” DC. In response to IL3 and CD40 they acquire typical dendritic morphology and produce high levels of IFN α and IL10 (Type 2 DC).

LCs capture antigens at the sight of inflammation and processed them while migrate into efferent lymph tract (veiled cells). LCs transport antigen to the regional lymph nodes. Here they prime and activate CD4+ T-cells, providing them all necessary costimulation (CD40, CD80/86 and cytokines).

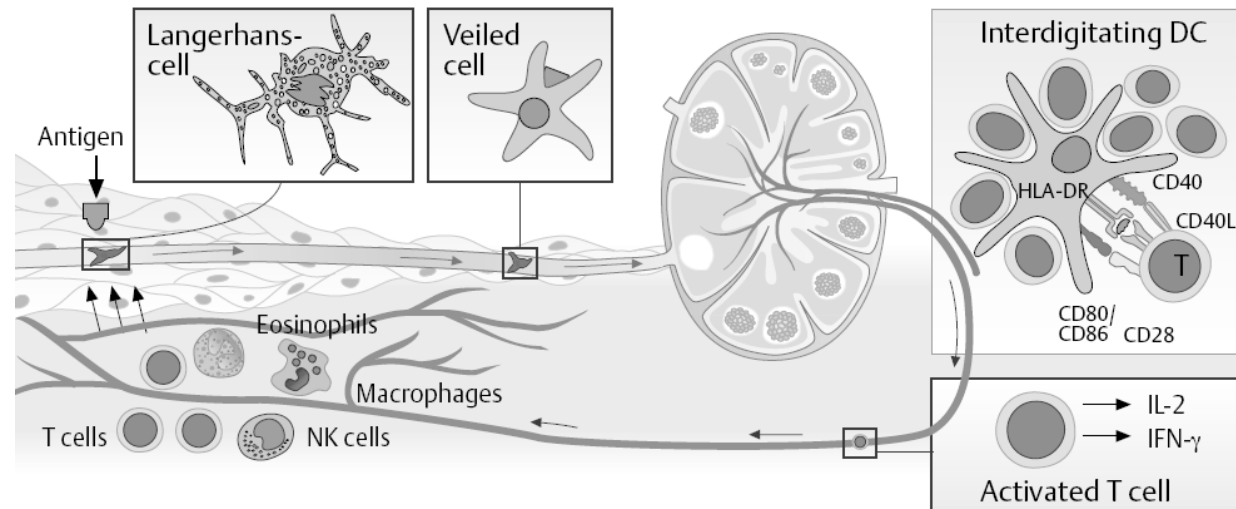

Molecules of an immune system

Complement system.

Complement system includes more than 35 plasma or membrane proteins and serves as an auxiliary system in immunity and antimicrobial defense. It is activated through a cascade of proteolytic steps, performed by serine protease domains in some of the components. Three different pathways of activation are distinguished, triggered by either target-bound antibody or immune complex (the classical pathway), by microbial repetitive polysaccharide structures (the lectin pathway), or by recognition of other foreign surface structures (the alternative pathway). The alternative pathway also amplifies C3 activation triggered by the other pathways. All three merge in the pivotal activation of C3 and, subsequently, of C5 by highly specific enzymatic complexes, so-called convertases. In the common terminal pathway, downstream of C5 further complement components are activated in a nonproteolytic manner and assembled into the membrane attack complex (MAC). The entire powerful activation machinery is controlled redundantly by >10 negative regulators.

Complement can be activated by a variety of stimuli, such as immune complexes, appearance of apoptotic cells, presence of non-self-tissue (e.g., after transplantation) and microbial surface patterns directly. The broad spectrum of effector functions includes clearance of immune complexes

or apoptotic cells, enhancement of inflammation (e.g., by the anaphylatoxins C3a and C5a), and cooperation with other host defense mechanisms as well as direct antimicrobial attack with subsequent opsonization and/or lysis.

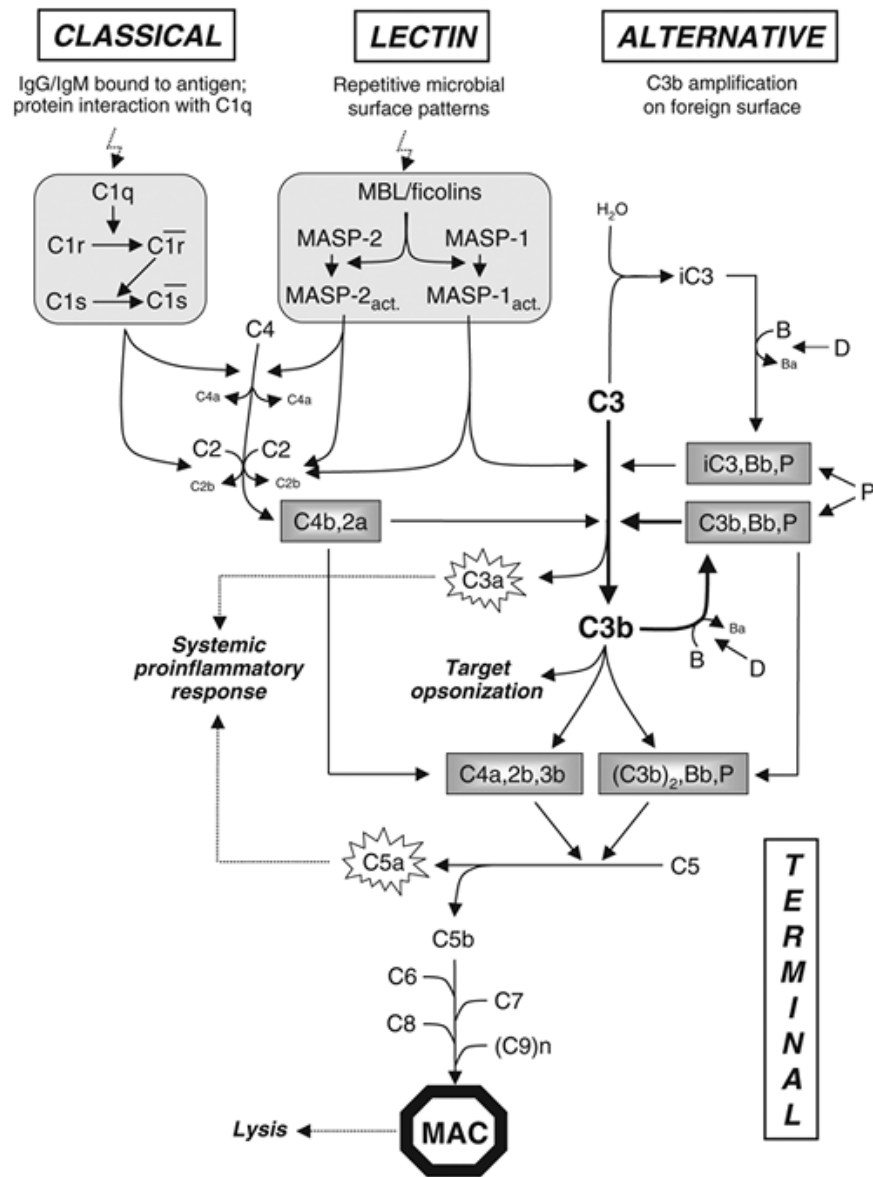

Complement factors are mainly produced in the liver by monocytes/macrophages and other cells (epithelial and endothelial cells, lymphocytes, dendritic cells, astrocytes and so on). Extrahepatic complement production is also important.

The production of plasma complement components is augmented in the acute-phase response.

Adhesion molecules mediate cell adhesion to their surroundings and to neighboring cells. Adhesion molecules are critical to most aspects of leukocyte function, including recirculation through lymphoid organs, recruitment into inflammatory sites, antigen-specific recognition, and wound healing. The five principal structural families of adhesion molecules are (1) integrins, (2) immunoglobulin superfamily (IgSF) proteins, (3) selectins, (4) mucins, and (5) cadherins.

Integrins belong to a family of cell membrane glycoproteins that are heterodimers comprised of alpha and betachain subunits and serve as extracellular matrix glycoprotein receptors. They bind fibronectin, C3, lymphocyte-function-associated antigen 1 (LFA-1) and other proteins. Differences in the betachain serve as the basis for division of integrins into three categories. The same 95-kDa beta chain is found in one category of integrins that includes LFA-1, p150, p95,

and complement receptor 3 (CR3). The same 130-kDa betachain is shared among VLA-1, VLA-2, VLA-3, VLA-4, VLA-5, VLA-6, and integrins found in chickens. A 110-kDa beta chain is shared in common by another category that includes the vitronectin receptor and platelet glycoprotein IIb/IIIa. The principal function of integrins is to link the cytoskeleton to extracellular ligands. They also participate in wound healing, cell migration, killing of target cells, and phagocytosis. Leukocyte adhesion deficiency syndrome occurs when the betasubunit of LFA-1 and Mac-1 are missing. VLA proteins facilitate binding of cells to collagen (VLA-1, -2, and -3), laminin (VLA-1, -2, and -6), and fibronectin (VLA-3, -4, and -5).

Mucins are heavily glycosated serine- and threonine-rich proteins that serve as ligands for selectins.

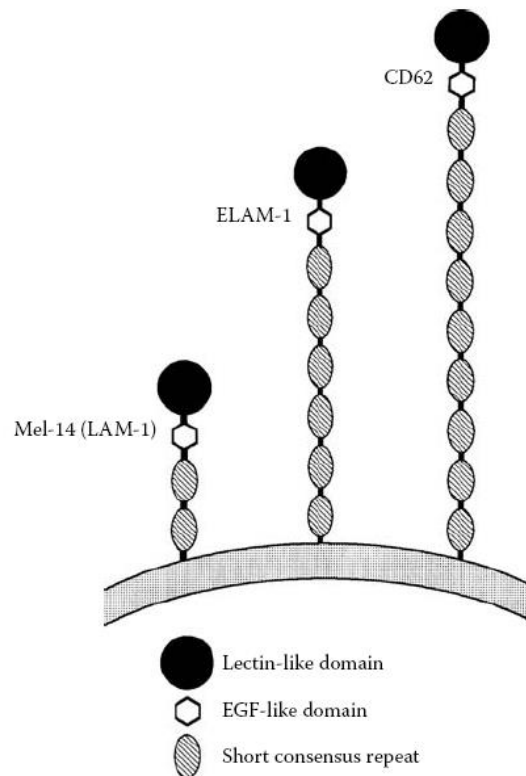

Selectins comprise a group of cell adhesion molecules (CAMs) that are glycoproteins and play an important role in the relationship of circulating cells to the endothelium. Selectins are involved in lymphocyte migration. Three groups of selectins include L-selectin (CD62L) expressed on leukocytes; P-selectin (CD62P) expressed on platelets and activated endothelium; and E-selectin (CD62E) expressed on activated endothelium. The characteristic structural motif is comprised of an N terminal lectin domain, a domain with homology to epidermal growth factor (EGF), and various complement regulatory protein repeat sequences.

Cadherins

One of four specific families of cell adhesion molecules that enable cells to interact with their environment. Cadherins help cells communicate with other cells in immune surveillance, extravasation, trafficking, tumor metastasis, wound healing, and tissue localization. Cadherins are calcium dependent. The five different cadherins include N-cadherin, P-cadherin, T-cadherin, V-cadherin, and E-cadherin. Cytoplasmic domains of cadherins may interact with proteins of the cytoskeleton.

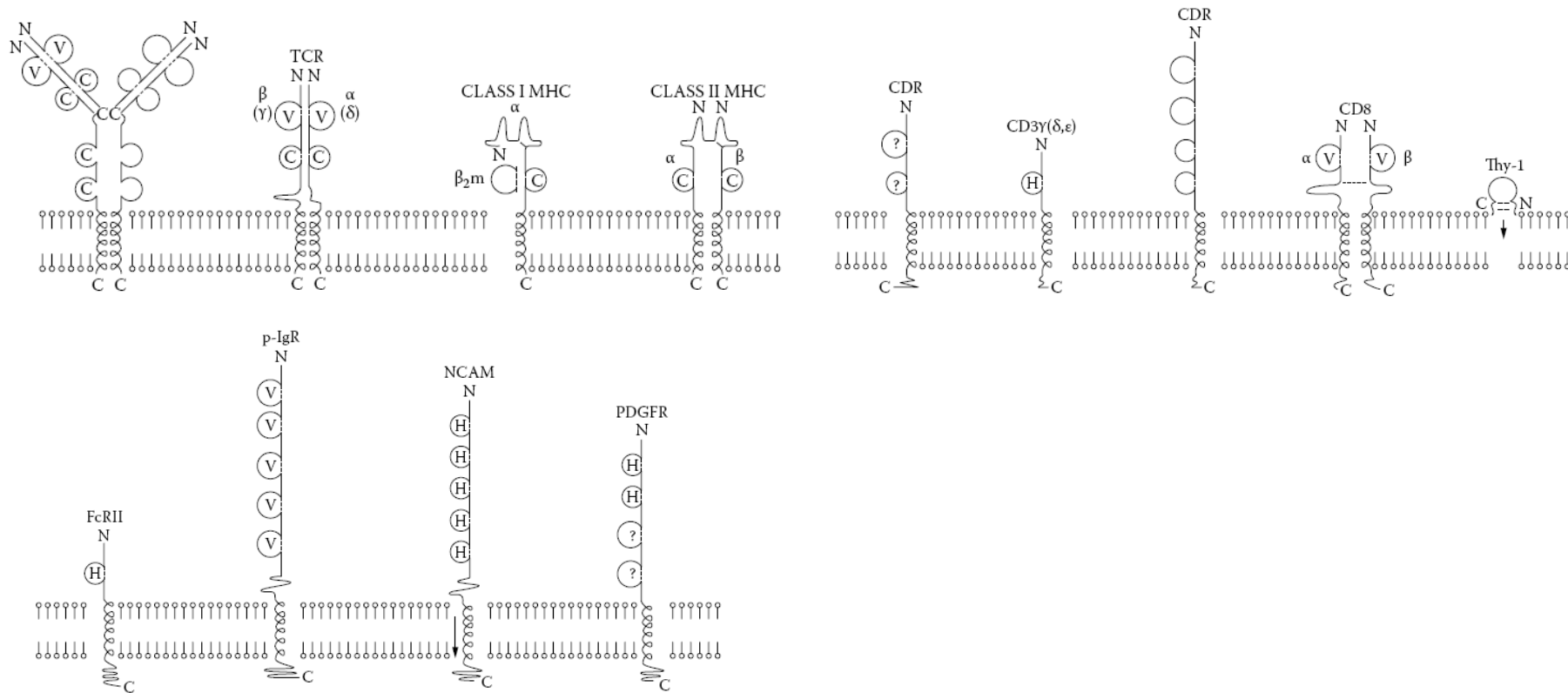

Immunoglobulin superfamily

Several molecules that participate in the immune response and show similarities in structure, causing them to be named the immunoglobulin supergene family. Included are CD2, CD3, CD4, CD7, CD8, CD28, T cell receptor (TCR), major histocompatibility complex (MHC) class I and class II molecules, leukocyte function-associated antigen 3 (LFA-3), the IgG receptor, and a dozen other proteins. These molecules share in common an immunoglobulin-like domain with a length of approximately 100 amino acid residues and a central disulfide bond that anchors and stabilizes antiparallel β -strands into a folded structure resembling immunoglobulin. Immunoglobulin superfamily members may share homology with constant or variable immunoglobulin domain regions. Various molecules of the cell surface with polypeptide chains whose folded structures are involved in cell-to-cell interactions belong in this category. Single-gene and multigene members are included. Protein molecules sharing 15% amino acid homology with immunoglobulin proteins and possessing one or more immunoglobulin domains belong to this large molecular family.

A good example of adhesion molecules function is leucocytes migration from blood to tissues:

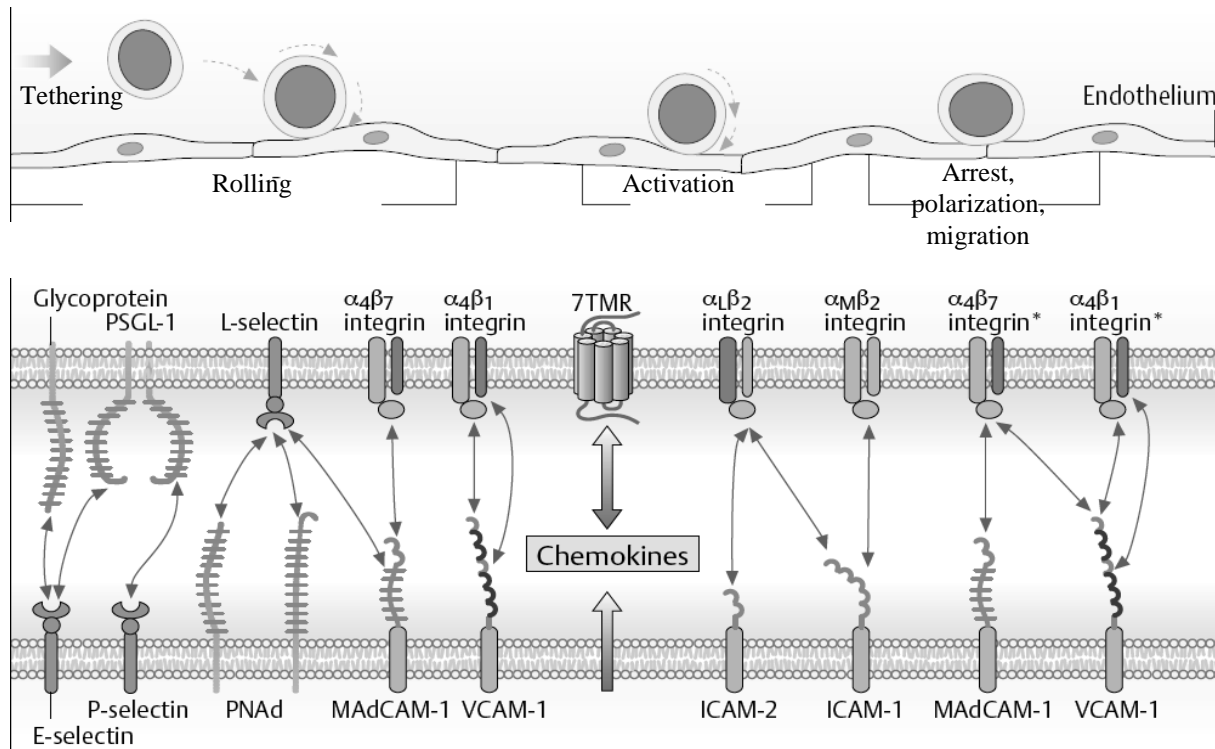

The four stages include: (1) rolling or initial margination by the selectins (L-, P-, E-); (2) stopping on the endothelium by CD18 integrins and ICAM-1; (3) neutrophil–neutrophil adhesion by CD11b/CD18; and (4) transendothelial migration by CD11b/CD18, CD11a/CD18, and ICAM-1.

Cytokines

Cytokines are polypeptides produced in response to microbes and other antigens that mediate and regulate immune and inflammatory reactions.

- Cytokine secretion is a brief, self-limited event.
- The actions of cytokines are often pleiotropic and redundant
- Cytokines often influence the synthesis and actions of other cytokines.
- Cytokine actions may be local and systemic.
- Cytokines initiate their actions by binding to specific membrane receptors on target cells.

- External signals regulate the expression of cytokine receptors and thus the responsiveness of cells to cytokines.
- The cellular responses to most cytokines consist of changes in gene expression in target cells, resulting in the expression of new functions and sometimes in the proliferation of the target cells.

Cytokines of Innate Immunity

Cytokine	Size	Principal cell source	Principal cell targets and biologic effects
Tumor necrosis factor (TNF)	17 kD; 51-kD homotrimer	Macrophages, T cells	Endothelial cells: activation (inflammation, coagulation) Neutrophils: activation Hypothalamus: fever Liver: synthesis of acute-phase proteins Muscle, fat: catabolism (cachexia) Many cell types: apoptosis
Interleukin-1 (IL-1)	17 kD mature form; 33-kD precursors	Macrophages, endothelial cells, some epithelial cells	Endothelial cells: activation (inflammation, coagulation) Hypothalamus: fever Liver: synthesis of acute-phase proteins
Chemokines	8-12 kD	Macrophages, endothelial cells, T cells, fibroblasts, platelets	Leukocytes: chemotaxis, activation; migration into tissues
Interleukin-12 (IL-12)	Heterodimer of 35-kD + 40-kD subunits	Macrophages, dendritic cells	T cells: T _H 1 differentiation NK cells and T cells: IFN- γ synthesis, increased cytolytic activity
Type I IFNs (IFN- α , IFN- β)	IFN- α : 15-21 kD IFN- β : 20-25 kD	IFN- α : macrophages IFN- β : fibroblasts	All cells: antiviral state, increased class I MHC expression NK cells: activation
Interleukin-10 (IL-10)	Homodimer of 34-40 kD; 18-kD subunits	Macrophages, T cells (mainly T _H 2)	Macrophages, dendritic cells: inhibition of IL-12 production and expression of costimulators and class II MHC molecules
Interleukin-6 (IL-6)	19-26 kD	Macrophages, endothelial cells, T cells	Liver: synthesis of acute-phase proteins B cells: proliferation of antibody-producing cells
Interleukin-15 (IL-15)	13 kD	Macrophages, others	NK cells: proliferation T cells: proliferation (memory CD8 ⁺ cells)
Interleukin-18 (IL-18)	17 kD	Macrophages	NK cells and T cells: IFN- γ synthesis

Cytokines of Adaptive Immunity

Cytokine	Size	Principal cell source	Principal cell targets and biologic effects
Interleukin-2 (IL-2)	14-17 kD	T cells	T cells: proliferation, increased cytokine synthesis; potentiates Fas-mediated apoptosis NK cells: proliferation, activation B cells: proliferation, antibody synthesis (<i>in vitro</i>)
Interleukin-4 (IL-4)	18 kD	CD4 ⁺ T cells (T _H 2), mast cells	B cells: isotype switching to IgE T cells: T _H 2 differentiation, proliferation Macrophages: inhibition of IFN- γ -mediated activation Mast cells: proliferation (<i>in vitro</i>)
Interleukin-5 (IL-5)	45-50 kD; homodimer of 20-kD subunits	CD4 ⁺ T cells (T _H 2)	Eosinophils: activation, increased production B cells: proliferation, IgA production
Interferon- γ (IFN- γ)	50 kD (glycosylated); homodimer of 21-to 24-kD subunits	T cells (T _H 1, CD8 ⁺ T cells), NK cells	Macrophages: activation (increased microbicidal functions) B cells: isotype switching to opsonizing and complement-fixing IgG subclasses T cells: T _H 1 differentiation Various cells: increased expression of class I and class II MHC molecules, increased antigen processing and presentation to T cells
Transforming growth factor- β (TGF- β)	25 kD; homodimer of 12.5-kD subunits	T cells, macrophages, other cell types	T cells: inhibition of proliferation and effector functions B cells: inhibition of proliferation; IgA production Macrophages: inhibition
Lymphotoxin (LT)	21-24 kD; secreted as homotrimer or associated with LT β ₂ on the cell membrane	T cells	Recruitment and activation of neutrophils Lymphoid organogenesis
Interleukin-13 (IL-13)	15 kD	CD4 ⁺ T cells (T _H 2)	B cells: isotype switching to IgE Epithelial cells: increased mucus production Macrophages: inhibition

Methods for innate immune system diagnostics

Quantification of neutrophils Neutrophils are routinely quantified in the five-part white cell differential count obtained from hematology analyzers.

An apparently low neutrophil count should always be confirmed by examining a blood film. Alternatively white blood cells can be quantified by counting cell suspension in special camera under microscope. Exact quantity of blood cells can be calculated after their percentage evaluation in blood film.

Prior to considering neutrophil function testing, a blood film should be performed to assess neutrophil morphology, as neutrophils that appear abnormal rarely function normally. Rare genetic abnormalities of neutrophil granulation as well as myelodysplasia (a premalignant condition in which neutrophil development and function is abnormal) can readily be recognized on a blood film. In these conditions formal neutrophil testing rarely adds to the management of the patient.

Adhesion Measurement of key neutrophil adhesion molecules using standard flow cytometry techniques is commonly used. The adhesion molecules which may be measured in this way include CD15 – sialyl Lewis x, CD11a, CD11b, CD11c and CD18.

Neutrophil adhesion assays involve allowing neutrophils to adhere to plastic, fibronectin coated glass or cultured endothelium. Unbound neutrophils are washed away and the adherent neutrophils quantified either by microscopy or measurement of a neutrophil specific protein such as myeloperoxidase.

Chemotaxis Neutrophil chemotaxis (migration in response to chemotactic stimuli) may be measured under agarose. Wells cut into agarose are filled with neutrophils, chemoattractant or control saline, and the numbers of cells migrating after a defined period are counted. A control is always included and the results are compared with age-matched controls. Alternatively, specialized Boyden chambers may be used.

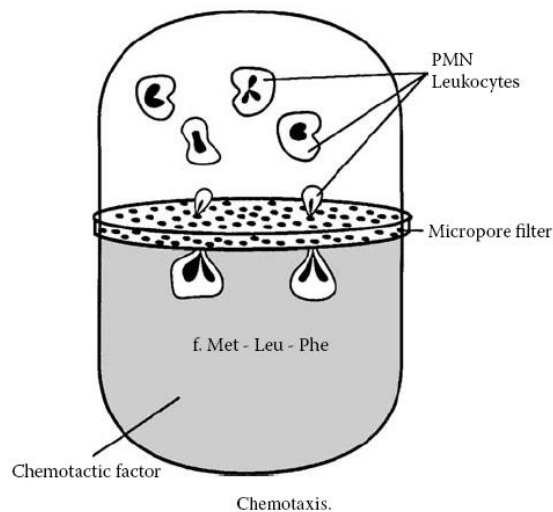

Phagocytosis Phagocytosis of organisms is measured using latex particles or stained organisms incubated with patient cells. The percentage of cells that have ingested particles (phagocytosis index) and the number of particles ingested (phagocytosis number) is compared to controls. If fluorescent particles are used, phagocytosis can be measured by flow cytometry. In both assays distinguishing adherent particles on the cell surface from those that have been phagocytosed is difficult.

Respiratory burst The nitroblue tetrazolium (NBT) test relies on reduction of NBT to formazan by oxygen radicals produced by stimulated neutrophils. Neutrophils are incubated with colorless NBT, appropriately stimulated and the presence of formazan is assessed visually using a microscope or by spectrophotometry. Intracellular dyes, which become fluorescent after reduction by reactive oxygen intermediates, have led to flow cytometric equivalents of the NBT test.

Practical class № 2 (10).

Date _____

The topic: Humoral immune response

Suggested reading for self-study: Immune response, definition, main factors. Antigens: definition, main features, classification. B-lymphocytes system. B cells genesis. B cell receptor (BCR). B-cell activation, proliferation, differentiation to plasmocyte, immunoglobulin production. Humoral immune response. Primary and secondary humoral response.
 Immunoglobulins: structure, functions. Classes and subclasses of immunoglobulins. Monoclonal immunoglobulins.
 Methods of B-lymphocytes evaluation: quantitative and functional tests.

[1]: p.61-75; 97-102.

Laboratory exercises

1. Determine the quantity of B-cells by immune rosettes methods in ready made slides.

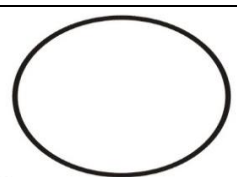

Smear _____
 Stain _____

Laboratory report

The method reveals CD20 antigen on B-cell surface;
 Normal B-cells count by CD20 = 8-20% total blood lymphocytes.

2. Determine an IgG concentration in serum by Manchini method (simple radial gel immunodiffusion).

IgG standard = 20 g/L

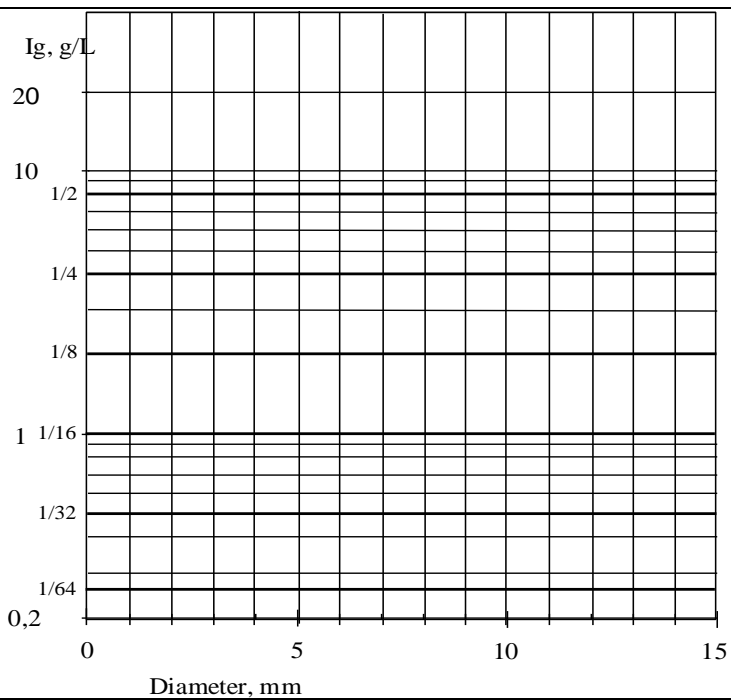

Standard curve

	Titer	Concentration, g/L	Diameter, mm
1 point			
2 point			
3 point			
4 point			
5 point			
Experiment			

Normal IgG ranged 9,5-14,5 g/L

Conclusion: _____

Signature of the tutor _____

1. Receptors and markers of B-lymphocytes

At present more than 40 surface molecules are identified on B cell. The structure, functions, genes etc. are known for the majority of them.

One can divide these molecules between several groups according to function:

A. Molecules involved in antigen recognition and signaling

- a) surface immunoglobulins (always monomeric and have additional membrane anchoring domen. The synthesis of both secreted and membrane form of immunoglobulin is possible due to alternative transcription of heavy chain gene.
- б) CD79a and b (transmit the main signal about antigen recognition by surface immunoglobulin).
- в) CD21 – complement receptor type 2 (for C3d).
- г) CD19 – integral membrane glycoprotein; makes a complex with CD21 and TAPA1 (CD81). Presents on all B cells beginning with pro-B-cells. Absent on plasmacytes.
- д) CD81 (TAPA) – belongs to TM4 family (one chain proteins with four transmembrane domens), BCR coreceptor.
- е) CD45 – membrane associated phosphatase. It dephosphorylates Tir phosphatases, linked to BCR, and thereby it gets the signal system ready and regulates its activity. Different isoforms of CD45 (mainly CD45RA) are available on all B cells.
- ж) CD40 – glycosylated phosphoprotein (belongs to tumor necrosis factor family. Extremely important for B-cells activation, apoptosis abolition and immunoglobulin isotype changing.

B. Molecules for cells interaction and antigen presentation to T-cells

- a) CD40 – CD154 (CD40L) – the most powerful costimulatory signal for B cells.
- б) CD80, CD86 – CD28, CTLA – mutual costimulation for T and B cells (important costimulator for T cells).
- в) CD72 – CD5 – adhesion of T and B cells, proliferation of B cells.
- г) CD54 (ICAM1) - LFA1(CD11a/CD18) adhesion, costimulation.
- д) CD58(LFA3) – CD2 adhesion, costimulation.
- е) MHC type II molecules – CD4 – restriction of an immune response

C. Molecules for distant interaction

- a) IL2 receptor – CD25, CD122, CD132
- б) IL4 receptor – CD124, CD132
- в) IL5 receptor – CD125, CD131
- г) IL6 receptor – CD126, CD130
- д) IFNgamma receptor – CD119
- е) IL1 receptor – CD121.
- ж) TNFa receptor – CD120.

Immunoglobulin isotype regulation by T-cells cytokines

Cytokine	IgG1	IgG2a	IgG2b	IgG3	IgA	IgE	IgM
<i>IL-4</i>							
<i>IL-5</i>					↑ production		
IFN-gamma							
TGF-beta							

Cytokines can stimulate (grey) or inhibit (black) changing to the isotype indicated.

D. Activation markers

- a) CD25 and other inducible cytokine receptors
- б) CD69 – proliferation signal
- в) CD71 – transferring receptor
- г) CD23 – low affinity type II receptor for IgE.
- д) inducible hyperexpression of type II MHC molecules
- е) CD30 – transduction of signal about proliferation/apoptosis

E. Other important molecules

- CD32 – type II Fc-receptor for IgG – transduces negative signal and regulates immunoglobulins production.
- CD5 – associated with BCR, involved in B1 cells activation.
- CD49 – interaction with extracellular matrix.
- CD24 – costimulation and activation of B-cells.
- CD35 – type I complement receptor (for C3b).

2. B lymphocytes subpopulations

Feature	B-1 lymphocytes	B-2 lymphocytes
Genesis	Separate stem cell; leaves BM early in ontogenesis	BM, common stem cell
Area	Body cavities (pleural, abdominal)	BM, peripheral organs of an immune system
Specificity	Common microbial structures (markers of infectious foreign), invariant fragments of immunoglobulins, TCR, MHC, adhesion molecules etc.	Unlimited specificity (up to 10^{16} variants), molecules of any types or origin, evolution of the repertoire is not found
Isotype	Mainly IgM	Any isotype*
Function	Synthesis of so called "normal" immunoglobulins, fast response to ubiquitous microbial antigens, elimination of apoptotic cells, maintaining the homeostasis of an immune system.	All known function of B-cells

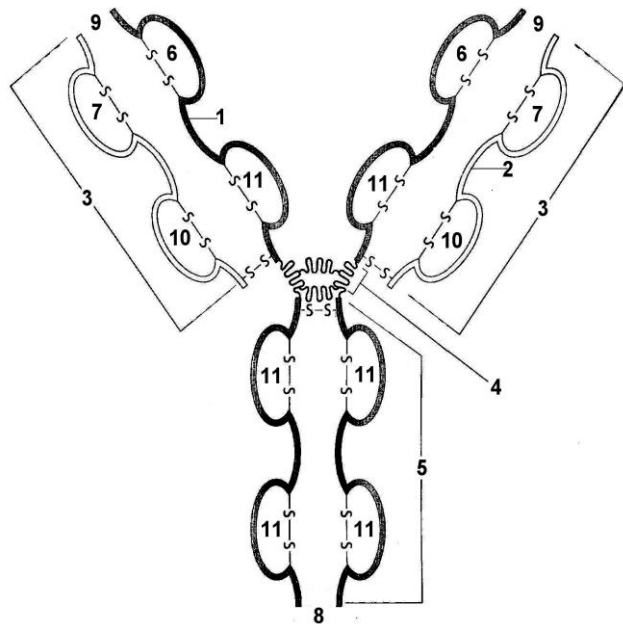

Fig. 11. Immunoglobulin structure

Write figures for elements of an immunoglobulin molecule indicated on scheme (fig.11)

Light chain (L)	
Variable domen of the light chain	
Constant domen of the light chain	
Heavy chain (H)	
Variable domen of the heavy chain	
Constant domen of the heavy chain	
Hinge fragment	
Fc- fragment	
Fab- fragment	
Active center	
Fc-receptor ligand	

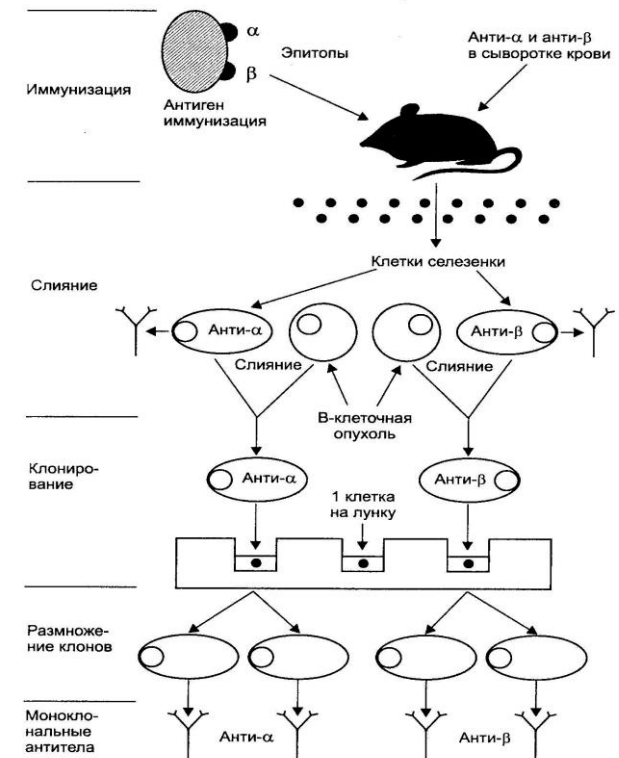
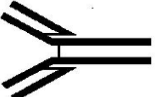
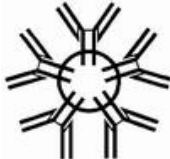
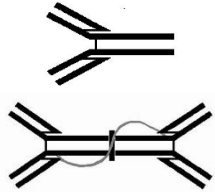
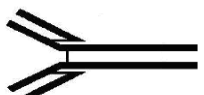
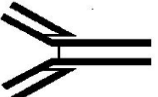
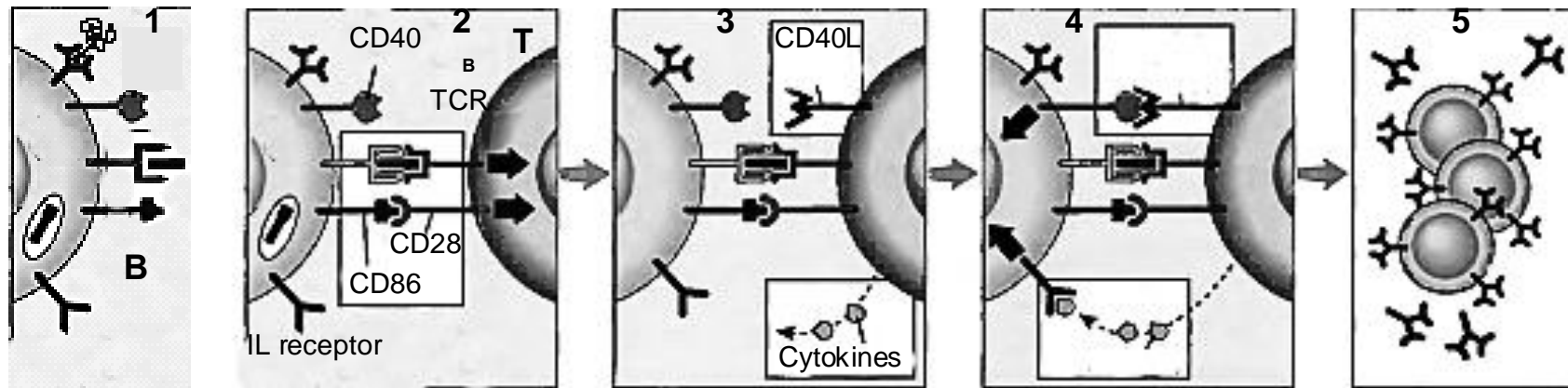

Fig. 12. Monoclonal immunoglobulins production

Write down the class of immunoglobulin according to characteristics indicated		
Structure	Characteristics	Ig class
	M = 154 KD. Concentration in the serum of adult ranges 7-18 g/L. The class includes four subclasses. Monomer, secreted through the placenta barrier. Highly specific, very effective in antitoxic immunity and against microbial agents.	Ig___
	M= 900 KDa. Concentration in the serum of adult ranges 0,4-2,2 g/L. Pentamer. The most active in primary immune response. The specificity is arbitrary low.	Ig___
	M= 160 KDa. Concentration in the serum of adult ranges 0,5-3,5 g/L. The class includes two subclasses. It exists as monomer, dimer or trimer. The immunoglobulin can be captured at inner surface of epithelial cells and transcytosed to the external surface of mucosa. It thus ensures the local immunity.	Ig___
	M = 190 KDa. Concentration in the serum of adult ranges pg-mcg/L. Monomer, highly cytophilic. Very important as an effector of the allergic reactions of an immediate type.	Ig___
	M= 185 KDa. Monomer, usually is expressed on the surface of B cells and plays an important role in B-cells differentiation.	Ig___

Primary humoral immune response development

Localization	Stages
I. Induction of T-effectors (helpers and other subpopulations)	
Tissue	1. APCs capture antigen (protein, microbes), process it and transport to regional lymphatic nodes.
Secondary lymphoid organs	2. APCs present antigens by endosome pathway to CD4+ naïve T-cells
	3. T-cells activate, proliferate and differentiate into effector cells (Th1, Th2, Th3, Tr1, Tr2, CD4+CD25+ etc.).
Blood, tissues	4. T-effectors recirculate through the organism.
II. Induction of B-effectors (plasmacytes)	
Tissues	1. APCs for B cells (follicular dendritic cells) capture antigen and transported it to secondary lymphoid organs (lymphatic nodes, Peyer patches, etc.). Antigen is not processed and conserved on DCs surface for a long time (up to year or longer).



1. B-lymphocyte captures antigen and presents it in complex with type II MHC molecule; due to activation the expression of CD86 increases on its surface.
2. T-effector receives activating signals (through the antigen recognition by TCR and costimulation by CD28).
3. Activated T-effector expresses CD40L (ligand) and secretes cytokines (IL4, 5, 6).
- 4-5. B-lymphocyte proliferates and differentiates to plasmacyte.

Secondary lymphoid organs, BM, blood	2. B-lymphocyte captures antigen, processes it and presents to T-effector. Specific T-effector is activated and activates B-cell with contact (CD40L) and distant (cytokines) interactions.
	3. B-lymphocyte proliferates, enters bloodstream and reaches secondary lymphoid organs and BM.
	4. B-lymphocytes turn to plasmacytes and produce immunoglobulins for some time (up to 3 months).
	5. Some B-lymphocytes return to the quiescent state and become the memory B-cells.
	III. Immunoglobulins realize their functions

Class 2 Humoral immune response

Selected methods for immune cells isolation and evaluation

Isolation of peripheral blood lymphocytes by Ficoll-Hypaque™ gradient.

The first step in studying lymphocytes is to isolate them so that their behavior can be analyzed *in vitro*. Human lymphocytes can be isolated most readily from peripheral blood by density centrifugation over a step gradient consisting of a mixture of the carbohydrate polymer Ficoll™ and the dense iodine-containing compound metrizamide (1,077). This yields a population of mononuclear cells at the interface that has been depleted of red blood cells and most polymorphonuclear leukocytes or granulocytes (granulocytes readily can be isolated as well by proper gradient =1,09-12). The resulting population, called peripheral blood mononuclear cells, consists mainly of lymphocytes and monocytes. Although this population is readily accessible, it is not necessarily representative of the lymphoid system, as only recirculating lymphocytes can be isolated from blood.

A particular cell population can be isolated from a sample or culture by binding to antibody-coated plastic surfaces, a technique known as panning, or by removing unwanted cells by treatment with specific antibody and complement to kill them. Cells can also be passed over columns of antibody-coated, nylon-coated steel wool and different populations differentially eluted. This technique extends affinity chromatography to cells, and is now a very popular way to separate cells. All these techniques can also be used as a pre-purification step prior to sorting out highly purified populations by FACS.

Isolation of lymphocytes from tissues other than blood.

In experimental animals, and occasionally in humans, lymphocytes are isolated from lymphoid organs, such as spleen, thymus, bone marrow, lymph nodes, or mucosal-associated lymphoid tissues, most commonly the palatine tonsils in humans (see Fig. 1.7). A specialized population of lymphocytes resides in surface epithelia; these cells are isolated by fractionating the epithelial layer after its detachment from the basement membrane. Finally, in situations where local immune responses are prominent, lymphocytes can be isolated from the site of the response itself. For example, in order to study the autoimmune reaction that is thought to be responsible for rheumatoid arthritis, an inflammatory response in joints, lymphocytes are isolated from the fluid aspirated from the inflamed joint space.

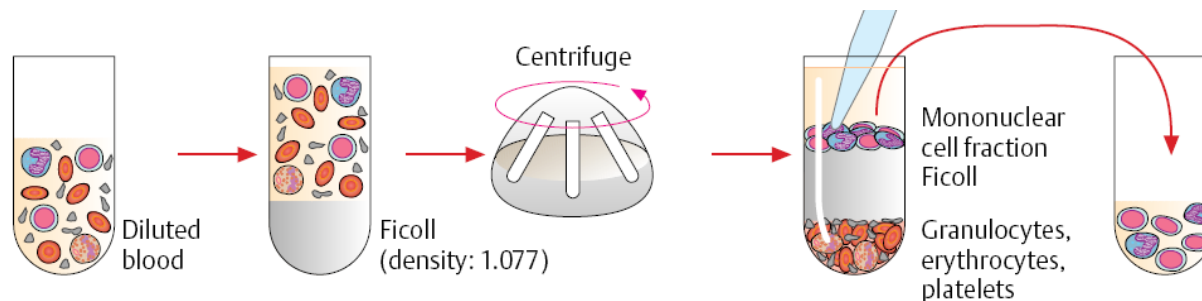

A. Isolation of mononuclear cells from peripheral blood

Plastic surface coated with antibodies

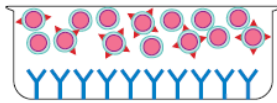

Antigen-bearing cells adhere

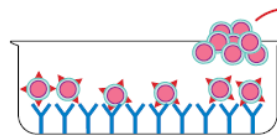

Antigen-negative cells

Antibody labeled with iron beads

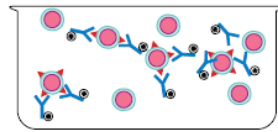

Antigen-bearing cells attracted by magnet

Magnet

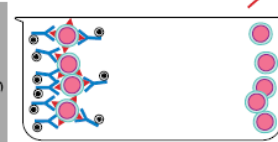

Antigen-negative cells

1. Panning method

2. Immunomagnetic separation

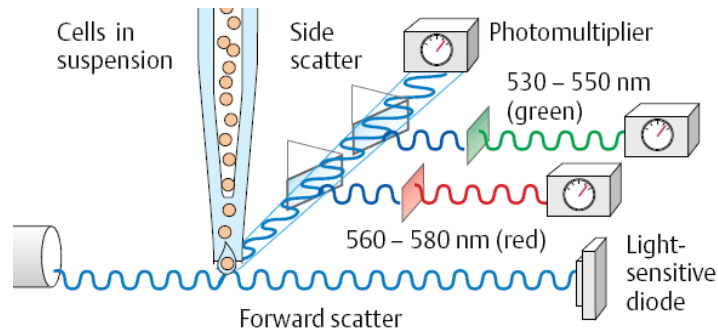

Flow cytometry

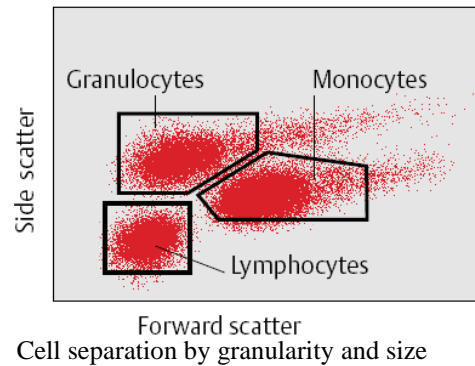

Flow cytometry. An analytical technique to phenotype cell populations. It requires a special apparatus, termed a flow cytometer, that can detect fluorescence on individual cells in suspension and thereby ascertain the number of cells that express the molecule binding a fluorescent probe. Cell suspensions are incubated with fluorescent-labeled monoclonal antibodies or other probes, and the quantity of probe bound by each cell in the population is assayed by passing the cells one at a time through a spectrofluorometer with a laser-generated incident beam. Sample cells flow single file past a narrowly focused excitation light beam that is used to probe the cell properties of interest. As the cells pass the focused excitation light beam, each cell scatters light and may emit fluorescent light, depending on whether or not it is labeled with a fluorochrome or is autofluorescent. Scattered light is measured in both the forward and perpendicular directions relative to the incident beam. The fluorescent emissions of the cell are measured in the perpendicular directions by a photosensitive detector. Measurements of light scatter and fluorescent

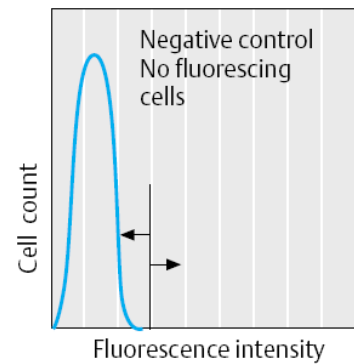

Fluorescence intensity histograms

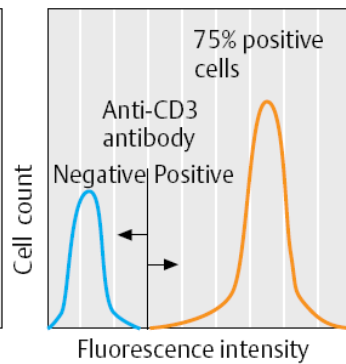

Cell separation by fluorescence

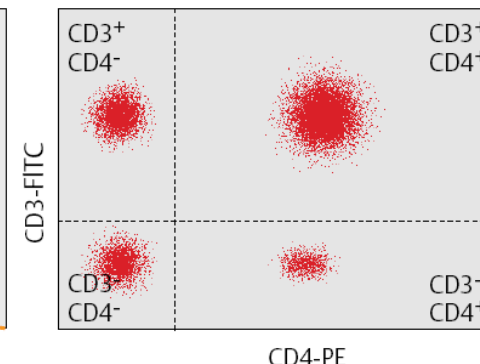

Dot-plot, two color analysis

emission intensities are used to characterize each cell as it is processed. Flow cytometry is a fast, accurate way to measure multiple characteristics of a single cell simultaneously. These objective measurements are made one cell at a time, at routine rates of 500 to 4000 particles per second in a moving fluid stream. A flow cytometer measures relative size (FSC), relative granularity or internal complexity (SSC), and relative fluorescence. Three-color flow cytometry is used to analyze blood cells by size, cytoplasmic granularity, and surface markers labeled with different fluorochromes. Flow cytometry serves as the basis for numerous very different, highly specialized assays. It is a multifactorial analysis technique and provides the capability for performing many of these assays simultaneously: immunophenotyping of surface and internal markers, determination of soluble factors (e.g. cytokines), phagocytosis assay, proliferation assay, apoptosis evaluation, cell cycle study and so on. This technology is of particular importance for leucosis diagnostics, transplantation of stem cells, clinical immunology problems.

Morphological and functional methods for B-cells system evaluation

- 1. B-cell quantity in the blood can be determined by flow cytometry**
- 2. B-cell function may be assayed by immunoglobulins concentration measurement in the serum: a) immunonephelometry**

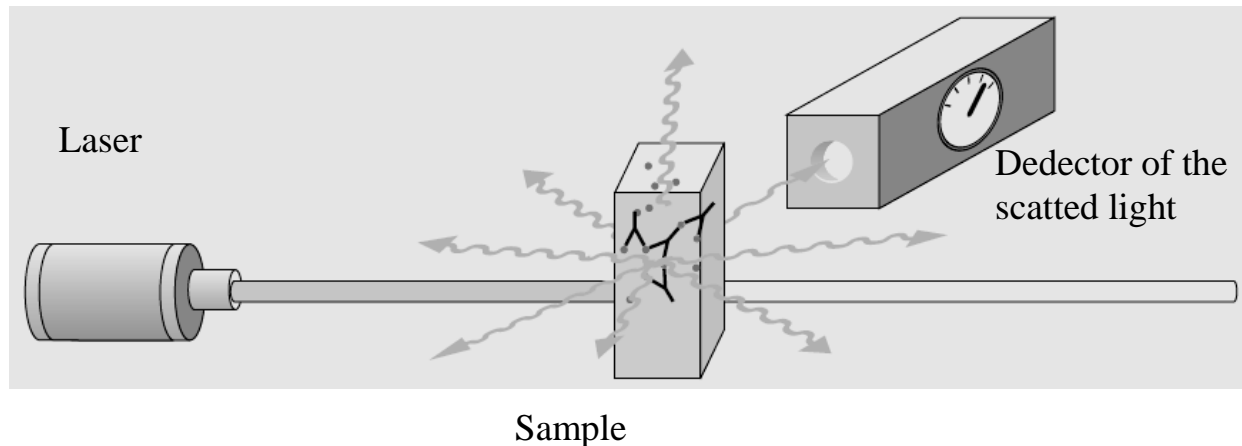

Immunonephelometry. A technique to assay proteins and other biological materials through the formation of a precipitate of antigen and homologous antibody. The assay depends on the turbidity or cloudiness of a suspension and is based on determination of the degree to which light is scattered when a helium–neon laser beam is directed through the suspension. Measurement is made at 340 to 360 nm using a spectrophotometer. The antigen concentration is ascertained using a standard curve devised from the light scatter produced by solutions of known antigen concentration. This method is used by many clinical immunology laboratories for the quantification of complement components and immunoglobulins in patients' sera or other body fluids.

Single (simple) radial immunodiffusion (SRID).

SRID is a technique to quantify antigens. Antibody is incorporated into agar in plates, wells are cut, and precise quantities of antigen are placed in the wells. The antigen is permitted to diffuse into the agar containing antibody and produce a ring of precipitation upon interaction with the antibody. As diffusion proceeds, an excess of antigen develops in the area of the precipitate which causes it to dissolve, only to form again at a greater distance from the site of origin. At the point where antigen and antibody reach equivalence in the agar, a precipitation ring is produced. The ring encloses an area proportional to the concentration of antigen measured 48 to 72 hours following diffusion. Standard curves are employed using known antigen standards. The antigen concentration is determined from the diameter of the precipitation ring. This method can detect as little as 1 to 3 $\mu\text{g/mL}$ of antigen. Known also as the Mancini technique.

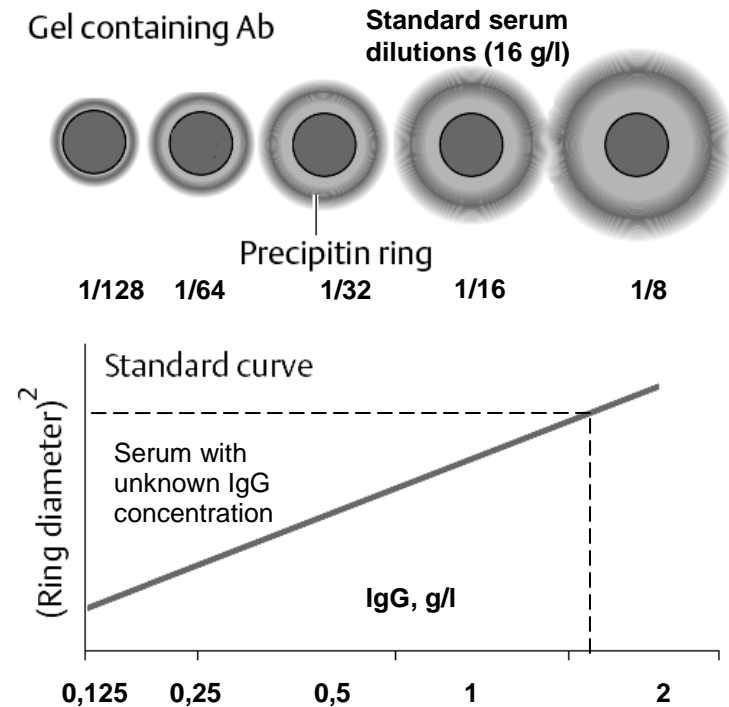
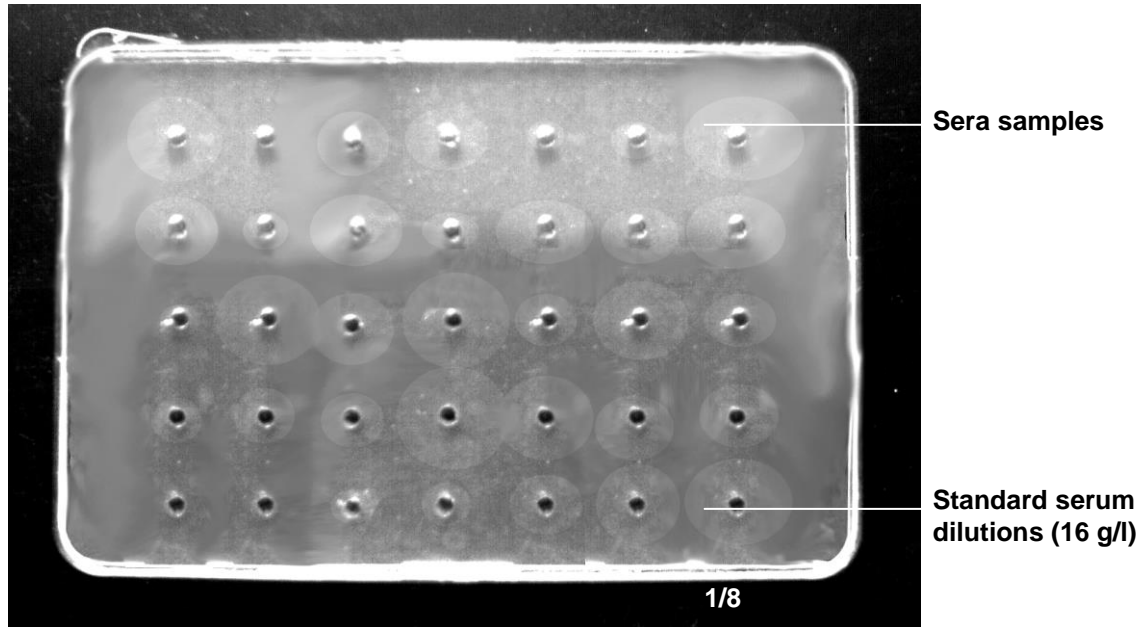



Practical class № 3 (11).

Date _____

The topic: Serologic reactions

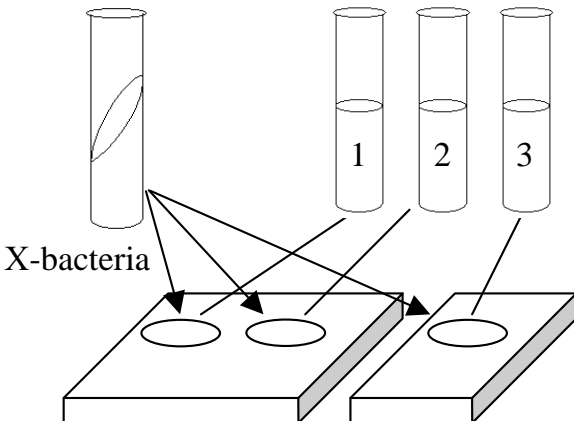
Suggested reading for self-study: Serological method, characteristics. Antibody titre. Diagnostic titre. Diagnosticum. Diagnostic serum. Agglutination, passive agglutination, reversed passive agglutination, latex agglutination. Precipitation. Ring precipitation test, double immunodiffusion in a gel (by Ouchterlony), simple radial immunodiffusion in a gel (by Mancini), immunoelectrophoresis, electroimmunodiffusion.

Laboratory exercises	Laboratory report
<p>1. Perform slide agglutination test to identify an X-bacteria.</p>	<div style="display: flex; justify-content: space-around; align-items: center;">  <div style="margin-left: 20px;"> <ol style="list-style-type: none"> 1. Serum against <i>S. typhi</i> 2. Serum against <i>E. coli</i> 3. Saline solution <p>Conclusion: X-bacteria is _____</p> </div> </div>
<p>2. Determine the result of passive hemagglutination reaction.</p>	<div style="display: flex; justify-content: space-around; align-items: center;"> <div style="text-align: center;"> <p>1/10 1/20 1/40 1/80 1/160 KC KA</p>  </div> <div style="margin-left: 20px;"> <p>Conclusion: _____</p> </div> </div>

3. Perform the ring precipitation reaction to identify the X-antigen

Serum against human proteins Serum against horse proteins Normal rabbit serum X-protein

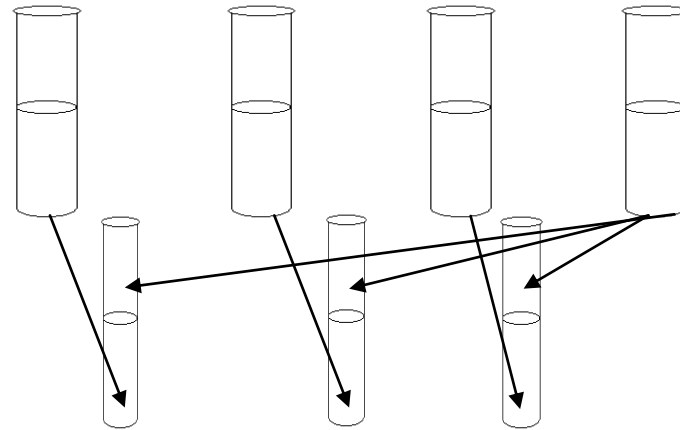

Conclusion: _____

4. Determine the result of tube agglutination reaction

1/50 1/100 1/200 1/400 1/800 KC KA

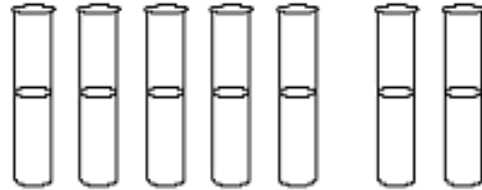

Conclusion: _____

Signature of the tutor _____

Additional and self-testing materials

1. Comparative characteristics of serological reactions		
Reaction	Specificity	Sensitivity
Agglutination	Variable (usually low due to antigen origin: surface antigens of bacterial cell)	10^{-4} - 10^{-5} (low titers are caused by vast quantity of antigens of weak immunogenicity per particular bacteria preparation)
Complement fixation test	Variable (usually high in the case of viral antigens)	10^{-5} - 10^{-6}
Precipitation	High (unique highly immunogenic protein antigens)	10^{-5} - 10^{-7} (arbitrary low because of tiny dimensions of resulting immune complexes)
Passive agglutination	High, -/-	10^{-6} - 10^{-8} (large resulting immune complexes)
IF	High (unspecific binding is critical)	10^{-7} - 10^{-8} (low antigen concentration and unspecific binding are critical)
ELISA	High (last generations of ELISA use recombinant (or synthetic) antigens and monoclonal immunoglobulins)	10^{-9} - 10^{-11} (unspecific binding)
RIA	High, -/-	10^{-10} - 10^{-12} , (the highest sensitivity due to very low background)
Immunoblotting	High (usually confirmatory method: determines antibodies to particular important determinants of the whole antigen)	10^{-7} - 10^{-9} , (needs arbitrary high volume of serum)

2. The scheme of tube agglutination test

A. Make serial dilutions of the serum according to table:

a) mark and place necessary tubes into the rack

б) place saline solution according to table

в) place serum into first, second and seventh tubes. Then mix liquid in the second tube and transfer 0,5 ml to the next tube. Change the tip of a dosator each time. After transfer and mixing of 5th tube, take away and dispose 0,5 ml of liquid;

г) place 0,5 ml of diagnosticum in each tube except serum control tube;

д) shake briefly and incubate at 37°C for 2 hours;

е) register the preliminary results;

ж) leave tubes for 18-20 hours (overnight) at room temperature (20-25 ° C);

з) register the final results.

Reagents	1	2	3	4	5	6	7
	Saline solution	1/50	1/100	1/200	1/400	1/800	KA
Serum	0,5	0,5	0,5	0,5	0,5	-	0,5
Diagnosticum	0,5	0,5	0,5	0,5	0,5	0,5	-
Incubation 2 hours at 37 ° C							
Results							
Incubation 18-20 hours at 20-25 ° C							
Results							

0,5 ml

B. The agglutination reaction results are registered by four plus system:

- ++++ massive sediment, antigen suspension (dust like) is not visible;
- +++ average sediment, little antigen suspension
- ++ sediment and antigen suspension equally expressed
- + slight sediment visible, dense antigen suspension
- no sediment, antigen suspension as dense as in the antigen control tube

B. Depending on the antigen nature one can distinguish:

- Large flakes sediment, usually developed when bacteria are agglutinated by antiserum against flagella;
- Low corned sediment, usually developed when bacteria are agglutinated by antiserum against cell wall antigens.





Practical class № 4 (12).

Date _____

The topic: Serologic reactions, part II

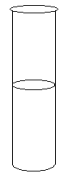
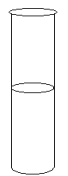
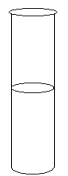
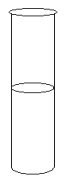
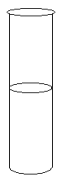
Suggested reading for self-study: Immune lysis reactions. Complement fixation test: ingredients, implementation, characteristics.

Immunofluorescence test: direct and indirect variants. Immunoenzyme test. ELISA. Radioimmune test.

Laboratory exercises	Laboratory report									
1. Perform a complement fixation test	Ingredients	1 1:10	2 1:20	3 1:40	4 1:80	5 1:160	KC	KA	Hemolytic system: 4 ml 3% erythrocytes suspension + 4 ml hemolytic serum	
	Saline	-	0,5	0,5	0,5	0,5	0,5	0,5		
	Serum	0,5	0,5	-	-	-	0,5	-		
	Diagnosticum	0,5	0,5	0,5	0,5	0,5	-	0,5		
	Complement	0,5	0,5	0,5	0,5	0,5	0,5	0,5		
	Incubation for 45 min at 37° C									
	Hemolytic system	1,0	1,0	1,0	1,0	1,0	1,0	1,0		
	Incubation for 30 min at 37° C									
	Registration of results									
	Conclusion: _____									

2. Perform ELISA for HBs antigen detection in donor serum:

a) place 100 mcl of control serum and samples according to test scheme;

б) place 50 mcl of conjugate in each well;

в) incubate for 1 hour at 37° C;

г) wash the strip 5 times;

д) place 100 mcl of chromogen in each well;

е) incubate for 30 min at 37° C;

ж) place 100 mcl of stop-reagent in each well;

з) measure the strip on ELISA reader and print out the results;

и) fill in the report: check the test validity and make the final conclusion about results.

REPORT

ELISA test for HBs-Ag detection in the serum

1. Date
2. Name of technician
3. Scheme of the test

	1	2	3	4	5	6	7	8	9	10	11	12
A	Negative control											
B	Negative control											
C	Low positive control											
D	High positive control											
E	Sample № 1											
F	Sample № 2											
G	Sample № 3											
H	Sample № 4											

4. Test validity:

a) average OD of negative controls must be $< 0,15$

$\overline{OD(NC)}$ (negative controls) =

б) OD negative controls must range from 0,6 to 1,4 of average $\overline{OD(NC)}$

$0,6 \overline{OD(NC)}$ =

$1,4 \overline{OD(NC)}$ =

в) average positive controls OD must be more than four times as much as $\overline{OD(NC)}$:

average $OD(PC) / \overline{OD(NC)}$ =

г) Low positive control OD must be higher than cut-off level

5. Cut-off calculation:

Cut-off = $OD(NC) + 0,04$

6. Results interpretation:

Sample	OD	Conclusion
1		
2		
3		
4		

Doctor on duty

Signature of the tutor _____

Write down the following definitions:

Titer – _____

Diagnostic titer – _____

Diagnosticum - _____

Diagnostic serum – _____

Draw the scheme of immunofluorescence reaction

Direct variant

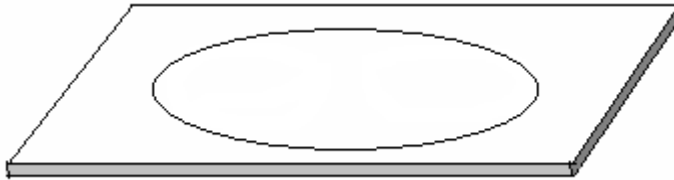

Indirect variant



Class 3, 4. Serologic reactions

AGGLUTINATION. The combination of soluble antibody with particulate antigens in an aqueous medium containing electrolyte, such as erythrocytes, latex particles bearing antigen, or bacterial cells, to form an aggregate that may be viewed microscopically or macroscopically. If antibody is linked to insoluble beads or particles, they may be agglutinated by soluble antigen through reverse agglutination. Agglutination is the basis for multiple serological reactions, including blood grouping, diagnosis of infectious diseases, rheumatoid arthritis (RA) testing, etc. To carry out an agglutination reaction, serial dilutions of antibody are prepared, and a constant quantity of particulate antigen is added to each antibody dilution. Red blood cells may serve as carriers for adsorbed antigen (e.g., the tanned red cell or *bisdiazotized red cell technique*). Like precipitation, agglutination is a secondary manifestation of antigen–antibody interaction. As specific antibody crosslinks particulate antigens, aggregates that form become

macroscopically visible and settle out of suspension. Thus, the agglutination reaction has a sensitivity 10 to 500 times greater than that of the precipitin test with respect to antibody detection.

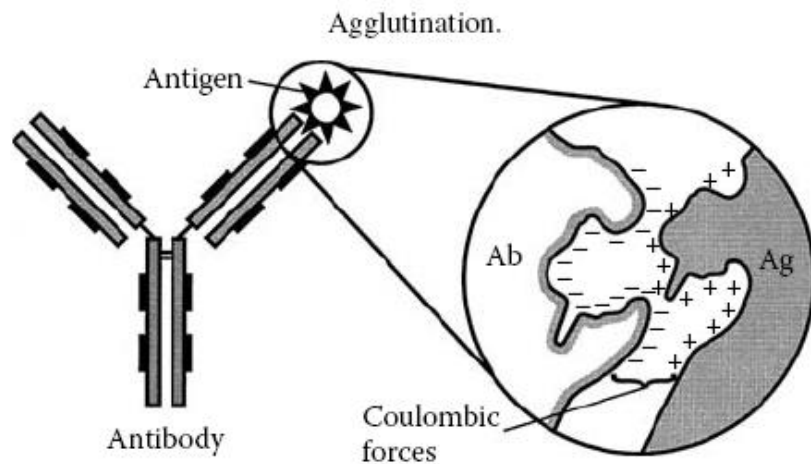
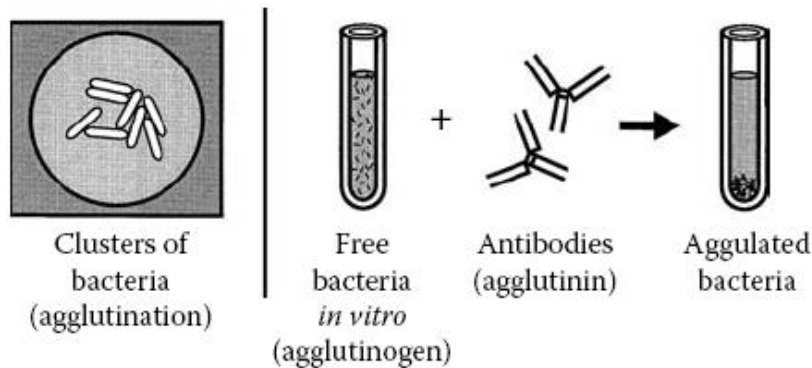

Agglutinin. An antibody that interacts with antigen on the surfaces of particles such as erythrocytes, bacteria, or latex cubes to cause their aggregation or agglutination in an aqueous environment containing electrolyte. Substances other than agglutinin antibody that cause agglutination or aggregation of certain specificities of red blood cells include hemagglutinating viruses and lectins.

Agglutigen. Antigens on the surfaces of particles such as red blood cells that react with the antibody known as agglutinin to produce aggregation or agglutination. The most widely known agglutinogens are those of the ABO and related blood group systems.

Slide agglutination test. The aggregation of particulate antigen using red blood cells, microorganisms, or latex particles coated with antigen within 30 seconds following contact with specific antibody. The reactants are usually mixed by rocking the slide back and forth, and agglutination is observed macroscopically and microscopically. The test has been widely used for screening but is unable to distinguish reactions produced by cross reacting antibodies that can be ruled out in a tube test that allows dilution of the antiserum.

Tube agglutination test. An agglutination assay that consists of serial dilutions of antiserum in serological tubes to which a particulate antigen such as a microorganism is added.

Antibody titer. The amount or level of circulating antibody in a patient with an infectious disease. For example, the reciprocal of the highest dilution of serum (containing antibodies) that reacts with antigen (e.g. produces an agglutination) is the titer. Two separate Antibodies titer determinations in two weeks are required to reflect an individual's exposure to an infectious agent.

Agglutination titer. The highest dilution of a serum that causes clumping of particles such as bacteria. Titer is an approximation of the antibody activity in each unit volume of a serum sample. The term is used in serological reactions and is determined by preparing serial dilutions of antibody to which a constant amount of antigen is added. The end point is the highest dilution of antiserum in which a visible reaction with antigen, e.g., agglutination, can be detected. The titer is expressed as the reciprocal of the serum dilution that defines the endpoint. If agglutination occurs in the tube containing a 1:240 dilution, the antibody titer is said to be 240. Thus, the serum would contain approximately 240 units of antibody per milliliter of antiserum. The titer provides only an estimate of antibody activity. For absolute amounts of antibody, quantitative precipitation or other methods must be employed.

Examples of RA application in medical practice:

Widal reaction Bacterial agglutination test used to diagnose enteric infections caused by *Salmonella*. Doubling dilutions of patient serum are combined with a suspension of microorganisms known to cause enteric fever such as *S. typhi*, *S. paratyphi* B, and *S. paratyphi* A and C. The test microorganisms should be motile and smooth and in the specific phase. Formalin-treated suspensions are used to assay H agglutinins, and alcohol-treated suspensions assay O agglutinin. The Widal test is positive after the 10th day of the disease. Results may be false-positive if an individual previously received a TAB vaccine. Thus, it is important to repeat the test and observe a rising titer rather than merely observe a single positive test. Widal originally described the test to diagnose *S. paratyphi* B infection.

ABO blood group system The first described of the human blood groups based upon carbohydrate alloantigens present on red cell membranes. Anti-A or anti-B isoagglutinins (alloantibodies) are present only in the blood sera of individuals not possessing that specificity; that is, anti-A is found in the sera of group B individuals, and anti-B is found in the sera of group A individuals. This serves as the basis for grouping humans into phenotypes designated A, B, AB, and O. Type AB subjects possess neither anti-A nor anti-B antibodies, whereas group O persons have both anti-A and anti-B antibodies in their serum. Blood group methodology to determine the ABO blood type makes use of the agglutination reaction. The ABO system remains the most important in the transfusion of blood and is also critical in organ transplantation. Epitopes of the ABO system are found on oligosaccharide terminal sugars. The genes designated A/B, Se, H, and Le govern the formation of these epitopes and of the Lewis (Le) antigens. The two precursor substances type I and type II differ only in that the terminal galactose is joined to the penultimate *N*-acetylglucosamine in the b 1–3 linkage in type I chains, but in the b 1–4 linkage in type II chains.

PRECIPITATION

Precipitation. Following the union of soluble macromolecular antigen with a homologous antibody in the presence of electrolytes *in vitro* and *in vivo* that occurs within seconds after contact, complexes of increasing density form in a lattice arrangement and settle out of solution, as in the precipitation or precipitin reaction. The materials needed for a precipitin reaction include antigen, antibody, and electrolyte. The reaction of soluble antigen and antibody in the precipitin test may be observed in liquid or gel media. The reaction in liquid media may be qualitative or quantitative. Following discovery of the precipitin reaction by Kraus, quantitative and semiquantitative measurements of antibody could be made. The term *precipitinogen* is sometimes employed to designate the antigen, and *precipitin* is the antibody in a precipitation reaction.

Simple immunodiffusion test

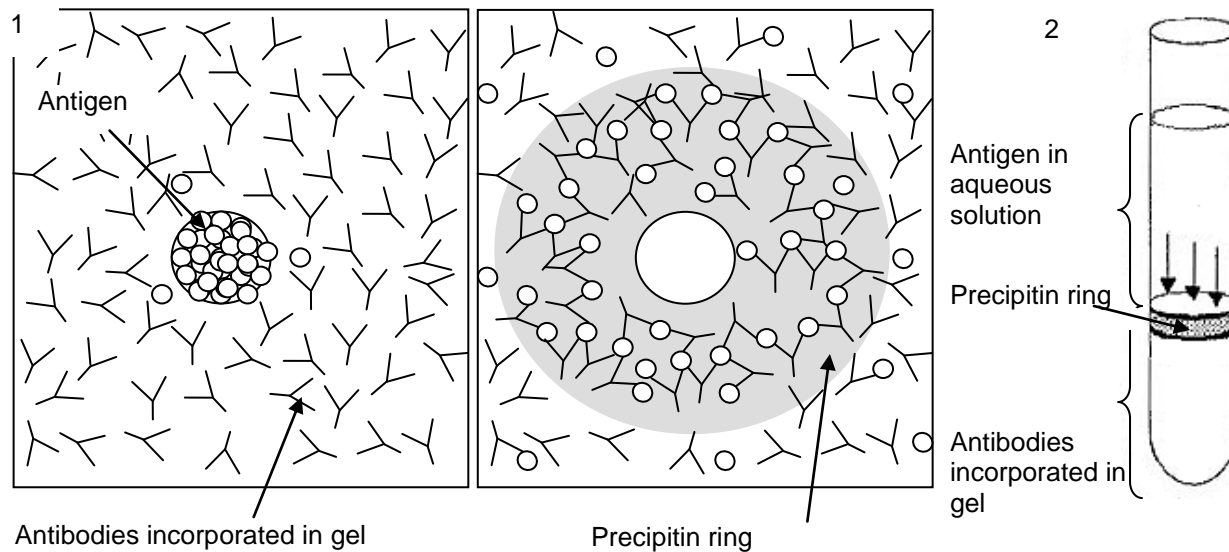

(1) A technique in which antibody is incorporated into agar gel and antigen is placed in a well cut into the surface of the antibody-containing agar. Following diffusion of the antigen into the agar, a ring of precipitation forms at the point where antigen and antibody reach equivalence. The diameter of the ring is used to quantify the antigen concentration by comparison with antigen standards. (2) The addition of antigen to a tube containing gel into which specific antibody has been incorporated. Lines of precipitation form at the site of interaction between equivalent quantities of antigen and antibody.

Ring precipitation test

Lancefield precipitation test. A ring precipitation test developed by Rebecca Lancefield to classify streptococci according to their group-specific polysaccharides. The polysaccharide antigen is derived by treatment of cultures of the microorganisms with HCl, formimide, or a *Streptomyces albus* enzyme. Antiserum is first placed into a serological tube, followed by layering the polysaccharide antigen over it. A positive reaction is indicated by precipitation at the interface.

Double immunodiffusion test

Ouchterlony test. A double diffusion in a gel type precipitation test. Antigen and antibody solutions are placed in separate wells cut into an agar plate prepared with electrolyte. As the antigen and antibody diffuse through the gel medium, a line of precipitation forms at the point of contact between antigen and antibody. Results are expressed as a reaction of identity, reaction of partial identity, or reaction of nonidentity (refer to those entries for further details).

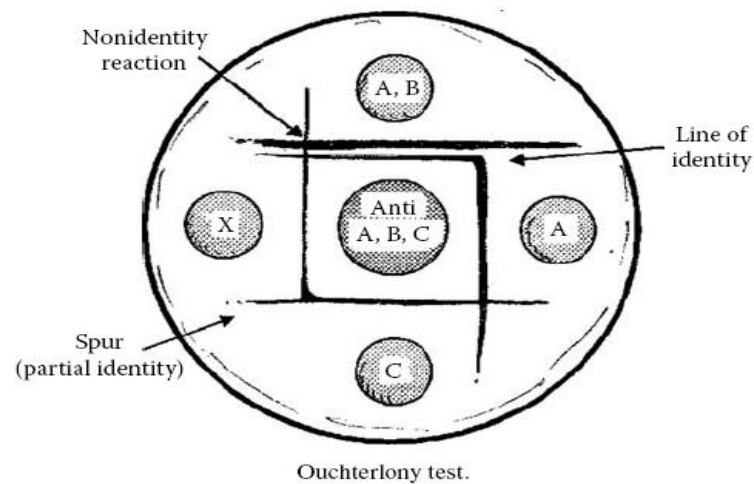

Electroimmunodiffusion. A double-diffusion in-gel method in which antigen and antibody are forced toward one another in an electrical field. Precipitation occurs at the site of their interaction. Also called counter immunoelectrophoresis.

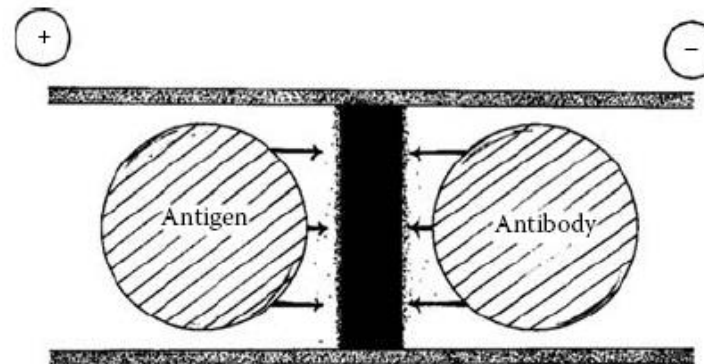

Electroimmunodiffusion.

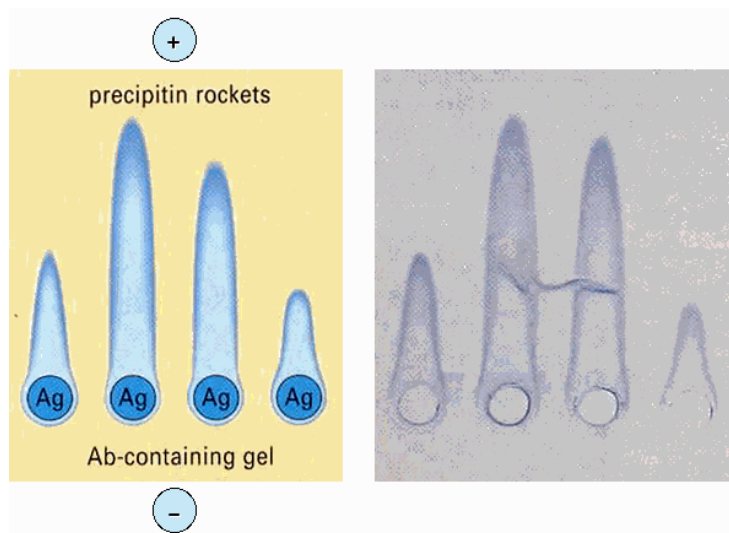

Rocket electrophoresis. The electrophoresis of antigen into an agar-containing specific antibody. Through electroimmunodiffusion, lines of precipitation formed in the agar by the antigen–antibody interaction assume the shape of a rocket. The antigen concentration can be quantified because the size of the rocket-like area is proportional to the antigen concentration. This can be deduced by comparing with antigen standards. This technique has the advantage of speed. It can be completed within hours instead of longer periods required for single radial immunodiffusion. Also called Laurell rocket electrophoresis.

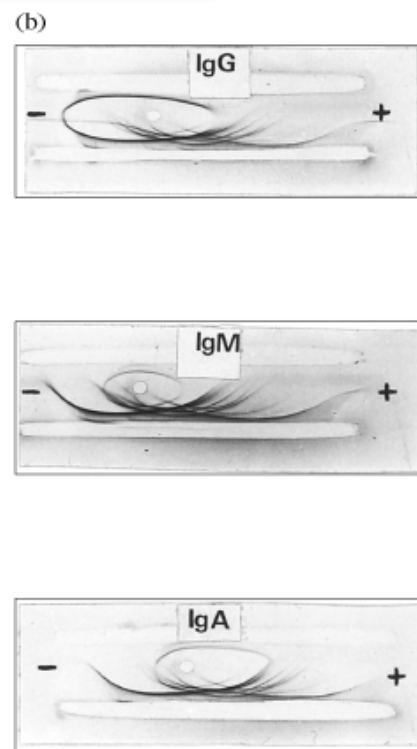
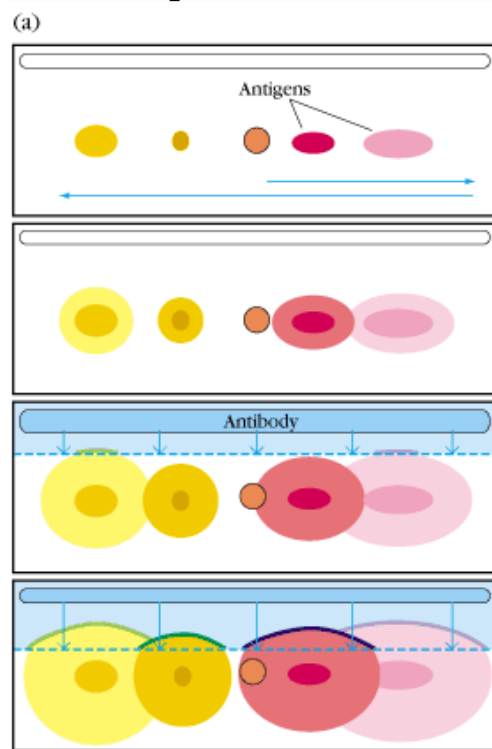

Immunoelectrophoresis (IEP or IE). A method to identify antigens on the basis of their electrophoretic mobility, diffusion in gel, and formation of precipitation arcs with specific antibody. Electrophoresis in gel is combined with diffusion of a specific antibody in a gel medium containing electrolyte to identify separated antigenic substances. This allows determination of the presence or absence of immunoglobulin molecules of various classes in a serum sample. One percent agar containing electrolyte is layered onto microscope slides and allowed to gel, and patterns of appropriate troughs and wells are cut in the solidified medium. Antigen to be identified is placed in the circular wells cut into the agar medium. This is followed by electrophoresis that permits separation of the antigenic components according to their electrophoretic mobility. Antiserum is placed in a long trough in the center of the slide. After antibody has diffused through the agar toward each separated antigen, precipitin arcs form where the antigen and antibody interact. Abnormal amounts of immunoglobulins result in changes in the shape and position of precipitin arcs when compared with the arcs formed by antibody against normal human serum components. With monoclonal gammopathies, the arcs become broad, bulged, and displaced. The absence of immunoglobulin classes such as those found in certain immunodeficiencies can also be detected with IEP.

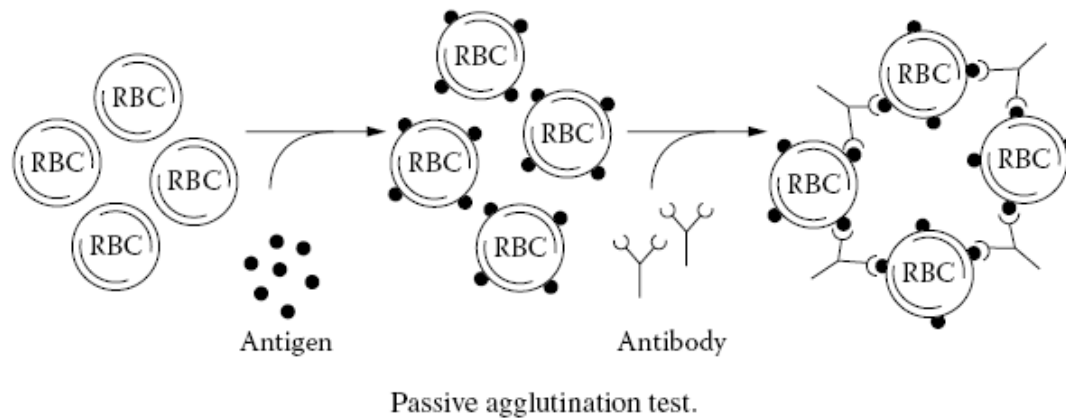

PASSIVE AGGLUTINATION. The aggregation of particles with soluble antigens adsorbed to their surfaces by a homologous antibody. The soluble antigen may be linked to the particle surface through covalent bonds rather than by mere adsorption. Red blood cells, latex, bentonite, or collodion particles may be used as carriers for antigen molecules adsorbed to their surfaces. When a red blood cell is used as a carrier particle, its surface has to be altered to facilitate maximal adsorption of the antigen to its surface. Several techniques are employed to accomplish this. One is the tanned red blood cell technique, which involves treating the cells with a tannic acid solution that alters their surfaces in a manner favoring the adsorption of added soluble antigen. A second method is the treatment of red cell preparations with other chemicals such as *bis*-diazotized benzidine. With this passive agglutination technique, even relatively minute quantities of soluble antigens may be detected by the homologous antibody-agglutinating carrier cells on which they are adsorbed. Because red blood cells are the most commonly employed particles, the technique is referred to as passive hemagglutination. Latex particles are used in the rheumatoid arthritis (RA) test, in which pooled immunoglobulin G (IgG) molecules are adsorbed to latex particles and reacted with the sera of patients with rheumatoid arthritis that contain rheumatoid factor (IgM anti-IgG antibody) to produce agglutination. Polysaccharide antigens will stick to red blood cells without treatment. When proteins are used, however, covalent linkages are required.

Principle: competition between test system (Ag + Ab) and indicator system (erythrocytes loaded with test Ab) for complement

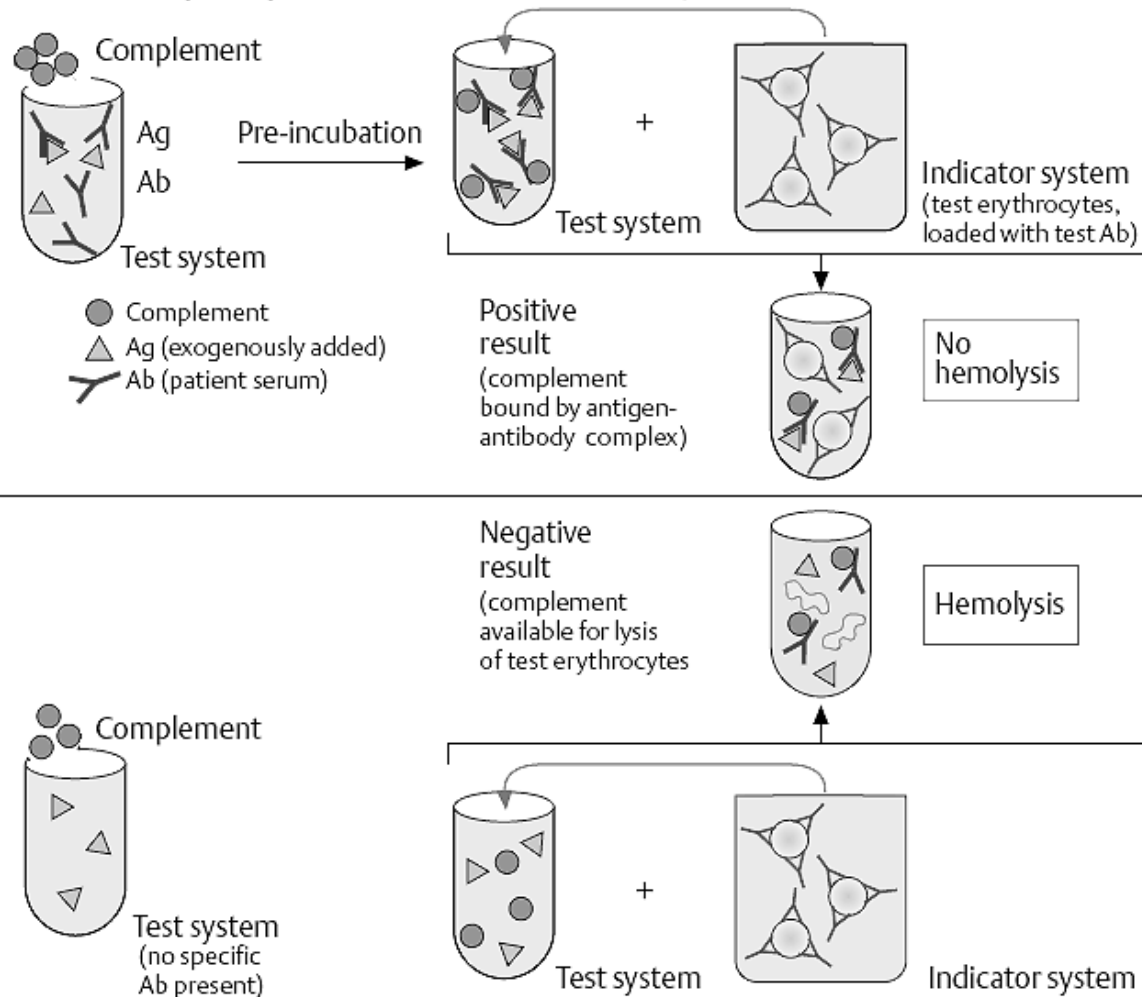

Complement fixation assay. A serologic test based on the fixation of complement by antigen–antibody complexes. It has been applied to many antigen–antibody systems and was widely used earlier as a serologic test for syphilis. The test is characterized by high sensitivity and specificity (depending on the nature of antigens and antibodies of the main (test) system). The test are of value for virology, when high quality antigen (viral particles glycoproteins) can be easily generated in cell culture and used for the diagnostics of infection (even in the case of unknown viral infection for which modern diagnostic means are not developed) or for virus identification with the help of diagnostic antisera.

Enzyme-linked immunosorbent assay (ELISA). A binder-ligand immunoassay that employs an enzyme linked to either anti-immunoglobulin or antibody specific for antigen and detects either antibody or antigen. This method is based on the sandwich or double-layer technique in which an enzyme rather than a fluorochrome is used as the label. Antibody is attached to the plastic tube, well, or bead surface to which the antigen-containing test sample is added. If antibody is sought in the test sample, the antigen should be attached to the plastic surface. Following antigen- antibody interaction, the enzyme-anti-immunoglobulin conjugate is added. The ELISA test is read by incubating the reactants with an appropriate substrate to yield a colored product that is measured in a spectrophotometer. Alkaline phosphatase and horseradish peroxidase enzymes are often employed. ELISA methods have replaced many radioimmunoassays because of the lower cost and safety, speed, and simplicity to perform.

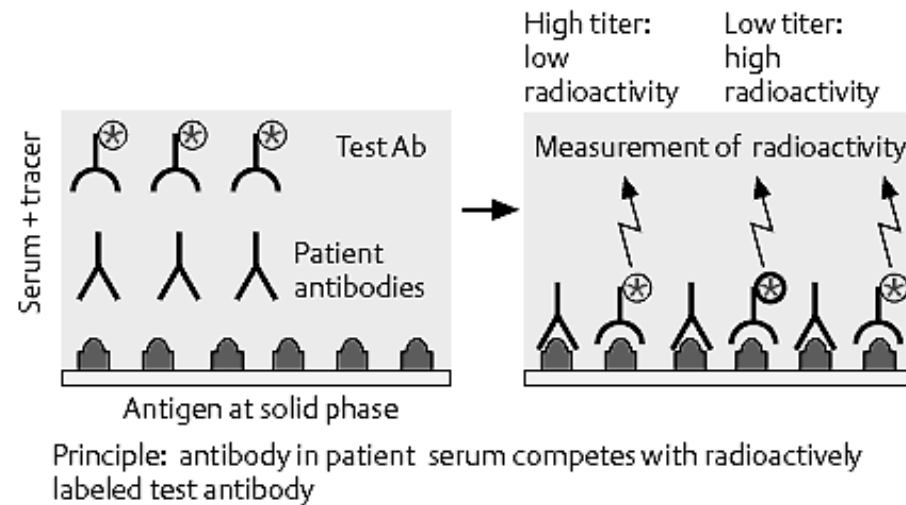
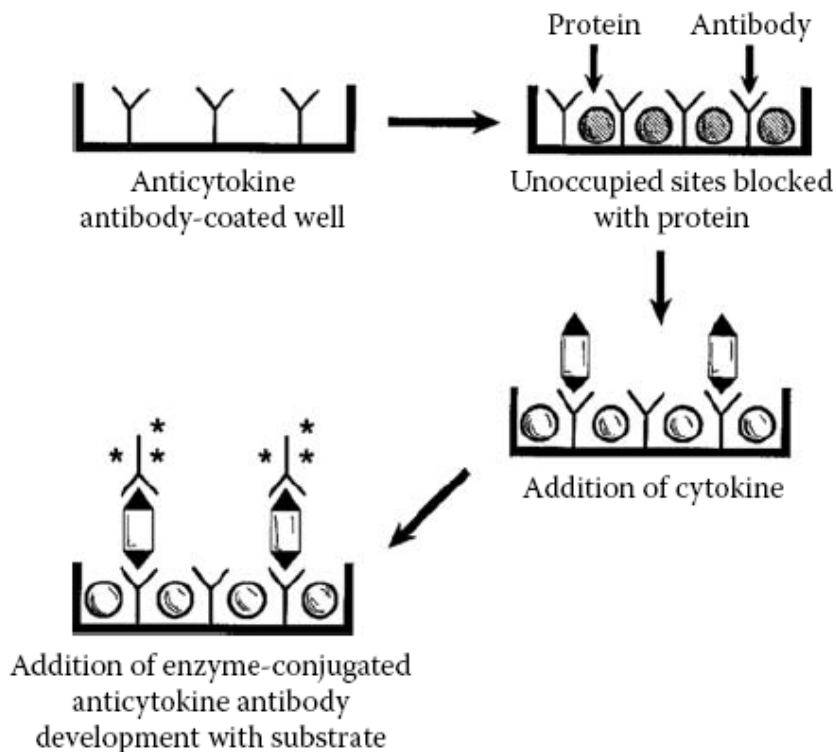

Radioimmunoassay (RIA). A binder ligand technique used to assay antigen or antibody; it is based on competitive inhibition by a radiolabeled antigen of the binding of an unlabeled antigen to specific antibodies. Minute quantities of enzymes, hormones, and other immunogenic substances can be assayed by RIA. Enzyme immunoassays have largely replaced RIAs because of the problems associated with radioisotope regulation and disposal.

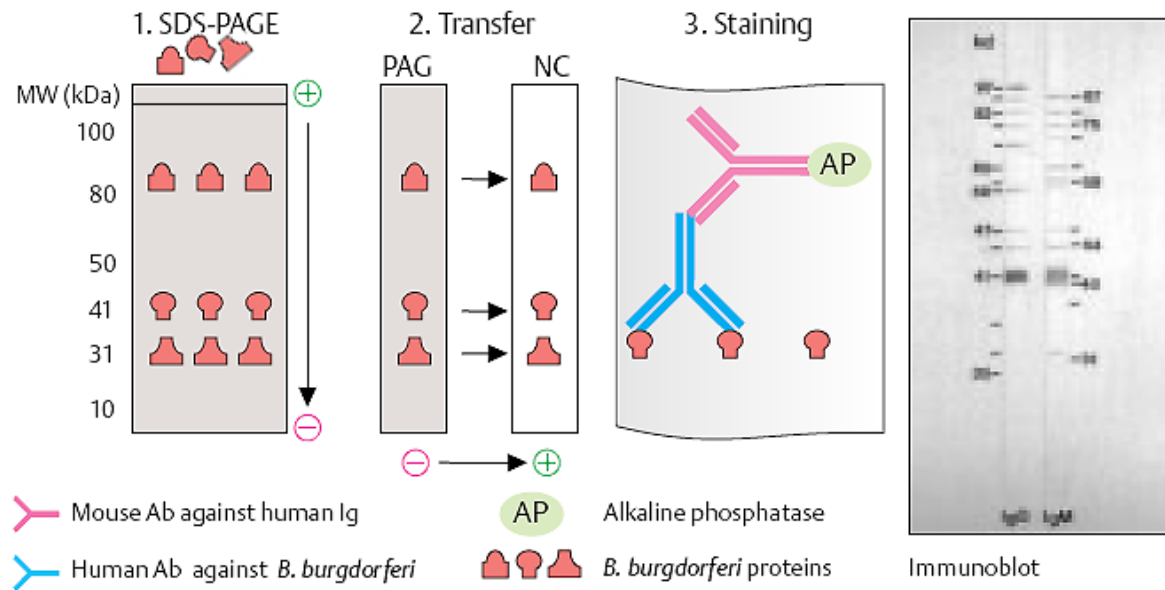

Western blot (immunoblot). A method to identify antibodies against proteins of precise molecular weight. It is widely used as a confirmatory test for HIV-1 antibody following screening via the ELISA assay. Following separation of proteins by one- or twodimensional electrophoresis, they are blotted or transferred to a nitrocellulose or nylon membrane followed by exposure to biotinylated or radioisotope-labeled antibody; the antigen under investigation is revealed by either a color reaction or autoradiography, respectively.

RAST (radioallergosorbent test). A technique to detect specific IgE antibodies in serum. This solid phase method involves binding of the allergen–antigen complex to an insoluble support such as dextran particles or Sepharose®. The serum is then passed over the allergen support complex that permits specific IgE antibodies in the serum to bind with the allergen. After washing to remove nonreactive protein, radiolabeled anti-human IgE antibody is then placed in contact with the insoluble support, where it reacts with the bound IgE antibody. Both the allergen and anti-IgE antibody must be present in excess for the test to be accurate. The amount of radioactivity on the beads is proportional to the quantity of serum antibody that is allergen-specific.

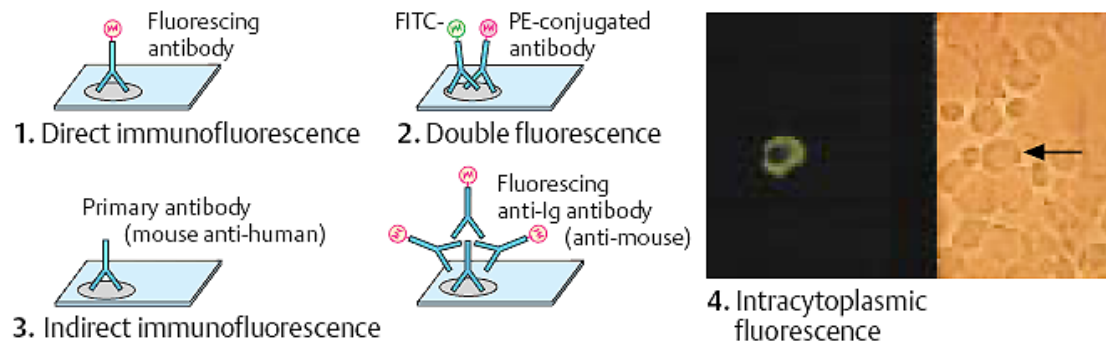
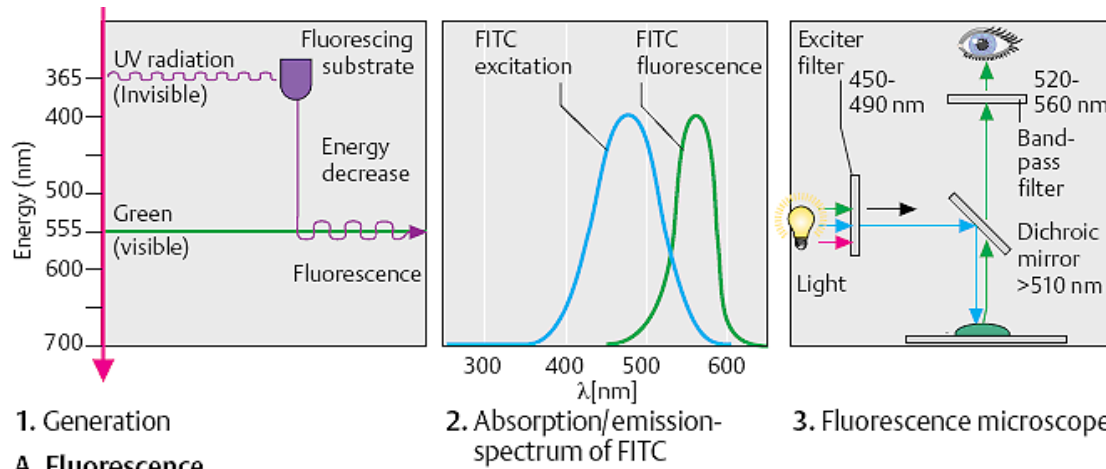

glycerol and a cover slip, the smear may be examined with a fluorescence light microscope. In the indirect test, which is more sensitive, a smear or tissue section is first flooded with unlabeled antibody specific for the antigen sought. After washing, fluorescein-labeled antiimmunoglobulin of the species of the primary antibody is layered over the section. After appropriate incubation and washing, the section is cover slipped and examined as in the direct method. Variations such as complement staining are also available. The indirect method is more sensitive and considerably less expensive; one fluorochrome-labeled antiimmunoglobulin may be used with multiple primary antibodies specific for a battery of antigens.

Immunofluorescence. A method for the detection of antigen or antibody in cells or tissue sections through the use of fluorescent labels (fluorochromes) by fluorescent light microscopic examination. The most commonly used fluorochromes are fluorescein isothiocyanate, which imparts an apple-green fluorescence, and rhodamine B isothiocyanate, which imparts a reddish-orange tint. This method, developed by Albert Coons in the 1940s, has a wide application in diagnostic medicine and research. In addition to antigens and antibodies, complements and other immune mediators may also be detected by this method. It is based on the principle that, following adsorption of light by molecules, cells or tissues dispose of their increased energy by an emission of light of longer wavelength. Several immunofluorescence techniques are available. In the direct test, smears of the substance to be examined are fixed with heat or methanol and followed by flooding with a fluorochrome-antibody conjugate. This is followed by incubating in a moist chamber for 30 to 60 minutes at 37°C, after which the smear is washed first in buffered saline for 5 to 10 minutes and then in tap water for another 5 to 10 minutes. The washing procedures remove uncombined conjugated globulin. After adding a small drop of buffered

Practical class № 5 (13).

Date _____

The topic: Cellular immune response. Allergy

<p>Suggested reading for self-study: Cellular immune response and its phenomena. T lymphocyte system. T-cell markers. TCR. Genetic control of TCR diversity. T-lymphocytes subpopulations: helpers, killers, DTH-effectors, regulators. T helpers of 1, 2, 3 and 17 types. Methods for evaluation of T-lymphocytes system: quantitative and functional tests. Allergy, stages, types. Immediate type of hypersensitivity mechanisms: mediator type (I), cytotoxic type (II), immune complex type (III). Delayed type of hypersensitivity mechanism (IV). Drug allergy. Methods for allergic conditions diagnostics.</p>	<p>[1]: p.76-95; 99-105; 144-172; 105-117.</p>
---	--

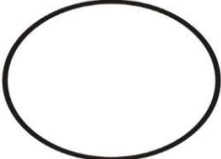
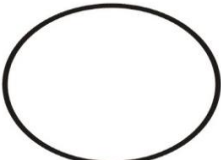
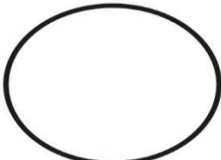
Laboratory exercises	Laboratory report
<p>Determine the quantity of CD3+ T-lymphocytes in ready made slide by immune rosettes method (Romanowsky-Giemsa stain).</p>	<div style="text-align: center;">  </div> <p>Smear _____ Stain _____</p>
<p>Complete the drawings of slides seen in demonstration room::</p> <ol style="list-style-type: none"> Immune rosettes method for T-cell quantity determination (Romanowsky-Giemsa stain). Blast transformation of lymphocytes (Romanowsky-Giemsa stain). Degranulation of mast-cells (Romanowsky-Giemsa stain). 	<div style="display: flex; justify-content: space-around; align-items: flex-start;"> <div style="text-align: center;">  <p>Smear _____ Stain _____</p> </div> <div style="text-align: center;">  <p>Smear _____ Stain _____</p> </div> </div>

Signature of the tutor _____

Additional and self-testing materials

Write down the classes of immunoglobulins which are synthesized in sensitization stage of ITH of different types

ITH types	Ig classes
I	
II	
III	

1. Markers and receptors of T-lymphocytes.

Main T-cells markers:

CD2 – the receptor to sheep erythrocytes (human ligand to CD2 is CD58 adhesion molecule)

CD3 – TCR co-receptor

Molecules involved in antigen recognition:

T-cell receptor (TCR): heterodimer composed of two chains. They both are transmembrane proteins of immunoglobulin superfamily. Extracellular part includes variable and constant domains. Together with another chain they form an epitope (antigen specific structure) which is responsible for antigen binding and recognition. Membrane parts stabilize the TCR structure and both membrane and intracellular parts transduce the activation signal to the nucleus.

At present two TCR variants are studied:

■ About 95% T-cells have TCR of the second type, composed of α - β chains. These cells perform all known T-cells functions and circulate through the tissues and blood.

■ The rest 5% T-cells have the first type of TCR (γ - δ). These cells are first in ontogenesis, readily found in the skin and mucosa. Their special functions are not discovered. Like other T-cells they produced wide spectrum of cytokines, can be cytotoxic and respond well to intracellular antigens.

Co-receptors:

TCR associated with **CD3 and CD4 or CD8 molecules**. CD3 is a heteropolymer composed of five polypeptides (γ , δ , ϵ , ζ) which locate in membrane as the whole cluster, are recognized by monoclonal immunoglobulins as CD3, and involved in transduction of signal about binding and recognition of an antigen.

CD4 or CD8 is closely connected to TCR and recognizes the MHC molecules of the second and first types respectively. These co-receptors ensure the restriction of T-cells recognition, because antigens, associated with type II MHC molecules are the product of extracellular antigen processing (i.e. bacteria) and antigens, associated with type I MHC molecules are the product of intracellular antigen processing (viruses).

Adhesion molecules ensure contact interactions of cells and can amplify the main signal from TCR. Important molecules are: CD2 (LFA2) – CD58 (LFA3); CD11a+CD18 (LFA1) – CD54 (ICAM-1); CD49+CD29 (VLA4) - CD106 (VCAM); CD43 - CD54 (ICAM-1). Impaired contact interactions lead to immunodeficiency.

Co-stimulatory molecules are necessary for the development of both humoral and cellular immune response: they amplify the signal about antigen recognition and postpone the activation-induced apoptosis. Important costimulatory molecules are: CD2 - LFA3; LFA-1 - ICAM-1; CD40 - CD40; CD5 - CD72; CD24 - CD24; CD28 - B7.1 (CD80); CD28 - B7.2 (CD86); CTLA-4 - B7.1 (CD80); CTLA-4 - B7.2 (CD86). Impaired costimulatory interactions lead to T (B) cells anergy (afunctional state) and apoptosis.

Costimulatory interactions can be positive or negative and may attenuate the immune response intensity. For example **CD28** and **CTLA-4** on T-cells react with CD80/86 on APC. CTLA-4 – is a receptor with high affinity and negative function. In condition of weak immune process (no inflammation, unprofessional APC, low expression of CD80/86) it is activated first and suppresses an immune response. In the case of high CD80/86 expression usually CD28 low affinity receptors are activated and ensure the development of normal immune response. When activated, T cells increase the CTLA4 expression on their surface and this limits an immune response.

Activation markers:

CD69 – early activation marker (function unknown)

CD25 – alpha chain of IL2 receptor

CD71 – transferrin receptor

CD95 – receptor for activation-induced apoptosis

HLA-II - type II MHC molecules

Molecules for distant interactions

CD25/122/132 – alpha, beta and gamma chains of IL2 receptor

CD121 – IL1 receptor

CD117 – stem cells growth factor receptor

CD124/132 – IL4 receptor

CD127/132 – IL7 receptor

CD129/132 – IL9 receptor

Chemokines and their receptors are very important molecules which determine kinesis and recirculation of immune cells, but there is not enough place here.

2. T-cells with negative regulatory function

T-helpers of the 3rd type (Th3) – CD4+CD3+ T cells, were discovered in 1994. Th3 are found in lymphoid tissues associated with gastro-intestinal tract; produce large amount of IL4 and IL10

T-regulators 1 and 2 were discovered in 1997. These cells are found in immune tissues associated with lungs; produced much IL10.

CD4+CD25+ T-cells were described in 1995. These cells are considered the main effectors of peripheral tolerance. Can suppress other T-cells through contact (CTLA4) or distant (TGFbeta) interactions.

Natural killers with TCR (NKT)-their role as active regulator of cellular immune response was found in 1998. These cells have invariant TCR and NK markers; can produced much IL4 or IF gamma and thus regulate the direction and strength of the immune response.

3. The scheme of the cellular immune response development (primary)

Location	Stages	
	I. Induction of CD4+ T-effectors	
Tissues	1. Antigen (proteins or protein conjugates) is captured by APC, processed and transported to regional lymphatic nodes. 2. APCs process antigen through endosome pathway and present it to CD4+ naïve T-cells .	
Secondary lymphoid organs		
	3. T cells become activated, proliferate and differentiate into CD4+ effectors (Th1, Th2, Th3, Tr1, Tr2, CD4+CD25+ etc.): a) T-cell and APC adhere each other (LFA1+ICAM1 etc.); b) Antigen recognition occurs (TCR+ MHC II-Ag); c) Costimulation occurs (CD28 + CD80, 86); d) T cells begin to express CD25 and thus form complete IL2 receptor, produce IL2, accept it and proliferation starts;	e) Th0 cells differentiate into Th1 under the influence of IL12 produced by APC. IFN gamma can amplify this process; differentiation into Th2 occurs spontaneously. IL4 stimulate this process; Th3 appear under the influence of large doses of IL10 and/or TGF beta; e) mature T-effectors enter recirculation. Usually they die from apoptosis within several weeks; some of them become memory cells.
Blood, tissues, secondary lymphoid organs	4. Mature T-effectors: a) can be activated by interaction with unprofessional APC; b) are able to produce cytokines of different profile; c) are able to recirculate in certain tissues in normal conditions (skin, mucosa of respiratory, gastro-intestinal, genital tracts, body cavities etc.);	d) are able to enter any tissues under inflammation; e) die within weeks from apoptosis without activation; f) can postpone apoptosis for some time when activated.
	5. CD4+ T-effectors differ and therefore can be distinguished by: a) address molecules for migration in certain tissue; b) cytokine profile produced;	c) chemokine receptors pattern; d) effector surface molecules pattern.

<p>6. CD4+ T-effectors function as:</p> <p>a) T-helpers: help B-cells to produced immunoglobulins: activate and make growth factors for B-cells (IL6, IL2); cause the immunoglobulin isotype changing, differentiation in plasmacytes) help naïve CD8+ T-killer precursors: activate and make growth factors (IL2), control differentiation.</p>	<p>b) T-effectors of DTH: they produce cytokines (proinflammatory cytokines, chemokines, anti-inflammatory cytokines, growth factors for broad types of cells (fibroblasts, nerve cells, endothelium etc.));</p> <p>c) T-regulators: they can produce inhibitory cytokines (IL10, TGF beta) or express surface inhibitory factors (CTLA4);</p> <p>d) T-killers (insignificant part of CD4+ cells): CD4+ cells induce apoptosis of target cells in herpes infection.</p>
--	---

II. Induction of CD8+ T-cell (T-killers)

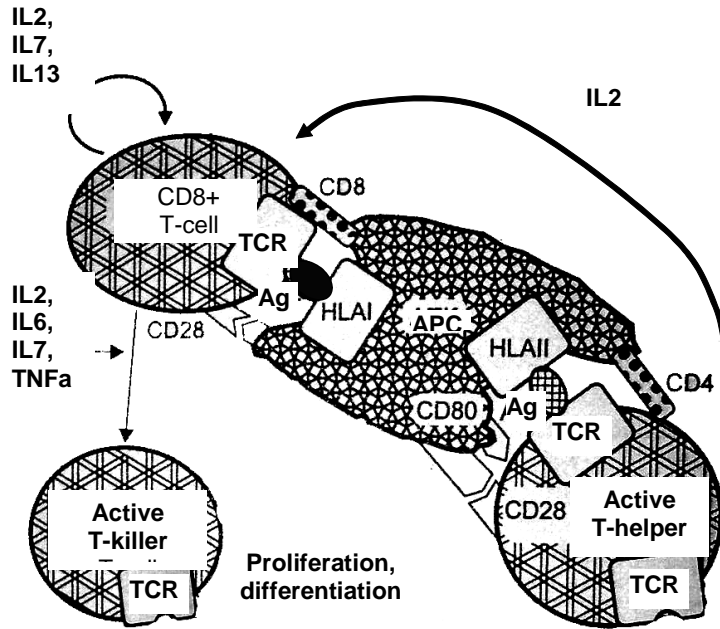
<p>Tissues, secondary lymphoid organs, blood</p>	<p>1. Induction of CD4+ T-effectors (see above).</p>	
	<p>2. APCs capture the antigen and transport it into secondary lymphoid organs: one should take into account that for T-killers the antigen must be processed and presented by cytoplasmic pathway. Therefore: a) APC capture antigen by endosome pathway and somehow transfer it into cytoplasmic one (so-called cross presentation); b) other considerations are even more doubtful.</p>	
	<p>3. APCs present antigen to CD8+ naïve T-cells by cytoplasmic pathway: a) naïve T-killer precursors are considered not able to kill APC during primary activation.</p>	
<p>4. CD8+ cells proliferate, differentiate, enter bloodstream and recirculate (see p. 4 above):</p>	<p>a) CD8+ cells need IL2 from CD4+ T-effectors; b) the requirement for simultaneous activation of CD4+ and CD8+ lymphocytes testifies for triple component model (APC+Th1+Tk) and cross presentation.</p>	
	<p>5. CD8+ T-effectors perform the next functions:</p> <p>a) killing. Activated mature T-killers have no need in additional signals and immediately lyse target cell after recognition of the antigen on its surface. Activated T-killer is able to lyse several target cells. Within few weeks T-killer dies from apoptosis. Some cells can return to the quiescent state and become the memory cells;</p> <p>б) cytokine production (less potent than CD4+ T-effectors). CD8+ cytokine producers can be distinguished in type I and II (like Th1 and Th2);</p> <p>в) immune response regulation (killing of APCs, production of pro or anti-inflammatory cytokines).</p>	

4. Selected methods for allergic diseases diagnostics:

1. Common considerations

1. Skin testing should be performed only in remission.
2. Any kind of skin test may cause severe systemic (anaphylaxis) or local reaction.
3. Skin test should be performed specially trained medical nurse; medical doctor should be present at procedure and register the results.
5. Before skin testing patient should stop antihistamine treatment (usually 48 hours before the procedure).

2. Prick-test

Allergens, positive and negative controls are introduced into epidermis by special disposable lancets. Testing usually performed on the palmary surface of the forearm. The skin is washed by ethanol, lancet or special multilancet device (fig. 13) are dipped into allergen solutions and press against skin tightly. The registration of the results is performed in 20 min by measuring of hyperemia area.

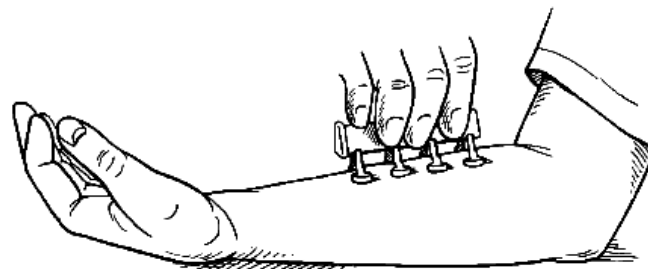

Figure 13. Prick testing (positive and negative control and 6 antigens)

3. Criteria for prick test interpretation

Interpretation		Reaction description
Negative	-	Like negative control
Low positive	+	Urtica 3-5 mm with hyperemia up to 10 mm
Positive	++	Urtica 5-10 mm, with hyperemia up to 10 mm
Highly positive	+++	Urtica 10-15 mm, with hyperemia above 10 mm
	++++	Urtica above 15 mm with pseudopodia, hyperemia above 20 mm
Doubtful	±	Only hyperemia

4. Advantages of prick tests:

1. Easy to perform
2. Arbitrary safe
3. Painless
4. Not expensive

Disadvantages: low sensitivity (10-100 times less sensitive than traditional skin test).

5. Mistakes in allergy diagnostics by skin tests:

A. False negative results:

- 1) absence of the target allergen in panel;
- 2) improper allergen storing;
- 3) improper testing technique;
- 4) diminished skin reactivity because of age, individuality etc.;
- 5) temporary desensibilization after systemic allergic reactions (reflects internalization of IgE by mast cells and decrease of its expression on the surface. Usually skin tests should not be performed up to 3-4 weeks after anaphylaxis;
- 6) influence of anti-allergic drugs.

B. False positive results:

- 1) improper testing technique and/or allergen storing;
- 2) using drugs or food which can liberate histamine;
- 3) pronounced dermographism.

C. Testing results should be correlated with clinic examination data.

Selected laboratory tests for allergy diagnostics

1. methods for the detection of total IgE immunoglobulins in serum

ELISA – the solid phase method in which surface-bound antibody traps a protein (IgE) by binding to one of its epitopes. An enzyme linked antibody specific for a different epitope on the protein surface is employed to detect the trapped protein. The concentration of the target protein can be calculated by standard curve.

2. methods for the detection of specific IgE immunoglobulins in serum

RAST (radioallergosorbent test) - the solid phase method involves binding of the allergen–antigen complex to an insoluble support such as dextran particles or Sepharose®. The serum is then passed over the allergen support complex that permits specific IgE antibodies in the serum to bind with the allergen. After washing to remove nonreactive protein, radiolabeled anti-human IgE antibody is then placed in contact with the insoluble support, where it reacts with the bound IgE antibody. Both the allergen and anti-IgE antibody must be present in excess for the test to be accurate. The amount of radioactivity on the beads is proportional to the quantity of serum antibody that is allergen-specific.

3. *At present an immuno chemiluminescent analysis is also used.*

4. *IgE is measured in WHO U/ml or ng/ml. 1U/ml = 2,4 ng/ml.*

IgE concentration in serum		Semiquantitative estimation of specific IgE		
Age group	KU/ml	Rank	Interpretation	IgE level
New-born	0–2	0	Negative	Not determined
3–6 months	3–10	1		Low
1 year	8–20	2	Uncertain	Average
5 years	10–50	3		High
10 years	15–60	4	Positive	Very high
Adults	20–100	5		Very high

Class 5. Cellular immune response. Allergy

Selected methods for the cellular immunity study

1. Cells isolation methods for blood are described above.

2. Morphological study of T-cells usually is conducted by flow cytometry against CD antigens (described above). This method allows to determine the subpopulation composition of blood lymphocytes, to study the activation status of T-cells, apoptosis, intra and extracellular cytokines production and other molecules important for cell function. Modern cytometric methods may give valuable information about T-cell specificity (tetramer assay), proliferation, thymus function (T-cells diversity) and so on.

There are also many other techniques for T-cell study that have limited application or are of historic importance.

3. Functional in vitro study includes stimulation tests: T cells (usually peripheral blood mononuclear cells) are stimulated by mitogen, antigen or monoclonal antibodies to CD3 and CD28 and the results (the range of activation, proliferation, cytokines production)

cytotoxicity, apoptosis etc.) are measured by variety of methods: from cells count (percent of blasts) to flow cytometry, ELISA and RT-PCR.

4. Functional in vivo study includes intraskin testing, cytokines and other bioactive T-cells products determination in blood and tissues.

Isolation of T cells for in vitro assays

Most of the assays of T-cell function described below are carried out using peripheral blood mononuclear cells (PBMCs), which are obtained from venous blood by differential density centrifugation. In many situations, this level of cell separation is sufficient; however, if pure populations of T cells or a particular T-cell

subset are required, then additional methods can be used. These include sorting individual cells (or populations of cells) into microtitre wells using flow cytometry (cell sorting), or the use of magnetic beads coupled to monoclonal antibodies to enrich or deplete subsets of cells in a population of cells (based on cell-surface markers).

Lymphoproliferation assays using ^3H -Thy

The measurement of the proliferation of lymphocytes that occurs following various stimuli (such as exposure to mitogenic agents, polyclonal stimuli or specific antigens) is a fundamental technique for assaying T-cell responses. However, simple enumeration of T cells before and after such stimulation is laborious, and in most cases is not possible because the cells that are responding represent only a small percentage of the total cell population at the start of the assay. This is certainly the case when assaying antigen-specific responses. Therefore, the incorporation of radiolabelled tritiated thymidine (^3H -Thy) into the DNA of dividing cells is commonly measured. This assay requires cells (usually PBMCs) to be incubated in the presence of the antigenic or mitogenic stimulus for 3–7 days, before the addition of ^3H -Thy for 6–18 hours. The total amount of the radiolabel that was incorporated into the cells in that time period is then measured, which provides a measure of the rate of synthesis of DNA by the entire population of cells. In a ‘standard’ assay, the cells are co-cultured with a range of concentrations of stimulating antigen, and at least one other antigen to act as a control to determine the specificity of the response. Results are usually expressed as a stimulation index (SI), which is the ratio of the scintillation counts (as a result of the incorporated ^3H -Thy) obtained in the presence of the test antigen, divided by the counts obtained in the presence of the control antigen (or culture medium alone).

Incorporation of ^3H -Thy provides a good correlate of T-cell division, although it does not necessarily reflect the overall size of the final cell population because some stimuli can induce rapid division and yet be toxic in the longer term to many of the cells exposed to them. Furthermore, no information about the synthesis of DNA by individual cells is obtained.

Analysis of the expression of activation markers on the surface of T cells by flow cytometry has also been investigated as a method for evaluating T-cell proliferation. Cell-surface markers (molecules) that have been used include: CD25, CD69, CD71 and HLA-DR (a subtype of human MHC class II molecule), all of which are upregulated following T-cell activation. This approach has the advantage that the expression of other cell-surface molecules can be analysed simultaneously, allowing further characterisation of the responding-cell population. However, the correlation between the percentage of T cells that stain positively for the markers listed above and the incorporation of ^3H -Thy is not always good, suggesting that the two techniques might be used to complement one another, rather than be considered as alternatives.

Although lymphoproliferation assays require several days of cell culture, they are reasonably straightforward and can be used to analyse relatively large numbers of samples. The degree of proliferation observed is proportional to the number of antigen-specific cells that are present in the original population. However, in its simplest form described above, the assay might not always be sufficiently sensitive or quantitative to compare the relative numbers of antigen-specific lymphocytes in a series of PBMC samples, such as might be drawn over a period of time to follow the effect of vaccination, or the response to an infection.

Limiting-dilution analysis

To provide quantitative estimates of the number or frequency of T cells present in a given PBMC population that are specific for a particular antigen, limiting-dilution assays (LDAs) are required. These assays provide an estimate of the ‘precursor frequency’ of a given cell type. Positive results in this assay (proliferation or cytotoxicity, see below), indicate the presence of antigen-specific precursor cells in the PBMC population at the start, which have become activated and have subsequently divided during the period of cell culture. The function of these cells is then measured in the assay by either proliferation, cytokine production or cytotoxicity.

In LDAs, many micro-lymphoproliferation assays are prepared in vitro, using a range of dilutions of the cell population under investigation, with at least 24 replicate cultures at each dilution. Other factors (such as growth factors, antigen and APCs) need to be added to the microtitre wells in excess, so that the only parameter that is limiting is the number of responding antigen-specific cells that are present in the cell population at the start. Under these conditions, and assuming that 'single-hit' kinetics apply, the number of non-responding cultures follows the Poisson distribution. A semi-log plot of the percentage of non-responding cultures plotted against the number of input cells per culture should produce a straight line, and the input number of cells at the start that contained on average one specific precursor cell can be calculated from the zero term of the Poisson distribution. Several different statistical approaches for calculating the precursor-cell frequency have been described, including minimum χ^2 and maximum likelihood analysis. Detailed comparisons of these and other methods have already been published.

A variation on the lymphoproliferation LDA, which can be used to assay helper T-cell frequencies, is one that measures cytokine production from each micro-culture. Supernatant is harvested from the stimulated cultures, and assayed for the presence of cytokine, either by enzyme-linked immunosorbent assay (ELISA) or by bioassay. This assay has the advantage that it can be faster than assessing cell division by the incorporation of ^3H -Thy. This approach has been used to enumerate the frequency of T cells that are specific for the antigen tetanus toxoid, and the infectious agents human cytomegalovirus (HCMV) and herpes simplex virus. LDAs provide more information than the standard lymphoproliferation assay, but also require significantly larger quantities of PBMCs (at least 50 ml of blood is often required for each assay). Furthermore, the assay is critically dependent on a clear distinction being made between 'positive' and 'negative' cultures. This usually involves defining a threshold, typically two or three standard deviations above the mean value of the background proliferative response. However, in practice, the background counts are not always evenly distributed about the mean, with the right-hand 'tail' being considerably longer than the left-hand 'tail'. In such situations, reliance on a threshold can be problematic, with minor differences in the definition of the threshold leading to very different estimates of the frequency of precursor cells.

Broman and co-workers have developed an alternative assay to address these drawbacks. Their method is more sensitive than the standard proliferation assay, and it might provide a more efficient alternative to the standard LDA. In this assay, the population of cells at the start are diluted into microtitre wells at a single (carefully chosen) cell density, rather than being used at a series of dilutions; at the end of the incubation period, the amount of thymidine incorporated in each well is used to estimate the absolute number of responding cells per well, rather than using an arbitrarily defined threshold to estimate which wells have cells that responded. This assay has been used successfully to monitor frequencies of antigen-specific T cells in individuals who had been immunized with a sub-unit vaccine consisting of glycoproteins B and D of HSV-2.

In summary, proliferation assays can be a very useful tool for monitoring immune responses; they are relatively easy to perform, and can be used to process relatively large numbers of samples. The further development of (often cumbersome) LDAs means that quantitative information on cell frequencies can now be obtained on a larger scale than before; however, one drawback of proliferation assays is that they do not provide a measure of the effector function of the responding cells. Indeed, it is not entirely clear which T-cell function or subset of T cells is being measured in lymphoproliferative assays, and so these assays are used solely to provide a general indicator of T-cell reactivity.

Measurement of cytokine production by T cells

Assessing cytokine production using immunoassay or bioassay

As described above, helper T cells can be subdivided into Th1 and Th2 populations, based on the types of cytokines that are produced following antigen-induced activation. It can be invaluable to know the relative proportions of these two populations of cells that are circulating in vivo following immunization, or during an attempt to use an immunotherapeutic agent to modify a disease process. In some cases, a Th1-dominated response can be beneficial, whereas a Th2-dominated response might be ineffective, or even detrimental. Cytokine levels in body fluids can be measured directly; alternatively (as discussed here), populations

of T cells can be stimulated and cultured *in vitro*, and the quantities of cytokines that are produced can be determined. In either situation, both bioassays and immunoassays can be used. Immunoassays are often favoured because they can be faster and, unlike bioassays that involve tissue culture, do not require the use of as many items of specialized equipment. These bioassays have the advantage that they measure the biological effects of cytokines, and so only functional cytokines are measured. However, cytokines that are bound to soluble cytokine receptors (which can be present in plasma or serum) will not be detected. Another disadvantage of bioassays is that of lack of specificity; all of the reporter cell lines that are used in these assays will respond (and can give a similar response) to at least one cytokine, and several cytokines can be present in the culture supernatant during the assay. This problem can be largely overcome by the incorporation in the assay of monoclonal antibodies to bind to (and inactivate) the ‘cross-reactive’ cytokines. A comprehensive review of cell lines and bioassays available has been published by Mire-Sluis et al..

The simplest means to estimate Th1 and Th2 T-cell responses at the level of the total cell population is to culture PBMCs or T cells *in vitro* in the presence of the appropriate antigen or stimulus. After a specified period of time, the supernatant from these cultures is removed for testing and assayed for the presence of cytokines that are indicative of the Th1 and Th2 subsets [e.g. interleukin 2 (IL-2) and interleukin 4 (IL-4), respectively] using an ELISA or bioassay.

Assaying cytokine production at the level of the total cell population has the advantage that the cytokines are produced in measurable amounts. However, the amount of cytokine measured might not accurately reflect the total quantity of cytokine produced, because some of the cytokine might have bound to, and been ‘used up’ by, cells that are present in the culture. One solution to this problem is to measure cytokine messenger RNA (mRNA) levels, which can be done quantitatively using competitive polymerase chain reaction (PCR) assays. However, this then relies on the (not always valid) assumption of a direct relationship between the amount of mRNA that encodes cytokines and the amount of cytokine protein secreted.

More information can be gained if cytokine production is assayed at the level of the individual cell. As with proliferation assays, LDAs allow the frequency of cytokine-producing precursor cells to be determined, but again the assays are unwieldy and time-consuming.

Cytokine measurement by ELISPOT assays

The enzyme-linked immunospot (ELISPOT) assay is an adaptation of the ELISA, which measures the local concentration of cytokines that are released from an activated T cell. In the ELISPOT method, cells that have been stimulated with antigen *in vitro* were incubated in nitrocellulose-lined microtitre wells, which have been pre-coated with anti-cytokine antibody. After incubation (for several hours or days), the local production of cytokines around ‘producing cells’ can be visualized by adding a second antibody that is labeled with the enzyme alkaline phosphatase or horseradish peroxidase, and then adding a substrate that is enzymatically converted into an insoluble colored product. Cytokine-producing cells can then be visualized as ‘spots’. This assay is up to 200 times more sensitive than conventional ELISAs, is non-radioactive, and provides quantitative data as accurately as can conventional LDAs.

The major disadvantage of the ELISPOT method is that scoring the wells for positive reactions involves the manual enumeration of large numbers of colored spots, which can vary greatly in size and shape; thus, this method is subject to operator bias. Despite this drawback, ELISPOT assays have been used extensively and successfully to characterize cytokine profiles and define responding subsets of THLs in several human diseases. Computer-based image-analysis systems are now being developed to increase the accuracy and speed of scoring ELISPOT assays.

Intracellular-cytokine staining

Cytokine production at the level of the single T cell can be analyzed using flow cytometry to detect pools of intracellular cytokines. T cells are stimulated *in vitro* [typically with phorbolmyristate acetate (PMA) and ionomycin], and for at least some of the stimulation period monensin or brefeldin A are present to block the transport of cytokines through the Golgi apparatus, and therefore prevent the secretion of cytokines. The T cells are then fixed, permeabilized (to allow cytokine-specific antibodies to enter the cell), and stained for the presence of intracellular cytokines using directly conjugated anti-cytokine antibodies.

Intracellular-cytokine staining offers several advantages to the researcher: large numbers of T cells can be analyzed in a short period of time; also, the use of multiple antibodies that are coupled to different fluorochromes allows the co-production of more than one cytokine to be analyzed, and/or the determination of the phenotype of the cells that are producing the cytokine. This method has been used successfully to characterize cytokine production by circulating CD4⁺ T cells in the peripheral blood of individuals who are infected with human immunodeficiency virus.

Measurement of T-cell cytotoxicity

CTLs are believed to play critical roles in the control of many viral infections, and also in the destruction of tumour cells. For this reason, there has for many years been much interest in developing assays to detect the presence of CTLs. Classically, CD8⁺ T cells have been regarded as the T-cell population that mediates cytotoxic activity. This view is consistent with the ability of CD8⁺ T cells to recognise antigens that are processed via the endogenous pathway, which would be the pathway for the presentation of peptides that are derived from viral proteins synthesized within a virally infected cell. However, cytotoxic activity is not the exclusive preserve of CD8⁺ T cells. For example, CD4⁺ T cells have been reported to be responsible for cytotoxic activity in several human diseases and animal models of disease; moreover, CD4⁺ CTLs are believed to be a significant, if not the dominant, cytotoxic population of cells in some virus infections such as HSV-2.

Chromium-release assay

For many years, the standard assay for cytotoxic function has been the chromium-release assay. First described by Brunner and co-workers, the assay involves the radiolabeling of 'target cells' with sodium chromate (Na₂⁵¹CrO₄). The radiolabelled target cells are then incubated with the test effector-cell population for a short period (4–6 hours). The amount of ⁵¹Cr released into the supernatant is then quantified, to provide a measure of target-cell lysis. ⁵¹Cr in the form of Na₂⁵¹CrO₄ offers the advantage of being taken up by live cells in its hexavalent form, but is released from lysed cells in its trivalent form, which is not re-utilized.

It has been estimated that each CTL effector cell is capable of lysing up to five target cells in the same microtitre well, during the course of a 4-hour assay. To achieve lysis of 50% of the target cells (of which there are usually 2000–5000 in each microtitre well), therefore, requires 200–500 CTLs. The effector-cell population is tested at a range of concentrations, up to 100 times the number of target cells (e.g. 5000 x 100 effector cells per well). Therefore, the CTLs must be present at a frequency greater than, or equal to, approximately one per thousand in the effector-cell population at the start of the assay in order to be detected, because of limitations in the total number of effector cells that can be placed in the microtitre well.

In the vast majority of cases, the activated CTLs that are under investigation are present in the peripheral blood at too low a frequency to be detected simply by using freshly isolated PBMCs as effector cells in the ⁵¹Cr-release assay. Exceptions to this rule include the measurement of specific CTLs in measles cytomegalovirus, mumps and HIV⁺ subjects before the onset of acquired immunodeficiency syndrome (AIDS); in some such individuals, the CTLs can be detected directly. Most other situations require the CTLs to be re-stimulated and expanded in number in vitro, typically for 10–14 days before carrying out the assay. Technically, this can be problematic because in many cases it requires both a source of antigen and a source of autologous APCs to present the antigen. Furthermore, the manner in which the antigen is provided can profoundly affect the nature of the responding T cells that will be detected in the assay. For example, the provision of soluble or particulate antigen in the culture will lead to the preferential expansion of CD4⁺ CTLs. To generate CD8⁺ CTLs, antigens need to be processed via the endogenous pathway. This requires the antigen to be provided in the form of infected autologous cells (for example those that are infected by either the pathogen under study or a recombinant virus that expresses the target protein). Alternatively, synthetic peptides that represent a previously identified and characterized CTL epitope can be used; this is because such peptides can bind directly to MHC class I molecules at the cell surface of the APCs.

The influence of the nature of the antigen that is presented during the in vitro re-stimulation process has been demonstrated in several cases. For example, LDAs of HSV-specific CTLs showed that either CD4⁺ T cells or CD8⁺ T cells predominated, depending on whether inactivated virus or virus-infected stimulator

cells, respectively, were used. Similarly, re-stimulation with inactivated whole influenza virus lead to the generation of CD4⁺ CTL lines, whereas cells infected with (live) influenza virus stimulated predominantly CD8⁺ CTL lines.

Finally, after the re-stimulation phase, an additional source of autologous (or HLA-matched) APC and antigen are often required for use as target cells in ⁵¹Cr-release assays. Thus, while such assays are proving to be a useful research tool, they are not suitable for screening large numbers of samples, because they can require up to three weeks of in vitro culture, up to two different autologous cell lines, and at least one source of antigen. Despite these shortcomings, CTL assays of this type have been used successfully to monitor phase I clinical trials of several vaccines.

The data obtained from ⁵¹Cr-release assays that use cells from such short-term 'bulk' T-cell cultures as effector cells are only semi-quantitative. The specific lysis of the target cells can reflect the relative proportions of specific precursors in the starting population, but the assay does not allow estimates of frequency of CTLs to be made. ⁵¹Cr-release assays have been successfully adapted to the LDA format, although these assays are large and somewhat unwieldy, and require at least 50–100 ml of peripheral blood per assay. Some of these disadvantages can be overcome by automating some of the operations such as setting up the original cultures or the ⁵¹Cr-release assay. Once established though, LDAs of CTLs can be very powerful; furthermore, if the appropriate target cells are available, they also enable the relative frequencies of CTLs with different antigen specificities to be analyzed. This has been achieved with several virus infection systems, including HCMV. However, although the data are quantitative, it must be remembered that what is measured is the number of cytotoxic T lymphocyte precursor cells (CTLp) that are able to divide a sufficient number of times during the period of culture, and then carry out specific lysis of the target cells. CTLs that have the appropriate antigen specificity but are at a different stage of differentiation might not be detected using this method.

Alternative cytotoxicity assays that avoid the use of ⁵¹Cr

Methods that are able to measure cell lysis but do not require the use of (radioactive) ⁵¹Cr have been of interest for some time, and include colorimetric assays, which are available as kits from some manufacturers. More recently, assays that use the technology of time-resolved fluorometry have been developed. In this case, target cells are labelled by forming a complex with europium diethylenetriaminopenta acetate (Eu³⁺ DTPA). After the release of the Eu³⁺-complex from lysed cells, a highly fluorescent complex is formed in an enhancer solution. After laser excitation, the fluorescence decay of the complex is relatively long (100–1000 ns), and can be distinguished from background fluorescence by time-resolved fluorometry. This assay has been used successfully in place of the standard ⁵¹Cr-release assays by some groups. However, there appears to be more variability in the ability of different target-cell types to be labeled and to retain the label with ³⁺Eu, than with ⁵¹Cr, and for some users who have a wide range of target-cell types, this might limit its utility.

Matzinger and co-workers have developed the JAM assay, which is based on events that occur during cell death by apoptosis. In this assay, the target cells should, ideally, be a rapidly dividing cell type. The target cells are labeled for up to 18 hours with ³H-Thy, which is incorporated into the DNA, before the target cells are co-cultured with the effector T cells. Apoptosis, which is induced by CTL-mediated killing during the assay, induces laddering of DNA in the target cells. The entire contents of the microtitre well (T cells and target cells) are then harvested onto glass-fibre filters, as in lymphoproliferation assays; intact DNA (with its associated radiolabel) is trapped on the filter, whereas fragmented (laddered) DNA passes through into the waste. Thus, an 'absence of (scintillation) counts' indicates cytotoxic activity in the effector T-cell sample.

ELISPOT assays for CD8⁺ T-cell activity

Assays that measure cytokine production by activated CD8⁺ T cells can be used as an alternative means of investigating CD8⁺ T-cell activity. In particular, ELISPOT assays to detect interferon γ (IFN- γ) and tumor necrosis factor α (TNF- α) have been developed as alternatives to the ⁵¹Cr-release assays as a measure of CD8⁺ T-cell activity. The method for detecting CD8⁺ T cells using the ELISPOT assay is essentially the same as that described above, but in this case, the antigen that is used is typically a short synthetic peptide, representing an epitope that is known to be recognized by CD8⁺ CTLs. As before, the ELISPOT method can be

used to provide a quantitative measure of CD8⁺ T cells that produce IFN- γ and/or TNF- α . Studies of human CTLs that are specific for influenza virus, using ELISPOT and conventional ⁵¹Cr-release assays, suggest a good correlation between the two methods. However, the ELISPOT assay might be more sensitive than ⁵¹Cr-release assays for studying populations of T cells that are present at low frequencies.

Tetramer analysis for direct 'visualisation' of CD8⁺ T cells

Recent technological advances have now made possible one of the long-term goals of T-cell assays, namely to identify individual T cells on the basis of the specificity of binding to the MHC-peptide complex. This had not been possible previously, owing to the complex nature of recognition of antigens by T cells, which requires the interaction of the TCR, the antigenic peptide, and both the heavy and the light chains of MHC class I molecules. Furthermore, the interaction of this complex is low affinity, with a fast 'off-rate' (the TCR dissociates rapidly from the MHC-peptide complex). Several groups have now shown that it is possible to generate tetrameric forms of MHC-peptide complexes, which are able to interact specifically with T cells that bear TCRs with a corresponding specificity.

In the tetramer-analysis method, the restricting MHC molecule is synthesized in a soluble form by **Escherichia coli**. At the carboxyl (COOH) terminus of the molecule, a sequence that can be recognized by the enzyme BirA is incorporated. At this stage, the MHC molecule is not correctly folded for peptide binding but the correct conformation can be induced by the addition of light chain (β_2m) and the peptide that represents the appropriate peptide epitope. The enzyme BirA is then used to attach the polypeptide biotin to the biotin-recognition sequence. The complex (via biotin) can then be attached to another polypeptide streptavidin, which has previously been tagged with a fluorochrome. Because each streptavidin molecule has four biotin-binding sites, a tetrameric complex is produced, which contains four MHC class I molecules; this complex has a greater affinity for T cells than monomeric MHC class I molecules. The presence of the fluorochrome allows T cells that have bound the tetramer to be detected by flow cytometry.









The tetramer-analysis method has already been used to study CD8⁺ T-cell responses in mouse models of acute virus infection, such as lymphocytic choriomeningitis virus (LCMV), as well as in virus infections of humans, such as Epstein-Barr virus (EBV) and HIV. Interestingly in these cases, tetramer analysis has revealed that the expansion of antigen-specific CD8⁺ T cells during the acute phase of the response is far greater than previously thought. The large numbers of CD8⁺ T cells do not appear to be due to a 'bystander effect' (proliferation of T cells that are not antigen-specific but are driven by local cytokine production).

One of the main limitations of the tetramer-analysis method is that it is applicable only in situations where the CD8⁺ T cells that are being quantified recognize a well-defined peptide epitope in conjunction with a known MHC class I molecule. Therefore, at present, it can be applied only to the analysis of a relatively small number of T-cell responses. However, tetramer analysis offers many potential advantages over some of the more 'traditional' CTL assays. This method is quantitative, it does not require the use of radioisotopes, and it is fast, so that fresh blood (or tissue-derived) samples can be analyzed, and large numbers of samples can be processed. Because the analysis is performed using a flow cytometer, cells can be stained with the tetramer and at the same time with fluorescently labeled monoclonal antibodies that are specific for other cell-surface molecules; this allows additional characterization of the responding cells. However, unlike the intracellular-cytokine staining method (described above), tetramer staining does not kill the labeled cells; therefore, the cells can be cell sorted into homogenous cell populations by flow cytometry, and placed into additional assays (such as the ELISPOT assay) to confirm their functional ability. Finally, unlike LDAs, specific T cells can be analyzed from blood samples without the prerequisite of in vitro culture; some populations of CTLs that have been expanded in vivo might have limited growth potential in vitro, and therefore might not be detected by LDAs. Instead, the LDAs might detect only a sub-population of CTLp that are able to grow preferentially in vitro.

Practical class № 6 (14).

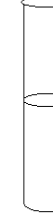
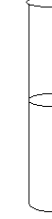
Date _____

The topic: Immunoprophylaxis and immunotherapy. Methods for vaccinal immunity evaluation

<p>Suggested reading for self-study: Immunoprophylaxis and immunotherapy. Vaccines, classification, essential characteristics. Vaccinal immunity, factors affecting its development. Primary and secondary immune response. Buster reaction. Methods of vaccinal immunity evaluation. Passive immunoprophylaxis. Immune sera and serum preparations; methods of its production and application. Clinic immunology: definition. Immune status. Immunogram. Primary and secondary immunodeficiency.</p>		<p>[1]: p.119-142; 172-205.</p>
<p>Laboratory exercises</p>	<p>Laboratory report</p>	
<p>1. Register the AR for the evaluation of immunity to whooping cough.</p>	<div style="display: flex; justify-content: space-around; align-items: flex-start;"> <div style="text-align: center;"> <p>1/50</p>  </div> <div style="text-align: center;"> <p>1/100</p>  </div> <div style="text-align: center;"> <p>1/200</p>  </div> <div style="text-align: center;"> <p>1/400</p>  </div> <div style="text-align: center;"> <p>1/800</p>  </div> <div style="text-align: center;"> <p>SC</p>  </div> <div style="text-align: center;"> <p>AC</p>  </div> </div> <p style="text-align: right;">Conclusion: _____</p>	
<p>2. Perform the passive hemagglutination test for the detection of rheumatoid factor. Diagnosticum = armed bull erythrocytes coated with human IgG. Rheumatoid factor is an autological antibodies (IgM) to IgG. It is found in certain autoimmune diseases (SLE, RA etc.) and is useful for diagnostics.</p>	<div style="display: flex; align-items: flex-start;"> <div style="margin-right: 20px;"> <p>1</p>  </div> <div style="margin-right: 20px;"> <p>2</p>  </div> <div style="margin-right: 20px;"> <p>3</p>  </div> <div style="margin-right: 20px;"> <p>1. Diagnosticum 2. Patient's serum 3. Saline solution</p> </div> </div>  <p style="text-align: right;">Conclusion: _____</p>	

3. Perform the LA test to detect autoantibodies to thyroglobulin

Latex diagnosticum = latex microsphaera coated with thyroglobulin molecules

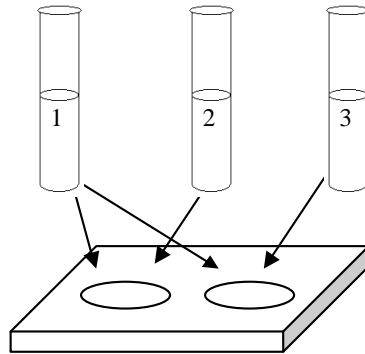

1. Latex diagnosticum
2. Patient's serum
3. Saline solution

Conclusion: _____

4. Register the passive hemagglutination test for the evaluation of immunity to diphtheria.

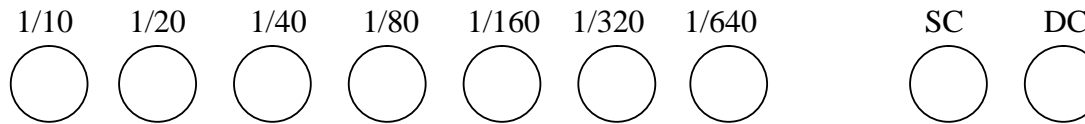

Protective titer = 1:40.

Conclusion: _____

Protective titer – surrogate marker of the organism immunity (due to antibodies formation) to particular infection.

Signature of the tutor _____

Additional and self-testing materials.

The scheme of the passive hemagglutination test for evaluation of vaccinal immunity to diphtheria:

- a) mark the wells according to the table
- b) place saline in the well according to the table
- c) place serum in first, second and eighth wells. Mix liquid in the second well and transfer 0,25 ml to the next tube. Change the tip of a dosator each time. After transfer and mixing of 7th well, take away and dispose 0,25 ml of liquid;
- d) place 0,25 ml of diagnosticum in each tube except serum control tube;
- e) shake briefly and incubate at 37°C for 2 hours;
- f) register the results.

Passive hemagglutination test									
Ingredients	Tube number, dilution							Controls	
	1 (1/10)	2 (1/20)	3 (1/40)	4 (1/80)	5 (1/160)	6 (1/320)	7 (1/640)	SC	DC
Saline		0,25	0,25	0,25	0,25	0,25	0,25		0,25
Serum	0,25	0,25	-	-	-	-	-	0,5	-
Diagnosticum	0,25	0,25	0,25	0,25	0,25	0,25	0,25	-	0,25
Incubation for 2 hours at 37° C									
Results registration									

2. Result registration by “+” system:

- ++++ agglutinated erythrocytes cover the bottom of the well like “an umbrella”, the sediment of erythrocytes in the middle of the bottom is absent;
- +++ good “umbrella” and slight erythrocytes sediment (“button”);
- ++ weak “umbrella” and good sediment;
- + very weak agglutination and pronounced sediment;
- no agglutination, all erythrocytes form dense sediment in the middle of the well bottom (like diagnosticum control).

1. New kinds of vaccine:

Vector vaccine includes two components:

A. Gen of the highly conserved protein of the microbe which can induce the protective immune response;

B. Vector: non pathogenic microorganism, which ensure production and transportation of the target protein in proper organism compartment, its persistence there and proper cellular and cytokine microenvironment formation for the right kind and strength of an immune response development.

Among perspective vectors are:

- Vaccinia virus and all existed live attenuated antivirus vaccines. They ensure proper presentation (by cytoplasmic pathway) and promote T-killer response, allow to use T-helpers created in previous immunization with the vector;
- BCG: its genome is large enough to include big genetic constructs; BCG is a potent cellular immune response stimulator;
- Attenuated *Salmonella* strains (ideal for enteric diseases prophylaxis): they can transport target antigen to the gut lymphoid tissue, stimulate inflammation, antigen presentation (by endosome pathway) and an immune response development.

DNA-vaccine («revolution» in vaccinology) is a DNA fragment (plasmid) which includes genes coding for the target protective proteins. Such DNA can be introduced in myocytes by injection or “Gene gun” or by nasal spray.

DNA vaccine advantages

1. Plasmids are easy to produce in large quantities
2. DNA is very stable
3. It is easy to improve by sequence changing.
4. Target proteins arise inside cells and are naturally presented in cytoplasmic pathway. Besides, they undergo the same posttranslational changes as other proteins in human cells (the problem of recombinant vaccine).
5. Plasmids are easy to combine.
6. Plasmids do not replicate and have no unwanted impurities.
7. They are not immunogenic themselves.
8. These technology may is of importance for prophylaxis of viral infections and diseases caused by intracellular pathogens (tuberculosis).

Possible gaps

1. Integration into host genome and mutation induction
2. Autoimmune reaction to DNA development
3. Immune toleration development to the target antigens.

2. Serotherapy. Antisera and immunoglobulin preparations

Antisera and immunoglobulin preparations are routinely used for:

- Immunodeficiency therapy
- Immune cells depletion (treatment for autoimmune diseases)
- Cancer therapy (immunotoxins)
- Prevention of the alloimmunization of Rhesus-negative (Rh₋) women
- Prevention and treatment of infection.

The ability of antibody to neutralize toxins and organisms is exploited to prevent several infectious diseases. Antibodies used include human hyperimmune globulin, equine serum and humanized MAbs. Indications include exposure to:

◆Tetanus – the causative toxin can be neutralized by antibodies. Human hyperimmune serum is given following a high-risk injury in non-immune patients.

◆Hepatitis B – the risk of infection is reduced by neutralizing antibodies, which inhibit viral entry into cells. Human hyperimmune serum is administered after high-risk exposure in non-immune individuals.

◆Varicella zoster (VZV) – in non-immune, immunocompromised or pregnant patients, primary infection can be fatal. Neutralizing antibodies can reduce the risk of infection as well as the severity. Specific VZV immunoglobulin, or batches of intravenous immunoglobulin known to have high anti-VZV titers may be used post-exposure in high-risk groups.

◆Cytomegalovirus – infection in immunosuppressed patients can cause severe disease. Immunoglobulin treatment was widely used as prophylaxis; however antiviral agents like ganciclovir are now used more commonly.

◆Hepatitis A – immunoglobulin can be used in immunocompromised individuals, following exposure or prior to travel. Vaccination is preferred in immunocompetent individuals.

◆Rabies and botulism – equine antibodies given post exposure may be of value in these life-threatening infections.

◆Respiratory syncytial virus – RSV causes bronchiolitis in young children, and severe illness in children born prematurely, particularly if they have had bronchopulmonary dysplasia. Palivizumab, a humanized neutralizing MAb, can be administered monthly during the RSV season to reduce the risk of infection.

- Immunomodulation

Immunoglobulin preparations can be used for immunomodulation:

Infliximab is a humanized MAb, which inhibits TNF, and etanercept is a TNF receptor grafted onto an IgG molecule. Anti-TNF therapy is used in rheumatoid disease, Crohn’s disease and juvenile arthritis.

Monoclonal antibodies are also used for IgE elimination and allergy treatment

- Neutralization of envenomation

Concluding test: «Immunology. Immunity. Allergy»

<ol style="list-style-type: none"> 1. Immunology. Definition, tasks, methods. History of immunology. 2. Immune system. Characteristics. Organs, cells. 3. Molecules of an immune system: receptors, MHC molecules of I, II and III types, adhesins, immunoglobulins superfamily. 4. Cytokines. Definition, classification. Biological importance, clinical application. Chemokines and its receptors. 5. Immunity: definition, classification. Characteristics of innate and acquired immunity. Anti-infection immunity. 6. Innate immunity: definition, immune and non immune factors, characteristics. 7. Complement system: definition, ways of activation, functions. Medical importance. Methods of complement activity evaluation. 8. Phagocytosis. Phagocytes. Phagocytosis phases. Intracellular killing mechanisms. Phagocytosis outcome (complete, incomplete). Chemotaxins, opsonins: origin and medical importance. 9. Phagocytosis evaluation methods. 10. Immune response and factors influencing its strength. Genetic control of humoral and cellular immune response. 11. Humoral immune response. Primary and secondary immune response. 12. B-lymphocytes, characteristics, main markers. Methods for B-lymphocytes quantity and functional activity evaluation. 13. Antigens: structure, classification, characteristics. 14. Bacteria antigenic structure. Group, species and type antigens. Cross-reacting antigens. Antigenic formula. 15. Antibodies, structure-functional organization of immunoglobulin molecule, characteristics. Antidiotypic antibodies. 16. Classes of immunoglobulins, characteristics. Immunoglobulins Subclasses, allotypes, isotypes, idiotypes. Methods of immunoglobulins concentration determination. 17. Mechanisms of antigens and antibodies interactions. Specificity. Phases. Affinity. Avidity. 18. Serology reactions, characteristics. Serum titer, diagnosticum, diagnostic serum, clinical importance. 19. Agglutination reaction. Methods of conduction and result registration. Medical importance. 20. Passive hemagglutination, ingredients. Methods of conduction and result registration. Medical importance. Reversed passive agglutination test. Latex agglutination. 21. Precipitation reaction. Methods of conduction and result registration. Medical importance. 22. Immunofluorescence test. Medical importance. 23. Immunoenzyme analysis. ELISA. Ingredients, methods of conduction, results registration, characteristics. Medical importance. 24. Immune lysis reactions. Complement fixation test. Ingredients, methods of conduction, results registration, characteristics. Medical importance. 25. Cellular immune response, main phenomena. Immunological memory. 26. Subpopulations of T-lymphocytes (T-helpers, killers, regulators), characteristics. Main markers, TCR. Genetic control of TCR diversity. 	<ol style="list-style-type: none"> 27. T-lymphocyte activation. Costimulation. Two signals model. Anergy. Apoptosis. 28. Methods for T-lymphocytes quantity and functional activity evaluation. 29. Local immunity, main components. Medical importance. 30. Allergy: definition, classification. Allergy phases. 31. Allergens: definition, classification, characteristics. 32. Allergic reaction of immediate type, clinical phenomena. 33. Mediator type of ITH: definition, mechanisms, clinical phenomena, approaches for prophylaxis. 34. Cytotoxic (II) and immunocomplex (III) ITH types: definitions, mechanisms, clinical phenomena. 35. Hypersensitivity of delayed type (IY): definition, classification, clinical phenomena. 36. Methods for ITH diagnostics (in vivo and in vitro). 37. Methods for DTH diagnostics (in vivo and in vitro). 38. Immune tolerance: definition, mechanisms, medical importance. 39. Transplantation immunity. MHC antigens of I, II, III types, role for an immune response development. Transplantological reactions. Mechanisms of transplant rejection. Prophylaxis. 40. Clinical immunology: definition, aims. Ecological immunology, main immunotropic ecological factors. 41. Primary and secondary immunodeficiencies: definitions, classification, medical importance. 42. Immune status: definition, methods for evaluation. Immunogram. Influence of way of life on the immune system function. 43. Autoimmune diseases, classification. Autoantigens. Mechanisms of autoimmunity. Tumor associated immunity. 44. Immunoprophylaxis and immunotherapy of infections. Achievements and problems. 45. Vaccines, main demands. Classification, characteristics, approaches to development. New vaccines. 46. Vaccinal immunity. Factors influencing vaccinal immunity. Methods of evaluation. Collective immunity, methods of evaluation. 47. Passive immunoprophylaxis. Antisera for therapy and prophylaxis, medical importance. 48. Immunocorrection. Methods for suppression and stimulation of an immune response, drugs for immunocorrection. <p style="text-align: center;">List of practice.</p> <ol style="list-style-type: none"> 1. Register the result of agglutination test. 2. Register the result of gel immunoprecipitation test. 3. Register the result of complement fixation test. 4. Register the result of passive hemagglutination test. 5. Perform the slide agglutination test 6. Determine the immunoglobulins concentration. 7. Determine T-lymphocytes quantity in ready slide by immune rosettes method. 8. Determine phagocytosis indices in ready slides.
--	--

REFERENCES

1. *Khaitov, R. M.* Immunology : textbook / R. M. Khaitov. Moscow : GEOTAR-Media, 2008. 256 p.
2. *Paul, W. E.* Fundamental Immunology / W. E. Paul. 6th ed. Lippincott Williams & Wilkins, 2008. P. 1555.
3. *Abbas, A. K.* Cellular and molecular immunology / A. K. Abbas, A. H. Lichtman. 4th ed. Elsevier Inc., 2007. P. 476.
4. *Immunobiology* : immune system in health and disease / Ch. A. Janeway [et al.]. 5th ed. Garland Publishing, 2001. P. 735.
5. *Keogan, M. T.* Concise Clinical Immunology for Healthcare Professionals / M. T. Keogan, E. M. Wallace, P. O'Leary // Routledge. 2006. P. 426.

Учебное издание

Черношей Дмитрий Александрович
Слизень Вероника Вячеславовна
Канашкова Татьяна Александровна

ИММУНОЛОГИЯ

IMMUNOLOGY

Лабораторный практикум

На английском языке

9-е издание

Ответственная за выпуск Т. А. Канашкова
Компьютерный набор Д. А. Черношея
Переводчик Д. А. Черношей
Компьютерная вёрстка Н. М. Федорцовой

Подписано в печать 17.11.21. Формат 60×84/8. Бумага «Discovery».
Ризография. Гарнитура «Times».
Усл. печ. л. 7,44. Уч.-изд. л. 4,84. Тираж 169 экз. Заказ 12.

Издатель и полиграфическое исполнение: учреждение образования
«Белорусский государственный медицинский университет».
Свидетельство о государственной регистрации издателя, изготовителя,
распространителя печатных изданий № 1/187 от 18.02.2014.
Ул. Ленинградская, 6, 220006, Минск.

ISBN 978-985-21-0956-7



9 789852 109567