

МИНИСТЕРСТВО ЗДРАВООХРАНЕНИЯ РЕСПУБЛИКИ БЕЛАРУСЬ  
БЕЛОРУССКИЙ ГОСУДАРСТВЕННЫЙ МЕДИЦИНСКИЙ УНИВЕРСИТЕТ  
КАФЕДРА БИООРГАНИЧЕСКОЙ ХИМИИ

О. Н. РИНЕЙСКАЯ, К. Г. ПРОКОПЧИК

# БИООРГАНИЧЕСКАЯ ХИМИЯ ТЕОРЕТИЧЕСКИЙ КУРС

## BIOORGANIC CHEMISTRY THEORETICAL COURSE

Учебно-методическое пособие



Минск БГМУ 2008

УДК 577.1 (811.111) (075.8)  
ББК 28.072 (81.2 Англ–923)  
Р 51

Утверждено Научно-методическим советом университета в качестве  
учебно-методического пособия 25.06.2008 г., протокол № 11

Перевод с рус. яз. О. Н. Ринейской, К. Г. Прокопчик

Р е ц е н з е н т ы: зав. каф. общей химии, д-р биол. наук, проф. Е. В. Барковский; канд.  
мед. наук, доц. каф. биологической химии А. В. Колб

**Ринейская, О. Н.**

Р 51 Биоорганическая химия : теоретический курс = Bioorganic chemistry : theoretical  
course : учеб.-метод. пособие / О. Н. Ринейская, К. Г. Прокопчик ; пер. с рус. яз.  
О. Н. Ринейской, К. Г. Прокопчик. – Минск : БГМУ, 2008. – 150 с.

ISBN 978–985–462–868–4.

Издание охватывает основы дисциплины «биоорганическая химия» и базируется на современных представлениях о структуре и химических превращениях органических соединений, участвующих в процессах жизнедеятельности.

Предназначено для студентов 1-го курса, обучающихся на английском языке.

УДК 577.1 (811.111) (075.8)  
ББК 28.072 (81.2 Англ–923)

ISBN 978–985–462–868–4

© Оформление. Белорусский государственный  
медицинский университет, 2008

## Spatial Structure Of The Organic Molecules

Bioorganic chemistry is a young science. It appeared in its present form approximately in 1950 (nineteen fifty). This science studies the structure and properties of organic compounds which participate in the biological processes.

### Structure of carbon atom, hybridization of its atomic orbitals

Carbon is in the second row of the periodic table. Its electronic configuration is the following:  $1s^2 2s^2 2p^1 2p^1$ .

The orbital is a region where the probability of finding an electron is large, about 95 % of its time. There are 3 states of hybridization:  $sp^3$ ,  $sp^2$ ,  $sp$ . The first step to hybridization is the excitation of one electron.

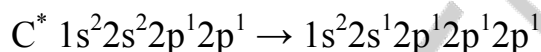

### $sp^3$ Hybridization

In 1931 L. Pauling gave the conception of the orbital hybridization. It was suggested that one s orbital and three p orbitals are mathematically mixed, or hybridized, to form four equivalent atomic orbitals called  $sp^3$  hybrids.

**one 2s orbital + three 2p orbitals  $\rightarrow$  four  $sp^3$  hybrid orbitals**

An  $sp^3$  hybrid carbon atom has a tetrahedral structure. All angles between any two bonds are approximately 109,5 (1 hundred and nine point five) degrees.

This is the so-called tetrahedral angle.

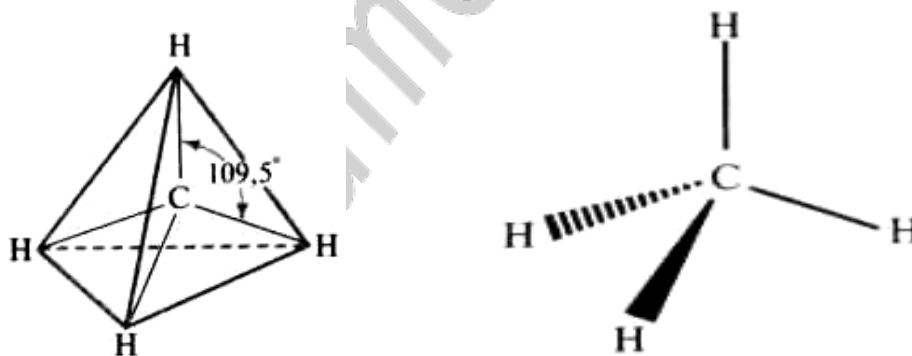

The stereochemical formulas are used to show a carbon atom tetrahedral configuration on the plane. These are the formulas of a structure with the included elements that show the spatial arrangement of atoms. For their illustration the tetrahedral model is oriented in the special way: the carbon atom with its two bonds is arranged in the plane, and then the 3<sup>rd</sup> bond is arranged in the front of the projection plane, and the 4<sup>th</sup> is behind the plane. The hydrogens are then located in the surrounding space by wedge with its basis directed towards the viewer (in front of the plane) and hatched (behind the plane) bonds.

An  $sp^3$  hybrid carbon atom forms  $\sigma$  bonds to other atoms — atoms of hydrogen, carbon, oxygen and so on.

### Molecular models

Organic molecules are generally not planar but three-dimensional objects. This results from a tetrahedral configuration of saturated carbon atoms.

Taking into account bond angles and bond lengths, it is possible to build three-dimensional models of organic molecules, or molecular models.

There are several types of models, among them the ball-and-stick based are the simplest. In these models the atoms are represented by balls of the equal radius which differ in color: black represents carbon (C); red is oxygen (O); blue is nitrogen (N); green is chlorine (Cl) and white is hydrogen (H). A chemical bond as a direct link between atoms can be modelled by linking balls (atoms) with sticks. Such molecular models visually show the relative spatial arrangement of atoms and the valence angles, but fail to show the actual shape of the molecule and space-filling inside of it.

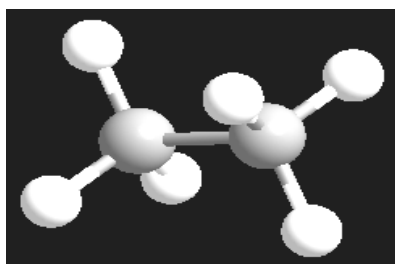

The filling of the intramolecular space and the actual shape of molecules are properly interpreted by the Stewart-Brigleb models.

They are called semi-spherical due to the atoms represented by spheres, with

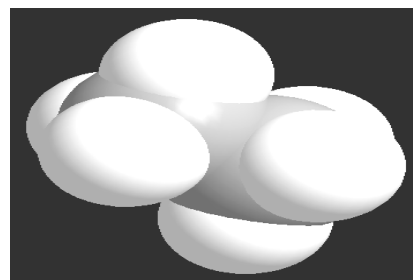

the radius proportional to their Van der Waals radius. The Van der Waals radius characterizes the dimension of the atom in reference to other atoms out of chemical bonding with it. For the  $sp^3$ -hybridized carbon atom its Van der Waals radius is equal to 0.18 nm. The sphere has 4 segments symmetrically cut with, the distance between them proportional to the covalent radius of the atom. The covalent radius of carbon atom is equal to 0.077 nm.

### Configuration and conformation of organic molecules

There are two types of bonds in the stereochemical formula of ethane:  $\sigma$ -bond C-H and  $\sigma$ -bond C-C, the latter resulting from the overlap of two  $sp^3$ -hybridized carbon atom orbitals. The C-C bond has the length of 0.154 nm and contains energy equal to 348 kJ/mol. The sigma bond is symmetrical with respect to rotation about the bond axis. The energetic barrier to rotation about sigma bonds is generally very low. **The definition:**

**The different spatial orientations of the atoms of a molecule that result from rotations or twisting about single bonds are called conformations.**

The conformations have different potential energy.

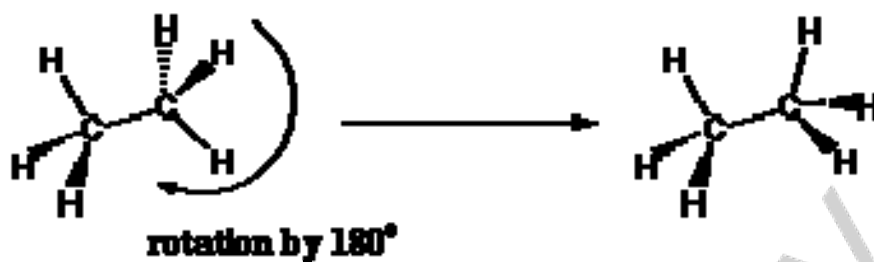

With the increase of C-C bonds in the chain the range of various spatial oriented forms also increase (these forms are called conformational stereoisomers, or conformers).

A Newman projection can be used to specify the conformation of a particular bond with clarity and detail. A Newman projection represents the head-on look down the bond of interest.

The circle in the Newman projection represents the atom in front of the bond, and the lines radiating from the center are the bonds of that atom.

The bonds of the rear atom emerge from the sides of the circle.

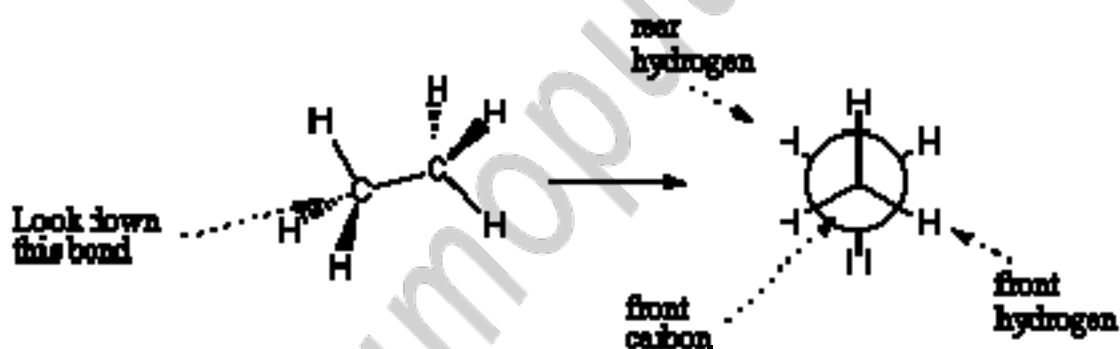

Newman projections can be characterized by the angles formed between bonds on the front atom and bonds on the rear atom. Such angles are called torsion (dihedral) angles. The minimum torsion angle is considered to be  $60^\circ$ , that is why we take into consideration only six conformations of all that may take place. The conformations which contain relatively high potential energy usually have the replacing groups arranged closely to each other. Such conformations are called eclipsed.

And ones which have the replacing groups arranged distantly and contain less potential energy are called staggered. The potential energy in the eclipsed conformer of ethane is 12 kJ/mol higher, than in the staggered conformer. This energy rate forms the energetic barrier of rotation resulting from bond-electron repulsions (be-

tween  $\sigma$ -bonds C-H) in their close arrangement in the eclipsed conformer. This increase of system energy is called torsion strain.

### Conformations of Ethane

While there are an infinite number of conformations about any sigma bond, in ethane two particular conformers are noteworthy and have special names. In the [eclipsed](#) conformation, the C-H bonds on the front and back carbons are aligned with each other with dihedral angles of 0 degrees. In the [staggered](#) conformation, the C-H bonds on the rear carbon lie between those on the front carbon with torsion angles of 60 degrees.

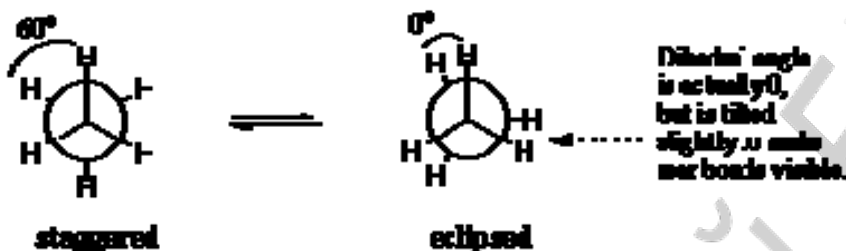

Energetically, not all conformations are equally favored. The eclipsed conformation of ethane is less stable than the staggered

conformation by 12 kJ/mol. The staggered conformation is the most stable of all possible conformations of ethane, since the angles between C-H bonds on the front and rear carbons are maximized at 60 degrees. In the eclipsed form, the electron densities on the C-H bonds are closer together than they are in the staggered form. When two C-H bonds are brought into a torsion angle of zero degrees, their electron clouds experience repulsion, which raises the energy of the molecule.

The eclipsed conformation of ethane has three such C-H eclipsing interactions, so we can infer that each eclipsed C-H "costs" roughly 3 kJ/mol.

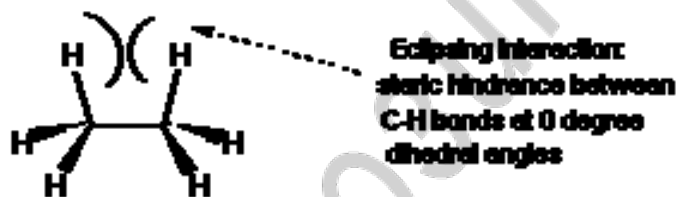

Eclipsing interactions are an example of a general phenomenon called [steric hindrance](#), which occurs whenever bulky portions of a molecule

repel other molecules or other parts of the same molecule. Because such hindrance causes resistance to rotation, it is also called torsional strain.

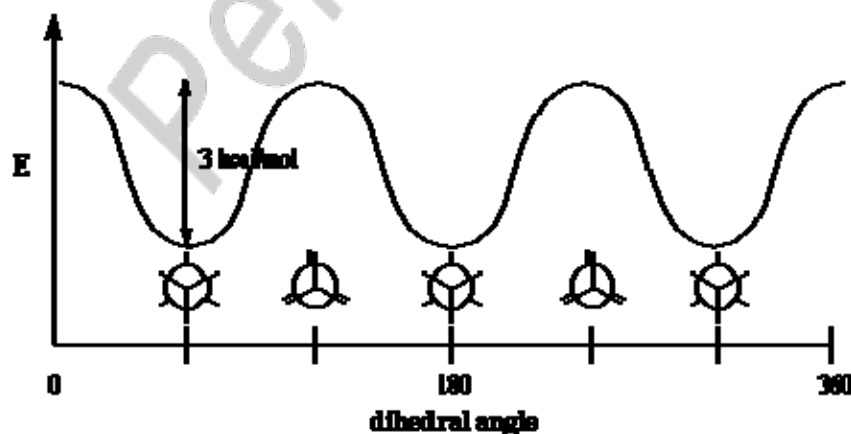

At room temperature, ethane molecules have enough energy to be in a constant state of rotation. Although the term "conformational isomer" is sometimes used as a synonym for conformations,

conformations of a molecule are not considered true isomers because of their rapid interconversion.

### Conformations of Butane

Four extreme conformations are possible for the butane molecule, if we consider rotation about the C2-C3 bond (in addition to conformations which arise after rotation about the terminal C1-C2 and C3-C4 bonds). There are two eclipsed conformations and two staggered conformations which are called skew, or gauche, and anti conformations. In the IUPAC stereochemical nomenclature all the four conformations are called synperiplanar, synclinal, anticlinal and antiperiplanar.

The eclipsed conformations possess maximum potential energy. They have not only torsional strain but also Van der Waals repulsions arising from the eclipsed pairs CH<sub>3</sub> and H or from two CH<sub>3</sub> groups. This type of interaction when two groups are forced to be closer than their atomic radii is called steric strain.

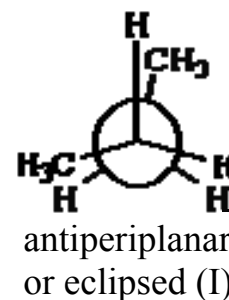
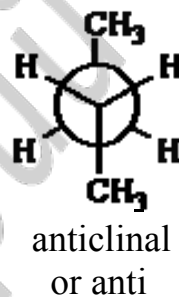
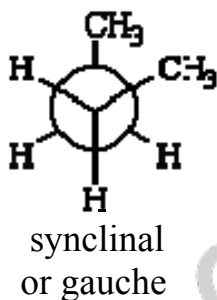
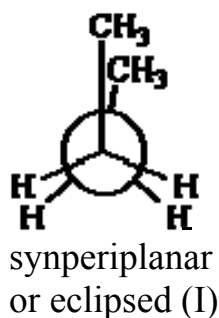

It is observed in the gauche conformation as well because the CH<sub>3</sub> groups are close enough to each other for repulsion and evaluated as approximately 3.5 kJ/mole. Obviously, the anti conformation is the most stable one because both torsional and steric strains are not revealed. To distinguish the different types of staggered and eclipsed conformations possible with butane the relationship between the methyl groups is often described using *syn/anti* and *coplanar/periplanar* terminology. Thus the most stable conformation results when the two methyl groups are *anti-periplanar*. The same principles just considered for butane can be applied to all alkanes. The most favoured arrangement for any alkane is that, in which all C-C bonds occupy the opposite positions, that is are in the anti conformations. Thus long-chain molecules have a tendency to take a zigzag shape in the space.

Unlike acyclic hydrocarbons, cyclic hydrocarbons may have strain which is inherent in their cyclic structures. This is called ring strain. Ring Strain consists primarily of two different kinds of strain: torsional strain and angle strain. Torsional strain arises, when bonds are not ideally staggered. Angle strain arises, when the C-C-C

bonds of the ring depart (because of geometric necessity) from the ideal tetrahedral angle preferred for  $sp^3$  carbon.

The chemical conformation of cyclobutane is not planar but folded or "puckered". One of the carbon atoms makes  $25^\circ$  angle with the plane formed by the other three carbons. In this way some of the hydrogen eclipsing interactions are reduced. The conformation is also known as a "butterfly".

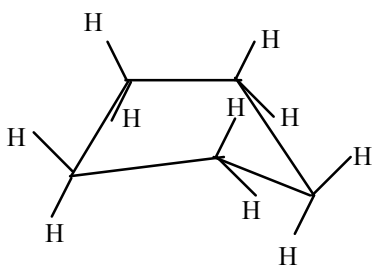

In substituted cycloalkanes both planar and puckered conformations exist. Because the energy difference between the two states can be small they can interconvert. The typical structure of cyclopentane is the "envelope" conformation. The dynamic flexibility of a five-membered ring is the best visualized in the view which simulates the equilibrium interconversion of the various conformational isomers.

The lowest energy conformation of cyclohexane is one in which each end of the molecule is "puckered", relative to the plane of the ring. This form is commonly called the "chair conformation", as it somewhat resembles a reclined lawn chair. Inspection of this structure shows that there are two types of hydrogens in the molecule; a set that is perpendicular to the plane of the ring (axial hydrogens) and a set which are more-or-less in the plane of the ring (equatorial hydrogens). The chemical reactivity of cyclohexane, however, is inconsistent with two types of hydrogens in a stable form of the molecule (for example, there is only one monochlorocyclohexane, not two, as would be predicted if axial and equatorial hydrogens could be replaced independently). The explanation for this fact is that the flexibility of cyclohexane allows for rapid ring inversion, in which one chair conformation is replaced by a second.

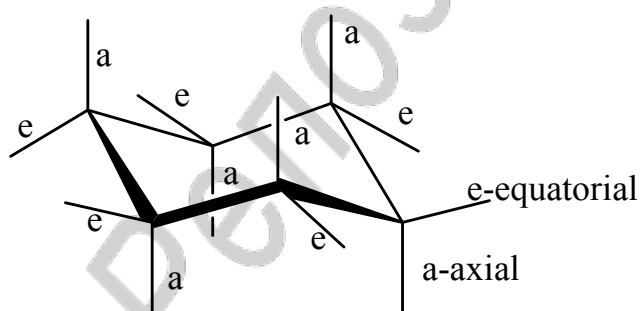

Intermediate between these two chair forms is an unstable conformation called "boat cyclohexane", in which both ends of the molecule are puckered in the same direction. The important thing to note about the process of ring inversion is that during ring inversion, all axial substituents are converted to equatorial substituents, and all equatorial substituents become axial.

The axial hydrogens in cyclohexane experience a slight amount of steric repulsion. More bulky groups, however, can interact strongly with other axial substituents, making it energetically unfavorable for these groups to occupy axial positions. These



unfavorable interactions can be seen below in the equatorial and axial representations of bromocyclohexane. In the equatorial conformation, the bromine is "sticking out" from the plane of the ring and is experiencing only minimal steric interactions with neighboring groups. In the axial conformation the Van der Waals radii of the bromine significantly overlaps with that of the two axial hydrogens. This type of steric interaction can also be clearly seen in the models for ethylcyclohexane.

### Stereoisomerism

Compounds that have the same molecular formula, but are not identical are called **isomers**. There are two main classes of isomers, constitutional isomers and stereoisomers. Constitutional isomers have the same number and types of atoms, but they are connected in the different sequence (they have a different "constitution").

Stereochemistry is a subdiscipline of chemistry, involves the study of the relative spatial arrangement of atoms within molecules and their influence on properties and reactivity of substance. The **configuration** of a molecule is the arrangement of its atoms or groups in space without regard to arrangements that differ only due to rotation about one or more single bonds.

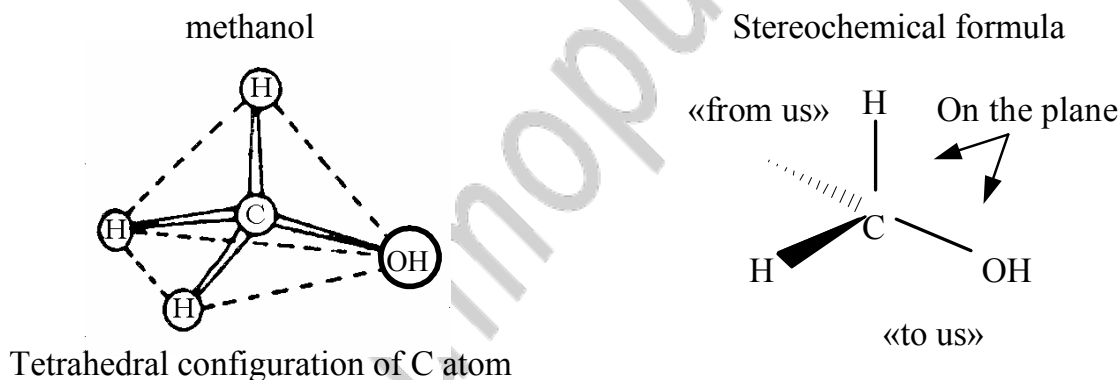

A carbon atom in the  $sp^3$ -hybridised state has tetrahedral configuration that is it is situated in the center of imaginary tetrahedron, but its 4 substituents are in the tetrahedron vertices. Tetrahedral configuration on the plane is illustrated with stereochemical formulas. For example, in the methanol stereochemical formula single lines show the bonds lying in the plane of the paper, thick line show that group (in particular H) lies in front of the paper and dotted line shows that group (H) lies behind the plane.

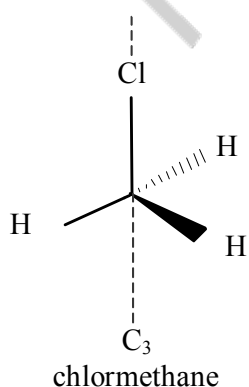

### Symmetry of molecules

All molecules may be characterised and categorised by their symmetry or symmetry elements within the molecule. Symmetry elements are the points, lines,

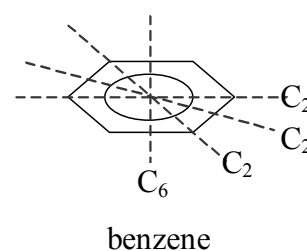

and planes with respect to which symmetry operation is performed. A symmetry axis and a symmetry plane are the most important among them. Rotation by  $360^\circ/n$  around any randomly chosen axis through the molecule returns it to the original position  $n$  times. So, this axis is called axis of symmetry (i. e. the rotation axis,  $C_n$  or  $n$ ).

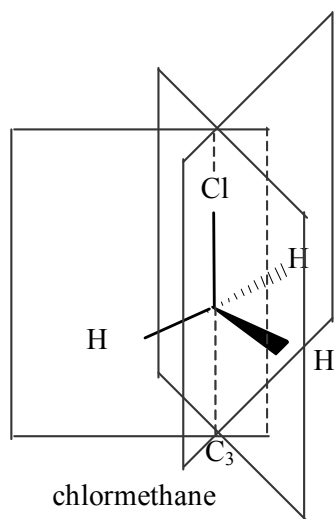

For example, chloromethane molecule has a symmetry axis  $C_3$  in the along the C — Cl bond. Benzene has 6  $C_2$  lying in the molecule plane and 1  $C_6$  that is perpendicular to the aromatic ring plane. The more symmetry axis order ( $n$ ), the more symmetry molecule is.

**A symmetry plane ( $\sigma$  or  $m$ ) is the plane through the molecule that cuts a molecule in such a way that 2 halves of the molecule are reflections of each other.**

### Methane symmetry

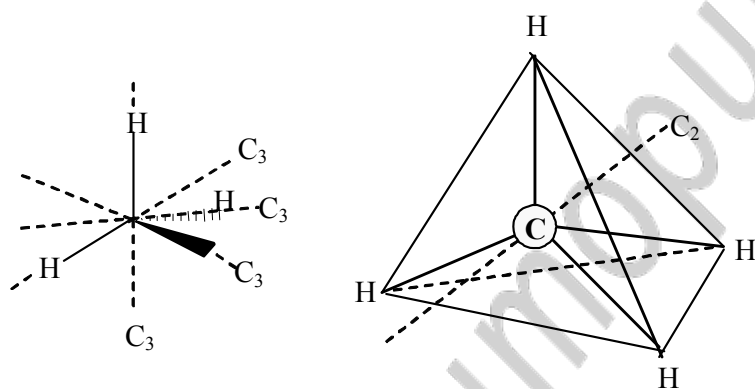

Most molecules possess more than one symmetry element. Methane molecule is the high symmetry molecule! It has 4  $C_3$  that go through a carbon atom and every hydrogen atom, 3  $C_2$  that go through a carbon atom and plane centre between hydrogens and 6 symmetry planes.

Asymmetry means that molecule possesses no symmetry operations except the identity.

An object that cannot be superimposed on its mirror image is called chiral

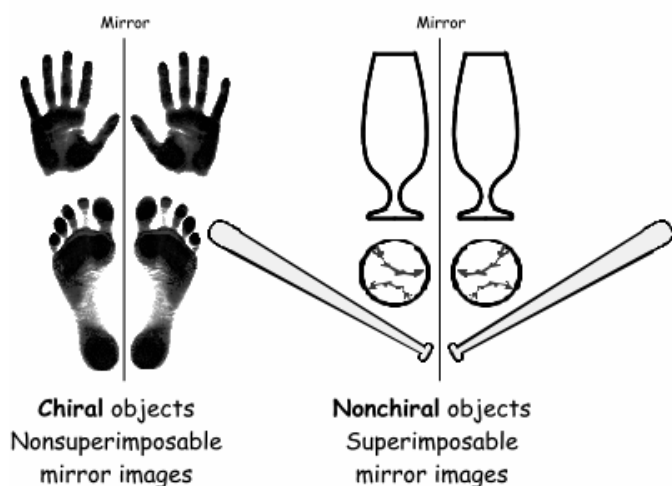

### Chirality

Any object which cannot be superimposed on its mirror image is chiral. If it can be superimposed on its mirror image it is achiral.

### Chiral molecules

A molecule which is made up of a tetrahedral carbon atom with four different substituents attached is an example of a chiral molecule. Such

a carbon atom is said to be asymmetric. A Chiral Carbon is a carbon atom that is bonded to four different groups.

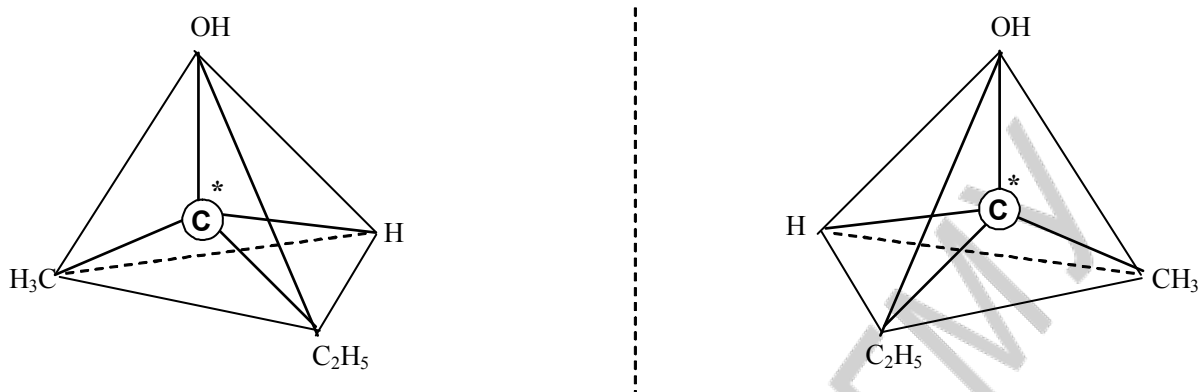

No matter how the molecule is rotated it cannot be made identical to its mirror-image form. Asymmetric (or chiral) carbon is designated with asterisk (\*).

### Optical activity

Chiral molecules possess the property of rotating the plane of polarised light when it is passed through a solution containing the substance. This property is called optical activity. The angle of rotation is measured in a device known as a polarimeter. Some chiral substances rotate the plane of polarisation to the right (clockwise), that is they are dextrorotatory (+). Others rotate the plane to the left (anticlockwise), and are called levorotatory (-). Another way of indicating the direction of rotation is by means of prefixes d and l. The symbols d (for dextrorotatory) for right rotation, and l (for levorotatory) for left were used.

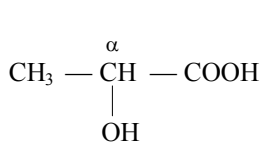

**Lactic acid**

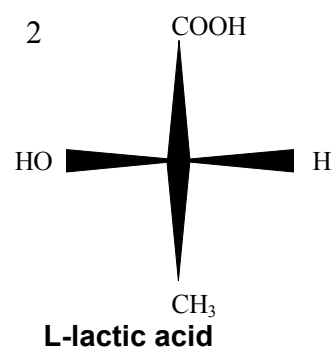
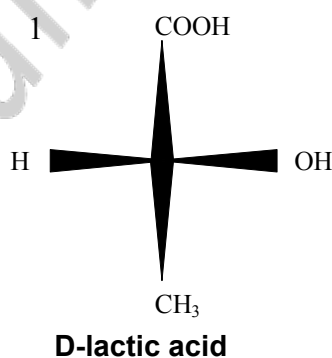

To write Fisher Projections it's necessary to conform the following rules:

- carbon chain is arranged vertically;
- the conversion of a perspective drawing to a Fischer projection requires rotating the molecule so that the "top" and "bottom" groups are oriented back, away from you;
- the tallest priority group is placed in the "top" position;

- the "right" and "left" groups are placed in a position where they are projecting outward towards you;
- all bonds are drawn as simple lines;
- the central carbon is always omitted.

For example, (+) D-glyceraldehyde and (-) L-glyceraldehyde.

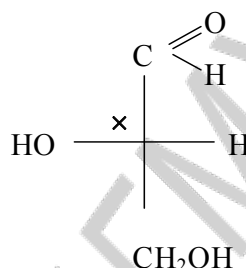
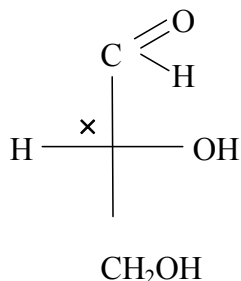

Stereoisomers which are related to each other as mirror images are called enantiomers, possess in achiral surroundings identical chemical and physical properties, except for a sign on optical rotation.

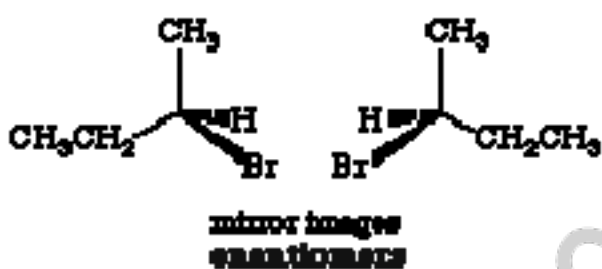

An equimolar mixture of enantiomers (means equal concentrations of both enantiomers) is known as a racemic mixture which doesn't possess optical activity.

Stereoisomers which are not enantiomers are called diastereomers.

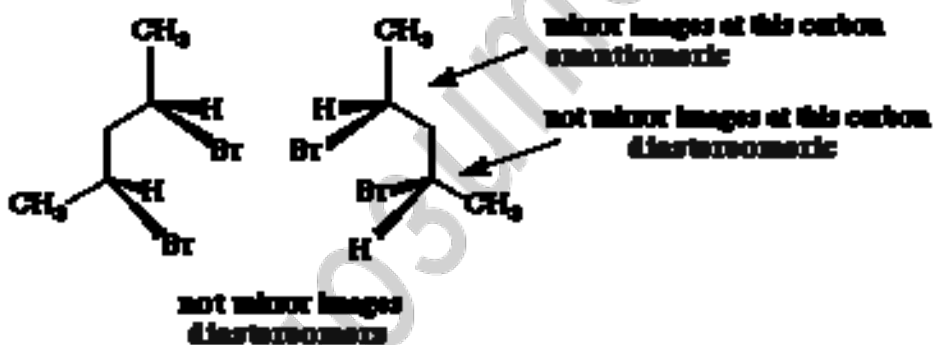

A third type of stereoisomer which must be considered is a meso compound. A meso compound contains at least two stereogenic centers, yet the molecule itself

is not chiral. This is because meso compounds contain an internal plane of symmetry; for example *cis*-1,2-dimethylcyclopentane.

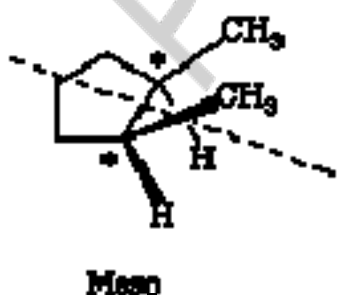

The number of stereoisomers depends on the number of chiral atoms and may be determined as:  $N=2^n$ , where N — the number of stereoisomers, n — the number of chiral centres.

**Malic acid** is a dicarboxylic acid. It contains one chiral atom and exists as 2 enantiomers.

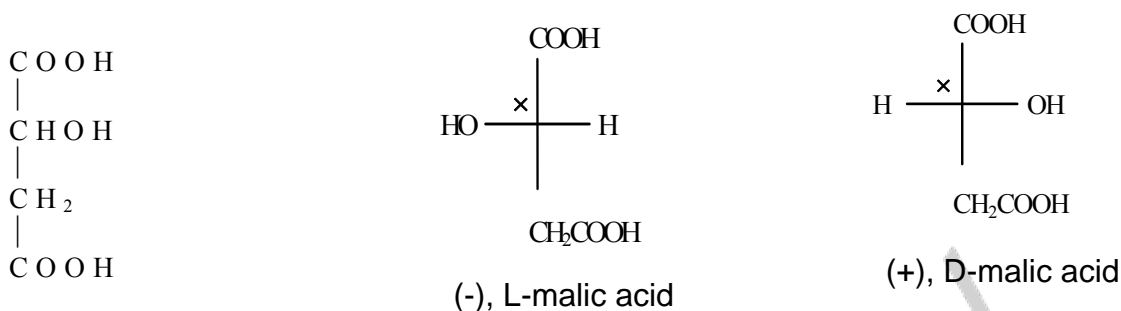

Natural malic acid is the L — malic acid. The salts and esters of malic acid are known as malates.

**Tartaric acid** (2,3-dihydroxybutanedioic acid) contains 2 chiral centres and has 3 stereoisomers. Meso-tartaric acid is achiral.

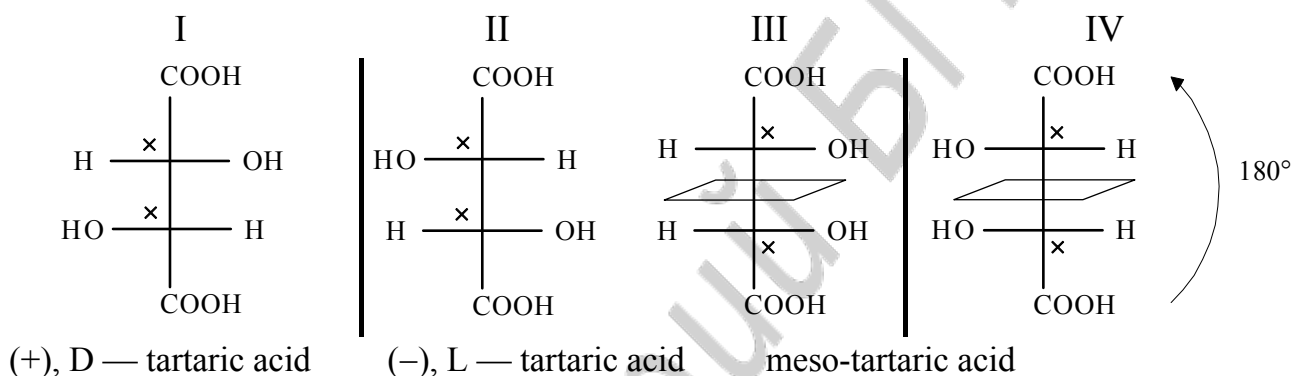

To describe stereoisomers the Cahn-Ingold-Prelog R, S-system is widely used. The R, S-system rules are the following:

1. Examine the four atoms directly attached to the chiral center in question. Assign priorities in order of decreasing atomic number. In case, when substituents are the same, compare the atomic numbers of the second atoms in each substituent, then the third, etc., until a difference is found.

2. Multiple bonds count twice (or three times) when examining substituents.

3. Once the priorities have been assigned, rotate the molecule in space so that the lowest priority group is pointing back.

Connect the three remaining groups in order of decreasing priority and examine the direction of the resulting rotation. Rotation, which is clockwise, is termed R (rectus; right) and rotation, which is counterclockwise, is termed S (sinister; left).

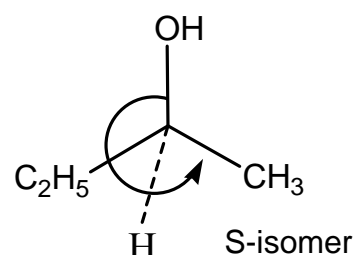
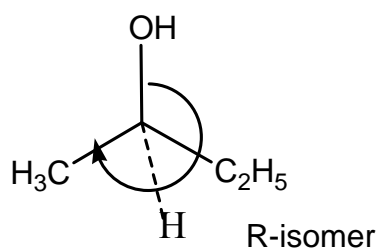
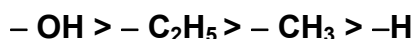
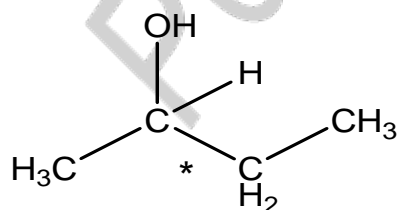

## Conjugation. Aromaticity of carbo- and Heterocyclic Compounds

2s Orbital mixes with 2 2p orbitals to form 3  $sp^2$  hybrids, which are also of the same length and strength. This is the  $sp^2$  hybridization.

**one 2s orbital + two 2p orbitals  $\rightarrow$  three  $sp^2$  hybrid orbitals**

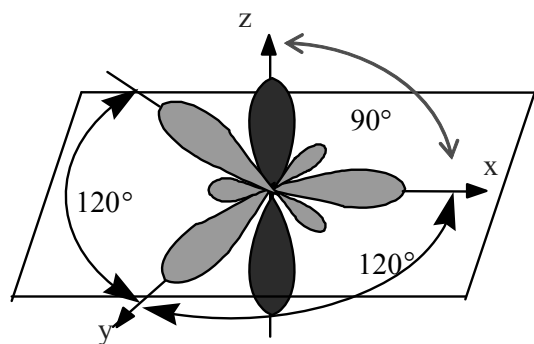

These hybrid orbitals lie on a plane at the angles of 120 degrees to each other. The remaining 2p orbital is perpendicular to the plane (flat) of the  $sp^2$  orbitals.

Therefore the  $sp^2$  hybrid carbon atom has a plane space structure. Carbon, which is in the state  $sp^2$  may be connected to at least one additional  $sp^2$  atom.

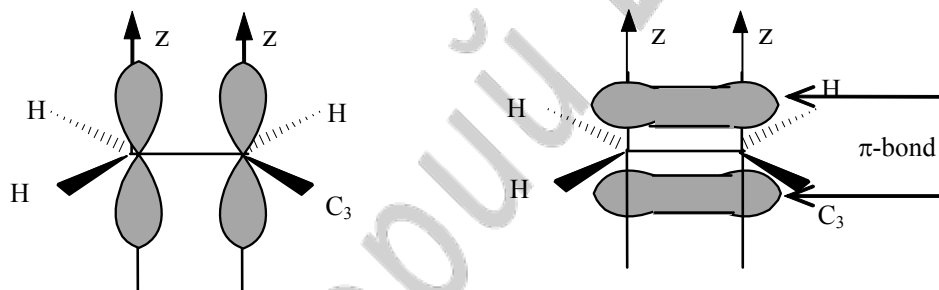

The figure shows how such hybridized carbon atoms in ethylene molecule form not only  $\sigma$  bonds, but also an additional bond by a p – p lateral or sideways overlap. This bond is called  $\pi$ -bond. It is a two-centered, localized bond. It is less strong, than a  $\sigma$ - bond and gives unsaturated compounds the possibility to enter the addition reactions. The rotation around the  $\pi$ -bond is impossible, that fact proves the existence of  $\pi$ -diastereoisomers (cis- and trans-configurations of stereoisomers). For example, unsaturated 9-octadecenic acid exists as cis-isomer (oleic acid, point of melting at  $14^\circ$ ) and trans-isomer (elaidic acid, melting at  $52^\circ$ ). Cis-oleic acid forms the biological lipid membrane. In the state of  $sp^2$ -hybridization a carbon atom is also present in carbonyl and carboxylic groups.

### The electronic structure of organic molecules

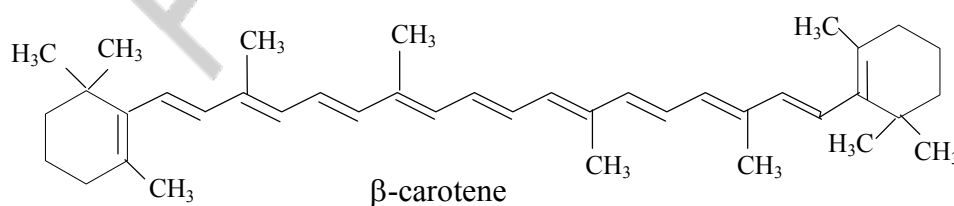

$\beta$ -carotene

There are many organic compounds, which molecules contain more than one multiple

(double or triple) bond. There are cumulated, isolated and **conjugated** multiple

bonds. The most interesting are **conjugated** double bonds, where double and single bonds alternate in the chain. There are many unsaturated and polyunsaturated compounds with conjugated double bonds, which play an important role in nature and biology. For example,  $\beta$ -carotene. It is a yellow-orange pigment in carrots that contains eleven conjugated double bonds.

### $\pi, \pi$ Conjugation

Conjugated dienes are similar to nonconjugated dienes in many but not all of their chemical properties. Conjugated dienes are more stable *than* nonconjugated dienes. An explanation for the higher stability of conjugated dienes can be given in describing the electronic structure of the conjugated systems by example of 1,3-butadiene.

This figure demonstrates the interaction between  $C_1$  and  $C_2$  carbon atoms and  $C_3$  and  $C_4$  atoms to form 2 double bonds.

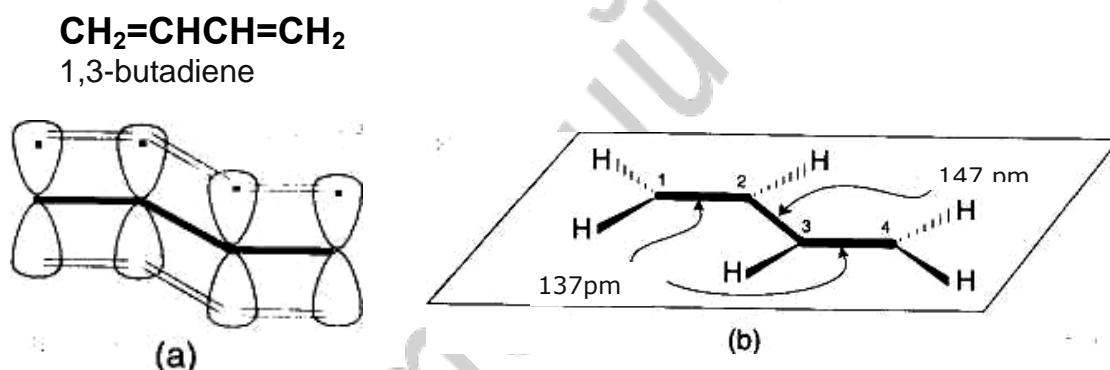

All carbons in the molecule are  $sp^2$ -hybridized. It means that this molecule ( $\sigma$ -skeleton) is planar (flat). Therefore, all  $p$  orbitals are parallel to each other and perpendicular to  $\sigma$ -skeleton. Parallel arrangement of the  $p$  orbitals provides the effective orbital overlap and the **delocalization** of electrons.  $p$  orbitals of the central carbon atoms are overlapped as well.

Delocalization of the electron cloud leads to lower-energy orbitals and increased stability of the molecule.

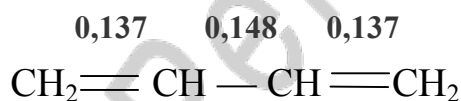

Another observational proof for the peculiar nature of conjugated dienes arises from X-ray structure analysis data determining bond lengths. Both double bonds of conjugated dienes are longer than those of ethylene, whereas the central C-C bond of 1,3-butadiene is considerably shorter than the single bond of ethane. It means that the C-2-C-3 bond of 1,3-butadiene has an intermediate value (147 pm) between a pure single bond (154 pm) and a pure double bond (133 pm) and possesses, therefore, a partial double-bond character. **The definition:**

**The type of orbital interaction when the  $p$  orbitals are delocalized over the entire  $\pi$  system is called  $\pi, \pi$  conjugation.**

$\pi, \pi$  Conjugated system may include heteroatoms.



### Energy of conjugation

The value of thermodynamic stability is expressed as the difference between the complete  $\pi$ -electron energy of the nonconjugated system (with localized double bonds) and the  $\pi$ -electron energy of the conjugated system:

$$E_{\text{conjug}} = E_{\text{nonconjug.system}} - E_{\text{conjug.system}}$$

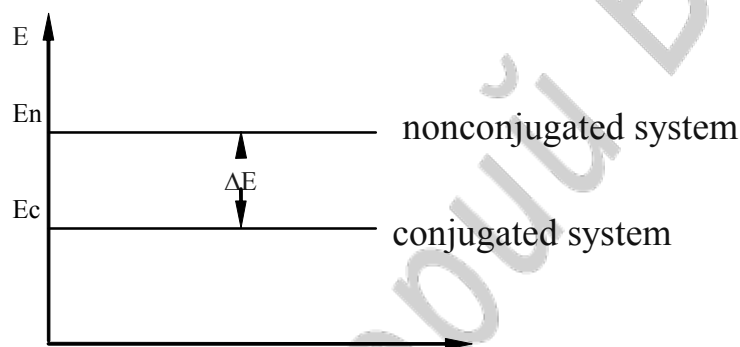

Not only molecules, but also free radicals and ions can be a conjugated system.

Another type of conjugation exists in compounds with a fragment  $>\text{C}=\text{CH}-\text{X}$ , where  $\text{X}$  is an atom possessing a lone pair of electrons. In this case 3 orbitals are delocalized, two  $p$  orbitals of the double bond and one  $p$  orbital of the atom  $\text{X}$ .



### The definition:

**$p, \pi$  Conjugation — the interaction between  $\pi$ -bond orbitals and  $p$  orbital of an adjacent atom.**

The conjugation is the phenomenon, which explains high stability and specific chemical properties of conjugated molecules, ions, or radicals. The concept of conjugation is useful in understanding chemical and biochemical processes.

### Aromaticity



The molecular formula of Benzene is  $C_6H_6$ . It is a highly unsaturated compound. Physical measurements show that benzene is flat. It is a symmetrical molecule with a shape of a regular hexagon. Its all carbon-carbon bond lengths are 140 pm. All carbon atoms are  $sp^2$  hybridized.

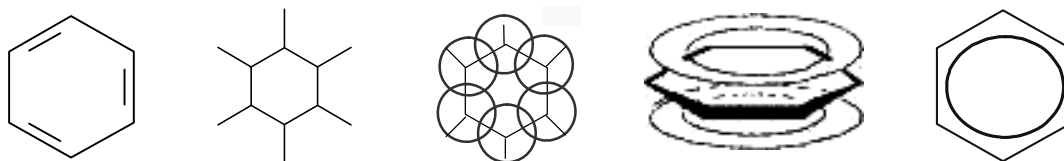

Two  $sp^2$  orbitals form  $\sigma$  bonds with adjacent carbons. The third  $sp^2$  orbital of each carbon forms the C-H bond. In addition, each carbon has a p orbital with one electron. All six p orbitals are perpendicular to the plane of the six-membered carbon framework. Each p orbital overlaps equally well with both neighboring orbitals to form a cloud of six p electrons completely delocalized around the ring. Thus, the benzene molecule represents a circular  $\pi$ - $\pi$ -conjugated system with two doughnut-shaped clouds of electrons, one above and one below the ring. For this reason, a more satisfactory representation of the benzene molecule might be a hexagon with the inscribed circle.

Electron delocalization results in enhanced stability of benzene. For example, conjugation energy for benzene is 151 kJ/mol. Benzene has aromatic properties.

A molecule has aromatic properties if it satisfies the following criteria:

- 1) all atoms are  $sp^2$  hybridized, therefore a molecule has a planar structure;
- 2) a molecule has a cyclic system of conjugation;
- 3) a cyclic system of conjugation contains  $(4n + 2)$   $\pi$  electrons, where  $n$  is an integer (0, 1, 2, 3, etc.).

This is known as Huckel's  $(4n + 2)$  rule. Such molecules as naphthalene, phenanthrene satisfy all the requirements of aromaticity. Some heterocyclic aromatic compounds also have aromatic properties.

**Pyridine** is a six-membered heterocycle with a nitrogen atom. In this molecule Nitrogen has the following electronic configuration.

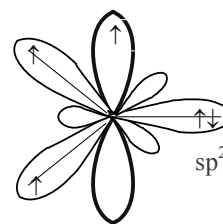
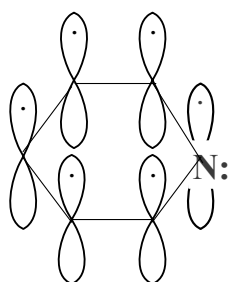
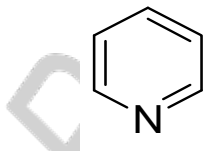
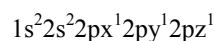

Nitrogen is  $sp^2$ -hybridized. The two hybrid orbitals of nitrogen form two  $\sigma$  bonds. The remaining hybrid orbital of nitrogen possesses an unshared electron pair

and does not form a bond. The unhybridised  $p$  orbital of nitrogen (with one electron) is perpendicular to the plane of the ring and overlaps the  $p$  orbitals of carbons to form an aromatic cloud, containing six  $p$ -electrons. Pyridine is very similar to benzene in its electronic configuration, i. e. pyridine is **isoelectronic to benzene**. Thus, pyridine satisfies all criteria of aromaticity:

- 1) all atoms in the cycle are  $sp^2$ -hybridized;
- 2) it is a planar compound with cyclic conjugation;
- 3) the  $p$ -orbital system contains  $6p$  electrons, where  $n$  is 1.

Pyridine is  $\pi$ -deficient heterocycle, because it contains the electronegative nitrogen atom.

**Pyrrole** is a five-membered heterocyclic compound. It contains all the carbons and the nitrogen atom in the  $sp^2$ -hybridized state.

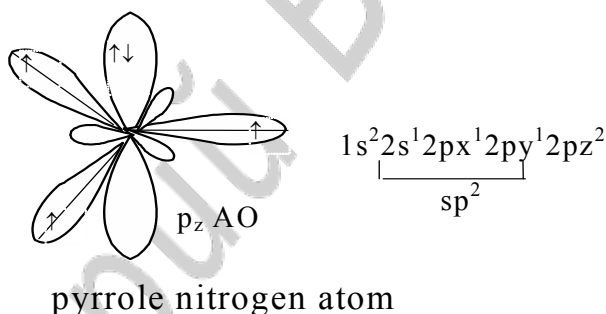
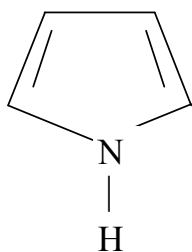

All 3 hybrid orbitals of nitrogen form 3  $\sigma$  bonds, 2 orbitals — with the carbon atoms and the third orbital with hydrogen. The nitrogen lone pair of electrons interacts with unhybridized  $p$  orbital of carbon atoms and participates in the formation of a delocalized electron cloud. Pyrrole is therefore an aromatic compound.

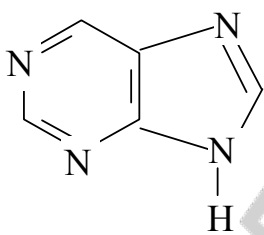

**Purine.** The most important fused-ring heterocyclic system from a biological viewpoint is purine. It represents a combination (fusion) of two heterocyclic compounds, both with two nitrogens, one six-membered (pyrimidine) and other five-membered (imidazole).

### Electronic effects of organic molecules

We generally meet with covalent chemical bonds in organic molecules, because their atoms do not differ greatly in electronegativity. There is a nonpolar covalent bond and a polar covalent bond. A nonpolar covalent bond is formed by atoms of the same electronegativity. A polar covalent bond is formed by two atoms of different electronegativity. The presence of a polar  $\sigma$  or  $\pi$  bond in an organic molecule results in polarization of neighbouring atoms. **The definition:**

**The inductive effect is the electron density shifting of a  $\sigma$  bond in response to the atom with greatest electronegativity.**

The inductive effect is symbolized by the letter *I*. There is an electron-withdrawing and electron-donating (electron-releasing) inductive effect. An electron-withdrawing or negative inductive effect is designated as  $-I$ . An electron-donating or positive inductive effect is designated as  $+I$ . In the first case electron density at the nearby atom is decreased, in the second case it is increased. The inductive effect of hydrogen is zero.

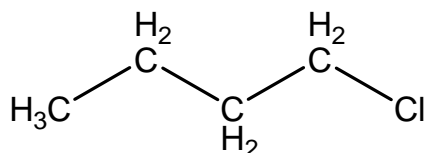

For example, chlorobutane. A chlorine atom has more electronegativity than a carbon atom and this atom shifts electronic density to itself. A chlorine possesses a partial negative charge and carbon atom has a partial positive charge. Therefore, there is polarization of all bonds.

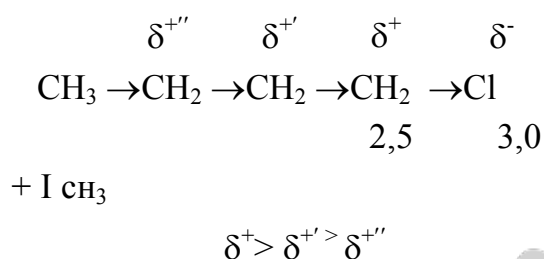
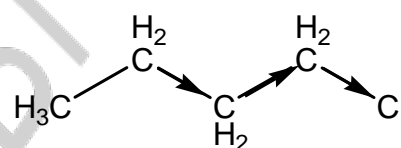

The effect of a substituent is the strongest on the neighbouring atom and decreasing along the carbon chain. Thus, the inductive effect is fading and it extends over three (maximum four) bonds.

A more pronounced electronic effect is observed in molecules having conjugated fragments. In such case the polarization effect of a substituent extends through the entire system of conjugation. **The definition:**

**Mesomeric (or resonance) effect is the electron density shifting caused by a substituent in conjugated system.**

The mesomeric effect is symbolized by the letter *M*. There is an electron-donating (designated  $+M$ ) or electron-withdrawing (designated  $-M$ ), like in case of the inductive effect

The  $-M$  effect of the functional group leads to decreased electron density on the all carbons of the remaining part of the molecule (as compare with unsubstituted compounds such as ethylene and benzene). The positive mesomeric effect is observed in most  $p,\pi$ -conjugated systems. In such a case a substituent with a lone pair of electrons donates electrons to the neighbouring benzene ring or a  $\pi$ -bond.

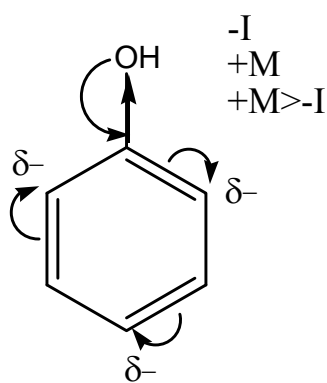

This fig. demonstrates an electron density distribution in the phenylamine molecule. An amine group has a negative inductive effect. Since phenylamine represents a conjugated system, an amine group possesses mesomeric effect. And since a nitrogen atom has a lone pair of electrons, an amine group possesses a positive mesomeric effect. Thus an amine group donates electrons to the neighbouring benzene ring.

In contrast, an aldehyde group in the benzaldehyde withdraws the electron density from the benzene ring to itself. The third and the fifth carbon atoms acquire a partial negative charge.

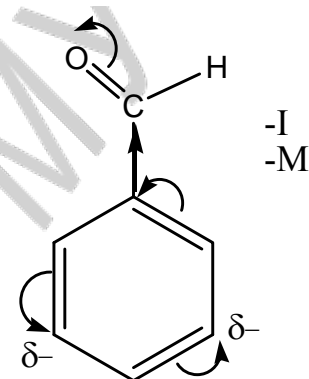

Thus, the mesomeric effect of a substituent can only be observed in the conjugated systems.

### Electronic effects of the substituents

Substituent	I-effect	M-effect	Correlation	Character
Alkyls	+I	no M	-	Electron donor
NH <sub>2</sub>	-I	+M	+M > -I	Electron donor
—OH, —SH	-I	+M	+M > -I	Electron donor p
—O—R	-I	+M	+M > -I	Electron donor
Halogens	-I	+M	-I > +M	Withdrawer
	-I	-M	-I, -M	Withdrawer
	-I	-M	-I, -M	Withdrawer
—SO <sub>3</sub> H	-I	-M	-I, -M	Withdrawer
—NO <sub>2</sub>	-I	-M	-I, -M	Withdrawer

## Acidity And Basicity Of Organic Compounds

Acidity and basicity are the main notions determining many fundamental physico-chemical and biochemical properties of organic compounds. First of all, acid and basic catalyses are the most widespread enzymic reactions. Besides, acid-base behaviour of organic compounds helps explain much of their biochemical properties.

At present, there are 2 main concepts of acids and bases in organic chemistry. According to the Brønsted theory, an acid is a proton donor, and a base is a proton acceptor. An acid and a base can be neutral molecules or ions.

In a general sense, an acid-base reaction can be expressed in the following way

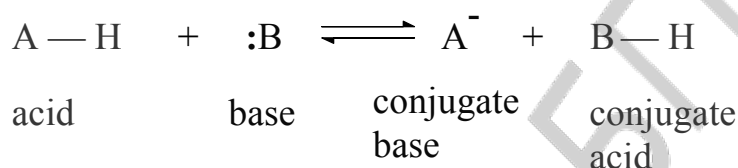

According to the Lewis theory, an acid is an electron pair acceptor, and a base is an electron pair donor. Lewis bases are also Brønsted bases; however, many Lewis acids, such as  $\text{FeCl}_3$ ,  $\text{AlCl}_3$  and cations, are not considered Brønsted acids.

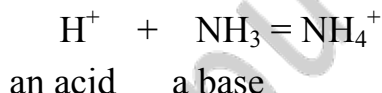

Acids differ greatly in their proton-donating properties. The acidity constant is a quantitative characteristic of acid strength. Acid strength is often expressed as  $\text{pK}_a$ , which is equal to the negative logarithm of the acidity constant. A stronger acid has a lower  $\text{pK}_a$ , and a weaker acid has a higher  $\text{pK}_a$ .

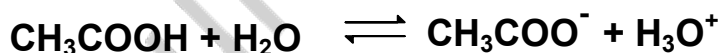

$$K = \frac{[\text{CH}_3\text{COO}^-][\text{H}_3\text{O}^+]}{[\text{CH}_3\text{COOH}][\text{H}_2\text{O}]}$$

$$K_a = K[\text{H}_2\text{O}] = \frac{[\text{CH}_3\text{COO}^-][\text{H}_3\text{O}^+]}{[\text{CH}_3\text{COOH}]}$$

$$\boxed{\text{pK}_a = -\lg K_a}$$

The Brønsted definition of acidity is extremely useful in organic and bioorganic chemistry because almost all organic compounds contain hydrogen and therefore they are potential acids. Usually, organic acids are classified into

- OH acids (carboxylic acids, alcohols, and phenols);
- SH acids (thiols);
- NH acids (amines, amides, some heterocycles, and ammonium);
- CH acids (hydrocarbons and their derivatives).

An acid and a base can be neutral molecules or ions.

A part of a molecule that involves hydrogen together with an atom attached to it is called an acidic site.

If  $pK_a$  values are not available, we are able to compare the Brønsted acids according to their conjugate bases stability (anions).

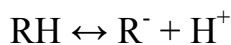

The more stable is an anion, the stronger is an acid. The following factors influence the stability of conjugate bases:

- electronegativity and polarizability of the atom in the acidic site;
- delocalization of a negative charge due to the effect of substituents in a molecule.

### Electronegativity and polarizability of the atom

The greater electronegativity of an atom in the acid side, the more stability of conjugate bases is observed within one row of the periodic table. Oxygen has more electronegativity than nitrogen and carbon. It possesses higher ability to hold a negative charge. For this reason, alcohols are stronger as acids than amines. And alkanes show extremely low acidity. In the following row the acidity decreases.



Another stabilizing factor is the **polarizability** of an element in the acidic site. This term means the ability of the electrons to respond to a changing electric field. Relative polarizability increases within one group of the Periodic Table from top to bottom because a larger atom has more possibility for delocalization of a negative charge, than a smaller atom. Let us compare the acidity of ethanol and ethanethiol.

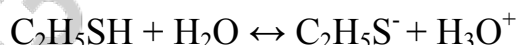
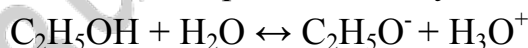

The size of the sulfur atom is larger than that of oxygen. Therefore, the negative charge in a thiolate ion,  $RS^-$ , is delocalized more effectively in comparison with an alkoxide ion.

The difference in acidity of thiols and alcohols is displayed in the reactions of substitution. Alkoxides can be obtained only in the reaction of alcohols with metals.

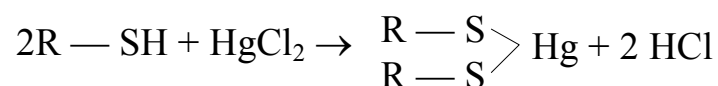
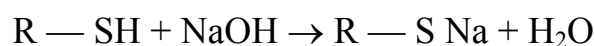
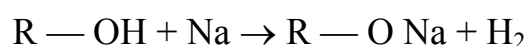



Easiness and reversibility of reactions in the system thiol-disulfide play a significant role in the formation of a three-dimensional structure of proteins.

### Charge delocalization in an anion

Let us compare the acidity of the phenol and ethanol. We can write the reaction of dissociation in such a way.

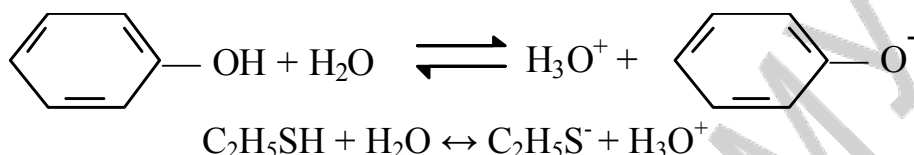

The stability of phenoxide is higher, because the negative charge is delocalized by conjugation. Phenols are stronger acids than alcohols.

The carboxylate ion is also an oxygen anion, but the negative charge is delocalized over both oxygen atoms through p,  $\pi$  conjugation. This results in stabilization of the anion. In resonance terms, the carboxylate ion is a stabilized resonance hybrid of two equivalent structures neither of which contains a localized charge.

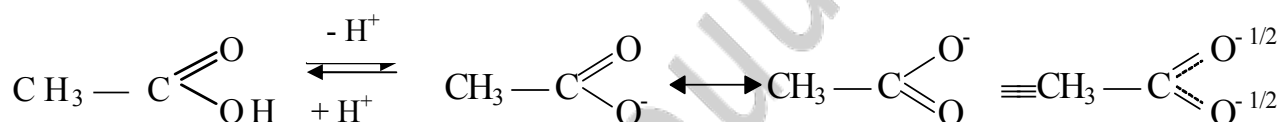

### Substituent Effects on acidity

Other factors that stabilize a conjugated base result in the increased acidity. It might be the electron-withdrawing group disposed near an acidic site. Electron-withdrawing substituents shift inductively electron density from the anionic site. They delocalize the negative charge on the carboxylate ion, stabilizing it, and increasing acidity. Let us compare the acidity of the propanic acid and lactic acid.

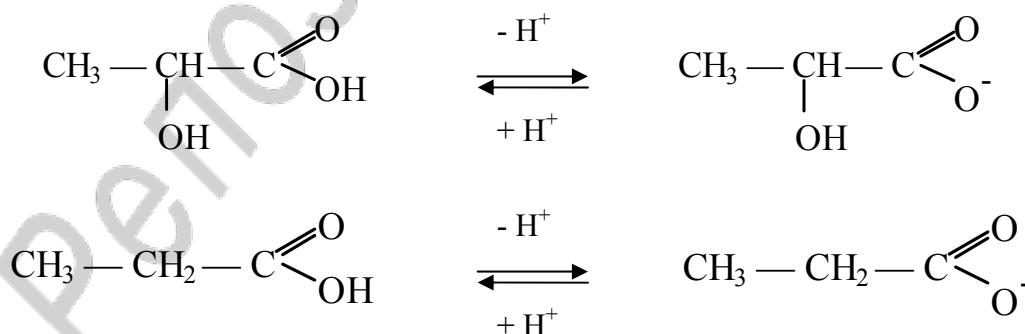

The conjugate base of lactic acid is more stable, because lactic acid contains a hydroxyl group, which is the electron-withdrawing substituent. It shifts the electronic density to itself, delocalizing the negative charge, stabilizing anion. Therefore, lactic acid is more stronger acid than propanic acid.



## Basicity

Organic bases are classified into n-bases and  $\pi$ -bases. Any anion or neutral molecule, containing heteroatom with a lone pair of electrons, can act as a base. This is the n-bases.

They are further classified into the following types, depending on the nature of heteroatom, which represents the basic site:

- N-bases (amines and many heterocycles);
- O-bases (alcohols, phenols, ethers, and compounds with the  $>C=O$  group);
- S-bases (thiols and sulfides).

An organic molecule, that contains a  $\pi$ -bond, is a  $\pi$ -base.

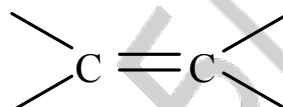
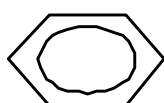

Bases differ greatly in their proton-accepting properties. Base strength is expressed as  $pK_{BH^+}$ . A stronger base has a higher  $pK_{BH^+}$ , a weaker base has a lower  $pK_{BH^+}$ .

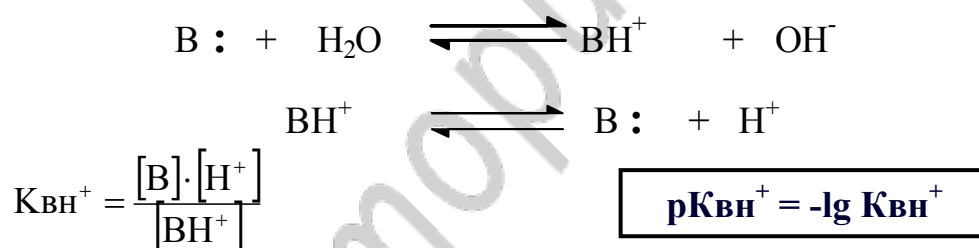

### The meanings of $pK_{BH^+}$ of some bases

NaOH	More than 14
Ethylamine	11
Ammonia	9
Quinine	8
Aniline	5
Nitroaniline	1

The strength of bases depends on electronegativity and polarizability of the atom of the basic site. Within one row of the Periodic Table, an atom with higher electronegativity is less capable of proton acceptance; therefore amines are more basic than alcohols. When we compare basicity of alcohols (as O-bases) and thiols (as S-bases), the difference in polarizability of oxygen and sulfur should be taken into consideration.

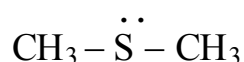
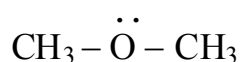

The size of the sulfur atom is larger than that of the oxygen atom; therefore electron density is less on sulfur. For this reason thiols are not able to form a strong bond with a proton, i. e. they are weaker bases than alcohols.

Thus we can say, the strength of bases with the same R substituents increases in the following way:



Aliphatic amines are stronger than aromatic amines, because the nitrogen lone pair of electrons is delocalized by orbital overlap with the aromatic  $\pi$ -electron system through p, n conjugation. They are, therefore, less available for proton acceptance.

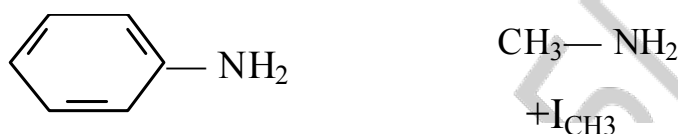

### The acid-base reactions



Many organic compounds are **amphoteric**. That is, they are capable functioning either as an acid or as a base, depending on the circumstances. Typical examples of these compounds are natural (or protein) amino acids. Amino acids have two independent functional groups.

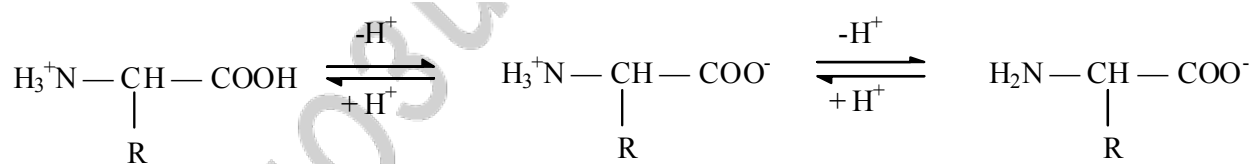

The presence of an acidic site (COOH) and a basic site (NH<sub>2</sub>) in the same molecule results in an acid-base interaction to produce a salt-like structure. Therefore, the real structure of amino acids in neutral a solution and in a crystalline state is a **dipolar ion** structure, sometimes called **zwitterion** (from the German *Zwitter* — hybrid).

## Mechanisms Of Organic Reactions

While studying organic chemical reactions two aspects should be taken into account: what types of reactions exist and how a reaction proceeds. We'll start with the types of reactions.

Organic reactions can be grouped into several types according to the overall result. They are:

- addition reactions;
- elimination reactions;
- substitution (or displacement) reactions;
- rearrangements (or isomerization reactions);
- oxidation and reduction reactions;
- acid-base interactions.

Chemical equations express the *overall* result of chemical transformation. They show the structures of reactants and products, but they tell us nothing how the reactants are turned to the products. **The definition of the reaction mechanism:**

**It is a step-by-step description of all changes in reacting compounds that occur at the molecular level, as the reactants become products.**

The mechanism describes which bonds are broken and which bonds are formed and in what order. It takes into account energy changes on the pathway from the reactants to the products including relative stability of intermediates formed in the reaction. The complete mechanism must also include the relative rates of the steps and stereochemical result of the reaction.

### Radical and Polar Processes

All reactions of organic compounds involve the breaking and making of covalent bonds. If we consider molecule A:B, its covalent bond may break in the following ways:

1.  $A:B \rightarrow A\cdot + B\cdot$
2.  $A: \mid B \rightarrow A: + B$
3.  $A \mid :B \rightarrow A + B:$

In above (1) the bond is broken so that A and B retain one of the bond electrons and cleavage leads to the neutral fragment A· and B·. This type of bond breaking is called homolysis. The neutral fragments A· and B· are called radicals, or free radicals. Radicals always contain unpaired electrons.

In (2), (3) bond cleavage leads to the charged fragments or ions. This type of bond cleavage is called heterolysis.

**Radical reactions.** A free radical X' can take away a part from a molecule A-B, for example, a species A' yielding a product A-X and leaving behind a new radical B'. The net result of the reaction is radical substitution:

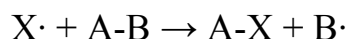

These reactions are typical for nonpolar organic compounds.

**Polar reactions.** These reactions occur as a result of attractive forces between positive and negative charges (full or partial). The most organic substrates are electrically neutral, certain bonds within a molecule are polar. The explanation of this fact is the difference of atom electronegativity. Polar reagents of different types can react with organic substrates. Polar reactions are very common in organic chemistry.

### Types of Reagents

Two types of reagents take part in a polar reaction, namely the electron-poor reagent X<sup>+</sup> or the electron-rich reagent Y<sup>-</sup>. The electron-poor reagent has an electron-poor site and seeks electrons in the substrate. The electron-rich reagent has an electron-rich site and can form a bond by donating a pair of electrons to an electron-poor site in the substrate.

Polar reagents are classified as **electrophiles** and **nucleophiles**. An electrophile is an electron-poor reagent; a nucleophile, by contrast, is an electron-rich reagent. Electrophiles are often positively charged. Typical electrophiles are halonium ions (Cl<sup>+</sup> and Br<sup>+</sup>), a proton, carbocations, or neutral molecules such as sulfur trioxide, SO<sub>3</sub>, or compounds of the general formula R-X, where X is an electron-withdrawing group. Nucleophiles are often, though not always, negatively charged. The most widely known nucleophiles are alkoxide ions, a hydroxide ion, thiolate ions, halide ions, a hydride ion (H<sup>-</sup>), carbanions, and many neutral compounds such as water, alcohols, thiols, ammonia, and amines.

**Free radicals.** These neutral species contain an atom with an unpaired electron in its outer shell; they are usually highly reactive for this reason. They can be produced from molecules on heating or by ultraviolet radiation. A compound that possesses unpaired electrons in an outer shell is ordinary molecular oxygen. On the basis of paramagnetic properties and the interatomic distance (121 pm) which is much shorter than the length of a single bond O-O (148 pm), the O<sub>2</sub> molecule can be described as a biradical. As it is well known, oxygen is responsible for many oxidation reactions both *in vitro*, including industrial processes, and *in vivo*, in living systems. Thus, taking into consideration a type of reaction and the nature of reagents we can classify addition reactions as electrophilic, nucleophilic, and radical ones. Mechanisms of these reactions are designated by the symbols  $A_E$ ,  $A_N$  and  $A_R$ , respectively.

Substitution reactions can be classified in a similar way as electrophilic, nucleophilic, and radical ones, using the symbols  $S_E$ ,  $S_N$  and  $S_R$ , respectively.

There are three main types of hydrocarbons, depending on the nature of carbon-carbon bonds in a molecule:

- saturated hydrocarbons that contain single C-C bonds only;
- unsaturated hydrocarbons containing multiple carbon-carbon bonds: a double bond (or bonds), a triple bond (or bonds), or their combination;
- aromatic hydrocarbons.

### Saturated Hydrocarbons

These hydrocarbons can be subdivided into two groups, namely, **alkanes**, compounds with an open carbon chain (linear or branched), and **cycloalkanes**, compounds with a cyclic carbon skeleton. Alkanes and cycloalkanes (except for cyclopropane) possess very similar chemical characteristics. These compounds contain non-polar and strong C-H and C-C bonds only therefore they are relatively unreactive.

**Halogenation of Alkanes** requires violent conditions

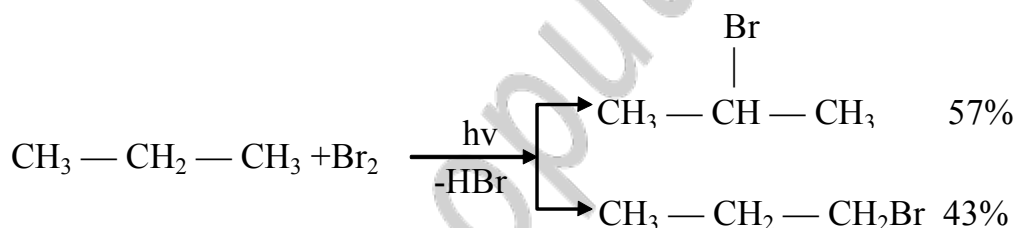

The first step is the **chain-initiating** step that lies in the breaking of the halogen molecule into two halogen atoms. The Br-Br bond is much weaker than the C-H and C-C bonds in propane, and is therefore the easiest bond to split, whereas the alkane remains unchanged.

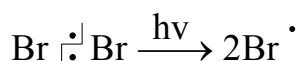

In the second **chain-propagating** step, a very reactive bromine atom can collide with a propane molecule, abstracting a hydrogen atom and producing a molecule of HBr and a highly reactive carbocation radical.

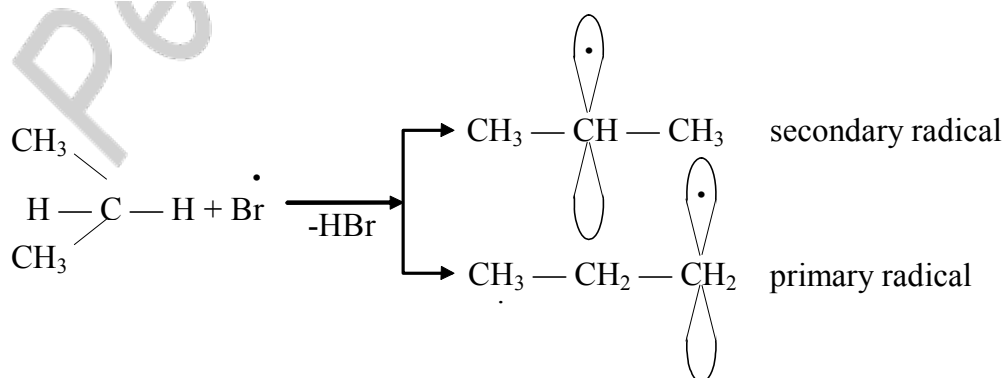

Then they react with a bromine molecule to give the following products: 2-bromopropane and 1-bromopropane and a new bromine atom. A secondary radical has more stability because it is stabilized by +I of 2 methyl groups. The prevalent formation of one of the possible products, which is called **regio-selectivity** of the reaction, can be explained by comparative stability of alkyl radicals. A bromine atom formed at this step can further react with propane to continue the chain. This type of a sequential mechanism is called a **chain reaction**.

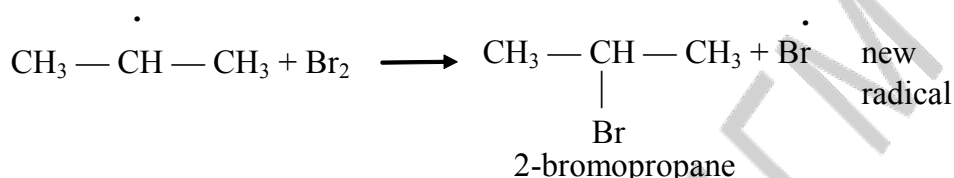

A chain reaction can be ceased if any two radicals combine. No new radicals are formed in these reactions as shown above in the **chain-terminating** steps.

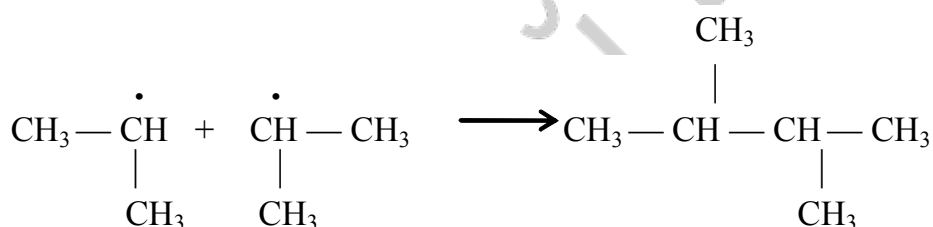

### Cyclopropane

#### BENT BONDING IN CYCLOPROPANE

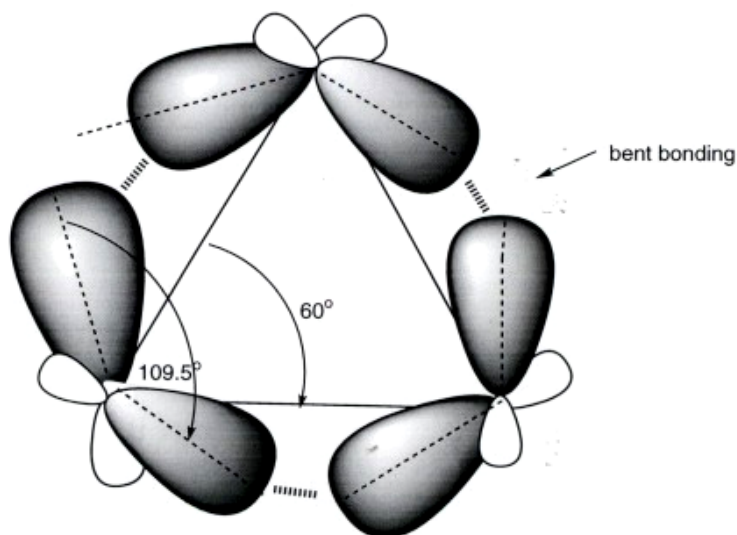

NOTE THAT SIGMA BONDING INVOLVES "END-ON OVERLAP" AND PI BONDING INVOLVES "SIDELONG" OVERLAP. SIGMA BONDING IS STRONGER THAN PI BONDING. **BENT BONDING** IS INTERMEDIATE BETWEEN SIGMA AND PI BONDING, THE OVERLAP BEING NEITHER END-ON NOR SIDELONG. THIS MAKES THE OVERLAP LESS EFFICIENT THAN SIGMA OVERLAP, AND THE CYCLOPROPANE C-C BONDS WEAKER THAN NORMAL C-C SIGMA BONDS. THIS IS DESCRIBED AS **ANGLE STRAIN**.

The chemical properties of cyclopropane differ greatly from those of alkanes and cycloalkanes of the «normal size», five- and six-membered. This can be explained by the peculiarity of its structure. Cyclopropane as a flat molecule with the shape of a regular triangle exhibits a great steric strain. To avoid this, the C-C bonds are formed not by a head-on overlap of the carbon orbitals, as in alkanes, but by an overlap at a slight angle.



## Addition of hydrogen halides (hydrohalogenation)

Alkenes add hydrogen halides HX to yield alkyl halides. At first a proton interacts with electrons of  $\pi$  bond forming a  $\pi$ -complex. Then a proton forms a new C-H bond with one of the double-bond carbon of a substrate. Because this bond uses both  $\pi$  electrons, the other carbon atom becomes positively charged. An obtained carbocation is called a  $\sigma$ -complex. This is a slow step of the reaction. It is an extremely reactive electrophile that can accept an electron pair from a nucleophilic part of the reagent ( $X^-$ ) to form a new C-X bond. The second, fast step completes the reaction thus resulting in a neutral addition product. This sequence of transformations describes a mechanism of the electrophilic addition reaction. But if the alkene is unsymmetric two products are possible to be obtained. In practice, however, one product usually predominates. The addition of HCl to propene, for example, could lead to either 1-chloropropane and 2-chloropropane. The main product, however, 2-chloropropane.

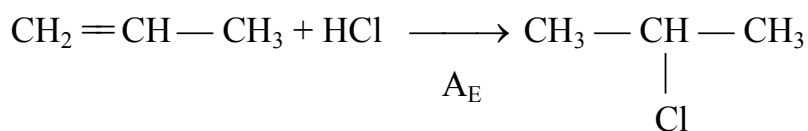

After studying a number of such reactions, the Russian chemist Markovnikov proposed (in 1869) what has become known as the **Markovnikov's rule**:

**In the addition of HX to an unsymmetrical alkene,  
the H atom adds to the carbon atom of the double bond that already  
has the greater number of hydrogen atoms.**

Much later, a rational explanation for the Markovnikov's rule has been given in terms of the modern chemical theory. The **first** approach consists in the distribution of partial charges in a non-reacting alkene molecule. For example, the +I effect of the methyl group in propene leads to the appearance of a partial negative charge on the C-1 atom. This carbon will be attacked first by an electrophile in the static state. The **second** approach to explain Markovnikov's rule involves carbocation stability.

Propene might form either a carbocation with two alkyl substituents (a secondary ion), or a carbocation with one alkyl substituent (a primary ion): alkyl carbocations greatly differ in their stability. Carbocations have a planar configuration where a charged carbon is  $sp^2$  hybridized. Alkyl substituents delocalize the positive charge due to their +I effect.

Thus, the more alkyl groups are attached to the cationic site, the more electron density shifts toward the charge and the more the cation is stabilized.

The order of stability of carbocations is tertiary > secondary > primary > methyl, i. e.  $\text{R}_3\text{C}^+ > \text{R}_2\text{CH}^+ > \text{RCH}_2^+ > \text{CH}_3^+$ .



## Modern statement of Markovnikov's rule:

**In the ionic addition of an unsymmetrical reagent to a double bond, the positive portion of the adding reagent attaches itself to a carbon atom of the double bond so as to yield the more stable carbocation as an intermediate.**

### Addition of water (hydration)

This reaction is one of the most important reactions in biological transformation of unsaturated compounds. Because of very low water acidity, this reaction requires a strong acid catalyst.

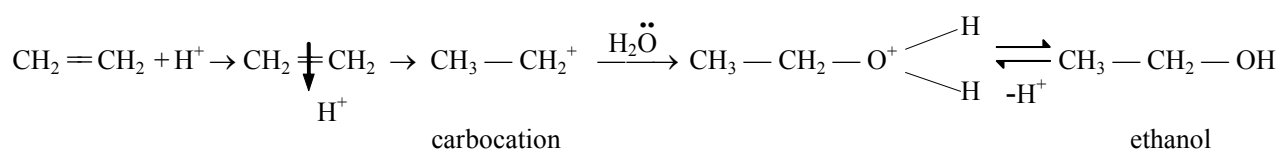

A reaction mechanism is similar to that of HBr addition. At first it involves protonation of the double bond. Then a  $\sigma$ -complex is slowly formed. And water as a nucleophile rapidly attacks a carbocation to yield a protonated alcohol. Finally loss of the proton from the protonated alcohol is a fast step to obtain a neutral product and to regenerate the catalyst.

### Addition of halogens (halogenation)

Alkenes add chlorine and bromine, even at room temperature or below. The addition reaction of bromine is used as a simple visual test for the presence of a double bond by decolouration of a brown-coloured bromine solution. This reaction also belongs to electrophilic addition though bromine is a non-polar reagent. However, the bromine molecule easily becomes polar in the polar media, for example as  $\text{Br}^{\delta+}-\text{Br}^{\delta-}$  in water solution.

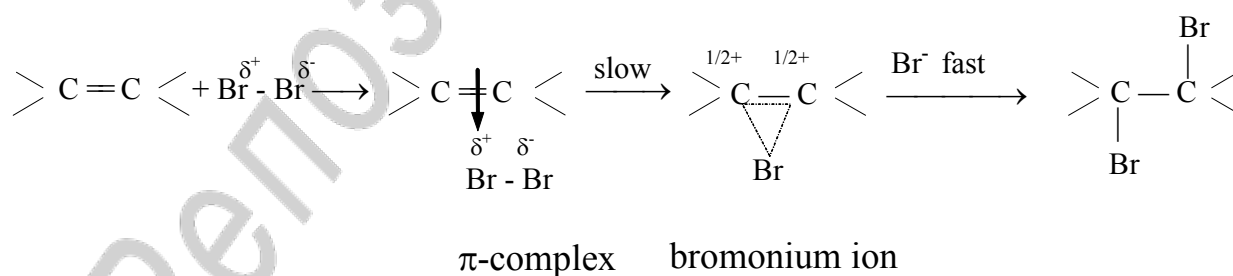

### Oxidation reaction

Alkenes are more easily oxidized than alkanes. The most employed chemical oxidizing agents are potassium permanganate, peroxides, and ozone. Potassium permanganate reacts with unsaturated compounds at room temperature in a neutral or alkaline solution to form **glycols**, or 1,2-diols (compounds with two adjacent hydroxyl groups). That is why the reaction is widely used as a test to distinguish unsaturated

compounds from saturated ones. It is often called the Baeyer test (in Belarus and Russia it is known as the Wagner test).

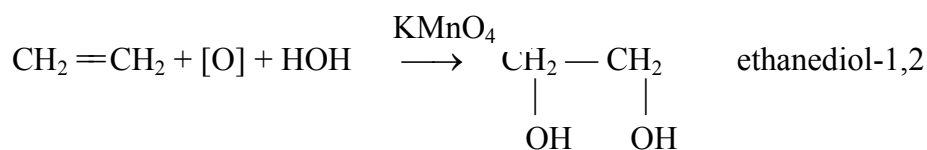

Since permanganate is able to oxidize other functional groups as well, this test is best used to complement other criteria of unsaturation.

### Addition Reactions to Dienes

Dienes undergo addition reactions in much the same manner as alkenes. One of the most substantial differences between conjugated dienes and alkenes is in their electrophilic reactions. The isolated dienes usually obtain a mixture of addition products in the reaction with equimolar amount of electrophilic reagent. One of these products is called **1,2-addition** product. The second product is called the **1,4-addition** product.

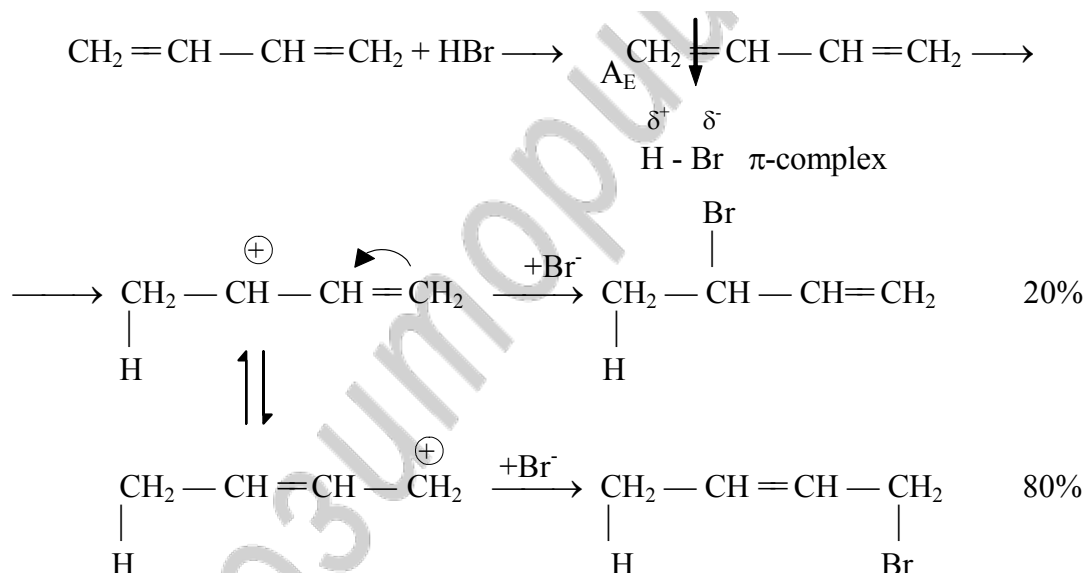

In the first, slow step two intermediate carbocations are possible: an allylic cation, which is stabilized by resonance, and a primary nonallylic cation. An allylic cation is more stable, because it has the conjugation system. In the second step the allylic cation reacts with the bromide ion, it can react either at the C-1 or C-3 cationic site to give a mixture of the 1,2- and 1,4-addition products. In general, 1,4-addition products are predominant when a reaction is performed at higher temperatures.

### Aromatic Hydrocarbons

The electron cloud of the benzene ring is susceptible to attack by electrophiles. The most important reactions of arenes and other aromatic compounds are the **electrophilic substitution** reactions in which an electrophile substitutes for one of the

hydrogen atoms. Using the proper conditions and reagents, it is possible to introduce an alkyl group -R in an **alkylation** reaction, a halogen atom in a **halogenation** reaction, a nitro group -NO<sub>2</sub> in a **nitration** reaction, a sulfo group -SO<sub>3</sub>H in a **sulfonation** reaction. To understand why electrophiles react by substitution instead of addition, let us consider a reaction mechanism.

An initial step in the reaction electrophile attacks the  $\pi$ -electron system of the benzene ring. Aromatic hydrocarbons are much less reactive than alkenes and a catalyst is always needed. A catalyst makes the reagent molecule more electrophilic. The electrophile bonds to one carbon of the benzene ring. It uses two of the  $\pi$  electrons from the aromatic cloud to form a  $\sigma$  bond with carbon. This carbon becomes sp<sup>3</sup>-hybridized. The resulting nonaromatic carbocation (a  $\sigma$  complex) is stabilized by resonance, i. e. the positive charge is delocalized over five carbons. This is a slow, rate-limiting step having high activation energy because of disruption of the aromatic  $\pi$  system. The reaction is completed by loss of a proton from the sp<sup>3</sup>-hybridized carbon in the second, fast step in which the aromatic system is regenerated. Thus the final result of the reaction is substitution.

Another possibility for stabilization of the  $\sigma$ -complex by addition of a nucleophile is unfavourable because of aromaticity loss.

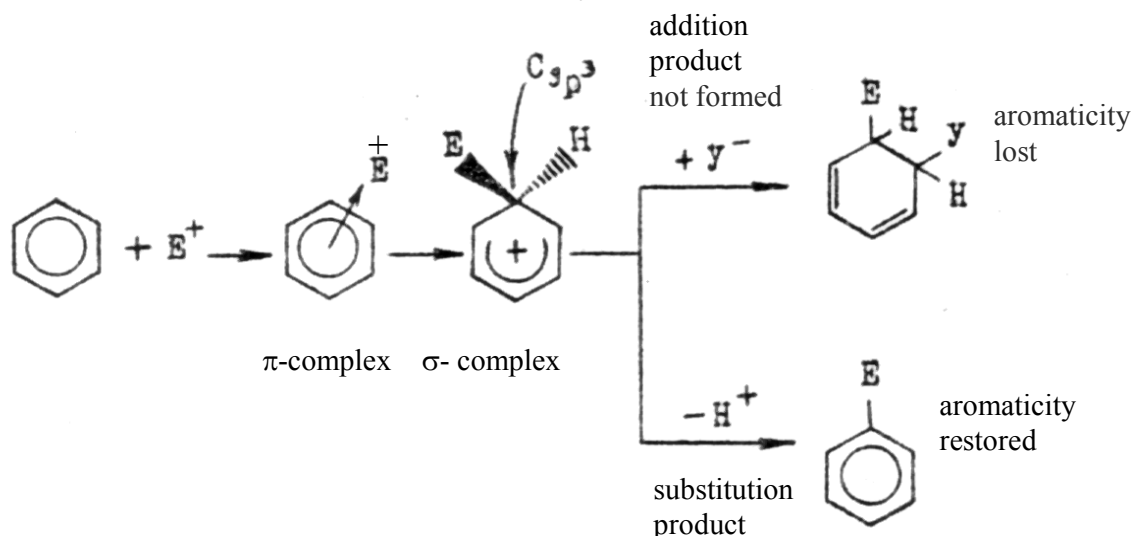

### Alkylation of benzene

This is one of the most useful of all aromatic substitution reactions, called after its discoverers the Friedel–Crafts reaction (1877). Alkyl halides serve as electrophilic reagents. In a classic variant of this reaction  $AlCl_3$  is used as a Lewis acid catalyst.

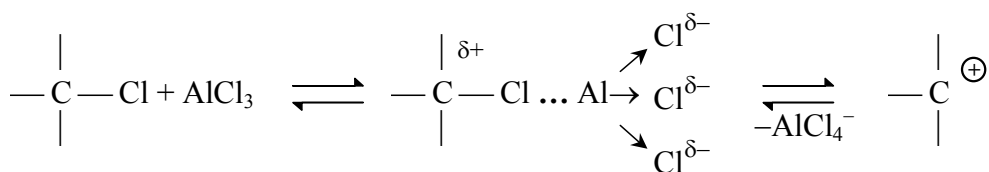

Aluminum chloride accepts an electron pair of the chlorine atom of alkyl chloride. The latter is turned to carbocation.

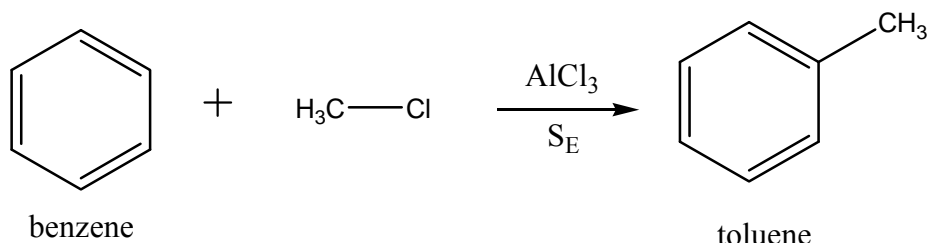

Carbocation acts as electrophile and attacks the benzene ring to form the cation. It then loses a proton to generate toluene. Alkenes and secondary or tertiary alcohols may be used as reagents for alkylation of the aromatic ring. In these cases electrophilic species (carbocations) are produced in the presence of an acid.

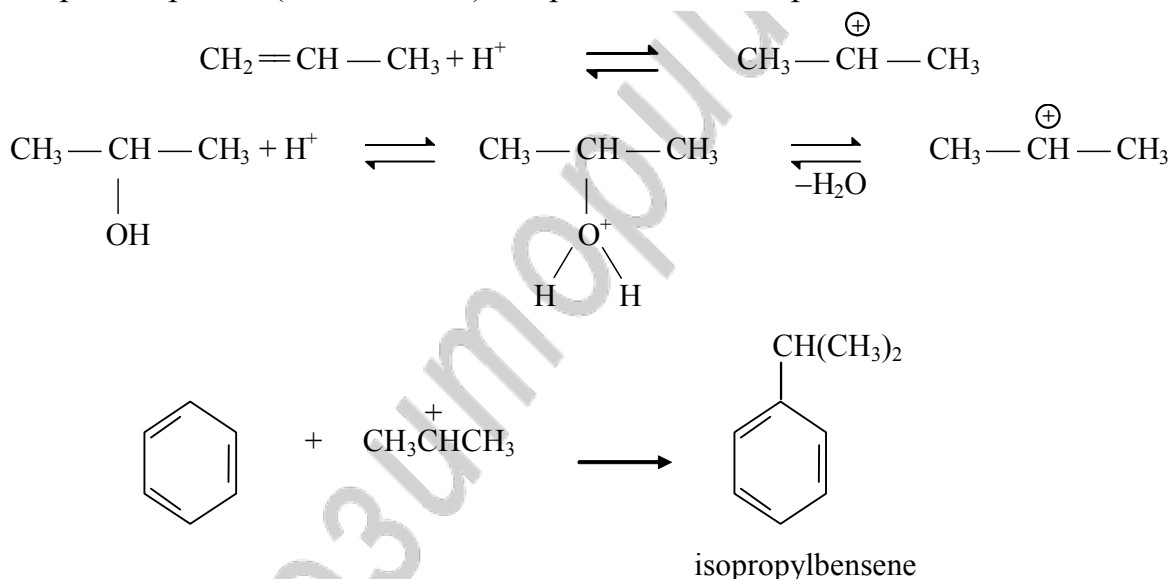

### Halogenation of benzene

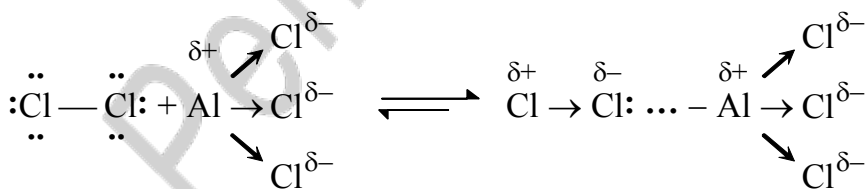

Chlorine or bromine reacts with benzene only in the presence of a Lewis acid such as FeCl<sub>3</sub>, FeBr<sub>3</sub> or AlCl<sub>3</sub>.

Note that only one atom of halogen is introduced in the benzene ring. The catalyst polarizes the chlorine molecule to form the strong electrophilic complex.

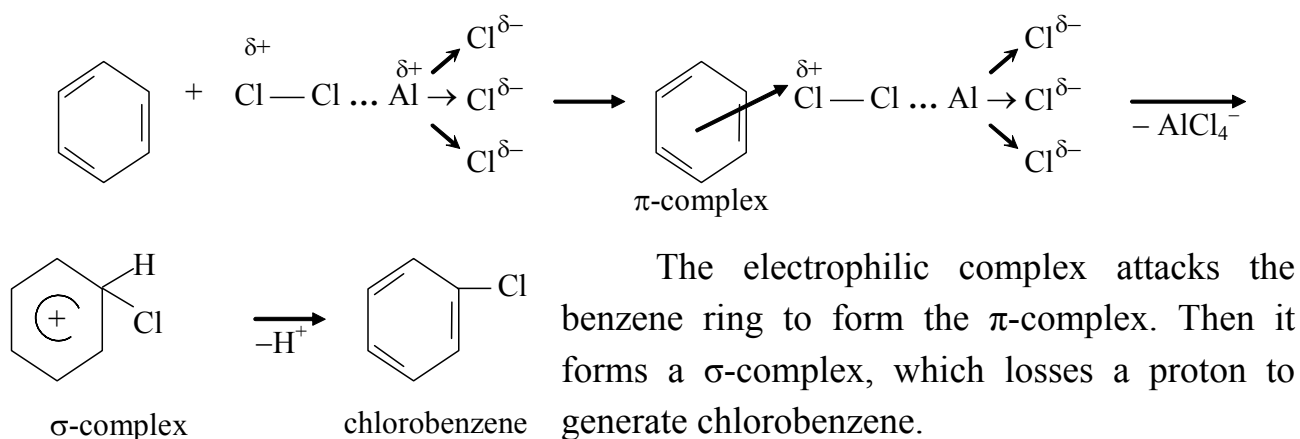

### Nitration of benzene

A mixture of concentrated nitric and sulfuric acids is used for introducing a nitro group into the aromatic ring. Sulfuric acid acts as a catalyst for producing the electrophilic **nitronium ion**,  $\text{NO}_2^+$  according to the equation:

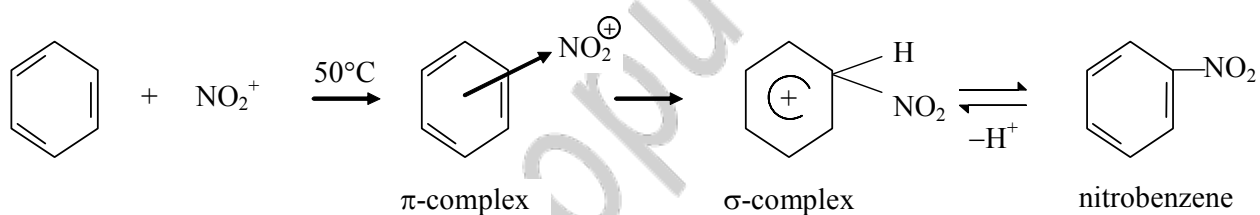
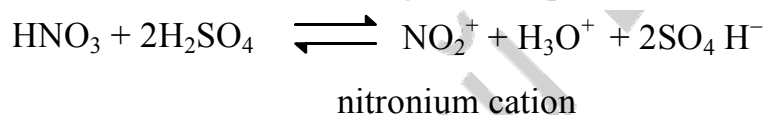

Nitronium cation attacks the benzene ring to form the  $\pi$ -complex and then  $\sigma$ -complex. The  $\sigma$ -complex loses a proton to generate nitrobenzene.

### Sulfonation of benzene

Incorporation of a sulfo group,  $-\text{SO}_3\text{H}$ , into the benzene ring occurs when an aromatic hydrocarbon is treated either with concentrated sulfuric acid or its mixture with sulfur trioxide.

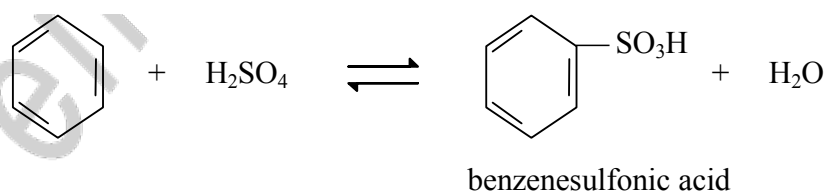

The electrophile is sulfur trioxide. The electronic density distribution in the sulfur trioxide molecule is the following.

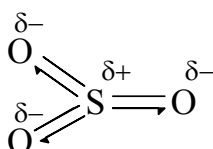

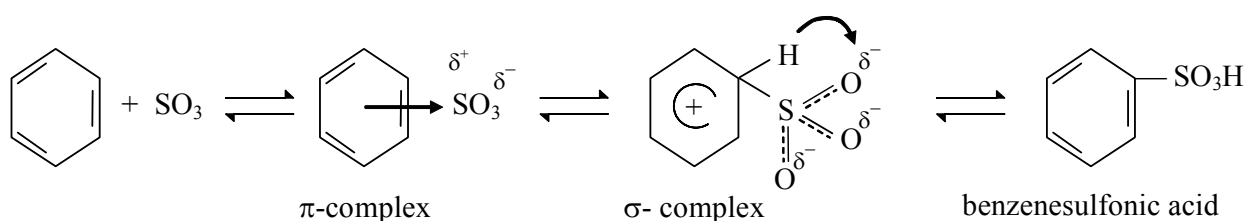

The sulfonation reaction is reversible; this means that the sulfogroup can be removed, for example, on heating benzenesulfonic acid with steam at 120–150 °C. Both sulfonation and nitration are important reactions because their products, nitro compounds and sulfonic acids, can be easily transformed into other classes of aromatic compounds such as phenols, amines, etc.

### Substituent Effects in Electrophilic Aromatic Substitution

Substituents already present in the benzene ring. They influence the electrophilic substitution. Firstly, they affect the reactivity of the ring and, secondly, they affect the orientation of substitution. The both effects are controlled by the cooperation of two factors: inductive and mesomeric effects of the substituent.

#### Reactivity of aromatic rings

Substituents attached to the benzene ring can be divided into electron-donating and electron-withdrawing ones. The electron-donating groups increase electron density on the ring; the electron-withdrawing groups, on the contrary, decrease it. Electron-donating groups facilitate an electrophilic attack on the benzene ring and they are referred to as **ring-activating** substituents. This substituents tend to incoming group into ortho- and para positions. Electron-withdrawing groups are naturally **ring-deactivating** ones. This substituents tend to the incoming group into meta positions. Many aromatic compounds that contain strong deactivating groups are not reactive at all. For example, benzoic acid, benzaldehyde, and some others, do not undergo the Friedel–Crafts alkylation reaction.

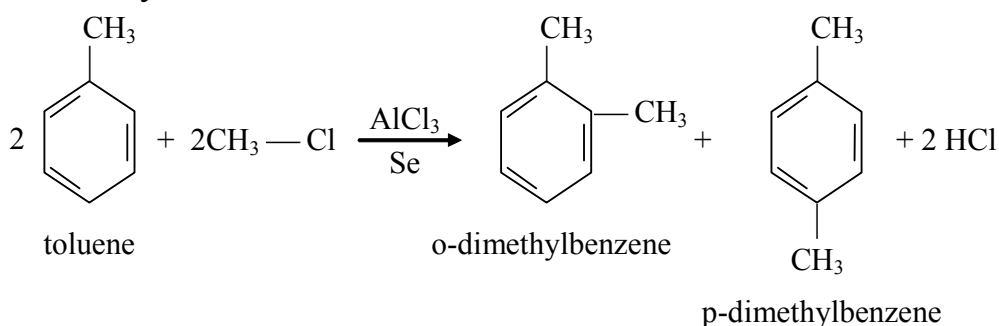

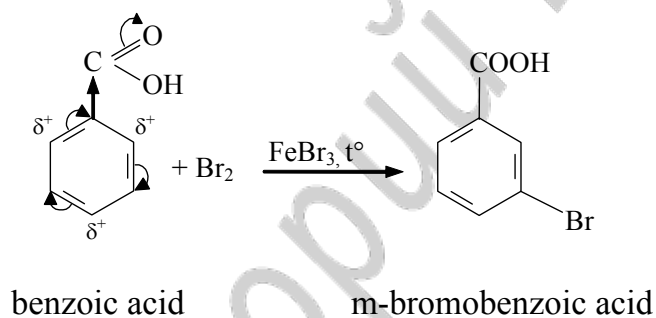
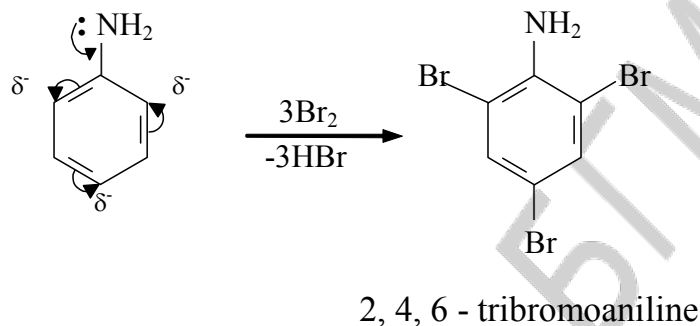
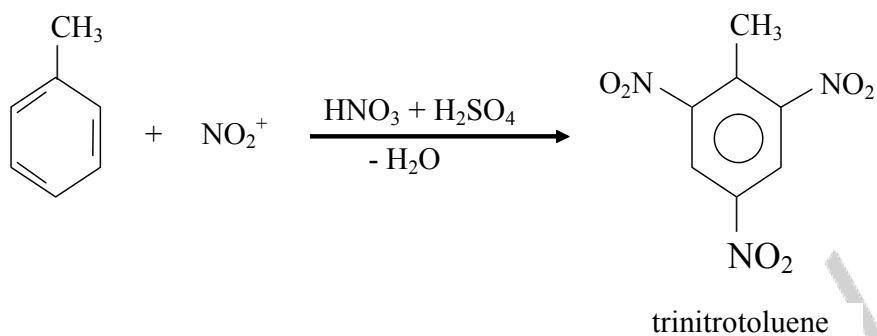

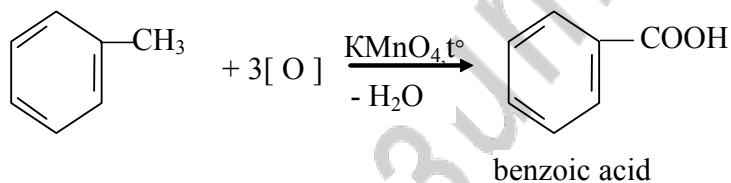

Benzene is quite inert to strong oxidizing agents. Benzene homologues, on the contrary, are readily oxidized by aqueous potassium permanganate or chromic acid on heating. The reaction involves attack of the oxidant on a C-H bond nearest to the benzene ring, thus converting an alkyl side-chain into a carboxyl group.

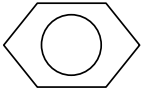
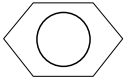
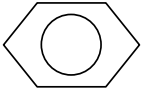
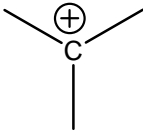

### Electrophilic substitution reactions in aromatic hydrocarbons

Reaction	Substrate	Reagent	Catalyst	Electrophile	Reaction product
1. Halogenation		Cl <sub>2</sub>	AlCl <sub>3</sub>	Cl <sup>+</sup>	 chlorobenzene
2. Nitration		HNO <sub>3</sub>	H <sub>2</sub> SO <sub>4</sub>	NO <sub>2</sub> <sup>+</sup>	 nitrobenzene

3. Sulfonation		SO <sub>3</sub> H <sub>2</sub> SO <sub>4</sub>	H <sub>2</sub> SO <sub>4</sub>	$\delta^+$ $\delta^-$ S O <sub>3</sub>	 — SO <sub>3</sub> H benzenesulfonic acid
4. Alkylation		R-Cl R-OH alkene	AlCl <sub>3</sub>		 — R alkylbenzene

Репозиторий БГМУ



## Nucleophilic Substitution Reactions: s<sub>n</sub>2 and s<sub>n</sub>1 mechanisms. Elimination Reactions

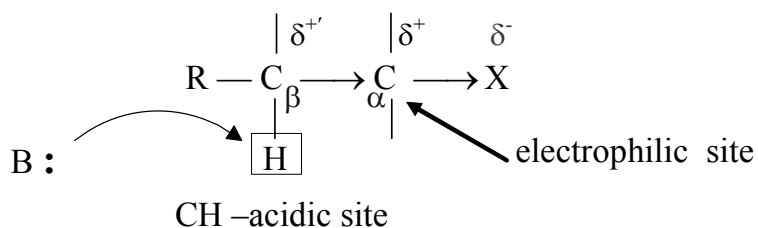

Nucleophilic substitution at saturated carbon is one of the simplest and, at the same time, the most important type of organic reactions. The different

compounds with an electrophilic site undergo to the nucleophilic substitution reactions. It may also be characterized as the **alkylation** reaction with reference to the nucleophile. Many reactions of biological importance represent nucleophilic substitution. In this reaction, one covalent bond is broken, and a new bond is formed. The reaction can be expressed in the following general equation.

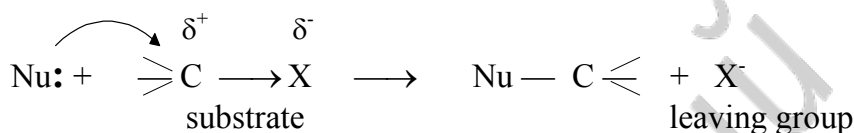

In the overall transformation, the C-X bond is ruptured in such a way that a pair of electrons be-

comes with a group X. A group X is called the **leaving group**. The nucleophile possesses an unshared (non-bonding) pair of electrons and uses them to form a new bond to the carbon.

### Nucleophiles and substrates

Compounds of different classes may be considered as nucleophiles. Both neutral molecules and anions can serve as nucleophilic reagents. The table lists some substrates and shows products that they form in the reaction of substitution.

Substrates	Leaving group
Haloalkanes	Cl <sup>-</sup> , Br <sup>-</sup> , I <sup>-</sup>
Alcohols	H <sub>2</sub> O
Ethers	ROH
Ethers of phosphoric acid	

Theoretically, the nucleophilic substitution reaction may be reversible because the leaving group is nucleophilic too. The main principle to force the reaction in the forward direction is to use the substrate with a good leaving group. In other words, the leaving group (an anion in most cases) must be more stable than the introducing

nucleophile. For this reason, the best leaving groups are the anions of strong acids, such as iodide, then bromide and chloride. It is evident that  $\text{HO}^-$  and  $\text{RO}^-$  belong to poor leaving groups.

Let us consider further examples of nucleophilic substitution. Two mechanisms of this reaction are known, **bimolecular** and **unimolecular** denoted by the symbols  $\text{S}_{\text{N}1}$  and  $\text{S}_{\text{N}2}$ , respectively.

The particular mechanism depends mainly on the structure of a substrate and the nature of a solvent used. The  $\text{S}_{\text{N}2}$  **mechanism** is a one-step process, exemplified below in the alkaline hydrolysis of ethyl bromide. In this reaction a nucleophilic hydroxide ion attacks the substrate (methyl bromide) and expels a bromide ion as the leaving group.

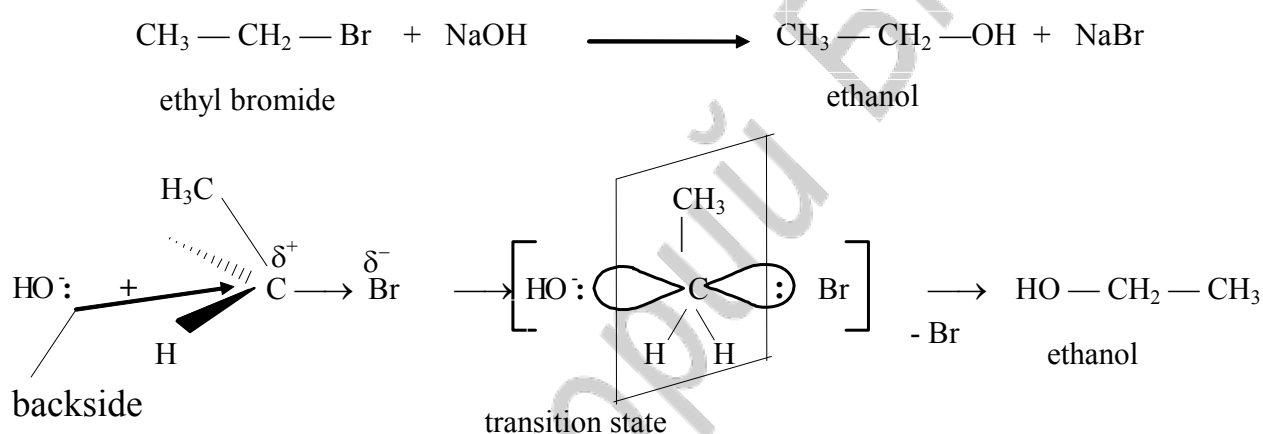

The hydroxide ion attacks the substrate from the backside of the C-Br bond. Then the transition state is formed, at which the nucleophile and the leaving group are partly bound to the carbon atom. The bromide ion leaves the carbon and the nucleophilic oxygen forms a covalent bond to the same atom simultaneously. In the  $\text{S}_{\text{N}2}$  symbol the number 2 indicates that the reaction is bimolecular, i. e. two molecules are involved in the only step of the reaction mechanism. The rate of such reactions depends on the concentration of both reactants and can be expressed as

$$\text{Rate} = k \cdot [\text{substrate}] \cdot [\text{nucleophile}]$$

Chiral compounds react by the  $\text{S}_{\text{N}2}$  mechanism with **inversion** of configuration as it is shown in the conversion of an *R* compound into an *S* enantiomer. Such a stereochemical result can be explained reasonably only by nucleophilic attack from the rear.

The  $\text{S}_{\text{N}1}$  **mechanism** is a two-step process. It will be considered on alkaline hydrolysis of a tertiary bromide. In the first, slow step the C-Br bond breaks heterolytically to form a carbocation. In the second, fast step the carbocation combines with the nucleophile. If the substrate is a chiral compound, the product consists of a mixture of

enantiomers. This is a result of a planar configuration of  $sp^2$ -hybridized carbon in the cation and subsequent nucleophilic attack from either side of the plane. Thus, the  $S_N1$  reactions occur with **racemization**.

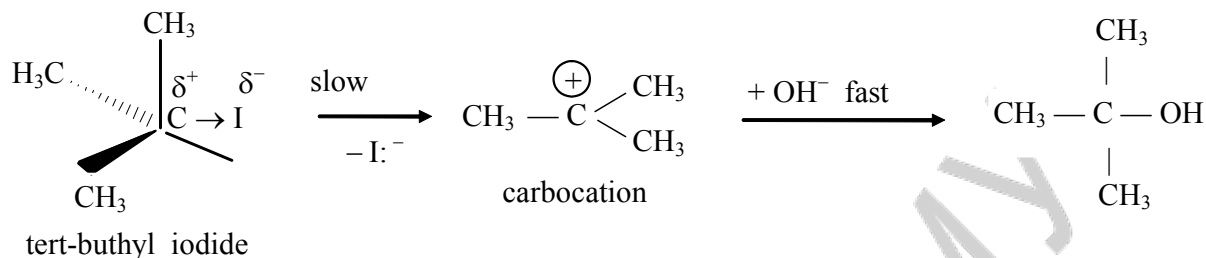

Like haloalkanes alcohols are potential substrates in reactions with nucleophilic reagents. However, one must keep in mind that the hydroxyl group is a bad leaving group. For example, the reaction of ethyl chloride preparing from ethanol and sodium chloride requires the presence of strong acid that converts the substrate into the ethyloxonium ion.

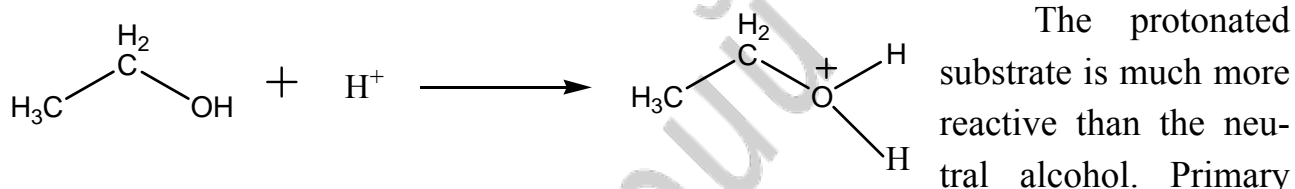

Primary alcohols undergo such substitution by an  $S_N2$  mechanism similarly to alkyl halides. The reaction proceeds slowly on heating an alcohol with concentrated hydrochloric acid for several hours. Tertiary alcohol on the contrary, easily reacts at room temperature to give the corresponding halide illustrated below. In these cases an  $S_N1$  mechanism is realized.

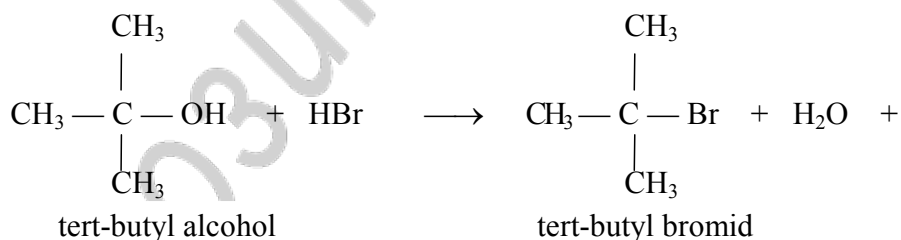

Now let us recall a  $\beta$ -acidic site at the  $\beta$ -carbon of an alkyl halide. A nucleophile with strong basic properties is capable not only of expelling a halide ion from a fragment  $-\text{CH}_2\text{CHX}-$ , but also of splitting off a proton from the  $\beta$ -carbon. Elimination of  $\text{HX}$ , or **dehydrohalogenation**, is observed in this case with the formation of a double bond.

Like in case of substitution, there are two mechanisms of the elimination reactions: unimolecular (or one-step, designated  $E1$ ) and bimolecular (or two-step,  $E2$ ). The simplified  $E2$  mechanism is represented above. Often elimination and substitu-

tion reactions occur simultaneously. Both paths of the competing reactions strongly depend on the structure of the substrate, nucleophile, and the reaction conditions.

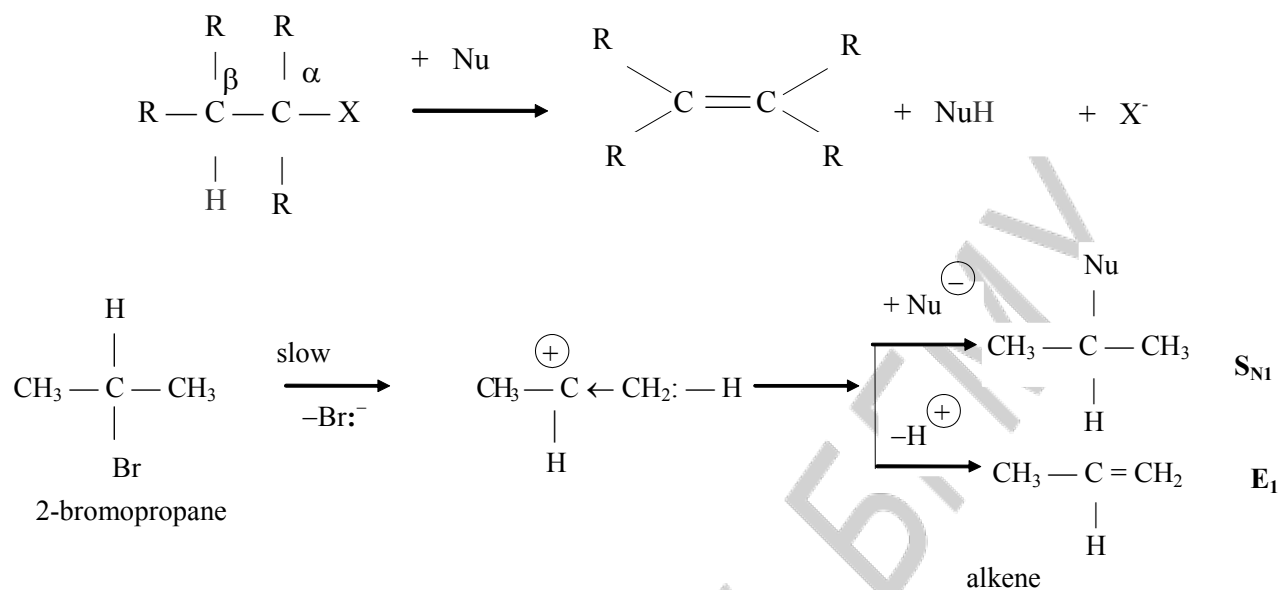

Different products may be obtained even with the same pair of reactants. For instance, treatment of alkyl halides with aqueous alkali results mainly in alcohol formation (the nucleophilic substitution reaction) and only a negligible amount of an alkene is formed. When ethanol, a less polar solvent, is used for the same reactants, alkene is a predominant product (the elimination reaction).

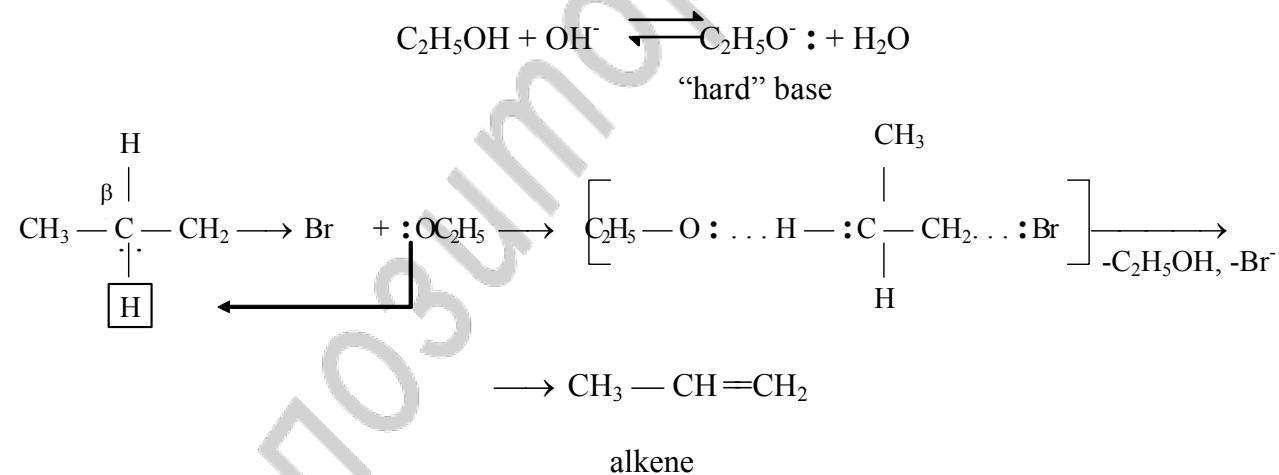

Unsymmetrical halides with non-terminal position of a halogen atom give a mixture of elimination products. The Russian chemist A. M. Zaytsev formulated (in 1875) a rule known as the **Zaytsev's rule**:

**When alternative elimination products from alkyl halides (or alcohols) is possible, the more highly substituted alkene predominates.**

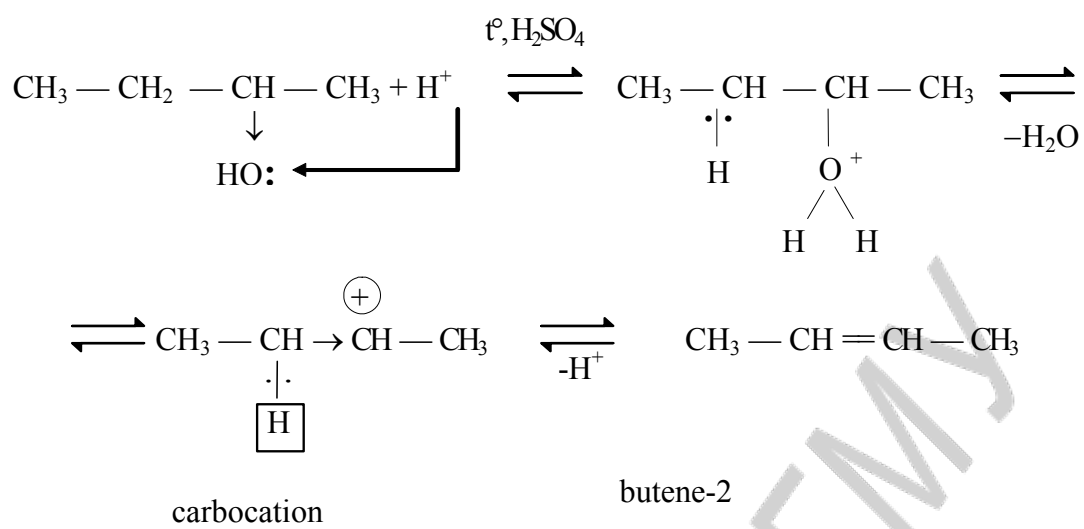

Репозиторий БГМУ

## Carbonyl Compounds

Aldehydes and ketones have the carbonyl group  $>C=O$  as a functional group and they are classified as carbonyl compounds. The carbonyl group is also a constituent of other functional groups generally expressed as  $-C(O)-Z$ , where Z is a substituent that has an atom with the unshared electron pair, i. e. halogen or oxygen-, nitrogen- or sulfur-containing groups.

Aldehydes are compounds in which the carbonyl group is bonded to at least one hydrogen. Ketones contain the carbonyl group bonded to two hydrocarbon residues. The general formulas of aldehydes and ketones are  $RCH=O$  and  $R-CO-R'$ , respectively.

**Carbonyl compounds are among the most important of all organic compounds, especially, in biological processes. It is sufficient to say that carbohydrates contain an carbonyl group.**

### Electronic Structure of the Carbonyl Group

**Both carbon and oxygen atoms are  $sp^2$ -hybridized in the carbonyl group. An orbital view of the bonding in carbon — oxygen double bonds.**



Just as in ethene or benzene, the carbon atom is joined to three other atoms. The carbon electrons are  $sp^2$  hybridized. Promotion gives:



Three  $sp^2$  hybrid orbitals are formed and they arrange themselves in space at the angles of  $120^\circ$  to each other. The remaining p orbital is at right to them.

### The oxygen atom

The oxygen electronic structure is  $1s^2 2s^2 2p_x^2 2p_y^1 2p_z^1$ . The 1s electrons are too deep inside the atom to be concerned with the bonding and so we'll ignore them from now on. Hybridization occurs in the oxygen as well. To see better this process we use "electrons-in-boxes".

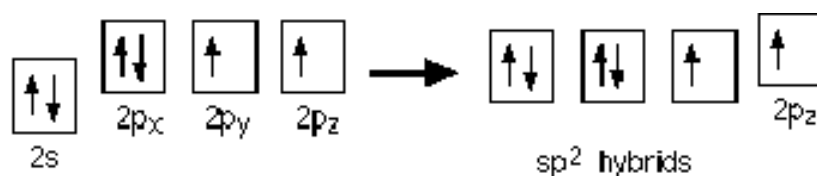

This time two of the  $sp^2$  hybrid orbitals contain lone pairs of electrons.

A lone pair of electrons is a pair of electrons at the bonding level which isn't be used to bond on to another atom.

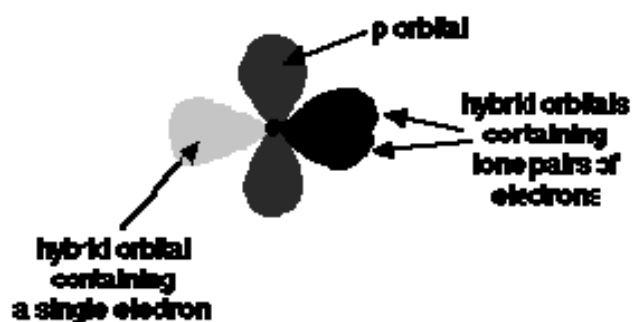

The carbon atom and oxygen atom then bond in much the same way as the two carbons do in ethene. In the next diagram, we are assuming that the carbon will be also bonded to two hydrogens to make methanal — but it could equally well bond to anything else.

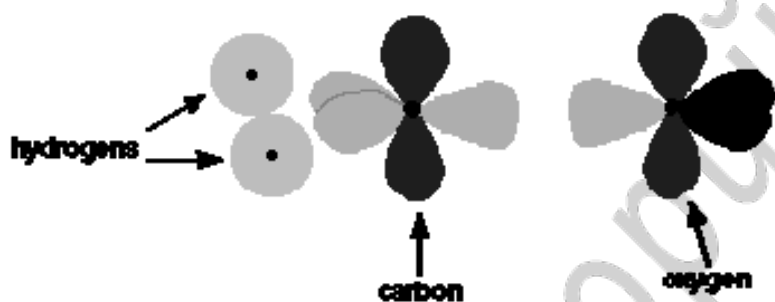

End-to-end overlap between the atomic orbitals pointing towards each other produce sigma bonds. Notice that the p orbitals are overlapping sideways.

This sideways overlap produces a  $\pi$  bond. So just like  $C=C$ ,  $C=O$  is made up of a sigma bond and a  $\pi$  bond. But electronic density of a  $\pi$  bond in a carbonyl group is more compact and polarized.

The distribution of electrons in the pi bond is heavily distorted towards the oxygen end of the bond, because oxygen is much more elec-

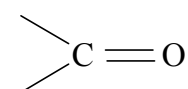
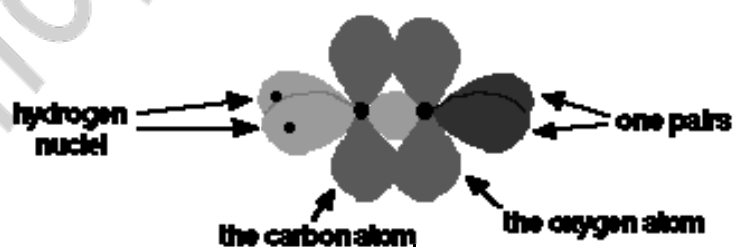

$l=0,121 \text{ nm}$   
 $E=710 \text{ kJ/mole}$

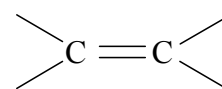

$l=0,134 \text{ nm}$   
 $E=620 \text{ kJ/mole}$

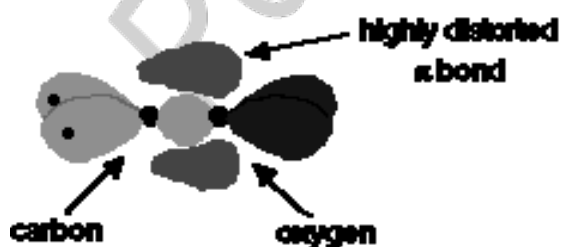

tronegative than carbon. The difference between the electronegativities of carbon and oxygen is large enough to make the  $C=O$  bond moderately polar. As a result, the carbonyl group is best described as a hybrid of the following resonance structures.

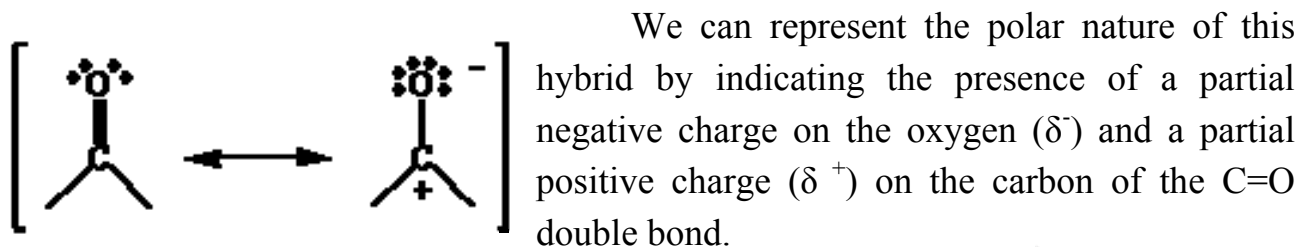

This distortion in the  $\pi$  bond causes major differences in the reactions of compounds containing carbon-oxygen double bonds like methanal compared with compounds containing carbon-carbon double bonds like ethene.

We can define the following reactivity centers in the aldehyde (ketone): electrophilic, basic and CH-acidic centers:

- the carbonyl carbon as an electrophilic site (literally, "lovers of electrons"), which can be attacked by nucleophiles (literally, "lovers of nuclei");

- an oxygen atom as a weak n-basic site that can be protonated with strong acids;

- a CH-acidic site is a weak acidic site that can be deprotonated with strong bases.

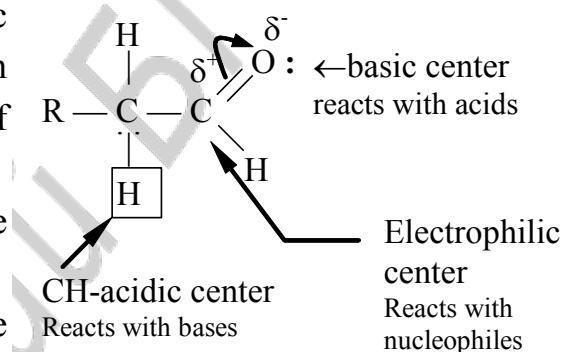

Additional reaction sites may arise when a double bond or an aromatic ring present in the hydrocarbon portion of a carbonyl compound. Aldehydes and ketones possess very weak acidity and basicity, therefore they can not form intermolecular hydrogen bonds. Carbonyl compounds are more volatile than the corresponding alcohols. Compare, for example, boiling points of propanal (49 °C), acetone (56 °C), and 1-propanol (97 °C).

### Nucleophilic Addition Reactions

Carbonyl compounds are susceptible to attack by nucleophiles. They undergo nucleophilic addition ( $A_N$ ) reactions rather than substitution because they have a very bad potential leaving group attached to the carbonyl carbon atom, i. e. anions  $H^-$  or  $R^-$ . A nucleophile that attacks the electrophilic carbon can be either negatively charged ( $Nu:^-$ ) or neutral ( $Nu:$ ). A hydroxide ion, alkoxide ions  $RO^-$ , a cyanide ion  $N=C^-$  and a hydride ion  $H^-$  are the examples of charged nucleophiles. To neutral nucleophiles belong water, alcohols, ammonia, and amines. A nucleophile approaches the carbon atom from a direction approximately perpendicular to the plane of the carbonyl group. At the first, slow step of the reaction, the nucleophile uses its electron pair to form a new C-Nu bond. This step is accompanied by carbon rehybridization from  $sp^2$  to  $sp^3$ . The important aspect of this step is the ability of the carbonyl oxygen atom to



accommodate the electron pair of the carbon-oxygen double bond. At the second, fast step, the oxygen accepts a proton. This happens because the oxygen atom is more basic; it carries a full negative charge, and it is an alkoxide ion. When the reaction is carried out in a protonic solvent such as water or alcohols, the reaction is completed by addition of a proton to the negatively charged oxygen.

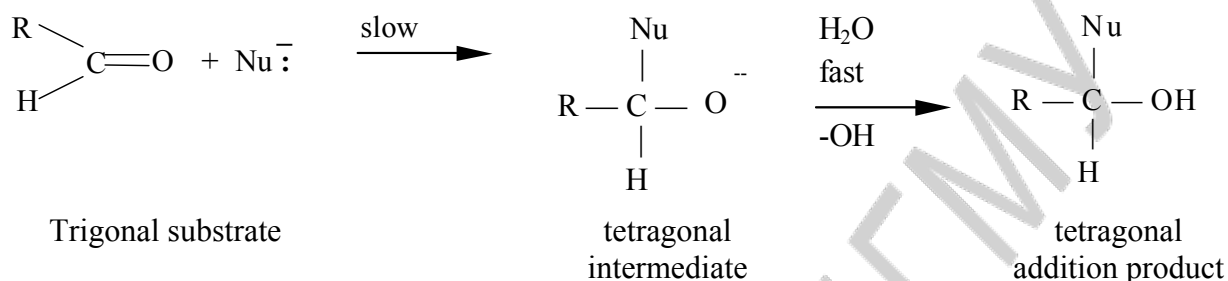

In general, aldehydes are more reactive than ketones towards nucleophiles because organic groups R' in ketones are both larger and more electron-donating than the hydrogen atom in aldehydes. Thus, the carbonyl carbon is more hindered in ketones, and the partial positive charge on this atom is also reduced. For the same reasons aromatic aldehydes and ketones are less reactive than their aliphatic counterparts.

Substituents with electron-donating effect (inductive or mesomeric) in the R portion of carbonyl compounds decrease reactivity in nucleophilic addition reactions. On the contrary, substituents with electron-withdrawing effect increase such reactivity.

Chemical reaction velocity depends on the effective positive charge value on the carbonyl carbon atom and space accessibility of the electrophilic center. Thus carbonyl compounds reactivity decrease in the following row.

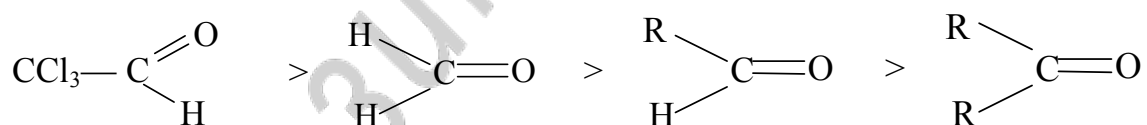

To increase reactivity of carbonyl compounds in the AN reactions are used 2 ways:

- 1) introduction of strong electronacceptors into the radical (for example, 2,2,2-trichloroethanal);
- 2) application of acid-catalyzed mechanism.

An electron pair of the carbonyl oxygen accepts a proton from the acid (or associates with a Lewis acid), producing an oxonium ion. An oxonium ion is the resulting protonated carbonyl compound and it is highly reactive toward a nucleophilic attack at the carbonyl carbon atom because it has a full positive charge on the carbon.

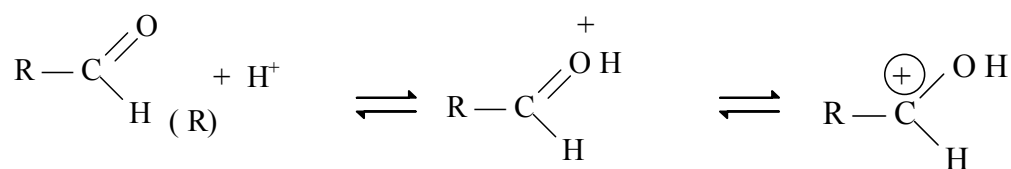

This step is reversible because carbocation is unstable.

### Examples of Nucleophilic Addition reactions of aldehydes and ketones the addition of water

Dissolving aldehyde such as acetaldehyde in water causes the establishment of an equilibrium between the aldehyde and its hydrate. This is 1,1-diol, called a gem-diol.

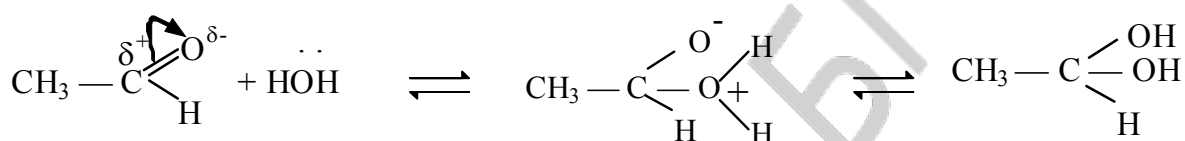

At the first step, water attacks carbonyl carbon. In two steps a proton is lost from the positive oxygen atom and a proton is gained at the negative oxygen atom.

The addition takes place much more rapidly in the presence of small amounts of acids or bases than it does in pure water. The important factor here in increasing the rate is the greater nucleophilicity of the hydroxide ion when compared to water. The equilibrium for the addition of water to most ketones is unfavorable, whereas some aldehydes (e.g., formaldehyde) exist primarily as the gem-diol in aqueous solution.

It is not possible to isolate most gem-diols from the aqueous solutions in which they are formed. Compounds with strong electron-withdrawing groups attached to the carbonyl group can form stable gem-diols, for example chloral hydrate.

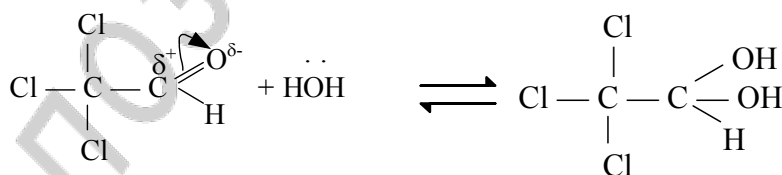

### The addition of alcohols

Dissolving aldehyde in alcohol causes the establishment of equilibrium between these two compounds and a new compound called a hemiacetal.

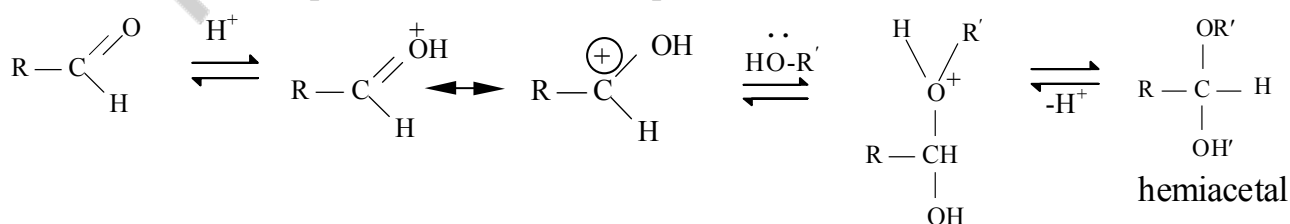

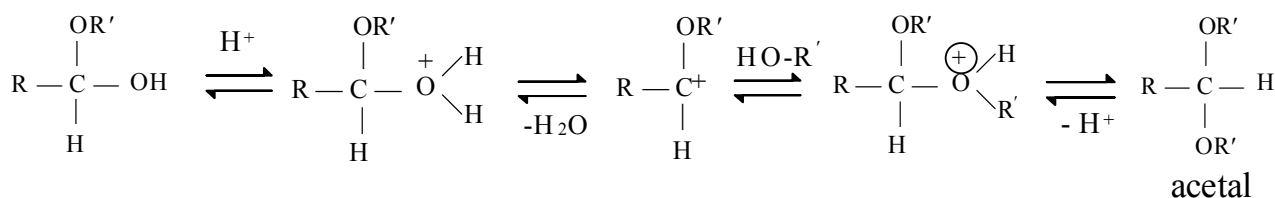

The essential structural features of hemiacetal are an  $-\text{OH}$  and  $-\text{OR}$  group attached to the same carbon atom. And since this carbon came from aldehyde, the C also has one H atom attached to it. Most open-chain hemiacetals are not sufficiently stable to allow their isolation.

Cyclic hemiacetals with 5- or 6-membered rings, however, are usually much more stable.

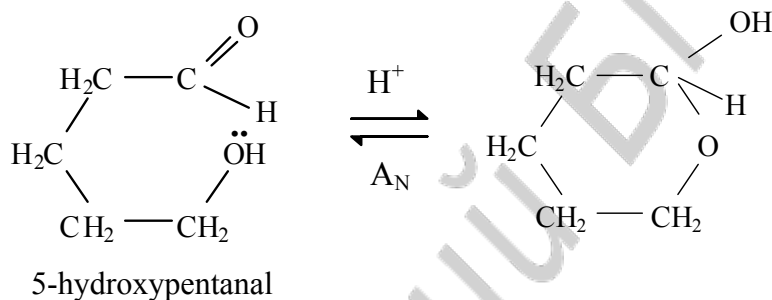

Most simple sugars exist primarily in a cyclic hemiacetal form. Glucose is an example.

### Reaction with amines

Aldehydes and ketones react with primary amines to form imines. Such N-substituted imines are also called Schiff bases. Imines are important in many biochemical reactions because many enzymes use an  $-\text{NH}_2$  group of amino acid to react with aldehyde and ketone to form an imine linkage.

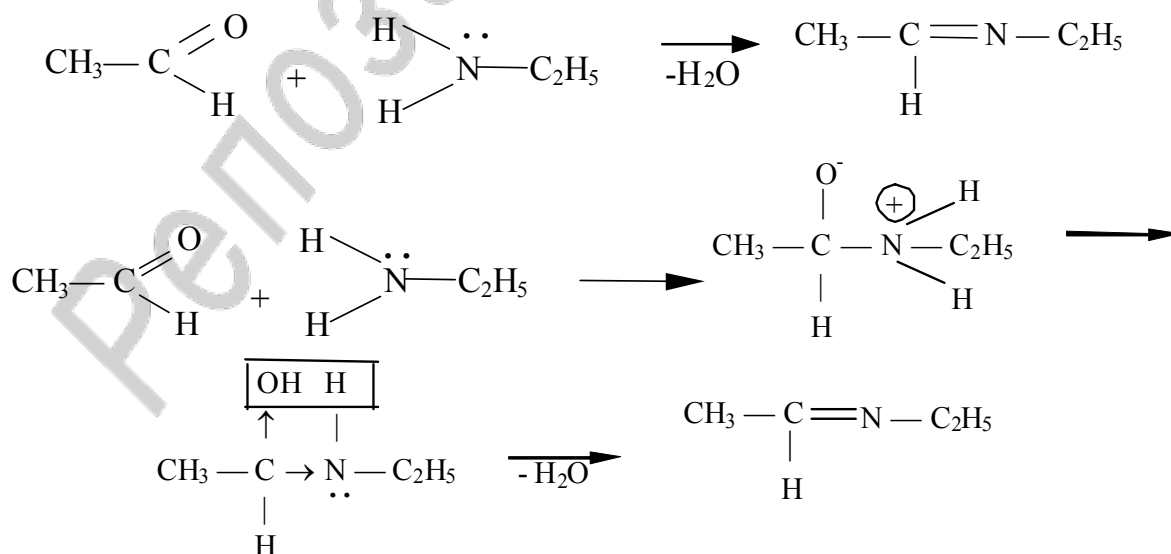

## Reduction reaction of aldehydes and ketones

Aldehydes and ketones react with a source of the hydride ( $\text{H}^-$ ) ion because the  $\text{H}^-$  ion is a Lewis base, or nucleophile, that attacks the  $^+$  end of the  $\text{C}=\text{O}$  bond. When this happens, the two valence electrons on the  $\text{H}^-$  ion form a covalent bond to the carbon atom. Since carbon is tetravalent, one pair of electrons in the  $\text{C}=\text{O}$  bond is displaced onto the oxygen to form an intermediate with a negative charge on the oxygen atom.

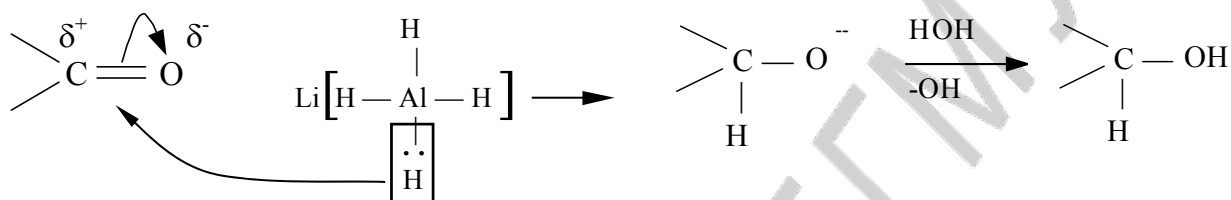

This alkoxide ion can then remove an  $\text{H}^+$  ion from water to form alcohol. Common sources of the  $\text{H}^-$  ion include lithium aluminum hydride ( $\text{LiAlH}_4$ ) and sodium borohydride ( $\text{NaBH}_4$ ).

Reduction reactions of the carbonyl compounds in vivo require the presence of NADH. For example, glyceraldehyde 3-phosphate is oxidized to a glyceric acid derivative in the presence of inorganic phosphate. This is one of the numerous steps in glycolysis.

Enzymic reduction of an oxo acid (pyruvic acid) to a hydroxyl acid (L-lactic acid) also require the presence of NADH.

## Oxidation reaction of aldehydes and ketones

Aldehydes are much more easily oxidized than ketones. Aldehydes are readily oxidized by strong oxidizing agents such as potassium permanganate, and they are also oxidized by such mild oxidizing agents as silver oxide.

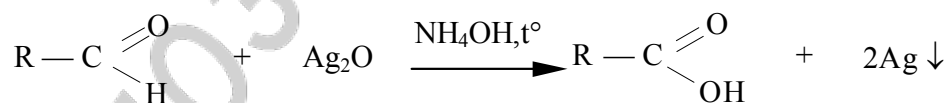

## Oxidation reactions of ketones. The Popov rule

Oxidation of ketones requires stronger oxidizing agents such as  $\text{HNO}_3$ ,  $\text{K}_2\text{Cr}_2\text{O}_7$  in  $\text{H}_2\text{SO}_4$  etc. as compared with aldehydes. This reaction is carried out with the break of carbon atom away from both sides of carbonyl group. The mixture of carboxylic acids is formed as a result of the reaction.

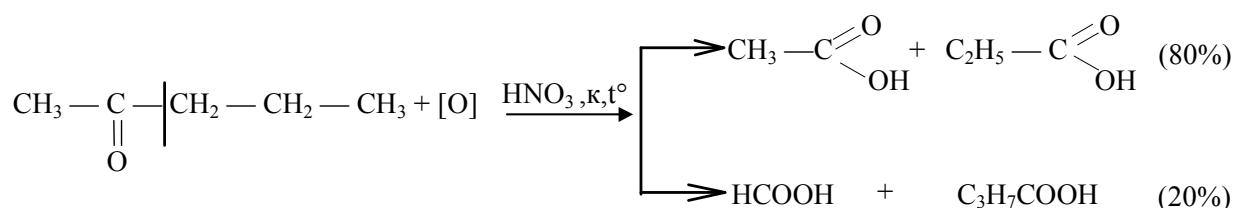

According to the Popov rule, carbon atom raw cracks in such a way that carbonyl group leaves with the smallest radical. This reaction can be used for the carbonyl location determination in the structure of a molecule (for example, fructose).

The **Cannizzaro reaction**, named after its discoverer Stanislao Cannizzaro, is a chemical reaction that involves the base-induced disproportionation of an aldehyde lacking a hydrogen atom in the alpha position. Cannizzaro first accomplished this transformation in 1853, when he obtained benzyl alcohol and benzoic acid from the treatment of benzaldehyde with potassium carbonate. Examples of aldehydes that can undergo a Cannizzaro reaction include aromatic aldehydes and formaldehyde.

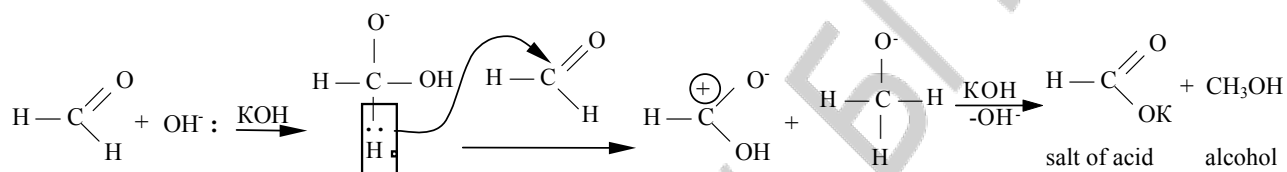

The first reaction step is nucleophilic addition of the base (for instance the hydroxy anion) to the carbonyl carbon of the aldehyde. The resulting alkoxide transfers a hydride,  $\text{H}^-$  to aldehyde. The hydridic character of the C-H is enhanced by the electron-donating character of the alpha oxygen anion. This hydride transfer simultaneously generates a hydroxyl anion and a carboxylate. Further evidence for the hydridic character of the Cannizzaro intermediate is provided by the formation of  $\text{H}_2$  by its reaction with water. Only aldehydes that cannot form an enolate ion undergo the Cannizzaro reaction. Under the basic conditions that facilitate the reaction, aldehydes that can form an enolate instead undergo aldol condensation.

### Aldol condensation reactions

These reactions are referred to a nucleophilic addition mechanism and occur when two aldehydes react with each other. Only aldehydes with a CH-acidic center of the  $\alpha$ -carbon atom interact in this reaction. Reactions are carried out in vitro in the presence of strong aqueous alkali solution, in vivo — as enzymic oxidation. In presence of alkali one aldehyde molecule turns into carbanion, which is nucleophilic and reacts with another aldehyde molecule.

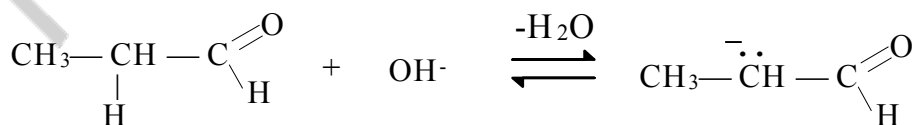

And then reaction is carried out on the typical AN mechanism:

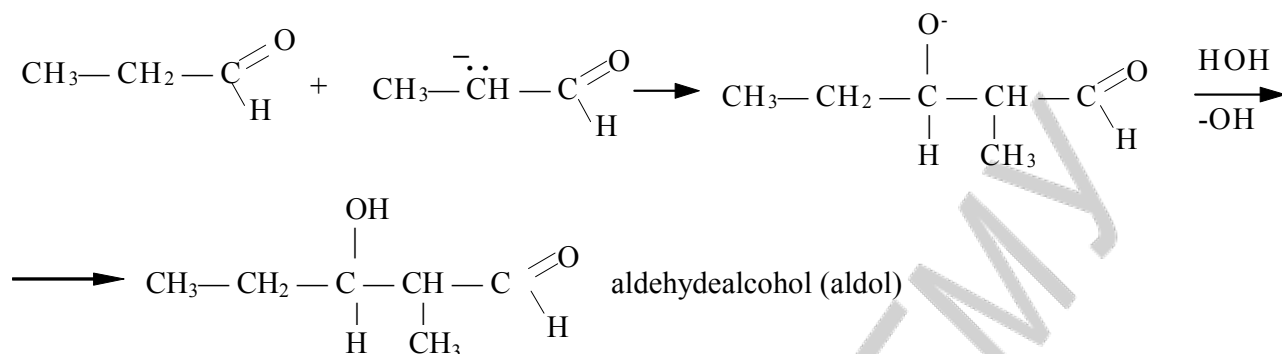

Using this reaction A. Butlerov pioneered to find of the sweetener in vitro. Due to this mechanism but with enzymes participation de novo monosaccharides and sialic acids synthesis takes place.

**Oxidation reactions are qualitative reactions** on the aldehyde group. Aldehydes are oxidized by oxygen and mild oxidizing agents such as metals oxides and hydroxides in the basic medium, when heated.

**The Tollen's Test** or the silver mirror reaction is a qualitative test for aldehydes when aldehydes are oxidized by  $\text{Ag}(\text{NH}_3)_2\text{OH}$  solution to corresponding acids and reduce Ag deposit on the sides of the test-tube as the mirror film. This test is an efficient but an expensive way to make acids from aldehydes.

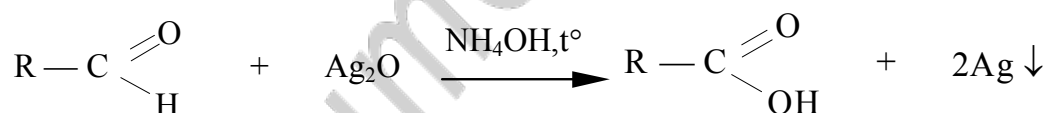

**Trommer Reaction.** Oxidation reactions of aldehydes with makeup Copper II hydroxide solution  $[\text{Cu}(\text{OH})_2]$  when heated.

Rick-red sediment of Copper I oxide is formed as a result of reaction.

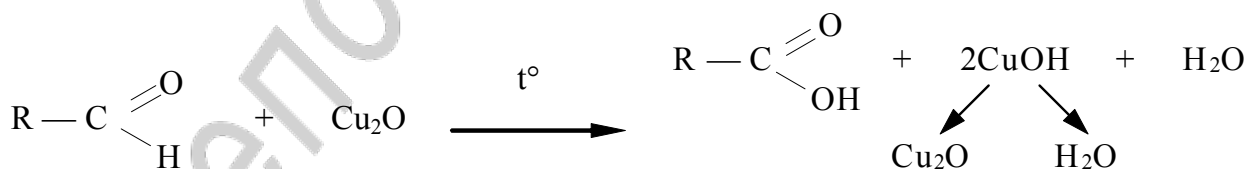

**Reaction with acid fuchsin.** This qualitative reaction of aldehydes is referred to  $A_N$  reactions. Non-colour acid fuchsin solution reacts with aldehydes forming the crimson color product.

### The haloform reaction

In the presence of bases, aldehydes and ketones, that have  $\alpha$ -hydrogen atoms, readily react with halogens to form  $\alpha$ -halogeno products. Thus under basic condi-

tions, halogenation of a methyl ketone often leads to carbon-carbon bond cleavage. This is called the haloform reaction because chloroform, bromoform, or iodoform is one of the products. The examples of haloform reactions are the following.

A qualitative iodoform reaction on the acetone and ketone bodies ( $\beta$ -hydroxybutyric,  $\beta$ -ketobutyric acids, acetone). In this reaction mobile hydrogen of the  $\alpha$ -carbon is substituted for halogen when reacts with alkaline iodine solution and following splitting of halogen derivatives.

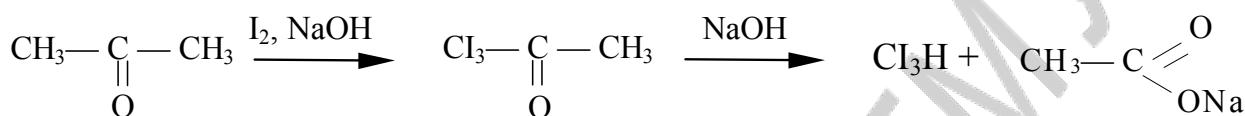

A reaction can be used for qualitative acetone determination in urine, which is appearing during long famine, pancreatic [insular] diabetes and poisonings.

**Lacrimators** are phenacyl halides that have halogen instead hydrogen in CH-acidic center of aliphatic radical:

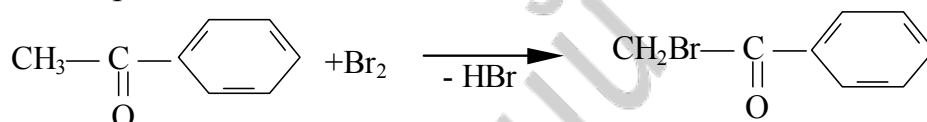

Halogen substituted acetophenone is a solid compound. In spray state it causes lacrimation. Therefore they are used as tear-gases called lacrimators.

**Formalin.** Aqueous 40 % formaldehyde solution is called formalin. It is used in medicine practice as a disinfectant (sanitizer) and anatomic preparations preservative since it possesses an ability to denature proteins. When long-term stored in the formaline white polymer sediment can be falled out which is called paraform (paraformaldehyde).

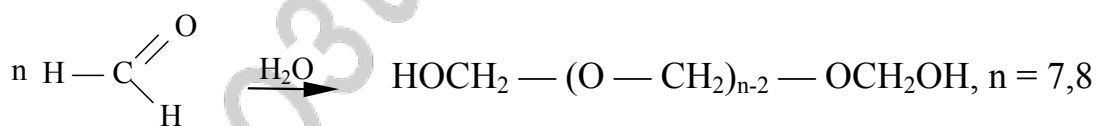

**Acetone** (also known as propanone, dimethyl ketone, 2-propanone, propan-2-one and  $\beta$ -ketopropane) is a colorless, mobile, flammable liquid. It is the simplest example of the ketones. Acetone is miscible with water, ethanol, ether, etc., and itself serves as an important solvent of organic compounds, for example fats, cellulose nitrates and acetates.

In addition to being manufactured as a chemical, acetone is also found in natural environment in a human body when  $\beta$ -ketobutyric acid carboxylation takes place. This process intensifies when diabetes takes place that leads to the increase of the acetone level in the blood, it's appearance in urine and in the expired air.

## Nucleophilic Substitution Reactions in Carboxylic Acids. Fatty acids, Structure, Nomenclature, Properties

Carboxylic acids are characterized by the carboxyl functional group COOH.

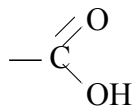

The carboxylic acids can be transformed into functional related carboxylic acid derivatives when hydroxyl group (OH) of a carboxyl group will be substituted by different substituents: esters, thioesters, amides, acyl halides, anhydrides and others. A number of heterofunctional compounds such as hydroacids, ketone acids, amino acids have a carboxyl group in their structure. Fatty acids and their related derivatives — esters, thioesters, lipids and others — take an important part in vital activity processes.

### Classification of carboxylic acids

The carboxylic acids are classified as aliphatic (saturated and unsaturated) and aromatic carboxyl acids.

#### The most important carboxylic acid

$\text{CH}_3\text{CH}_2\text{CH}_2\text{COOH}$	butyric acid
$\text{CH}_2=\text{CH}_2\text{COOH}$	acrylic acid
$\text{HOOCCH}_2\text{CH}_2\text{COOH}$	malonic acid
$\begin{array}{c} \text{COOH} \\   \\ \text{C}_6\text{H}_5 \end{array}$	benzoic acid
$\begin{array}{c} \text{COOH} \\   \\ \text{C}_5\text{H}_4\text{N} \end{array}$	nicotinic acid

### The structure and properties of carboxylic acids

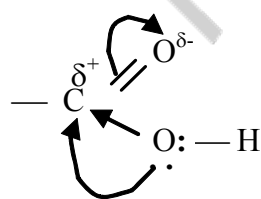

$p$ - $\pi$ -conjugation

The carboxylic group is composed of two functional groups — carbonyl (-CO) and hydroxyl (-OH) groups. The interaction of the hydroxyl and carbonyl group through inductive and

mezomeric effects leads to forming a new quality unit — the carboxylic group.







withdrawing substituent in the  $\alpha$ -position to the carboxylic group. Particularly the dibasic acids (for example, oxalic and malonic acids) are easily decarboxylated.

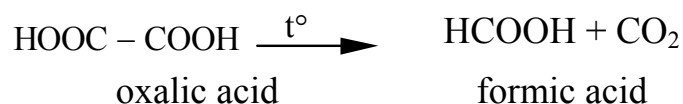

### The reaction of cyclic anhydride formation

While oxalic and malonic acids are easily decarboxylated, the warming up of succinic and glutaric acids leads to cyclic anhydride formation. This results in the formation of pentacyclic and hexacyclic compounds, which have the stable chair or semi-chair conformations.

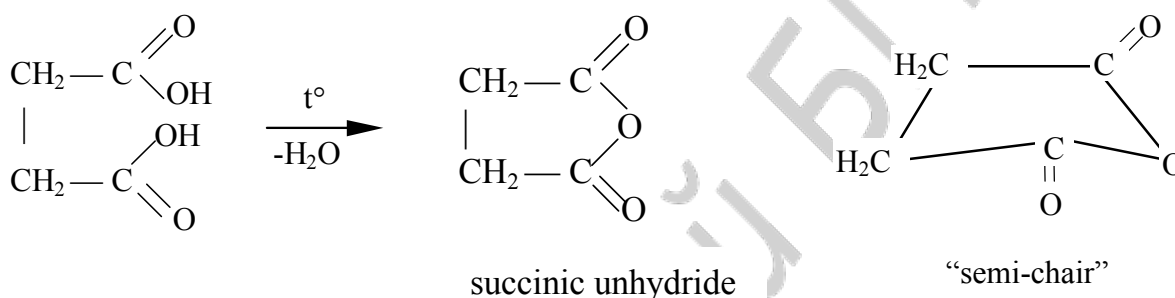

### Decarboxylation reactions in vivo

The decarboxylating reactions in biological systems proceed with a participation of **decarboxylase enzymes**. For example, amino acids are the source of biogenic amines after  $\text{CO}_2$  elimination:

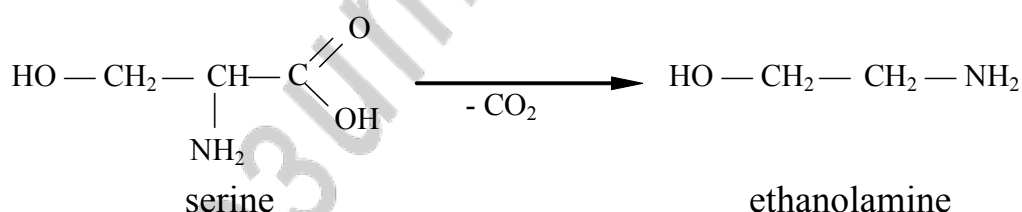

### Reactions with C-OH bond breaking

In such reactions the electrophilic center is used and as a result the OH-group is substituted by other substituents, and finally the functional carboxylic acid derivatives are formed. These reactions are called acylating because of the resulting compounds with the acyl residual of carboxyl acid ( $\text{RCO-}$ ). The acyl residuals of various acids have their common names like:

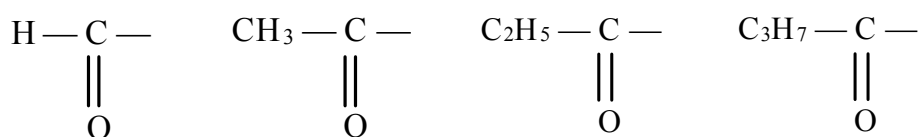

formyl

acetyl

propionyl

butyryl

The common formula of the carboxylic acid derivative:

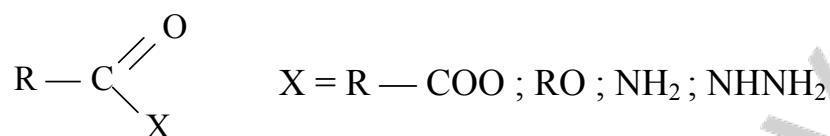

All the functional derivatives may be hydrolyzed until initial carboxylic acid is obtained. Preparation and hydrolysis of functional carboxylic acids derivatives are realized according to the S<sub>N</sub>-mechanism.

### Esterification of carboxylic acid

On heating a carboxylic acid with alcohol in the presence of an acid catalyst reversible ester formation occurs:

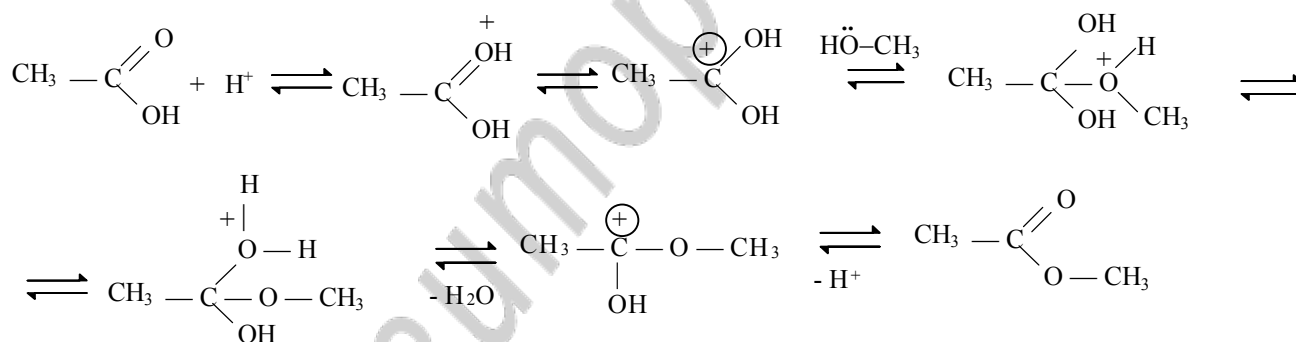
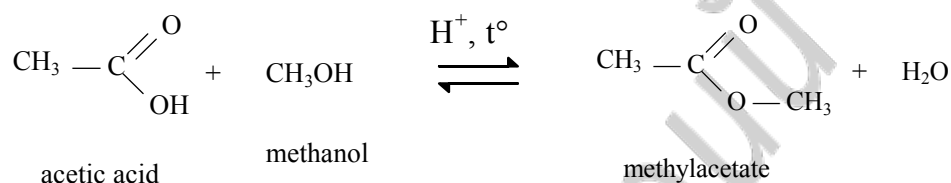

There are three main steps in a reaction mechanism. In the first step, protonation of a carboxylic acid increases the positive charge on the carboxyl carbon to give a resonance-stabilized cation. In the second, addition step alcohol (as a nucleophile) attacks the carbocation with the formation of a new C–O bond. Then, after proton migration, water is eliminated. Finally, loss of a proton gives the ester product and regenerates the acid catalyst. This is the nucleophilic substitution reaction.

Acidic hydrolysis of esters is a reverse reaction to the ester formation. Esters can also be hydrolyzed with alkalis:

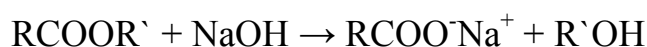

Alkaline hydrolysis is called **saponification** (from the Latin *sapo* — soap) because this type of reaction has been used and is used now to make soaps (alkali metal

salts of long-chain fatty acids) from fats. Saponification is an irreversible reaction, and at least one equivalent of an alkali is required.

### Acylation reactions with carboxylic acid derivatives

Numerous acid derivatives are known, but we will be concerned only with five of them: esters, amides, thioesters, anhydrides, and acyl halides. Esters and amides occur widely in nature; anhydrides and, especially, acyl halides are creatures of the laboratory chemists because of their high reactivity.

The reactions, involving common nucleophiles, such as water, alcohols, ammonia, and amines, are usually designated hydrolysis, alcoholysis, ammonolysis, and aminolysis, respectively. The transformations of this kind are often referred to acylation reactions, i.e. the acyl group is transferred from the group X in the acid derivative to nucleophile in the product. The term **acyl transfer** is used for such reactions in biochemistry.

Acylation reaction proceeds by a two-step addition-elimination pathway through a tetrahedral intermediate. Loss of a leaving group X regenerates the carbonyl group. The general reaction can be presented as follows:

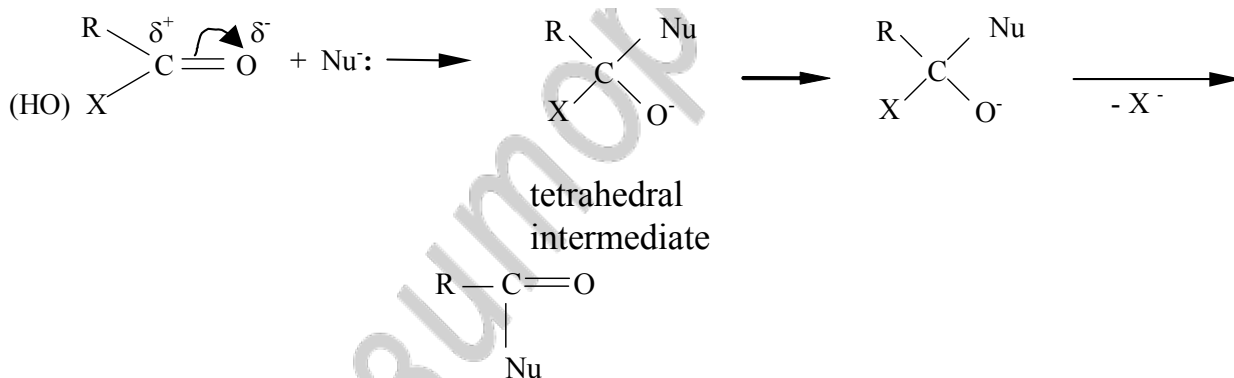

Relative reactivity of acid derivatives depends on stability of their leaving groups. The following anions are arranged in order of decreasing stability:

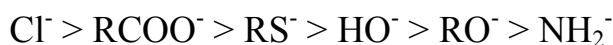

For this reason, the reactivity order in acylation reactions for carboxylic acids and their derivatives is as follows:



This means that it is easy to transform a **more reactive** acid derivative into a less reactive one. All acid derivatives can be hydrolyzed. Acyl halides and anhydrides undergo hydrolysis most readily, whereas esters and amides are hydrolyzed only on heating in the acidic or alkaline medium. Amides are acid derivatives that resist to hydrolysis the most. The reason is that the amino group is a very poor leaving group.

## Biological significance of esters

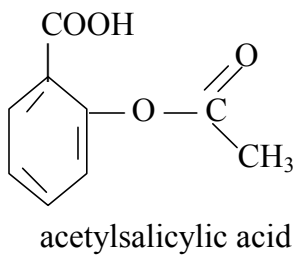

An ester bond is present in neurotransmitter acetylcholine, nucleotides, coenzymes, nucleic acids. Esters are fats and lipids in which formation multinuclear alcohols and the fatty acids take part. Fats are important spare energetical substrates and phospholipids. Other lipids are structural components of biological membranes. Many drugs are esters or amides from the chemical point of view. For example, aspirin (acetylsalicylic acid) is an ester manufactured from salicylic acid (2-hydroxy-benzoic acid). The phenolic hydroxyl group undergoes acetylation. Aspirin can be hydrolyzed under acidic or alkaline conditions. That is why we should always bear in mind the possibility of ester hydrolysis in the acidic medium of the stomach or in the alkaline medium of the intestines.

## Thioesters

Thioesters are more widely spread in nature of carboxylic acid derivatives. Such representative of thioesters is acetyl coenzyme A. Acetyl coenzyme A in vivo serves as a carrier of the acetyl group (for example, at synthesis of acetylcholine).

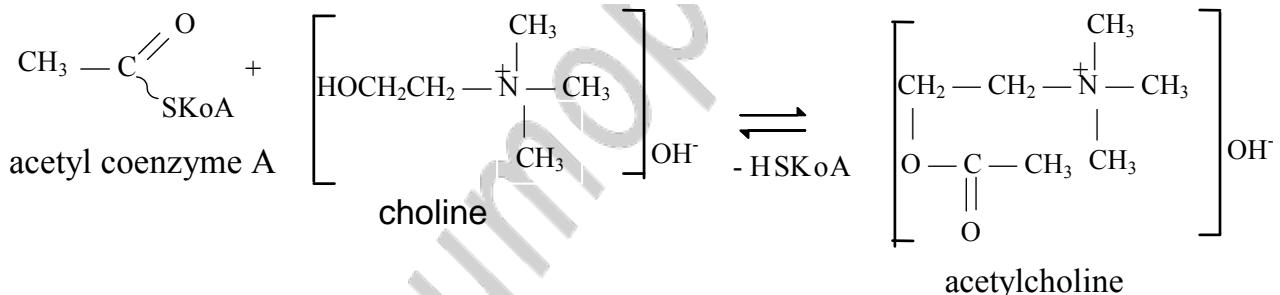

Synthesis of triacylglycerol goes with participation of acetyl coenzyme A. For example, one of the stage of this process.

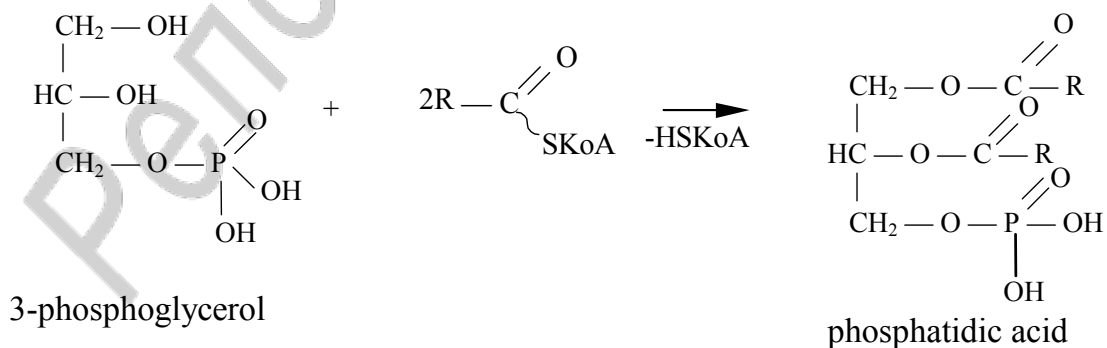

## The fatty acids

The fatty acids are mono carboxylic acids with a long carbon chain, containing usually even number of carbon atoms (from 6 to 24). The fatty acids can be saturated and unsaturated.

### Saturated acids

Symbol	Structure	Common name	Occurrence
C <sub>16:0</sub>	CH <sub>3</sub> (CH <sub>2</sub> ) <sub>14</sub> COOH	Palmitic	It is widespread in all animal fats and vegetable oils
C <sub>18:0</sub>	CH <sub>3</sub> (CH <sub>2</sub> ) <sub>16</sub> COOH	Stearic	The same
C <sub>20:0</sub>	CH <sub>3</sub> (CH <sub>2</sub> ) <sub>18</sub> COOH	Arachidic	In peanut oil

### Unsaturated acids

Symbol	Structure	Common name	$\omega$ -nomenclature	Occurrence
C <sub>18:1</sub>	C <sub>17</sub> H <sub>33</sub> COOH CH <sub>3</sub> (CH <sub>2</sub> ) <sub>7</sub> CH=CH(CH <sub>2</sub> ) <sub>7</sub> COOH	oleic	18:1 $\omega$ 9	The most widespread acid in all fats and oils
C <sub>18:2</sub>	C <sub>17</sub> H <sub>31</sub> COOH CH <sub>3</sub> (CH <sub>2</sub> ) <sub>4</sub> CH=CHCH <sub>2</sub> CH=CH(CH <sub>2</sub> ) <sub>7</sub> COOH	linoleic	18:2 $\omega$ 6	In corn, peanut, cotton and other vegetable oils
C <sub>18:3</sub>	C <sub>17</sub> H <sub>29</sub> COOH CH <sub>3</sub> CH <sub>2</sub> CH=CHCH <sub>2</sub> CH=CHCH <sub>2</sub> CH=CH(CH <sub>2</sub> ) <sub>7</sub> COOH	linolenic	18:3 $\omega$ 3	In linen oil, often accompanies to linoleic acid
C <sub>20:4</sub>	C <sub>19</sub> H <sub>31</sub> COOH CH <sub>3</sub> (CH <sub>2</sub> ) <sub>4</sub> (CH=CHCH <sub>2</sub> ) <sub>4</sub> CH <sub>2</sub> CH <sub>2</sub> COOH	arachidonic	20:4 $\omega$ 6	In peanut oil, in phospholipids and animals

Unsaturated highest fat acids can contain one, two, three and more double bonds.

The fatty acids are named either by the IUPAC system or by common names. The principles of IUPAC include indication of the number of carbon atoms, the configuration of the double bond (the common variant is cis), and the number of double bonds and their position which is numbered starting with the carboxyl group.

The  $\omega$ -nomenclature is the most convenient for indication of unsaturated fatty acids. According to its principles the structure of any unsaturated fatty acid may be expressed with three numbers:

- the number of carbon atoms;

- the number of double bonds;
- the number of carbon atoms between the double bond and the methyl group ( $\omega$ -carbon).

### Characteristics of a fatty acid structure

The natural fatty acids have the unbranched carbon chains. In conditions of physiologic pH the fatty acids are ionized. The melting points of unsaturated fatty acids are lower than in saturated acids with the similar number of carbon atoms. The chains of saturated fatty acids have a zigzag shape in which the carbon atoms are arranged in anti-butane conformation. In zigzag unsaturated fatty acids the conformation of long carbon chains is interrupted by fragments which have their substituents arranged in a planar setting (here  $sp^2$ -hybridization occurs). The naturally unsaturated acids have the cis-form conformation, which is less thermodynamically stable but allows more profitable compact packing of carbon-hydrogen radicals in lipids and cell membranes. The double bonds in poly-unsaturated fatty acids are not conjugated because they are separated by two sigma-bonds. The unsaturated fatty acids are also called **essential**; except oleic acid, they are not synthesized in vivo so they must be taken with food (for example, vegetable oil).



## Poly- And Heterofunctional Compounds

Very often biologically important organic compounds contain several functional groups. These groups can be identical or different. Polyfunctional compounds contain several identical functional groups. Polyfunctional compounds are classified into the following groups:

- dicarboxylic acids;
- polyhydroxyl alcohols;
- polyamins.

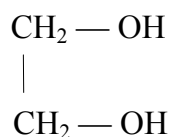

ethylene glycol

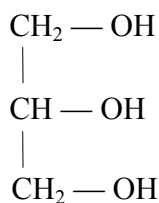

glycerol

For example, ethylene glycol and glycerol contain two and three hydroxyl groups, respectively. Dicarboxylic acids, such as oxalic and malonic contain two carboxylic groups.

Oxalic acid and oxalates are abundantly present in many plants, most notably fat hen (lamb's

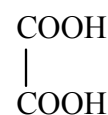

oxalic acid

quarters), sorrel. The affinity of divalent metal ions is sometimes reflected in their tendency to form insoluble precipitates. Thus in the body, oxalic acid also combines with metals ions such as Ca<sup>2+</sup>, Fe<sup>2+</sup>, and Mg<sup>2+</sup> to deposit crystals of the corresponding oxalates, which irritate the gut and kidneys. Because it binds vital nutrients such as calcium, long-term consumption of foods high in oxalic acid can be problematic.

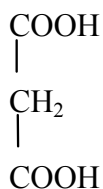

malonic acid

The calcium salt of malonic acid occurs in high concentrations in beetroot. It exists in its normal state as white crystals. Malonic acid is the archetypal example of a competitive inhibitor: it acts against succinate dehydrogenase in the respiratory electron transport chain.

**Heterofunctional** compounds involve different functional groups in the same molecule. A significant importance in living systems belongs to this compounds.

## Types of Heterofunctional Compounds

A hydroxyl, amino, oxo, and carboxyl groups are most widely found in heterofunctional compounds. A combination of different functional groups results in the formation of mixed classes of organic compounds. At the first approximation, the chemical behavior of heterofunctional compounds can be represented as a sum of separate monofunctional classe properties. For example, pyruvic acid contains oxo

and carboxyl groups. Therefore, this compound is characterized by the reaction of nucleophilic addition of the corresponding oxo group and nucleophilic substitution of the corresponding carboxyl group.

In various combinations of functional groups new properties appear. When the functional groups are close to each other their interaction is more sharply expressed. This may be illustrated if we compare acidic and electrophilic properties of some heterofunctional carboxylic acids. In the aliphatic series, all groups are electron-withdrawing substituents, therefore one group has an influence on another. Thus, lactic and pyruvic acids are stronger ( $pK_a$  3.9 and 2.4, respectively) than propanoic acid ( $pK_a$  4.9).

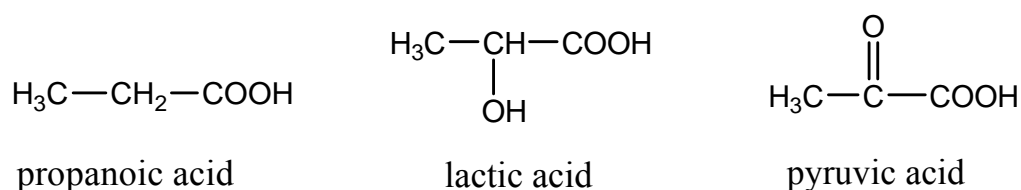

The hydroxyl group in lactic acid and the oxo group in pyruvic acid decrease an electron density, or increase  $\delta+$ , on the carboxylic carbon. On the other hand, the inductive effect of the carboxyl group results in a similar increase of  $\delta+$  on the atom C-2 in pyruvic acid. Both carbonyl carbons in pyruvic acid are stronger electrophilic sites as compared with monofunctional three-carbon analogues, i. e. acetone and propanoic acid. Therefore pyruvic acid reacts with nucleophiles more readily by both nucleophilic addition and nucleophilic substitution reactions.

### Interaction of different groups in heterofunctional compounds

Many functional groups can affect each other, especially if one of these groups is a carboxyl or carbonyl group. Two types of interaction are possible — intermolecular and intramolecular. The intramolecular interaction occurs when two functional groups occupy favourable positions for such a reaction. This reactions are possible for  $\gamma$ - and  $\delta$ -hydroxy- or amino acids. Such molecules take claw-shaped conformation to make a better contact of both functional groups. They undergo to internal esterification. The esterification reaction product of  $\gamma$ - and  $\delta$ -hydroxyacid is lactone.

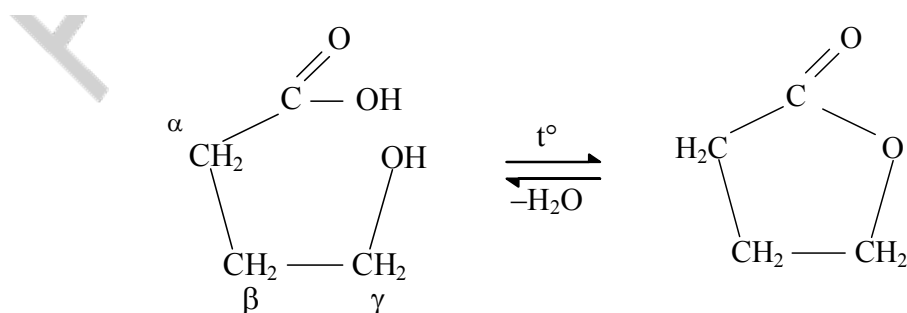

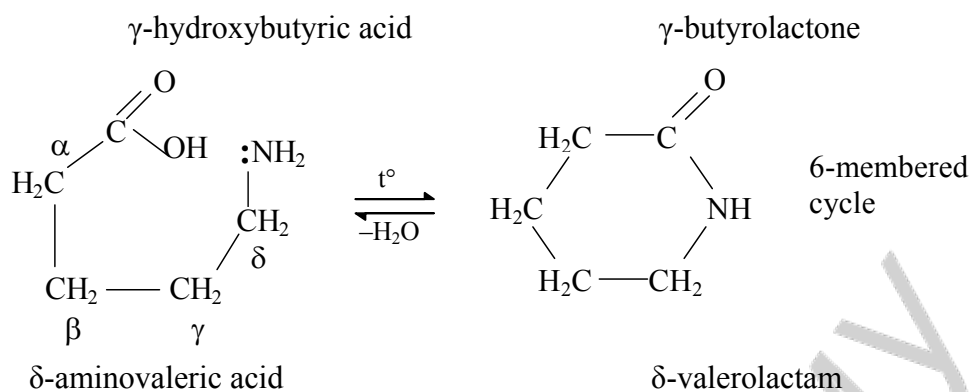

The esterification reaction product of  $\gamma$ - and  $\delta$ -amino acid is lactam. Cyclization occurs if a thermodynamically stable five- or six-membered cycle is formed. These reactions require heat. They are reversible.

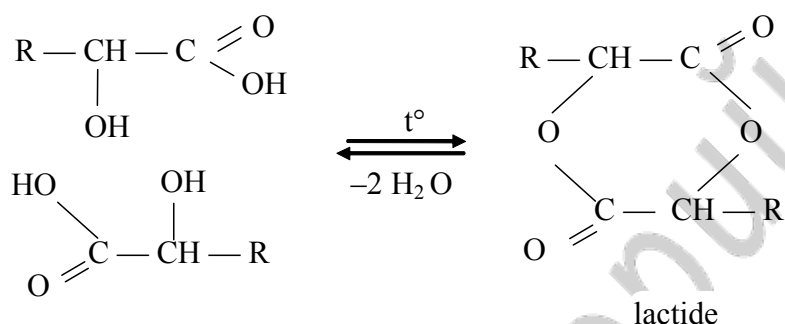

$\alpha$ -Hydroxy acids and  $\alpha$ -amino acids can react intramolecularly. Lactic acid, for example, undergoes intermolecular esterification on heating. A six-membered cyclic diester is formed. The name of such cyclic diesters is **lactides**.

In a similar manner  $\alpha$ -amino acids form on heating cyclic diamides called **diketopiperazines**. (Heterocycle piperazine has two nitrogen atoms in a six-membered cycle).

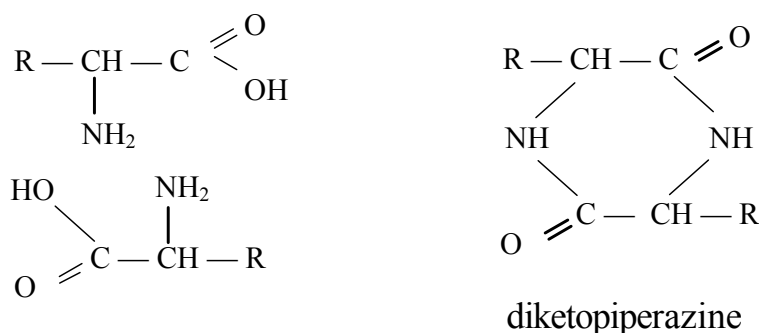

### Complexing properties

Heterofunctional compounds have the chelating ability. It is based on a tendency to form a stable five- or six-membered cycle in the reaction with some metal ions (especially with copper). For example, insoluble copper (II) hydroxide reacts with 1,2-diols with the formation of a dark blue coloured solution.

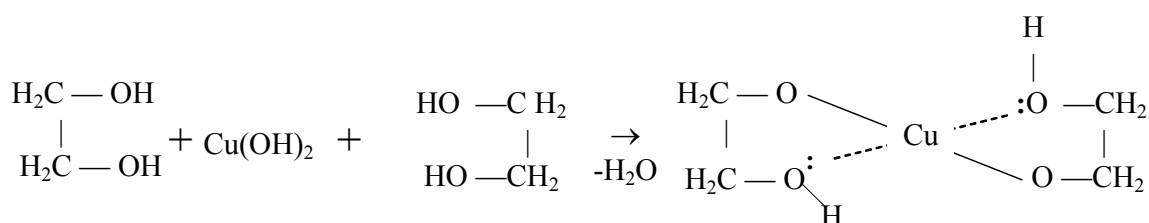

Similar complex salts are produced when  $\alpha$ -amino alcohols or  $\alpha$ -amino acids react with  $\text{Cu}(\text{OH})_2$ . These reactions are widely used as a colour test to reveal  $\alpha$ -amino acids and the diol fragment in the molecule.

### CH-acidic properties of heterofunctional compounds

Aliphatic compounds of the general formula  $\text{X}-\text{CH}_2-\text{Y}$ , in which the substituents X and Y represent electron-withdrawing groups, reveal the property of CH-acids. This is a result of polarization of the C-X and C-Y bonds. The polarization of the C-X and C-Y bond leads to subsequent polarization of the C-H bond. Amino acids, hydroxy acids and oxo acids with the second functional group at the  $\beta$  position belong to compounds of this type.

### Elimination Reactions

Elimination reactions take place readily on heating (3-hydroxy or 3-amino acids). Both types of the acids form  $\alpha, \beta$ -unsaturated acid, releasing water or ammonia, respectively:

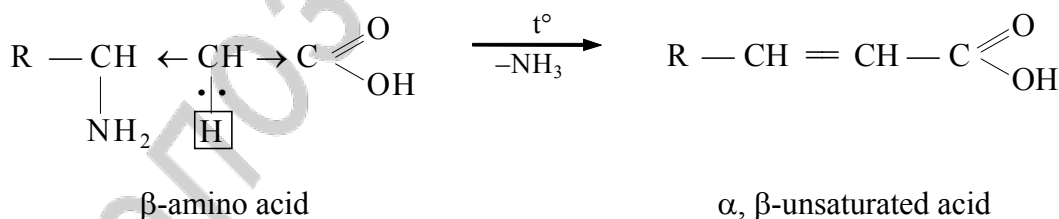
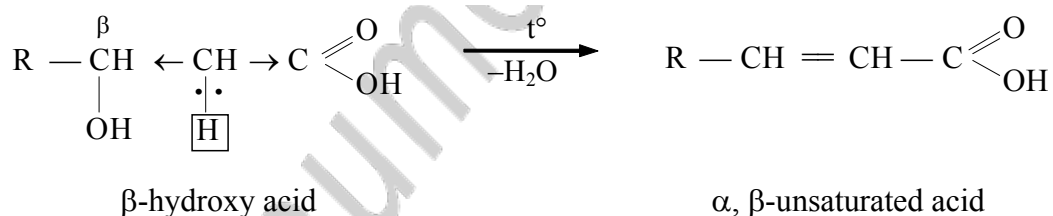

Lactic acid (IUPAC systematic name: 2-hydroxypropanoic acid), also known as milk acid, is a chemical compound that plays a role in several biochemical processes.

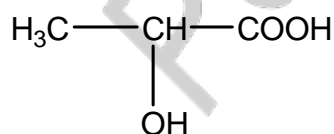

lactic acid

It was first isolated in 1780 by a Swedish chemist, Carl Wilhelm Scheele. In solution, it can lose a proton from the acidic group, producing the lactate ion  $\text{CH}_3\text{CH}(\text{OH})\text{COO}^-$ .

Lactic acid is chiral and has two optical isomers. One is known as L-(+)-lactic acid or (*S*)-lactic acid and the other, its mirror image, is D-(-)-lactic acid or (*R*)-lactic acid. L-(+)-Lactic acid is the biologically important isomer.

In animals, L-lactate is constantly produced from pyruvate via the enzyme lactate dehydrogenase in a process of fermentation during normal metabolism. Industrially, lactic acid fermentation is performed by *Lactobacillus* bacteria, among others. These bacteria can operate in the mouth; the acid they produce is responsible for the tooth decay known as caries. In medicine, lactate is one of the main components of Ringer's lactate or lactated Ringer's solution. This intravenous fluid consists of sodium and potassium cations, with lactate and chloride anions, in solution with distilled water in concentration so as to be isotonic compared to human blood. It is most com-

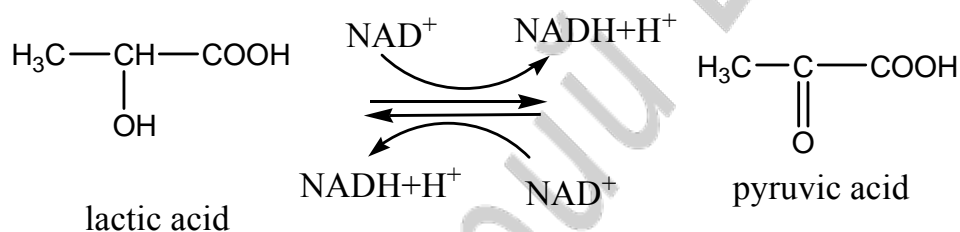

monly used for fluid resuscitation after blood loss due to trauma, surgery, or a burn injury.

**Malic acid** is the di-carboxylic acid with the formula  $\text{HO}_2\text{CCH}_2\text{CHOHCO}_2\text{H}$ . The salts and esters of malic acid are known as **malates**. Malate anion is an intermediate in the citric acid cycle along with fumarate. In vitro dehydration of malic acid gives maleic acid.

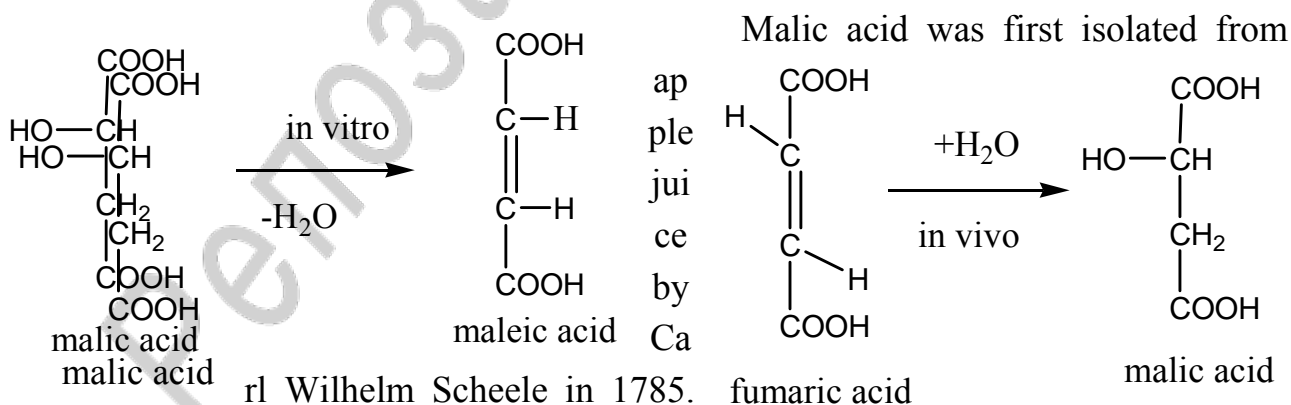

Malate plays an important role in biochemistry. In biological sources, malic acid is homochiral and only exists as the *S*-(-)-malic acid enantiomer. Malate dehydrogenase catalyzes the reversible conversion of malate into oxaloacetate using  $\text{NAD}^+$  as a cofactor. Malate is also produced from starch in guard cells of plant leaves. Malic

acid contributes to the sourness of green apple. Malic acid is present in grapes. It confers a tart taste to wine, although the amount decreases with increasing fruit ripeness. The process of malolactic fermentation converts malic acid to much milder lactic acid.

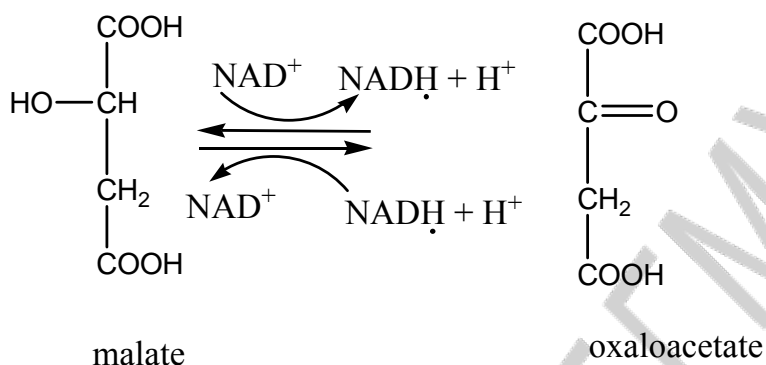

**Citric acid** which is simultaneously both  $\alpha$ - and  $\beta$ -hydroxy acid undergo similar elimination.

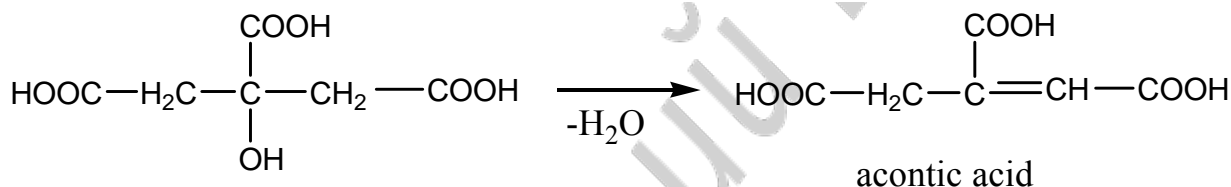

Citric acid is carboxylic acid, which contains three carboxylic groups. It can form the salts with the polyvalent metal ions. The salts of citric acid are called citrates. The Na citrate is used as anticoagulant in the conservation of donor blood. Citric acid is formed in the following reaction of the Krebs cycle.

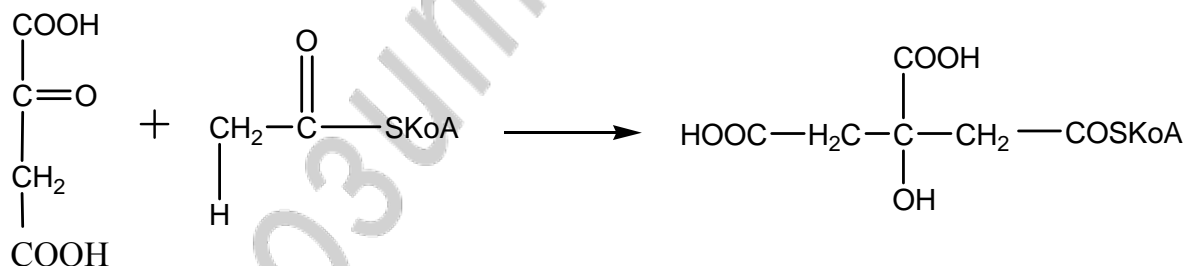

Then thioester of citric acid is hydrolysed.

Thermal dehydration of malic acid yields maleic acid in the same way. But the result of its enzymic dehydration in vivo is fumaric acid formation.

### Keto-enol tautomerism

The concept of tautomers interconvertible by tautomerizations is called **tautomerism**. **Tautomers** are organic compounds that are interconvertible by a chemical reaction called **tautomerization**. It is considered that this reaction results in the formal migration of a proton. This is prototropic tautomerism. Prototropic tautomers are sets of isomeric protonation states with the same empirical formula and

total charge. There are several types of prototropic tautomerism. Keto-enol tautomerism is more pronounced for compounds that have a strong CH-acidic site and adjacent oxo group. This is observed in  $\beta$ -oxo carboxylic acids and their derivatives. In solutions where tautomerization is possible, a chemical equilibrium of the tautomers will be reached. The ratio of the tautomers depends on several factors, including temperature, solvent, and pH. Tautomerism is a special case of structural isomerism and can play an important role in organic chemistry and biochemistry.

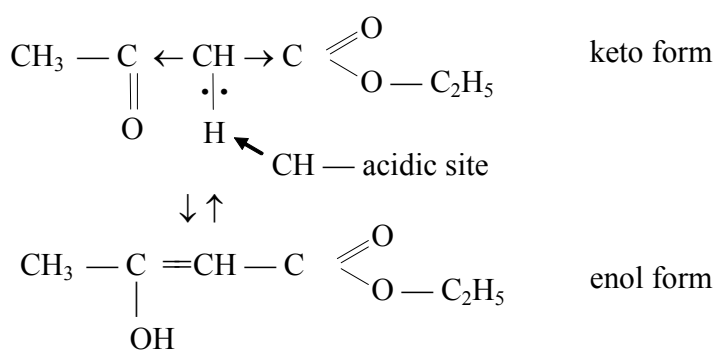

The acetoacetic ester has the CH acidic site. The proton can transfer to the oxygen atom of the oxo group to form an enol hydroxyl group and a double bond. Such form is called the enol form.

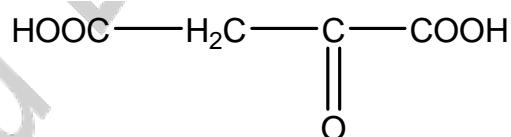

Oxalacetic acid is one of the most important carboxylic acids in many biochemical processes.

Despite its common name that corresponds to an oxo acid, this compound is a rather unsaturated acid because of the predominance of the enol form in the tautomeric equilibrium (80 %).

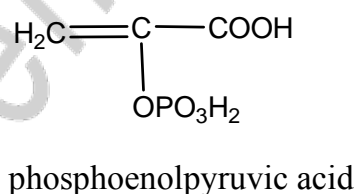
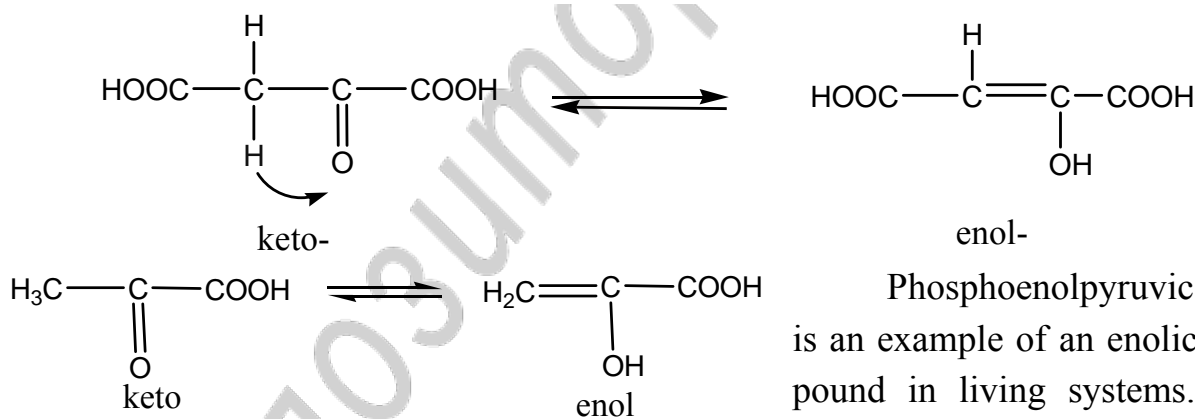

Phosphoenolpyruvic acid is an example of an enolic compound in living systems. It is produced in the glycolysis process and represents a phosphate of pyruvic acid in the enol form. Phosphoenolpyruvic acid is an energy-rich compound that

eliminates energy for its transformation to pyruvic acid.

### Decarboxylation of Heterofunctional Carboxylic Acids

Carboxylic acids with a strong electron-withdrawing group at the  $\alpha$  or  $\beta$  position can be decarboxylated. Amino and hydroxy acids as well as dicarboxylic and tri-

carboxylic acids are subjected to this reaction.  $\alpha$ -Oxo acids eliminate carbon dioxide on heating in the presence of a diluted sulfuric acid.

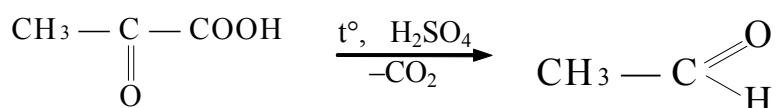

Acetoacetic acid is readily decarboxylated on slight heating to yield acetone. Decarboxylation plays an essential role in metabolic processes. So, natural  $\alpha$ -amino acids are transformed in such reactions into **biogeneous amines**.

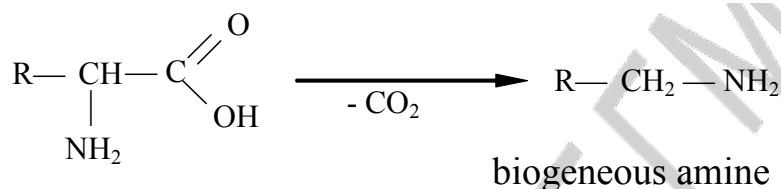

The following reaction accomplishes with the formation of 2-aminoethanol.

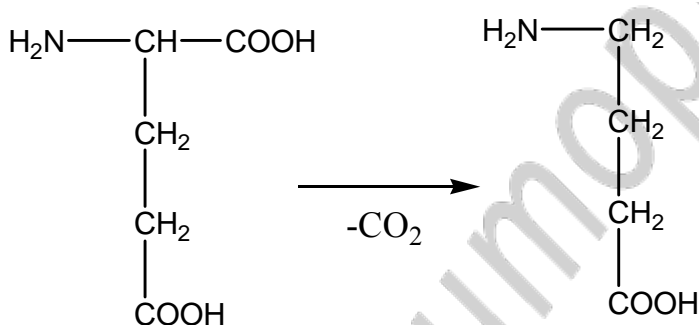
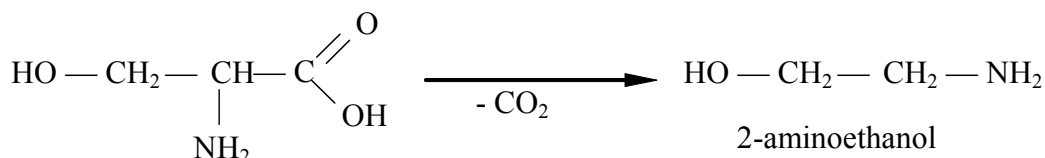

The dicarboxylic compound glutamic acid gives rise to 4-amino-butanolic acid (or  $\gamma$ -aminobutyric acid, abbreviated GABA), which is a natural neuroregulator.

**Ketone bodies** are three water-soluble compounds ([acetone](#), [acetoacetic acid](#), and [beta-hydroxybutyric acid](#)) that are produced as by-products when [fatty acids](#) are broken down for [energy](#) in the [liver](#) and [kidney](#). They are used as a source of

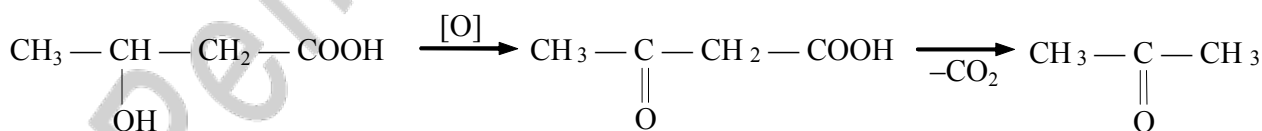

energy in the [heart](#) and [brain](#). In the brain, they are a vital source of energy during [fasting](#).



**Poly- and heterofunctional compounds,  
containing benzene or heterocycle**

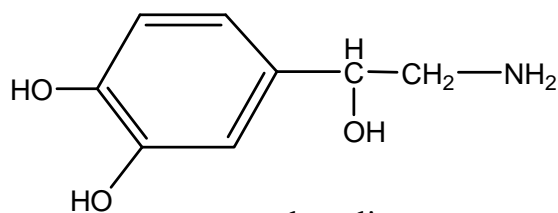

noradrenaline

A group of compounds called **catecholamines** (from the name catechol which means 1,2-dihydroxybenzene) represents biogenic amines dopamine, noradrenaline (nor-epinephrine), and adrenaline (epinephrine).

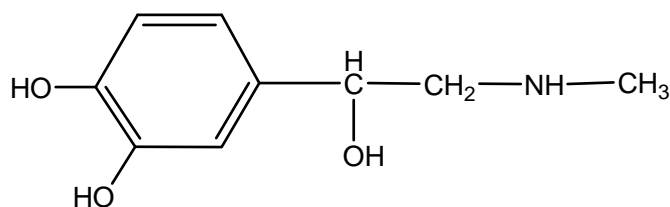

adrenaline

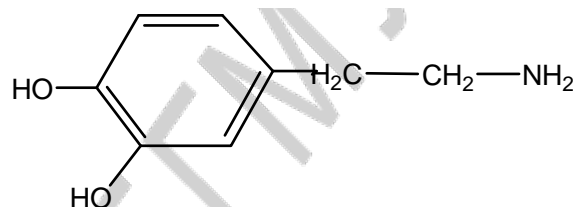

dopamine

These substances are also known as remedies stimulating adrenoreceptors.

p-Aminophenol is a toxic compound but its two derivatives are used as antipyretics and non-narcotic anesthetics. These are Paracetamol (Panadol, Tylenol, Efferalgan) and Phenacetin.

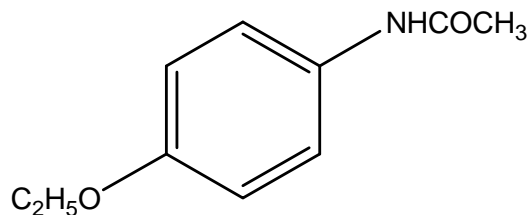
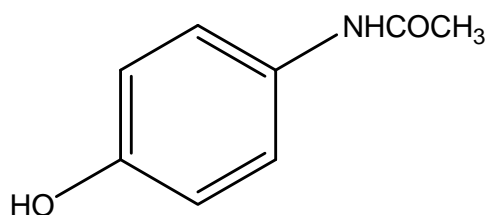

Some esters of p-aminobenzoic acid are widely used as local anesthetics. The oldest of them is the ethyl ester, or Anesthesin which is used for more than a hundred years. But more effective are ester Procaine and its soluble salt Novocain. Though currently the most effective remedies are lidocain, ultracain, containing a more steady amide bond.

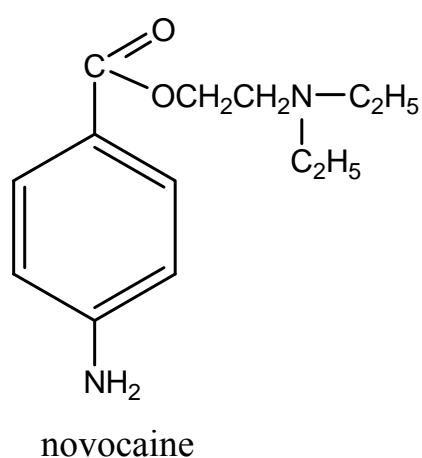
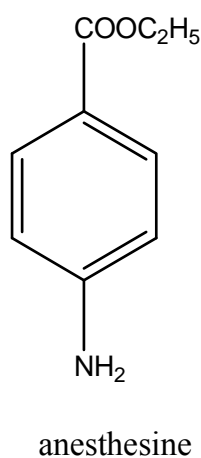
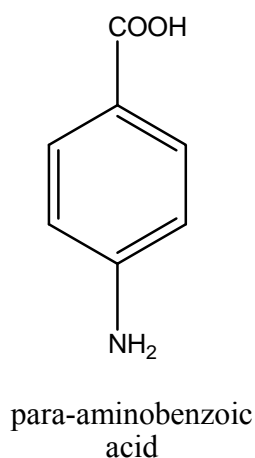

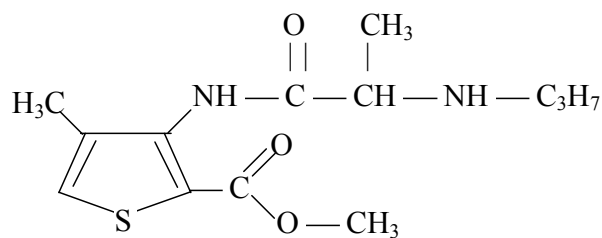

ultracaine

### Derivatives of salicylic acid

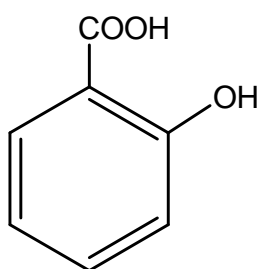

Salicylic acid forms esters in the reactions with alcohols. Esterification of acid with methanol results in the formation of methyl salicylate. The reaction of salicylic acid with acetic anhydride is used to synthesize aspirin (acetylsalicylic acid). Aspirin is a salicylate drug, often used as an analgesic to relieve minor aches and pains, as an antipyretic to reduce fever, and as an

antiinflammatory medication. It also has an antiplatelet or "anti-clotting" effect and is used in long-term, low doses to prevent heart attacks, strokes and blood clot formation in people at high risk for developing blood clots. The main undesirable side effects of aspirin are gastrointestinal — ulcers and stomach bleeding — and tinnitus, especially in higher doses. Today, aspirin is one of the most widely used medications in the world, with an estimated 40,000 metric tons of it being consumed each year.

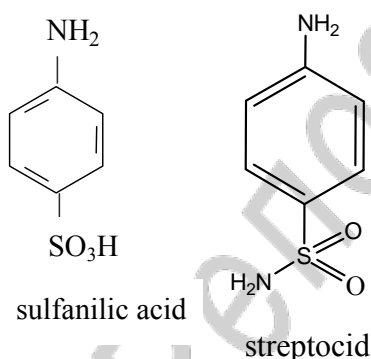
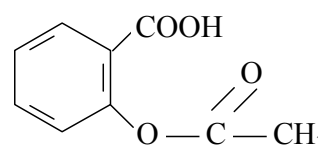

The first synthetic antibacterial remedies were **sulfa drugs**. They are derivatives of sulfanilic acid, or p-aminobenzenesulfonic acid. Its amide, sulfanilamide, is the parent compound of all sulfa drugs. There are several sulfonamide-based groups of drugs. The original antibacterial sulfonamides are synthetic antimicrobial agents that contain the sulfonamide group.

In bacteria, antibacterial sulfonamides inhibits synthesis of folate (vitamine B<sub>c</sub>) because of sulfonamide molecule is similar to molecule of p-aminobenzoic acid, which is necessary for synthesis of

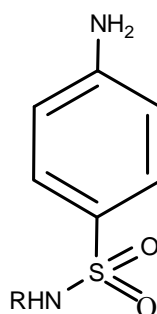

a common formula of sulfa drugs

**folate**. Folate is necessary for the cell to synthesize nucleic acids, and in its absence cells will be unable to divide. Hence the sulfonamide antibacterials exhibit a bacteriostatic rather than bactericidal effect. Folate is not synthesized in mammalian cells, but is instead a dietary requirement. This explains the selective toxicity to bacterial cells of these drugs.

**An antimetabolite is a chemical with a similar structure to a substance a metabolite) required for normal biochemical reactions, yet different enough to interfere with the normal functions of cells, including cell division.**

Sulfonamides are prepared by the reaction of a sulfonyl chloride with ammonia or an amine.

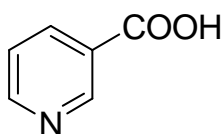

nicotinic acid

**Nicotinic acid** (or vitamin B<sub>3</sub>) is the organic compound with the formula HO<sub>2</sub>CC<sub>5</sub>H<sub>4</sub>N. This water-soluble, colourless solid is a derivative of pyridine, featuring a carboxylic acid functional group at the 3-position. The designation **vitamin B<sub>3</sub>** also includes the corresponding **nicotinamide**, where in the COOH group has been replaced by a CONH<sub>2</sub> group. Nicotinic acid is converted to nicotinamide *in vivo*. **Nicotinamide** is a precursor to NADH, NAD<sup>+</sup>, which play essential metabolic roles in living cells.

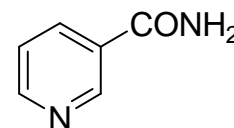

nicotinamid

**Isonicotinic acid** is an organic compound with a carboxyl group on a pyridine ring. It is an isomer of nicotinic acid — the carboxyl group for isonicotinic acid is on the 4-position instead of the 3-position for nicotinic acid. **Isonicotinic acids** is a term loosely used for derivatives of isonicotinic acid. **Isoniazid and phthivazid** are a first-line antituberculous medications used in the prevention and treatment of tuberculosis. Isoniazid is never used on its own to treat active tuberculosis because resistance quickly develops.

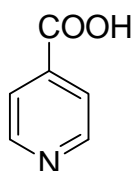

isonicotinic acid

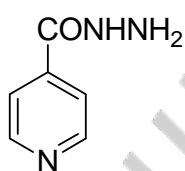

isoniazid

**Isonicotinic acid** is an organic compound with a carboxyl group on a pyridine ring. It is an isomer of nicotinic acid — the carboxyl group for isonicotinic acid is on the 4-position instead of the 3-position for nicotinic acid. **Isonicotinic acids** is a term loosely used for derivatives of isonicotinic acid. **Isoniazid and phthivazid** are a first-line antituberculous medications used in the prevention and treatment of tuberculosis. Isoniazid is never used on its own to treat active tuberculosis because resistance quickly develops.

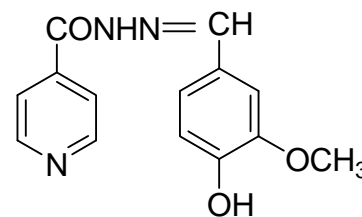

phthivazid

**Isonicotinic acids** is a term loosely used for derivatives of isonicotinic acid. **Isoniazid and phthivazid** are a first-line antituberculous medications used in the prevention and treatment of tuberculosis. Isoniazid is never used on its own to treat active tuberculosis because resistance quickly develops.

**Barbituric acid** is an organic compound based on a pyrimidine heterocyclic skeleton. Barbituric acid is the parent compound of a large class of barbiturates that have central nervous system de-

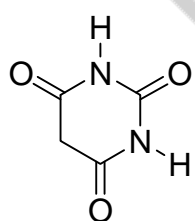

barbituric acid

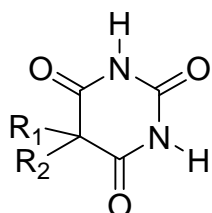

the general formula of barbiturates

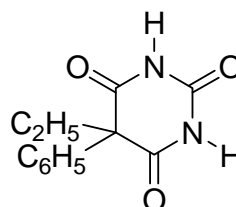

phenobarbital

pressant properties although barbituric acid itself is not pharmacologically active. The compound was discovered by the German chemist Adolf von Baeyer by combining urea and malonic acid in a condensation reaction. Barbituric acid has the ability to exist in the different tautomeric forms.

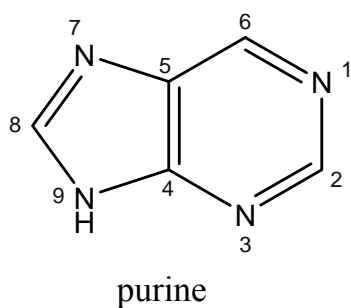
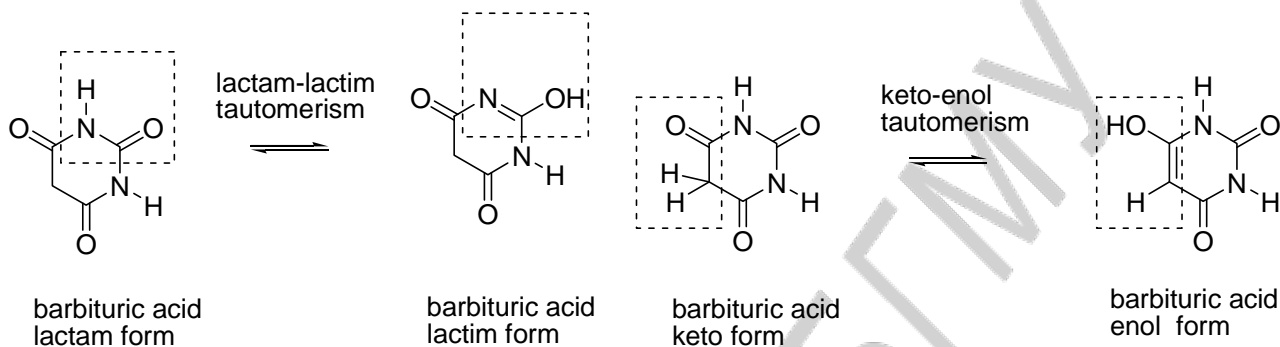

Hypoxanthine is a naturally occurring purine derivative. It is occasionally found as a constituent of nucleic acids where it is present in the anticodon of tRNA in the form of its nucleoside inosine. It is also known as 6-hydroxypurine. Hypoxanthine is a necessary additive in certain cell, bacteria and parasite cultures as a substrate and nitrogen source. It is one of the products of the action of xanthine oxidase on xanthine.

Uric acid is an organic compound of carbon, nitrogen, oxygen and hydrogen with the formula  $C_5H_4N_4O_3$ . In humans and higher primates, uric acid is the final oxidation product of purine catabolism. In most other mammals, the enzyme uricase further oxidizes uric acid to allantoin. In humans, about half the antioxidant capacity of plasma comes from uric acid. Uric acid forms two series of

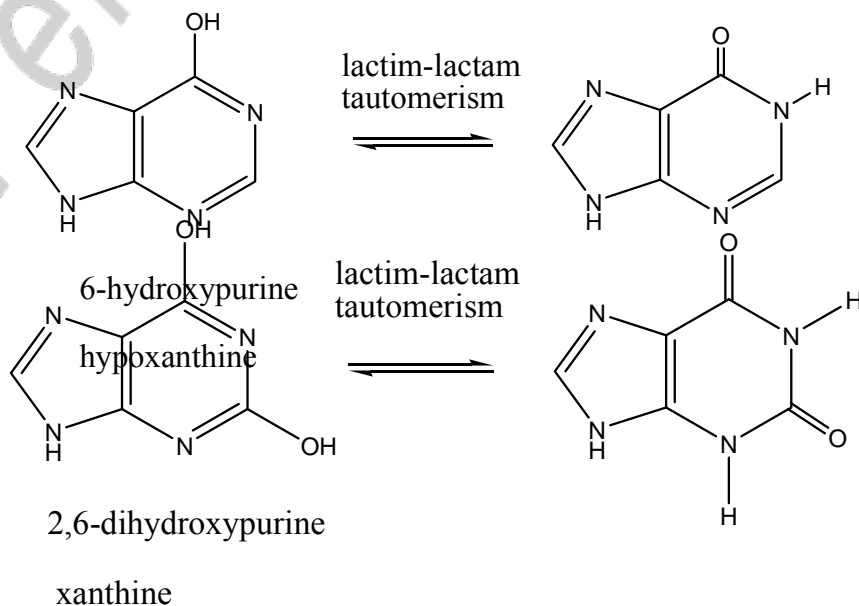



more was discovered about a certain alkaloid, the grouping is changed to reflect the new knowledge, usually taking the name of a biologically-important amine that stands out in the synthesis process.

- Pyridine group.
- Pyrrolidine group: hygrine, cuscohygrine, nicotine.
- Tropane group: atropine, cocaine, ecgonine, scopolamine, catuabine.
- Quinoline group: quinine, quinidine, dihydroquinine, dihydroquinidine, strychnine, brucine, veratrine, cevadine.
- Isoquinoline group: the opium alkaloids (morphine, codeine, thebaine, Isopapa-dimethoxy-aniline, papaverine, narcotine, sanguinarine, narceine, hydrastine, berberine), emetine, berbamine, oxyacanthine.
- Phenethylamine group: mescaline, ephedrine, dopamine, amphetamine.
- Indole group.
- Purine group: xanthines: caffeine, theobromine, theophylline.
- Terpenoid group: aconite alkaloids: aconitine.
- Vinca alkaloids: vinblastine, vincristine. They are antineoplastic and bind free tubulin dimers thereby disrupting balance between microtubule polymerization and depolymerization resulting in the arrest of cells in metaphase.
- Miscellaneous: capsaicin, cynarin, phytolaccine, phytolaccotoxin

### **Physicochemical properties**

Low-molecular weight alkaloids without hydrogen bond donors such as hydroxy groups are often liquid at room temperature, examples are nicotine, sparteine, coniine, and phenethylamine.

Basicity of alkaloids depends on the lone pairs of electrons on their nitrogen atoms. As organic bases, alkaloids form salts with mineral acids such as hydrochloric acid and sulfuric acid and organic acids such as tartaric acid or maleic acid. These salts are usually more water-soluble than their free base form.

**Nicotine** is an alkaloid found in the nightshade family of plants, predominantly in tobacco and coca, and in lower quantities in tomato, potato. Nicotine has been

found to constitute approximately 0,6–3,0 % of dry weight of tobacco, with biosynthesis taking place in the roots, and accumulating in the leaves. It functions as an antiherbivore chemical, being a potent neurotoxin with particular specificity to insects; therefore nicotine was widely used as an insecticide in the past, and currently nicotine derivatives such as imidacloprid continue to be widely used.

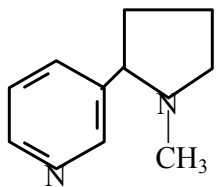

In low concentrations (an average cigarette yields about 1 mg of absorbed nicotine), the substance acts as a stimulant in mammals and is one of the main factors responsible for the dependence-forming properties of tobacco smoking.

Nicotine acts on the nicotinic acetylcholine receptors, specifically the ganglion type nicotinic receptor.

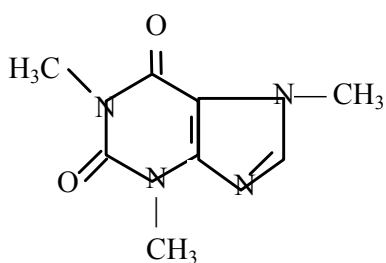

caffeine

Caffeine is a bitter white crystalline xanthine alkaloid that acts as a psychoactive stimulant drug and a mild diuretic in humans and animals. Caffeine was discovered by a German chemist, Friedrich Ferdinand Runge, in 1819. He coined the term "kaffein", a chemical compound in coffee, which in English became caffeine. Caffeine is found in varying quantities in the beans, leaves, and fruit of over 60 plants, where

it acts as a natural pesticide that paralyzes and kills certain insects feeding on the plants. The most commonly used caffeine-containing plants are coffee, tea, and to a lesser extent cocoa.

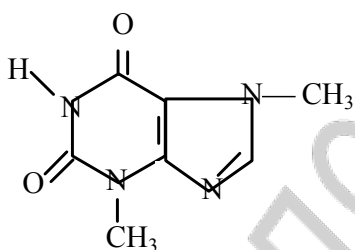

theobromine

Many natural sources of caffeine also contain widely varying mixtures of other xanthine alkaloids, including the cardiac stimulants theophylline and theobromine and other substances such as polyphenols which can form insoluble complexes with caffeine.

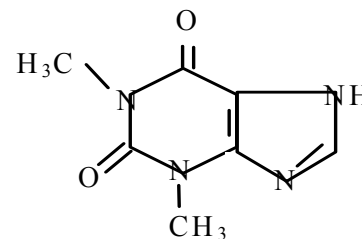

theophylline

The world's primary source of caffeine is the coffee bean, from which coffee is brewed. Caffeine content in coffee varies widely depending on the type of coffee bean and the method of preparation used; even beans within a given bush can show variations in concentration. Coffee also contains trace amounts of theophylline, but no theobromine.

Tea is another common source of caffeine. Tea usually contains about half as much caffeine per serving as coffee, depending on the strength of the brew. Tea contains small amounts of theobromine and slightly higher levels of theophylline than coffee. Preparation has a significant impact on tea, and color is a very poor indicator of caffeine content. Teas like the pale Japanese green tea gyokuro, for example, contain far more caffeine than much darker teas like lapsang souchong, which has very little.

**Morphine** is the narcotic drug and is the standard against which all other opioids are tested. It interacts predominantly with the μ-opioid receptor. These μ-binding sites are discretely distributed in the human brain, with high densities in the posterior amygdala, hypothalamus, thalamus, nucleus caudatus, putamen, and certain cortical areas. They are also found on the terminal axons of primary afferents within laminae I and II (substantia gelatinosa) of the spinal cord and in the spinal nucleus of the trigeminal nerve.

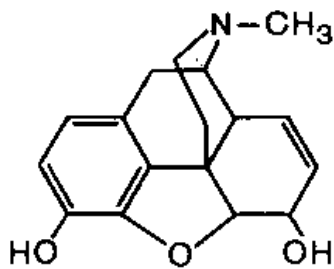

Activation of the μ-opioid receptors is associated with analgesia, sedation, euphoria, physical dependence, and respiratory depression. Morphine is a rapid-acting narcotic, and it is known to bind very strongly to the μ-opioid receptors, and for this reason, it often has a higher incidence of euphoria/dysphoria, respiratory depression, sedation, pruritus, tolerance, and physical and psychological dependence when compared to other opioids at equianalgesic doses.

**Atropine** is a tropane alkaloid extracted from the deadly nightshade (*Atropa belladonna*) and other plants of the family Solanaceae. It is a secondary metabolite

of these plants and serves as a drug with a wide variety of effects. It is a

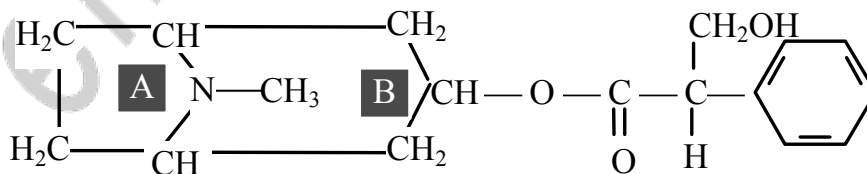

competitive antagonist for the muscarinic acetylcholine receptor. It is classified as an anticholinergic drug.



## **Lipids, Classification, Properties. Phospholipids as Structural Components of Biological Membranes**

Within the frames of this theme we'll consider the classification and the chemical properties of various lipids and their components, discuss the structure, physical and chemical properties of the saponifiable and unsaponifiable lipids, their biological role (energetical and structural). **The definition of lipids:**

**Lipids represent a large group of natural hydrophobic compounds with a various structure and biological functions.**

They are united in a single category on the basis of the following three main criteria:

- 1) almost completely insoluble in water and soluble in nonpolar solvents such as heptane, diethyl ether, methanol, chloroform, acetone, etc;
- 2) presented in nature in the form of the esters of the fatty acids;
- 3) presented in all living organisms.

### **Lipid functions**

Lipids perform mainly the following biological functions:

1. They are components of biological membranes.
2. Serve as the basic form of energy and carbon storage.
3. Can be the predecessors of other important compounds (prostaglandins, thromboxane thromboxanes, leukotrienes).
4. Play the role of the protective barriers, defending organs and tissues from thermal, electric and physical impacts.
5. They are the part of the protective capsules, defending from infections and excessive loss or accumulation of water.

### **Lipid Classification**

Lipids can be classified:

- 1) according to their functions;
- 2) in relation to hydrolysis and the chemical structure.

According to the functions lipids are divided into:

- a) reserve lipids (fats of fatty depots); their quantity and structure are changeable and depend on the diet and the physical state of the organism;
- b) structural lipids — their quantity and structure in an organism are constant, genetically caused and normally do not depend on a diet and the state of an organism.

In relation to hydrolysis lipids are divided into hydrolysable and non-hydrolysable lipids. Historically, steroids, terpenes, carotenoids and others refer to non-hydrolysable lipids. Hydrolysable lipids undergo hydrolysis. During their hydrolysis polyhydroxyl alcohols and soaps — potassium or sodium salts of the fatty acids, and also some other components (phosphoric, sulfuric acids, amino alcohols, carbohydrates, some amino acids and other compounds) are formed.

### Alcohols as a structural part of lipids

Polyhydroxyl alcohols contain a carbon chain consisting of three and more carbon atoms: glycerol, propanediol-1,2, or butanediol-1,3 and also monosaccharides that can act as alcohol (glucose, galactose, etc.).

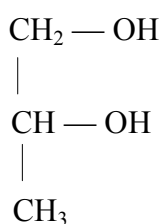

propanediol-1,2,

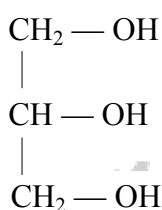

glycerol

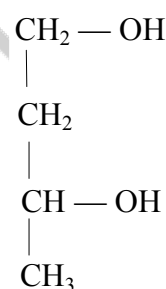

butanediol-1,3

Sphingosin is found in the structure of nervous tissue lipids — ceramides and sphingomyelins.

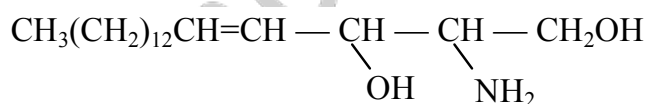

sphingosin

Cholesterol is the secondary unsaturated alcohol of the sterane range.

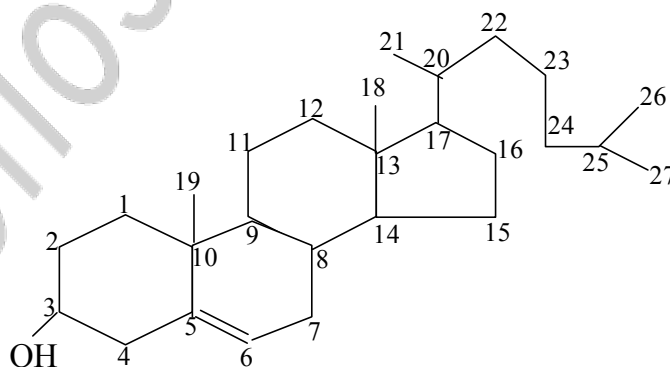

Cholesterol is referred to 5 $\alpha$ -steroids. A 3 $\beta$ -OH-group occupies energetically more favourable equatorial position. Cholesterol is a part of chylomicrons, lipoproteids, biological membranes.

## Simple lipids

They are the lipids formed during the hydrolysis of which polyhydroxyl alcohol and the fatty acids (or their derivatives — soaps) are formed. Simple lipids are divided into two groups: 1) neutral acylglyceroles and 2) waxes.

Neutral acylglyceroles (fats) represent esters of glycerole and the fatty acids. According to the number of esterified hydroxyl groups there are monoacylglyceroles, diacylglyceroles and triacylglyceroles. The most widespread acylglyceroles in nature are triacylglyceroles. In all cases acylglyceroles do not contain functional ionogenic groups and are referred to neutral lipids.

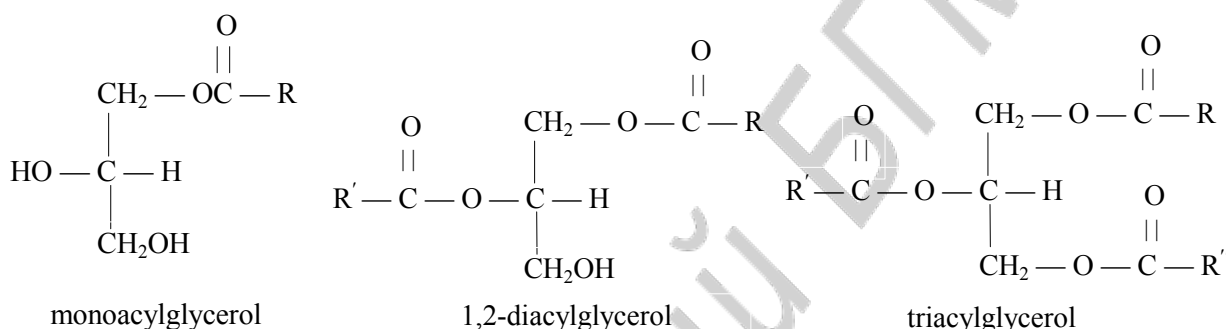

Triacylglycerole, which contains the radicals of the same fatty acids, is called simple neutral fat. The mixed fats contain the different radicals of the fatty acids. According to the character of the fatty acid radicals (saturated or unsaturated) there are solids (fats) and liquids (oils).

Human and animal body fat are mixed fats with the prevalence of the unsaturated fatty acids.

### Triacylglyceroles nomenclature

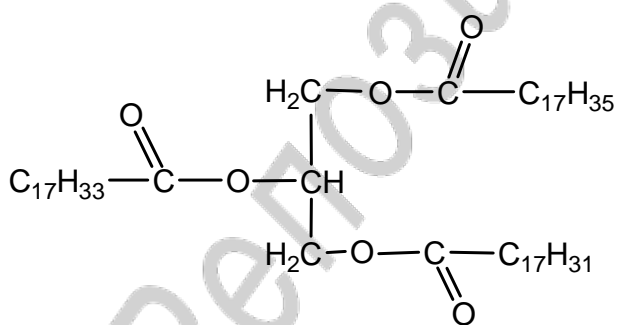

1-stearoyl-2-oleoyl-3-linoleoylglycerol

The names of the mixed triacylglyceroles according to the international nomenclature are formed by the addition of a suffix "oil" to the name of the corresponding acyl radical of the fatty acid. The number underlines its position in a carbon chain of the polyhydroxyl alcohol and ending with glycerole.

### Physical and chemical properties

Triacylglyceroles are hydrophobic substances, the melting temperature depends on the fatty acid degree of nonsaturation. The vegetative fats (oils) containing mono-

and polyunsaturated fat acid, have lower melting temperature. The degree of unsaturation is characterized by iodine number.

**Biological value.** In animal and human tissues triacylglycerols have three special functions:

- in fatty tissue they form the so-called fatty deposits, representing the form of energy and carbon storage;
- in a structure of lipoprotein particles, which acquire fatty acids in the form of triacylglycerols, are transferred through the lymphatic system and the blood channel;
- triacylglycerols play the role of physical protection and a temperature regulator of various body organs.

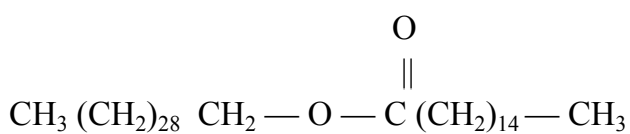

miricypalmitate

**Waxes** are the esters formed by the polyhydroxyl alcohols and the fatty acids. They are absolutely insoluble in water. Synthetic and natural waxes are widely applied in medicine, particularly

in stomatology. Natural waxes are the end-products of metabolic ways, which help to form sheetings. For example, bee-wax.

### Complex lipids

There are three basic classes of complex lipids:

- phospholipids;
- glycolipids;
- sphingolipids.

Phospholipids and glycolipids are considered in separate groups, but sphingolipids may relate to either first and the second sections. Hence, glycerophospholipids and sphingophosphotides are referred to phospholipids.

Glycerophospholipids (phosphoacylglyceroles) are derivatives of phosphatidic acid. Phosphoacylglyceroles are formed by esterification of a phosphatic group and one of the substances: serine, ethanolamine, choline, inositol, glycerol, phosphotidil-glycerol, etc.

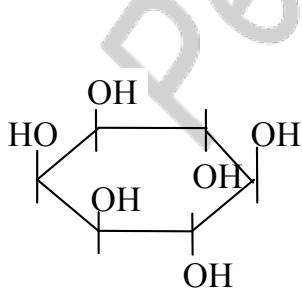

inositol

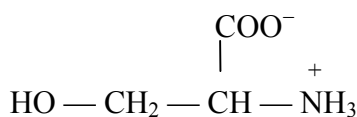

serine

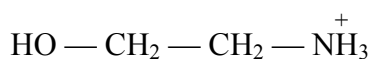

ethanolamine



choline

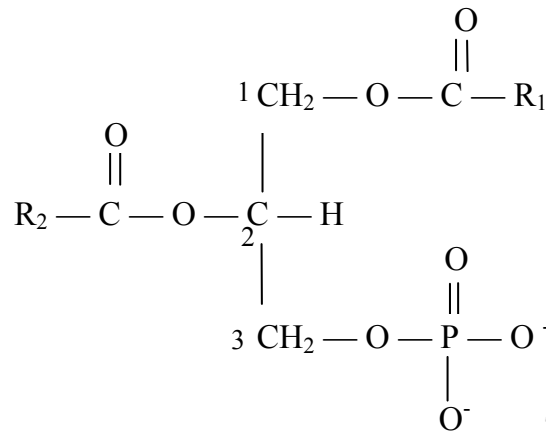

Phosphatidic acid

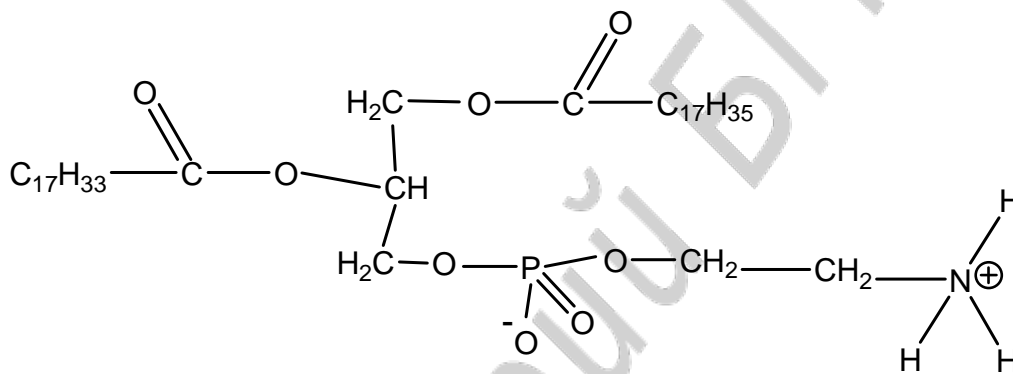

1-stearoyl-2-oleoylphosphatidylcholine

All phospholipids incorporate a waterproof part or nonpolar radicals of the saturated and nonsaturated fatty acids ("tails") and a hydrophilic part or a polar "head", including the residuals of glycerol, phosphoric acid and amino alcohol. The molecule of phospholipids has amphiphilic nature and is capable to settle down in appropriate way on the border of two phases, thus which providing the formation lipid double layer membranes.

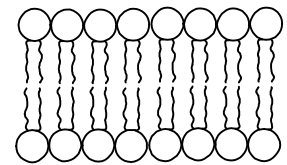

Similar to phospholipids and sphingomyelins, glycolipids perform a structural function. Biological membranes are cell structures, which separate cytoplasm and the majority of intracellular organelles. They also form a single intracellular system of canals, folds and closed cavities. The basic components of membranes are lipids (30–35 % from the general dry weight of a membrane), proteins (55–60 %) and carbohydrates (5–10 %). There are also small quantities of nucleic acids (minor components, less than 1 % in weight), polyamines, inorganic ions, etc. The correlation of these components varies depending on the type of membranes. Phospholipids make 30–35 % of a typical biomembrane weight. A lipid matrix in the form of a continuous double layer (bilayer) is a structural basis of biomembranes. Amphiphilic lipid molecules

are directed to each other by hydrophobic tails in this bilayer. It is formed spontaneously owing to diphility of lipid molecules.

The lipid bilayer spontaneously forms vesicles, which separate two water media — cytoplasm and the extracellular medium. Concentrations of different types of lipids, proteins and carbohydrates differ on the two surfaces of biomembranes. It is caused by the structural features and synthesis of phospholipids molecules, asymmetric localization of proteins and lipids in the bilayer, a various ionic structure of cytoplasm and interstitial fluid. A bilayer asymmetry is also provided by enzymes of lipid metabolism and lipid-transportation proteins. For example, human blood cells contain glycolipids (sphingomielin) and positively charged phosphodithylholin in the external exoplasm layer.

**Lipid peroxidation** refers to the oxidative degradation of lipids. It is the process whereby free radicals "steal" electrons from the lipids in cell membranes, resulting in cell damage. This process proceeds by a free radical chain reaction mechanism. It most often affects polyunsaturated fatty acids, because they contain multiple double bonds in between which lie methylene  $-\text{CH}_2-$  groups that possess especially reactive hydrogens. As with any radical reaction the reaction consists of three major steps: initiation, propagation and termination.

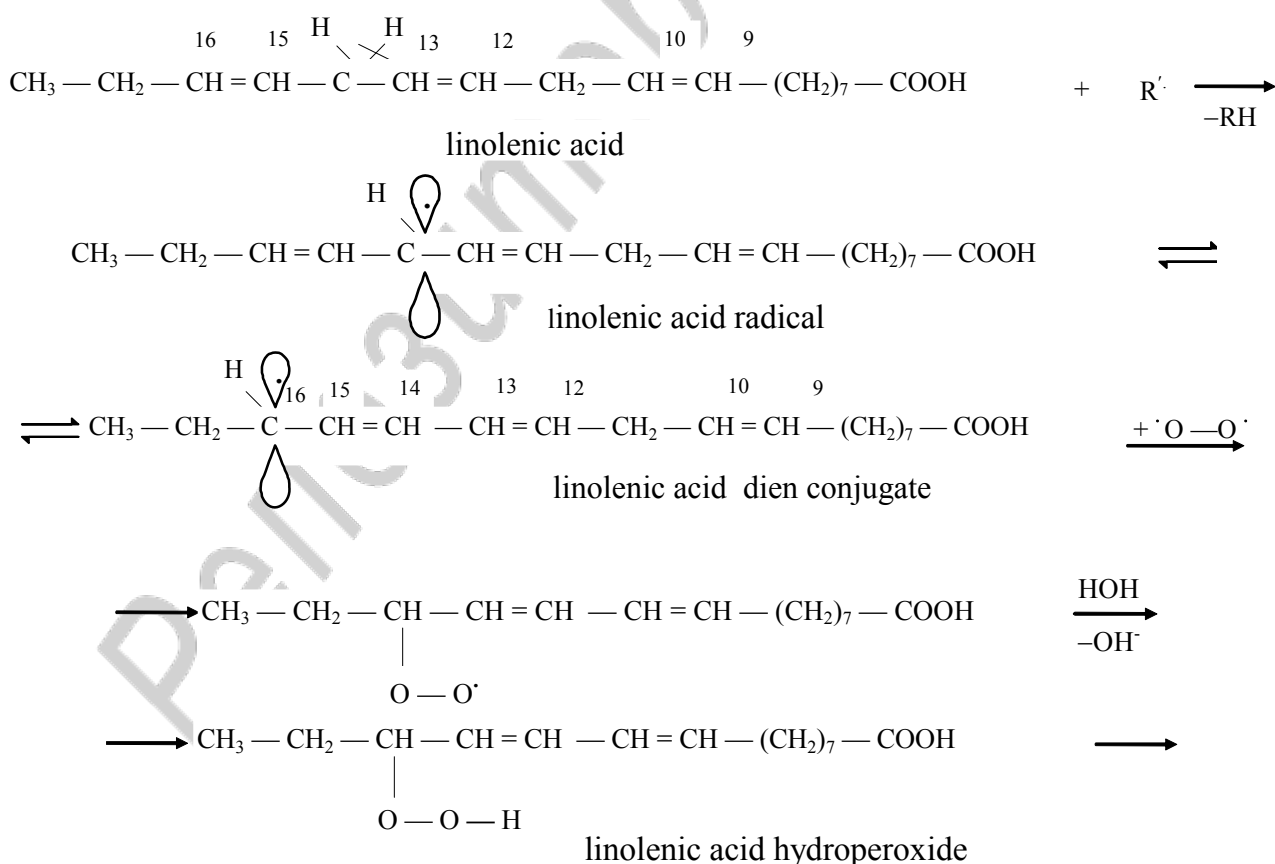

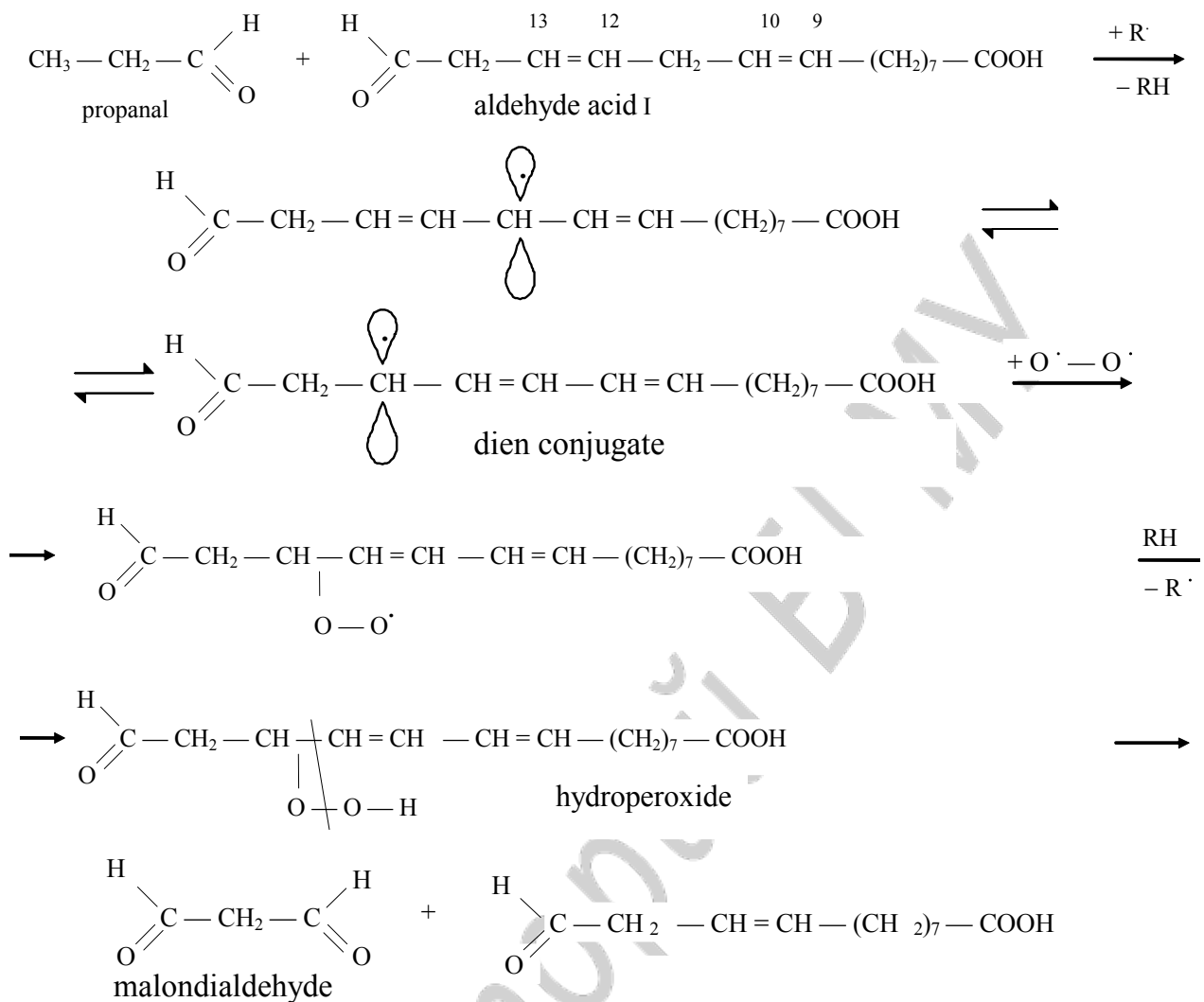

Initiation is the step whereby a fatty acid radical is produced. The initiators in living cells are most notably reactive oxygen species (ROS), such as  $\text{OH}^\cdot$ , which combines with a hydrogen atom to make water and a fatty acid radical. The following step is propagation. The fatty acid radical is not a very stable molecule, so it reacts readily with molecular oxygen, thereby creating a peroxy-fatty acid radical. This too is an unstable species that reacts with another free fatty acid producing a different fatty acid radical and a hydrogen peroxide or a cyclic peroxide if it had reacted with itself. This cycle continues as the new fatty acid radical reacts in the same way. When a radical reacts it always produces another radical, which is why the process is called a "chain reaction mechanism". The radical reaction stops when two radicals react and produce a non-radical species. This happens only when the concentration of radical species is high enough for there to be a high probability of two radicals actually colliding. Living organisms have evolved different molecules that speed up termination by catching free radicals and therefore protect the cell membrane. One important such antioxidant is alpha-tocopherol, also known as vitamin E. Other anti-

oxidants made within the body include the enzymes superoxide dismutase, catalase, and peroxidase.

If not terminated fast enough, there will be damage to the cell membrane, which consists mainly of lipids. Phototherapy may cause hemolysis by rupturing red blood cell membranes in this way. In addition, end products of lipid peroxidation may be mutagenic and carcinogenic. For instance, the end product malondialdehyde reacts with deoxyadenosine and deoxyguanosine in DNA, forming DNA adducts to them.

Репозиторий БГМУ



## Monosaccharides. Structure, Tautomeric Forms, Reactivity, Biological Role

**Carbohydrates** (from "hydrates of carbon") or saccharides (from Greek word meaning "sugar") are the most abundant of the four major classes of biomolecules, which also include proteins, lipids and nucleic acids. They play numerous roles in living things, such as the storage and transport of energy (starch, glycogen) and structural components (cellulose in plants, chitin in animals). Carbohydrates and their derivatives play major roles in the working process of the immune system, fertilization, pathogenesis, blood clotting, and development.

Chemically, carbohydrates are organic compounds that are aldehydes or ketones with many hydroxyl groups added. The general stoichiometric formula of carbohydrate is  $C_x(H_2O)_y$ . Carbohydrates are initial products of photosynthesis formed from carbon dioxide and water.

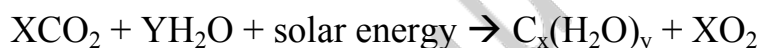

Carbohydrates include very different types of compounds, from small molecules with several carbon atoms to polymers with a molecular mass amounting millions.

Towards hydrolysis carbohydrates are divided into three big groups (or sub-classes):

- monosaccharides, general formula is  $(C \cdot H_2O)_n$  (or  $C_nH_{2n}O_n$ ), where  $n=3-10$ ;
- oligosaccharides,  $(C_6H_{10}O_5)_n$ , where  $n < 10$ ;
- polysaccharides  $(C_6H_{10}O_5)_n$ , where  $n < 10$ .

The names of carbohydrates often end in the suffix -ose.

**Monosaccharides** (from Greek *monos*: single, *sacchar*: sugar) are the simplest carbohydrates. They cannot be hydrolyzed into simpler sugars.

They consist of one sugar and are usually colorless, water-soluble, crystalline solids. Some monosaccharides have a sweet taste.

### Classification of monosaccharides

There are some classifications of monosaccharides among them the following

- Based on the number of carbon atoms (a pentose, for example, contains five carbon atoms; hexose is a six-carbon monosaccharide and etc.).
- Based on the aldehyde or ketone group presence (aldoses contain aldehyde group, ketoses contain ketone (or oxo-) group).
- Based on the stereoisomeric rows (according to the last chiral carbon atom configuration there are D- and L-stereoisomers).

– Based on the different anomeric forms (anomers belong to the  $\alpha$ - and  $\beta$ -type, depending on the position of the OH-group).

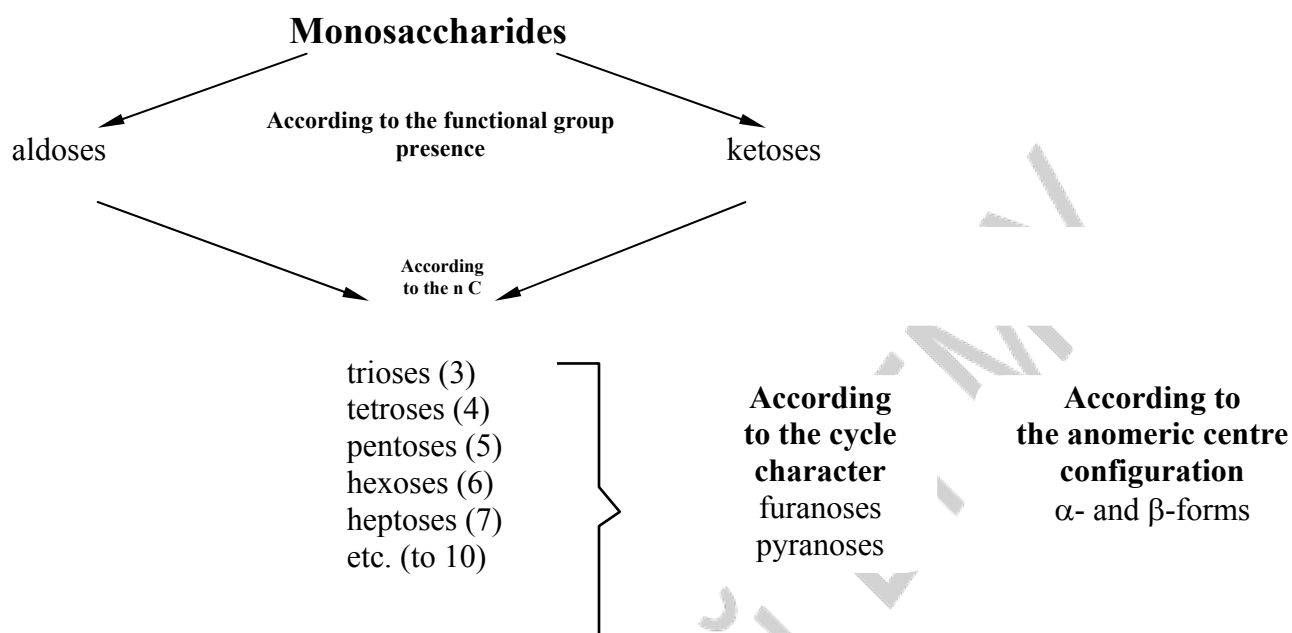

Examples of monosaccharides include glucose (dextrose), fructose, galactose, xylose and ribose. Monosaccharides are the building blocks of disaccharides like sucrose (common sugar) and polysaccharides (such as cellulose and starch). Further, each carbon atom that supports a hydroxyl group (except for the first and last) is chiral, giving rise to a number of isomeric forms all with the same chemical formula. For instance, galactose and glucose are both aldohexoses, but they have different chemical and physical properties.

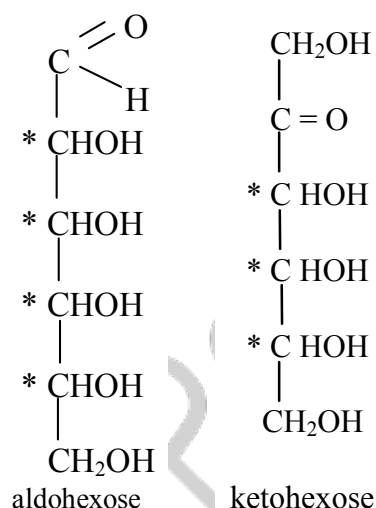

### Monosaccharide structure

**Glucose** is  $\text{C}_6\text{H}_{12}\text{O}_6$ , grape-sugar. It contains 5 OH-groups because reacting with five acid equivalents form ester. Each of five carbon atoms contains one OH-group. Therefore, glucose is aldohexose.

**Fructose** is  $\text{C}_6\text{H}_{12}\text{O}_6$ , fruit-sugar. It gives qualitative reaction on the polyatomic alcohols (with  $\text{Cu}(\text{OH})_2$ ), reacts with five acid equivalents forming ester. Therefore it contains five OH-groups and it's called ketohexose.

### Monosaccharide stereoisomerism

Solutions of monosaccharides possess optical activity due to the chiral centres presence in the structure.

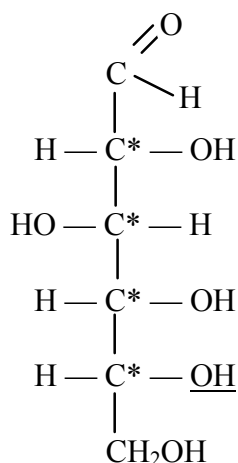

D-glucose  
on E. Fisher, +52,5°

### Aldohexose stereoisomerism

In the acyclic form of an aldohexose four carbon atoms are asymmetric. And aldohexose can exist as 16 stereoisomers according to the formula ( $N=2^4$ ). Among them 8 belong to the D-row and 8 belong to the L-row. In equilibrium state glucose solutions possess the right rotation (+52,5°), that's why glucose is sometimes called dextrose.

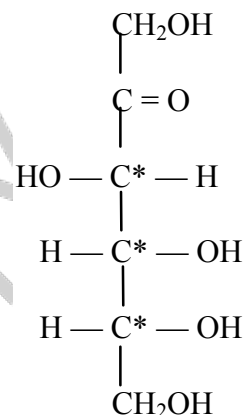

D-fructose  
on E. Fisher, -82°

### Ketohexose stereoisomerism

In the a acyclic form of an ketohexose three carbon atoms are asymmetric. And ketohexose can exist as 8 stereoisomers. One of these stereoisomers is a natural D-fructose that possesses the left rotation (-82°).

### Tautomeric cyclic forms of monosaccharides

Monosaccharides exist preferably in the cyclic (hemiacetal) form. The cyclic hemiacetal structures are formed in case when the OH group comes within reacting distance of the aldehyde (or ketone) carbon. Interaction of the two functional groups results in the cyclic, six-membered (furanose cycle) or five-membered (pyranose cycle) that are more stable in the chelate conformation. In these reactions  $C_1$  atom becomes assymetryc and the number of stereoisomers increases in two times (32). OH group formed from aldehyde group is called hemiacetal or glycosidic group.

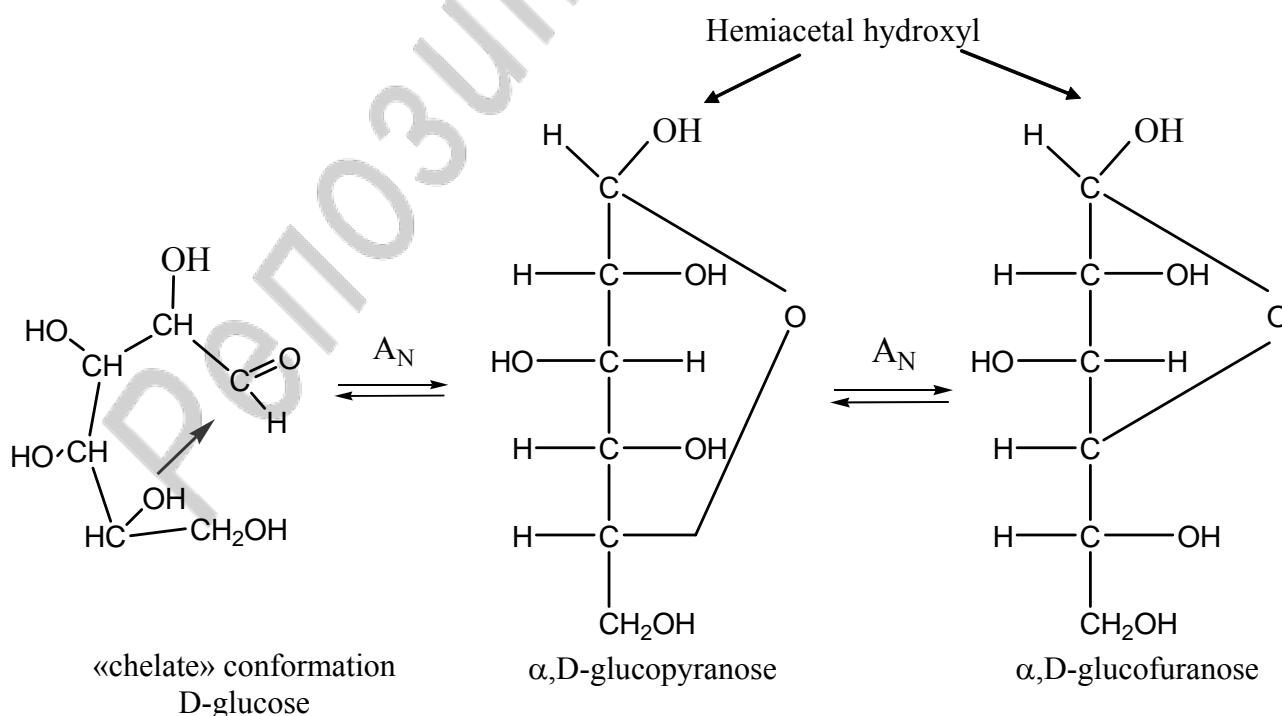

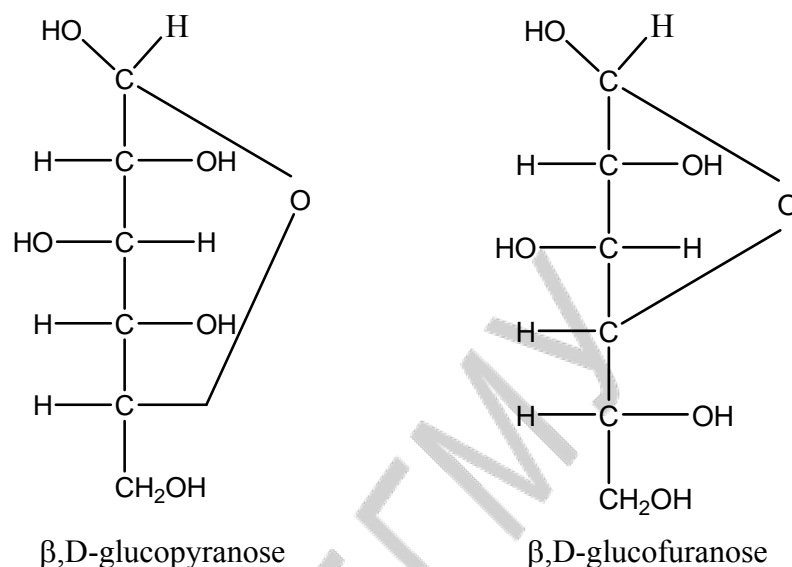

### Fisher`s cyclic formulas

It differs from other OH-groups of monosaccharide according to the chemical properties. Additional chiral centre (symbol  $C_1^*$ ) formation leads to new stereoisomeric (anomeric)  $\alpha$ - and  $\beta$ -forms. In the  $\alpha$ -anomeric form the hemiacetal OH-group is “down” and in the  $\beta$ -form the hemiacetal OH-group is “up”.

Interconversions of different monosaccharide forms in a solution is called ring-chain tautomerism.

### Mutarotation

Anomeric  $\alpha$ - and  $\beta$ -forms have a different angle of polarized light rotation. So,  $\alpha$ ,D-glucopyranose rotates on the  $+112,5^\circ$ , and  $\beta$ ,D-glucopyranose rotates on the  $+19,3^\circ$ . When solved in water equilibrium between these forms is settled:

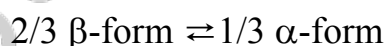

Rotation angle of this equilibrium equals to  $+52,5^\circ$ .

### Fructose tautomeric forms

Fructose (or laevulose) is a [monosaccharide](#) found in many foods and is one of the three important dietary monosaccharides along with [glucose](#) and [galactose](#). Tree fruits, [berries](#), [melons](#), and some root vegetables, such as [beets](#), [sweet potatoes](#), [parsnips](#), and [onions](#), contain fructose, usually in combination with [sucrose](#) and glucose. Fructose tautomeric forms are formed as for glucose according to the intramolecular interaction ( $A_N$  mechanism) between electrophilic carbonyl carbon at the C-2 and nucleophilic hydroxyl O at the 5 or 6 carbon atoms:

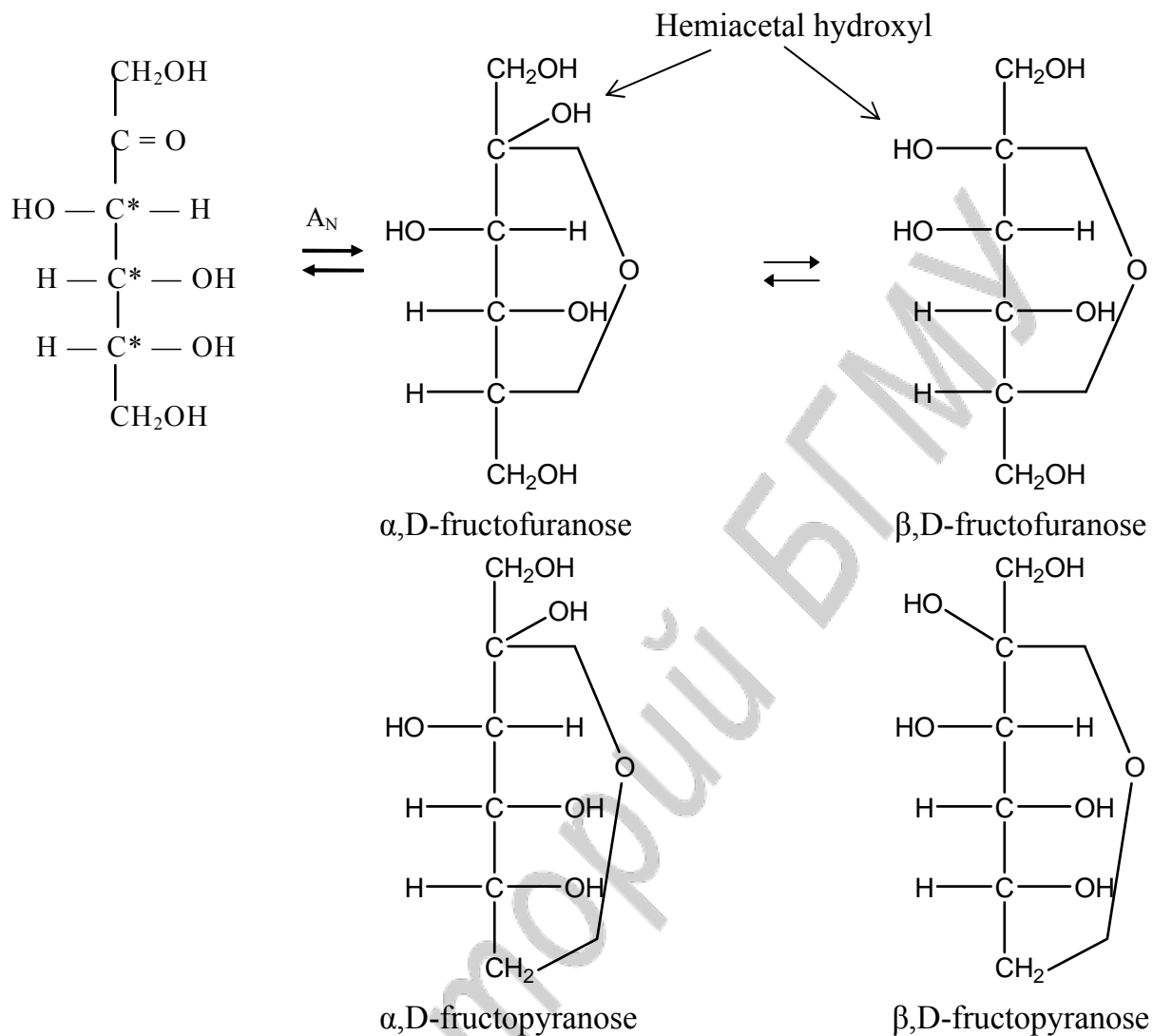

### The Haworth formulas

These formulas use planar hexagon or pentagon to represent the cyclic structures that are pyranose and furanose respectively. The monosaccharide is depicted with the carbon chain horizontally. And the anomeric C-1 atom being to right:

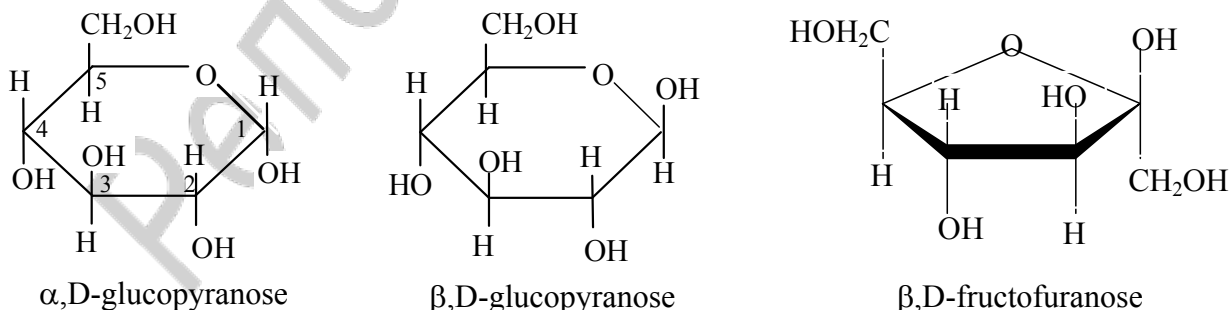

### Monosaccharide conformations

The most real structures for monosaccharides are conformations. The chair conformation (C) is the most favorable one for pyranose cycle and envelope (E) or

twist (T) conformations are for furanose cycle. Let us look at the conformations of  $\alpha$ - and  $\beta$ -glucopyranose.  $\beta$ -glucopyranose have  $-\text{CH}_2\text{OH}$  group and all OH- groups in stable equatorial positions.

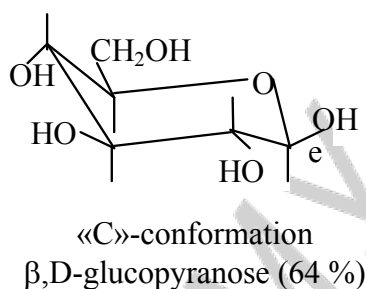
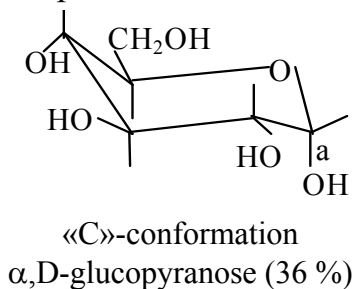

Conformation of monosaccharides is very important for the space structure of polysaccharide chains.

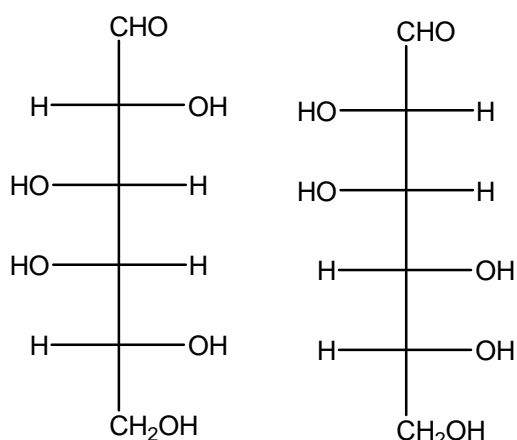

D-Galactose

D- Mannose

### Epimers

Epimers are stereoisomers that differ in configuration at one of the chiral centres (besides anomeric centre) For example, D-glucose epimer on the  $\text{C}_4$  is D-galactose, but on the  $\text{C}_2$  — mannose. They also exist in the tautomeric forms. Epimers can undergo to each other in the alkaline medium by way of endiol form. This process is known as epimerization.

### Pentoses

General formula is  $\text{C}_5\text{H}_8\text{O}_4$ . D-ribose and D-deoxyribose are the most important in the metabolism. D-deoxyribose, unlike ribose, doesn't have OH-group at the second carbon atom. These pentoses exist in the tautomeric forms in the solution.

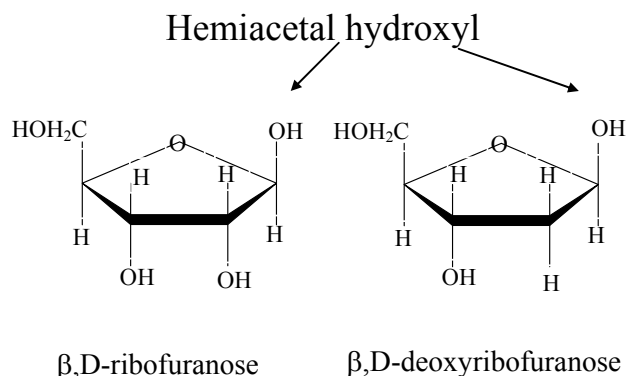
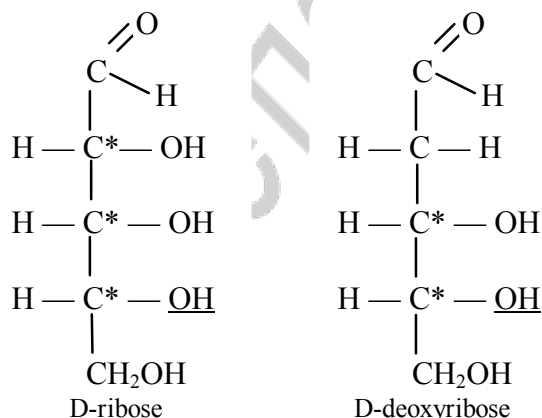

Ribose and deoxyribose  $\beta$ -anomers as «envelop» and «twist» conformers are the parts of nucleic acids as N-glycosides with nitrogen bases.

## Chemical Properties Of Monosaccharides

### Glycosidation reaction

This is a nucleophilic substitution reaction, in which catalyst ( $H^+$ ) converts the OH group at C-1 into a good leaving group (a water molecule). The resulting sugar acetals are called glycosides. They are named from the respective monosaccharides using suffix **-oside**. The bond from C-1 to the OR group of an alcohol is called the *glycosidic bond*. This bond is quite stable in dilute alkaline solutions. The OR unit of the glycoside is called an *aglycone*.

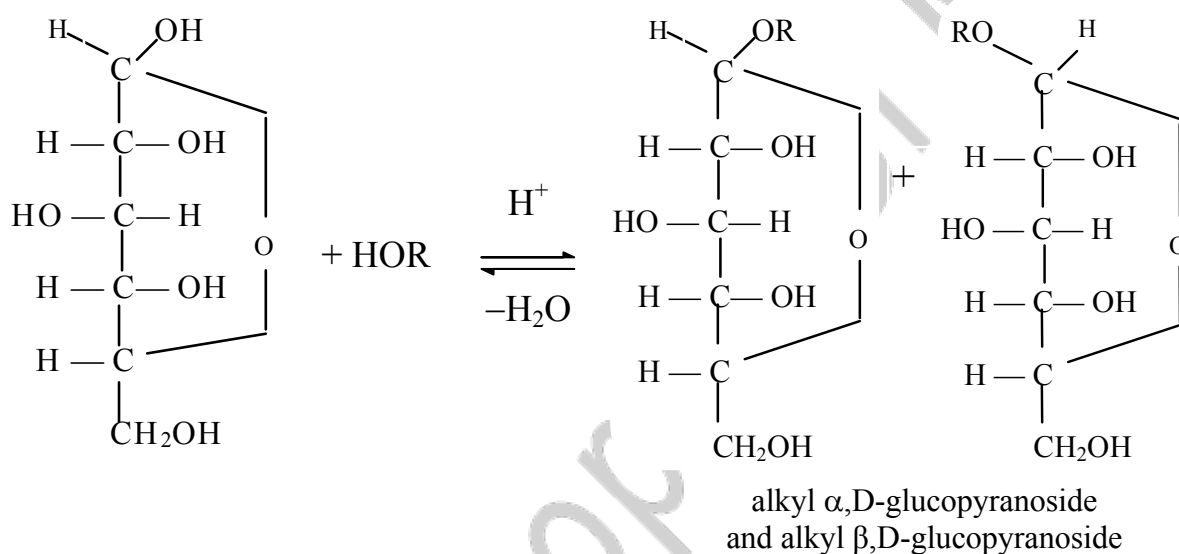

Glycosides formed acting with alcohols, phenols, other monosaccharides and are called O-glycosides. Acting with amines, nitrogen bases (including nucleophiles) N-glycosides are formed.

### Reactions of alcoholic hydroxyls. Ethers and esters formation

Ethers are formed in the reaction of the monose alcoholic OH-groups with acylating agents such as acyl halides (for example, methyl iodide). Further glycoside hydroxyl reacts to form glycoside. Ethers are not hydrolysed and glycoside bond breaks up in the acid medium.

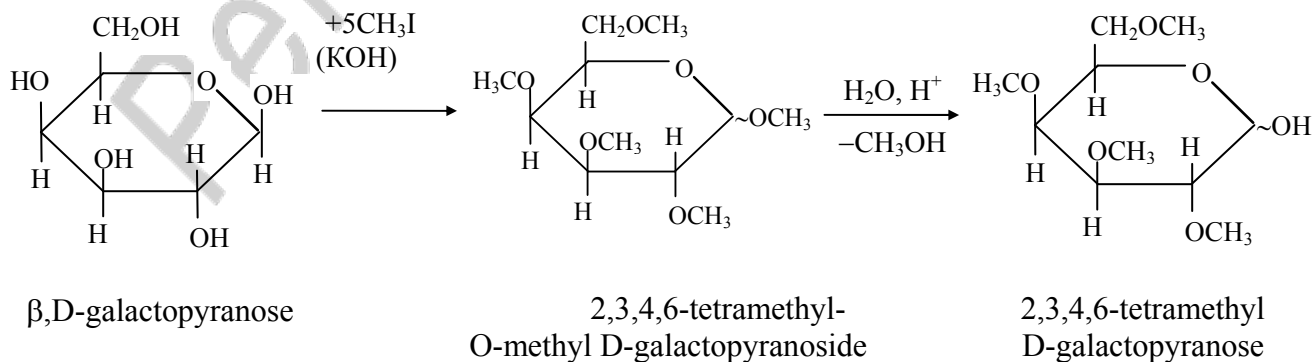

Esters are formed as a result of monosaccharides interaction with acylating agents such as acid anhydrides, for example acetic anhydride. In monosaccharides metabolism sugar phosphates are very important.

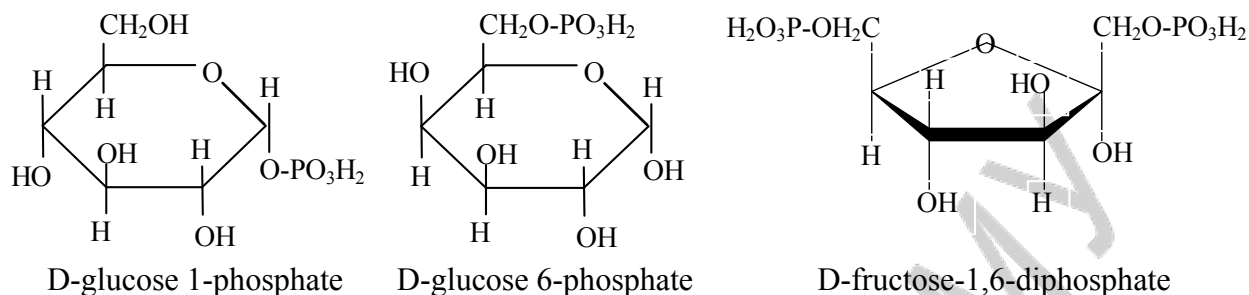

### Oxidation reactions

Such reactions as the silver mirror reaction, the Trommer's test, the Fehling's test are carried out under narrow term i.e. when heated, in the alkaline medium. Acyclic forms of monosaccharides are formed as a result and they then are oxidized. The Fehling's test is the modified reaction of the Trommer's test because the Fehling's reagent is a complex compound of Cu<sup>2+</sup> with K-, Na-tartrates.

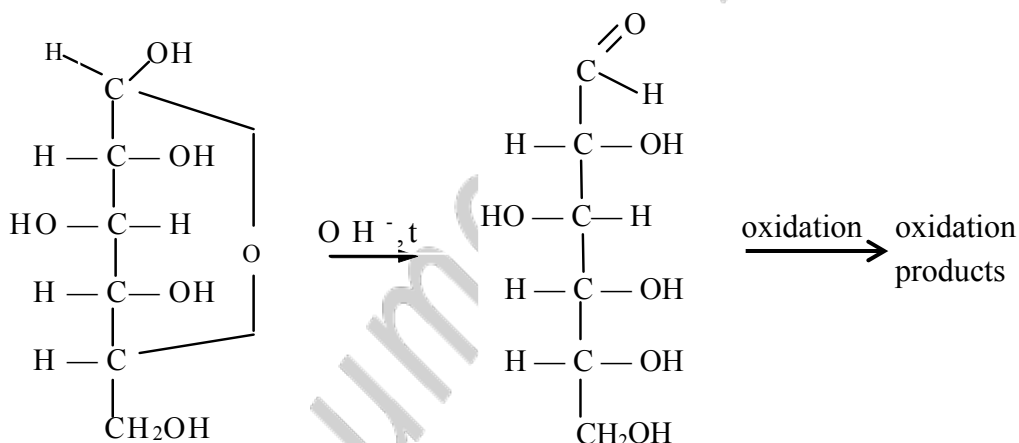

Oxidant such as bromine water is a reagent that selectively oxidized the aldehyde group to carboxylic one. It converts an aldose to an **aldonic acid**.

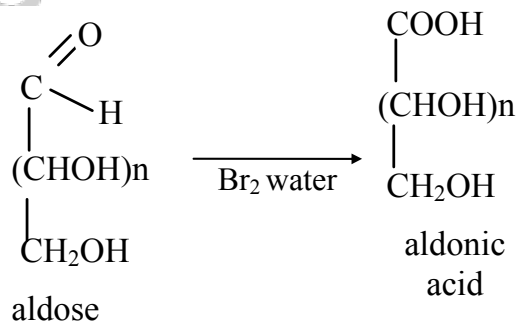

Stronger oxidants such as dilute nitric acid HNO<sub>3</sub> attack both the aldehyde group and the primary alcoholic group of the last C atom to form dicarboxylic acids known as **aldaric acids**.



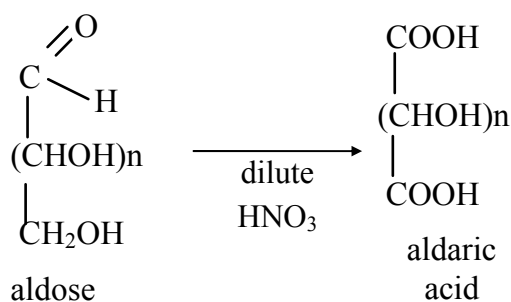

In case when only the aldohexose primary alcoholic group of the last C atom is oxidized **uronic acids** are formed.

At the same time the aldehyde group is protected with transition to glycoside:

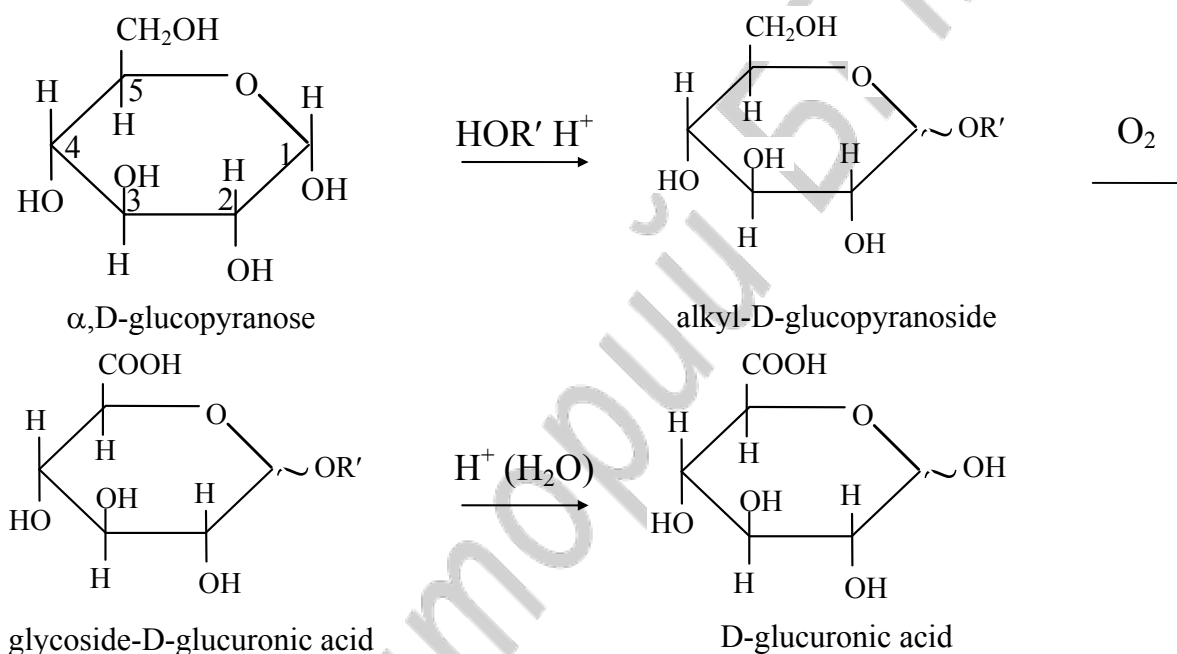

Uronic acids such as glucuronic and galacturonic acids are part of the heteropolysaccharides and participate in detoxication (as bound glycosides and renal [urinary] excretion) of some toxic compounds (phenols, remedies). Uronic acids are decarboxilation inclined and as a result the corresponding pentoses are formed.

### Reduction reactions

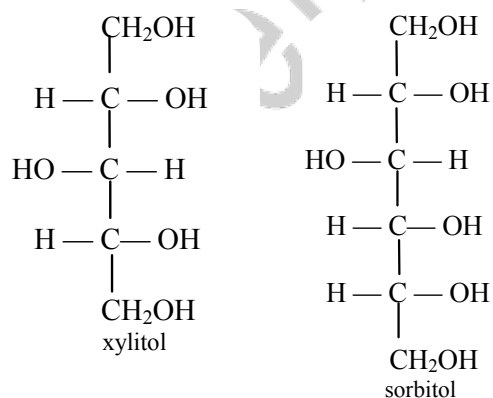

Reduction of the carbonyl group into the CH<sub>2</sub>OH fragment of the monosaccharides gives sugar alcohols called **alditols**.

They are crystal, soluble and have sweet taste. Alditols are used as a sugar substitute for diabetics.

## Monosaccharides Derivatives

### Aminosugars

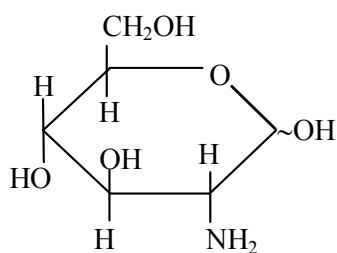

D-glucosamine

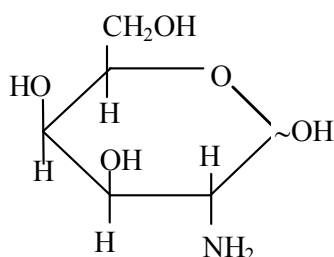

D-galactoseamine

These derivatives containing an amino group (mostly with C<sub>2</sub>) instead of the hydroxyl group possess basic properties.

They are the part of the heteropolysaccharides in which the amino group is acetylated.

### Neuraminic acid

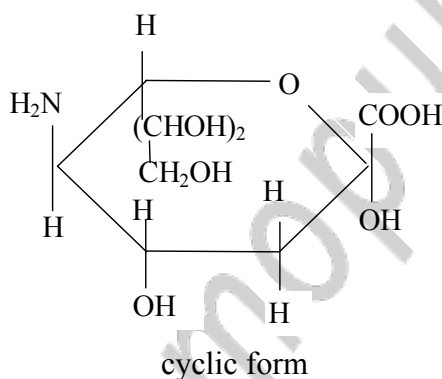
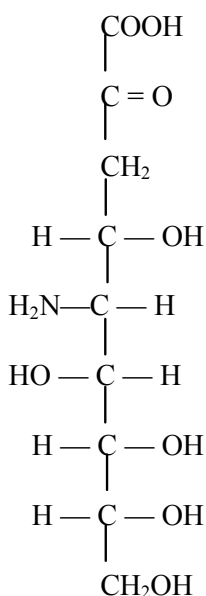

Neuraminic acid carbon chain consists of 9 carbon atoms and contains a ketone group next to carboxyl group. Sialic acids determine cell surface properties. Excess amount of sialic acids on the cell surface explains many properties of the tumorous cells.

N- and O-acylated derivatives of *Neuraminic acid* are called sialic acids. They belong to blood and tissue specific substances and brain gangliosides.

### Ascorbic acid (vitamin C)

Ascorbic acid is similar to a monosaccharide structure and represents  $\gamma$ -lacton 2-oxo-L-gulonic acid. It shows quite strong acidic properties ( $pK_a = 4,2$ ) provided with by endiol fragment OH-groups.

Ascorbic acid is produced by plants and animals except guinea-pigs, some birds, monkeys and humans. Therefore ascorbic acid must be received with nutrients (75 mg in amount). Vitamin C is water soluble antioxidant. It is necessary to produce collagen. In case of collagen sufficiently scurvy develops.

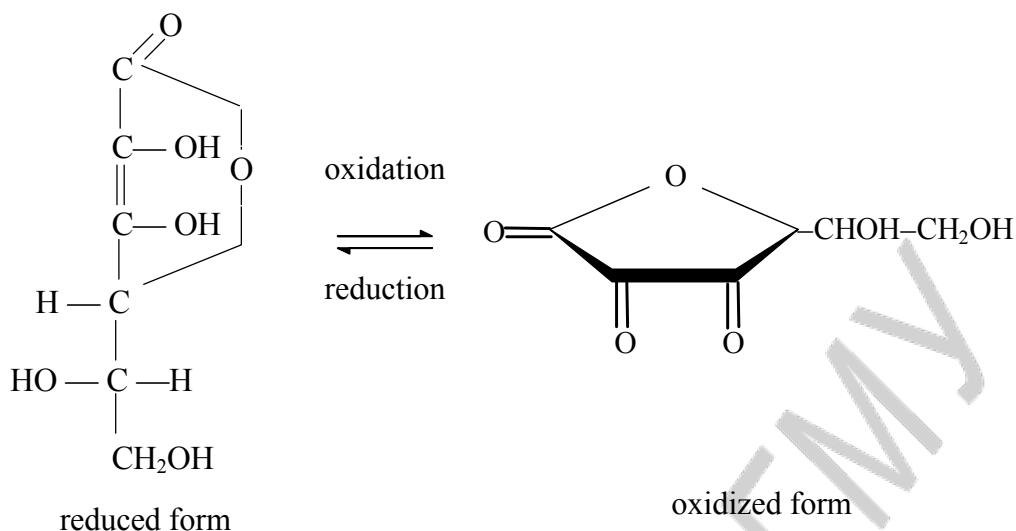

## Polysaccharidies: Structure, Biological Role

### Disaccharides

Ordinary table sugar is disaccharide called **sucrose**. Sucrose, the most widely occurring disaccharide, is found in all photosynthetic plants. Sucrose ( $\alpha$ ,D-glucopyranosyl- $\beta$ ,D-fructofuranoside) has the structure shown in the figure.

The structure of sucrose is based on the following evidence:

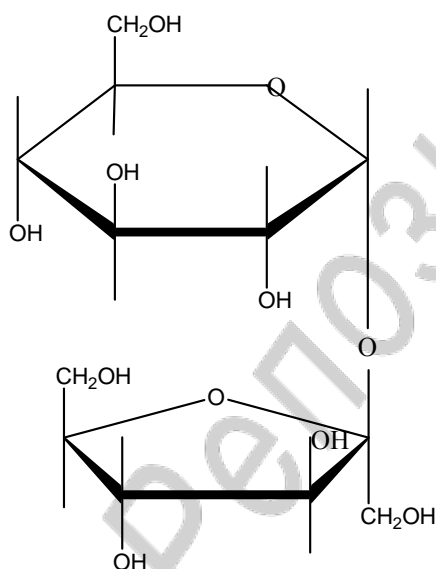

1. Sucrose has the molecular formula  $\text{C}_{12}\text{H}_{22}\text{O}_{11}$ .
2. Acid-catalyzed hydrolysis of 1 mol of sucrose yields 1 mol of D-glucose and 1 mol of D-fructose.
3. Sucrose is a nonreducing sugar; it gives negative tests with Tollens' solutions. Sucrose does not undergo mutarotation. These facts mean that neither the glucose nor the fructose portion of sucrose has a hemiacetal group. Thus, the two hexoses must have a glycoside linkage that involves C-1 of glucose and C-2 of fructose, for only in this way will both carbonyl groups be present as full acetals (i. e., as glycosides).

The structure of sucrose has been confirmed by the X-ray analysis and by an unambiguous synthesis.

**Maltose** is disaccharide, composed of two  $\alpha$ ,D-glucopyranose residues.

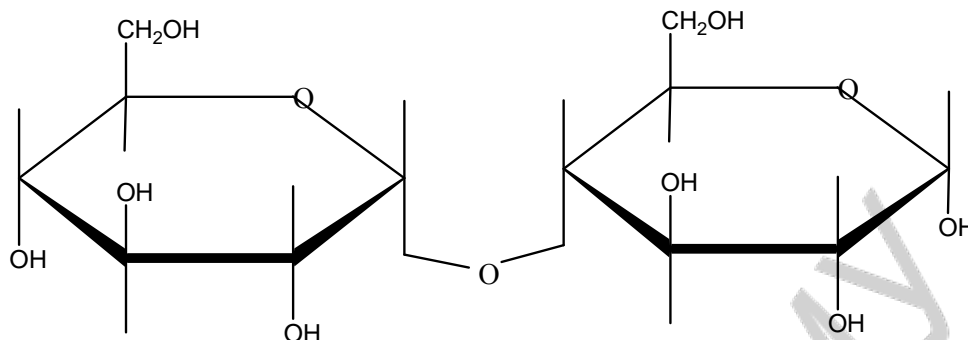

When 1 mol of maltose is subjected to acid-catalyzed hydrolysis, it yields 2 mol of D-glucose. Unlike sucrose, maltose is a reducing sugar; it gives positive tests with Fehling's, and Tollens' solutions. Maltose exists in two anomeric forms:  $\alpha$ -maltose, and  $\beta$ -maltose. The maltose anomers undergo mutarotation to yield an equilibrium mixture.

One of the glucose residues of maltose is present in a hemiacetal form, therefore, must be present as a glucoside. Maltose reacts with bromine water to form a monocarboxylic acid, maltonic acid.

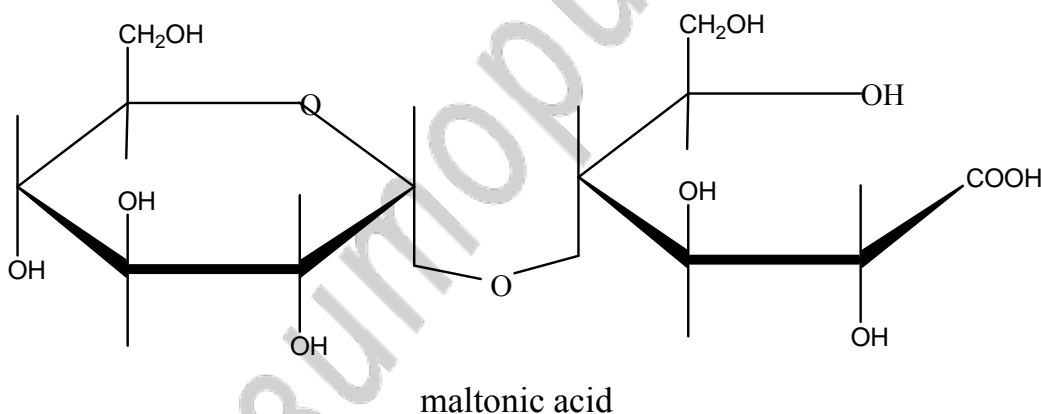

This fact, too, is consistent with the presence of only one hemiacetal group.

**Cellobiose** also consists of two glucose residues. Partial hydrolysis of cellulose gives the disaccharide cellobiose. Cellobiose resembles maltose in every respect except one: the configuration of its glycosidic linkage.

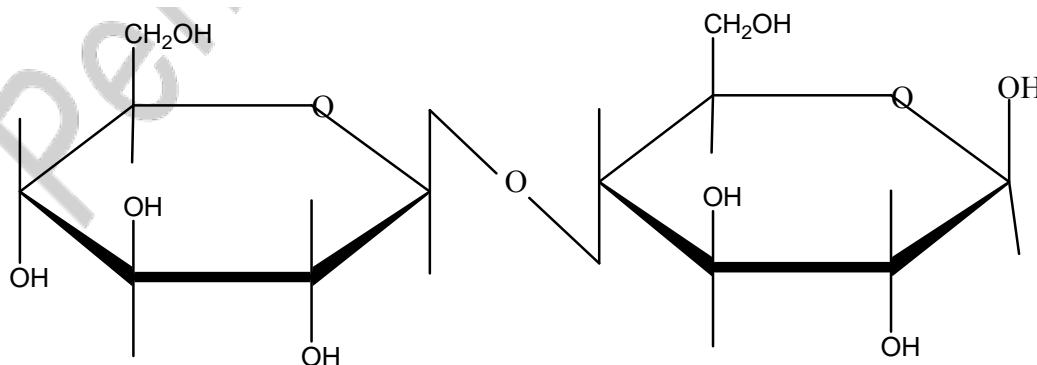

cept one: the configuration of its glycosidic linkage.

This is  $\beta$ -anomer of cellobiose. Cellobiose, like maltose, is a reducing sugar that, on acid-catalyzed hydrolysis, yields two molar equivalents of D-glucose. Cellobiose also undergoes mutarotation. However, unlike maltose, cellobiose is hydrolyzed by  $\beta$ -glucosidases and not by  $\alpha$ -glucosidases, which indicates that the glycosidic linkage in cellobiose is  $\beta$ .

**Lactose** is a disaccharide present in the milk of humans, cows, and almost all other mammals. Lactose is a reducing sugar that hydrolyzes to yield D-glucose and D-galactose; the glycosidic linkage is  $\beta$ .

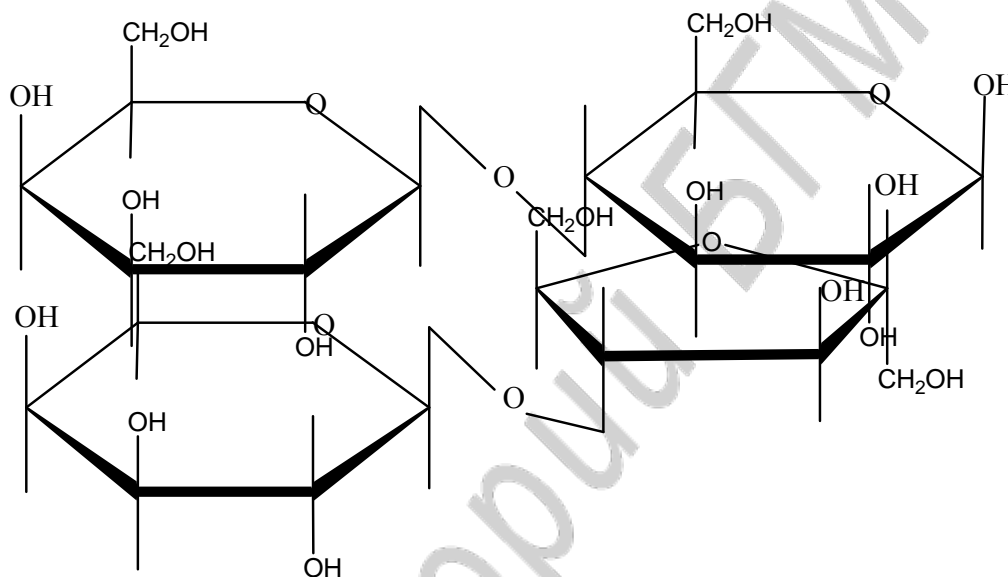

**Lactulose** is a synthetic sugar used in the treatment of constipation and hepatic encephalopathy, a complication of liver disease. It is a disaccharide formed from one molecule each of the simple sugars (monosaccharides) fructose and galactose. The type of bond is  $\beta(1 \rightarrow 4)$ . The commercial syrup used for treatment of constipation is dyed yellow-orange. It is produced commercially by isomerization of lactose.

### Polysaccharides

Polysaccharides, also known as **glycans**, consist of monosaccharides joined together by glycosidic linkages. Polysaccharides that are polymers of a single monosaccharide are called homopolysaccharides; those made up of more than one type of monosaccharide are called heteropolysaccharides. Homopolysaccharides are also classified on the basis of their monosaccharide units. A homopolysaccharide consisting of glucose monomeric units is called a glucan; one consisting of galactose units is a galactan, and so on.

Three important polysaccharides are starch, glycogen and cellulose. They are all glucans. Starch is the principal food reserve of plants; glycogen functions as

a carbohydrate reserve for animals; and cellulose serves as structural material in plants. Examining the structures of these three polysaccharides, we shall be able to see how each is especially suited for its function.

## Starch

Starch occurs as microscopic granules in the roots, tubers, and seeds of plants. Corn, potatoes, wheat, and rice are important commercial sources of starch. Heating starch with water causes the granules to swell and produce a colloidal suspension from which two major components can be isolated. One fraction is called amylose and the other amylopectin. Most starches yield 10–20 % **amylose** and 80–90 % **amylopectin**.

Physical measurements show that amylose typically consists of more than 1000 D-glucopyranoside units connected in a linkages between C-1 of one unit and C-4 of the next. Thus, in the ring size of its glucose units and in the configuration of the gly-

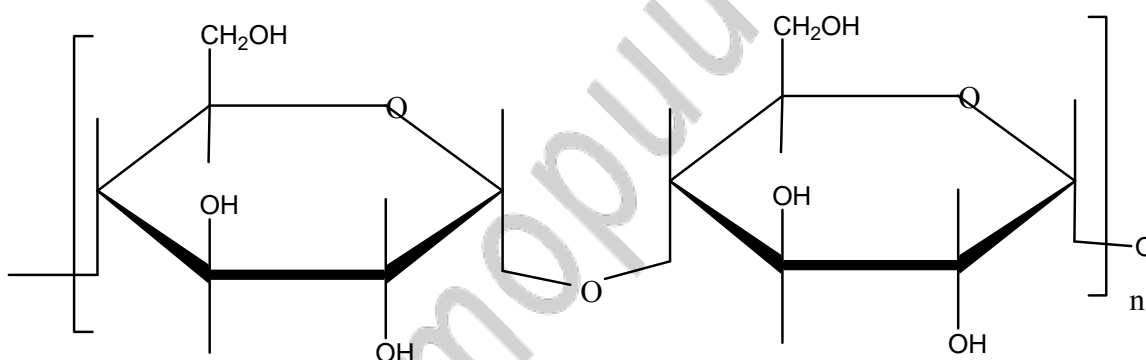

cosidic linkages between them, amylose resembles maltose.

Chains of D-glucose units with  $\alpha$ -glycosidic linkages such as those of amylose tend to assume a helical arrangement. This arrangement results in a compact shape for the amylose molecule even though its molecular weight is quite large (150,000–600,000).

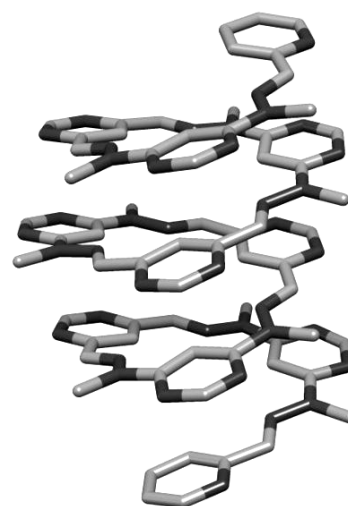

Amylopectin has a structure similar to that of amylose (i. e.,  $\alpha$ , 1 $\rightarrow$ 4 links), with the exception of the fact that in amylopectin the chains are branched. Branching takes place between C-6 of one glucose unit and C-1 of another and occurs at intervals of 20–25 glucose units. Physical measurements indicate that amylopectin consists of hundreds of interconnecting chains of 20–25 glucose units each.

Starch is by far the most consumed polysaccharide in the human diet. Tradi-

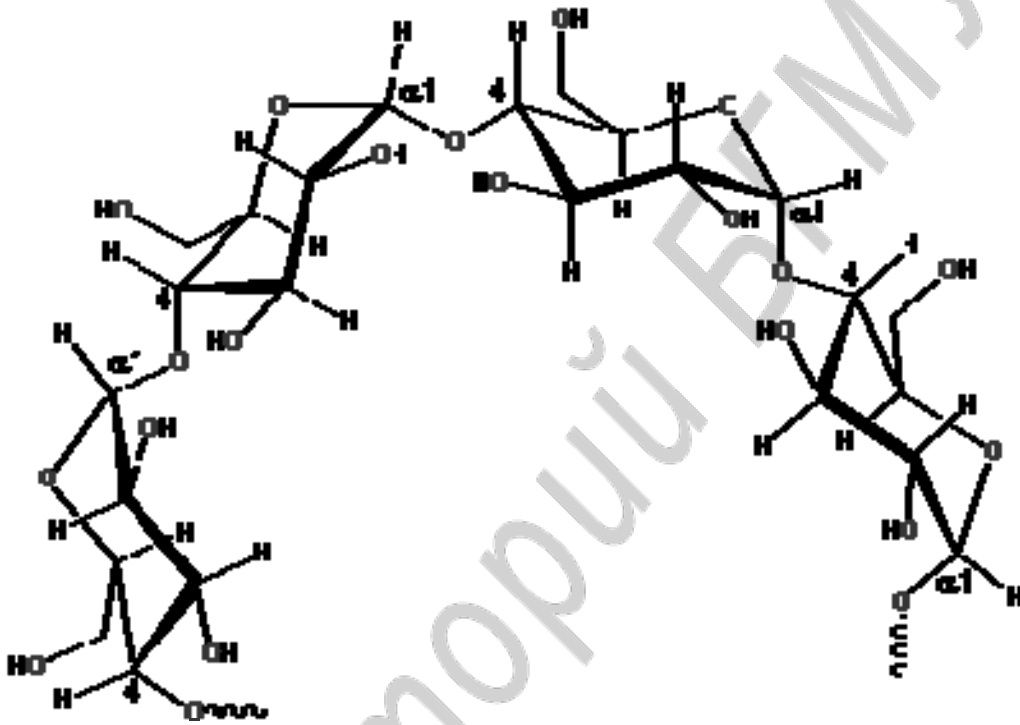

tional staple foods such as [cereals](#), roots and [tubers](#) are the main source of dietary starch.

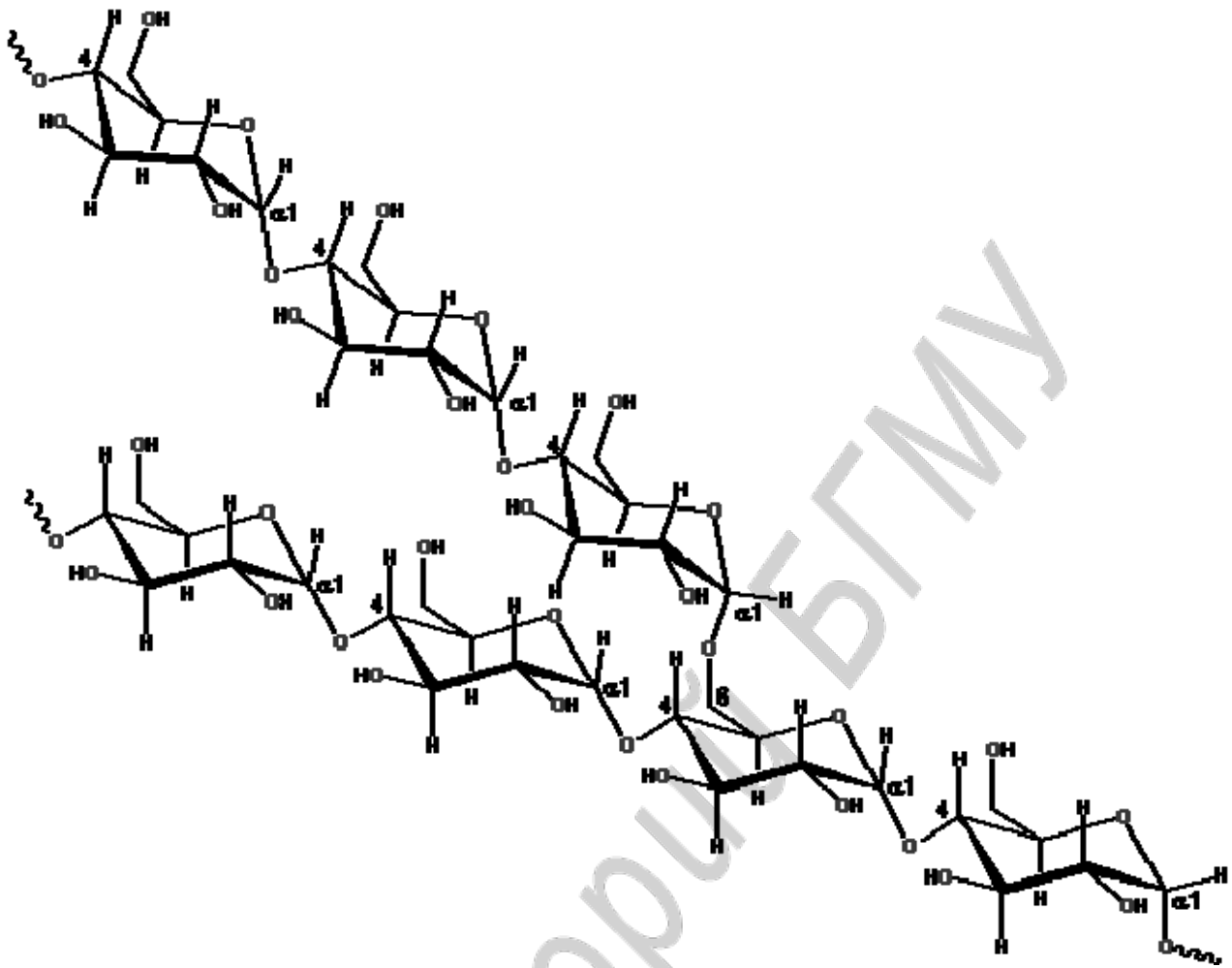

**Glycogen**

Glycogen has a structure very much similar to that of amylopectin; however, in glycogen the chains are much more highly branched. Methylation and hydrolysis of glycogen indicates that there is one end group for every 10–12 glucose units; branches may occur as often as every 6. Glycogen has a very high molecular weight.

The size and the structure of glycogen beautifully suit its function as reserve carbohydrate for animals. First, its size makes it too large to diffuse across cell membranes: thus, glycogen remains inside the cell where it is needed as an energy source. Because glycogen is so highly branched, a very large number of end groups are available at which these enzymes can operate. At the same time the overall concentration of glycogen (in moles per liter) is quite low because of its enormous molecular weight.

### **Cellulose**

When we examine the structure of cellulose, we find another example of a polysaccharide in which nature has arranged monomeric glucose units in a manner that suits its function. Cellulose contains D-glucopyranoside units linked in 1→4



fashion in very long unbranched chains. Unlike starch and glycogen, however, the linkages in cellulose are  $\beta$ -glycosidic ones.

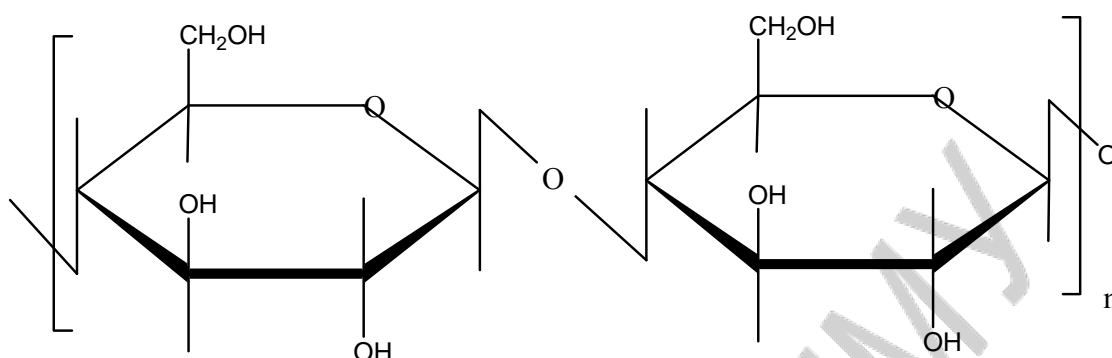

This configuration of the anomeric carbon atoms of cellulose makes cellulose chains essentially linear. The linear arrangement of  $\beta$ -linked glucose units in cellulose presents a uniform distribution of  $-\text{OH}$  groups on the outside of each chain. When two or more cellulose chains make contact, the hydroxyl groups are ideally situated to "zip" the chains together by forming hydrogen bonds.

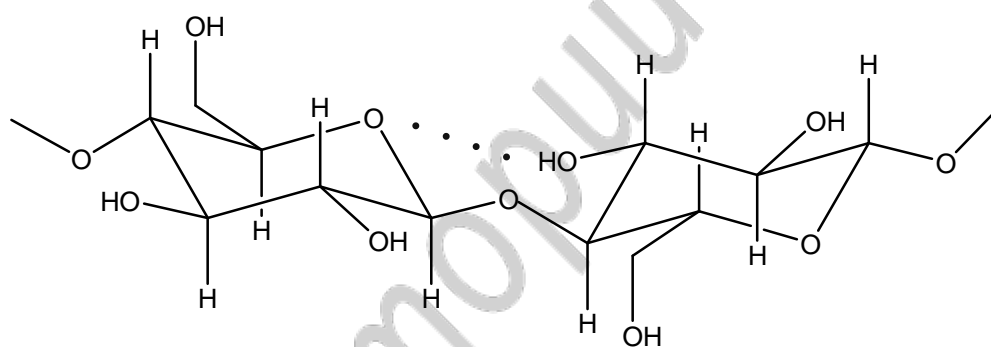

Zippering many cellulose chains together in this way gives a highly insoluble, rigid, and fibrous polymer that is ideal as cell-wall material for plants.

**Dextran** is a complex, branched [glucan](#) made of many [glucose](#) molecules joined into chains of varying lengths (from 10 to 150 [kilodaltons](#)), used as an [antithrombotic](#) (anti-[platelet](#)), and to reduce blood [viscosity](#). The straight chain consists of  $\alpha,1\rightarrow6$  [glycosidic](#) linkages between glucose molecules, while branches begin from  $\alpha,1\rightarrow4$  linkages (and in some cases,  $\alpha,1\rightarrow2$  and  $\alpha,1\rightarrow3$  linkages as well).

Dextran is synthesized from sucrose by certain lactic-acid bacteria, the best-known being *Leuconostoc mesenteroides* and *Streptococcus mutans*. Dental plaque

is rich in dextrans. Dextran is also formed by the probiotic *Lactobacillus brevis* to create the crystals of tibicos, or water kefir fermented beverage with reported health benefits.

Dextrans can be used as plasma expanders (substitutes for whole blood) in cases of severe shock. In addition, a dextran derivative compound is employed medi-

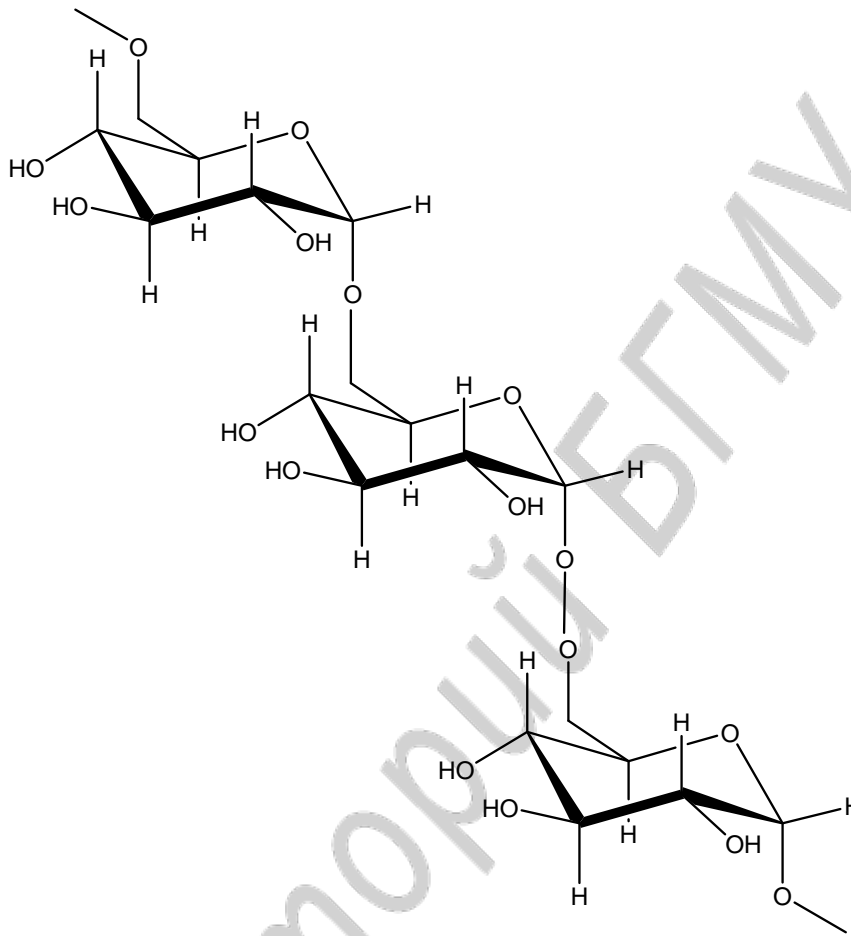

cally as an anticoagulant for blood.

### Heteropolysaccharides

**Hyaluronic acid** is a non-sulfated [glycosaminoglycan](#) distributed widely throughout [connective](#), [epithelial](#), and [neural tissues](#). It is one of the chief components of the extracellular matrix, contributes significantly to cell proliferation and migration. Hyaluronic acid is an important component of articular [cartilage](#), where it is present as a coat around each cell ([chondrocyte](#)). When [aggrecan](#) monomers bind to hyaluronan in the presence of [link protein](#), large highly negatively-charged aggregates form. These aggregates imbibe water and are responsible for the [resilience](#) of [cartilage](#) (its resistance to compression). The [molecular weight](#) (size) of hyaluronic acid in [cartilage](#) decreases with age, but the amount increases. Hyaluronic acid is also a major component of [skin](#), where it is involved in tissue repair.

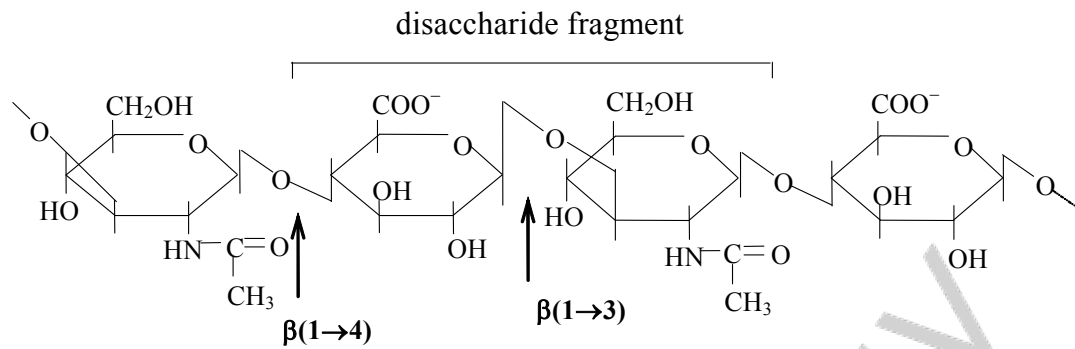

Hyaluronic acid is a polymer of disaccharides, themselves composed of D-glucuronic acid and D-N-acetylglucosamine, linked together via alternating  $\beta$ -1,4 and  $\beta$ -1,3 glycosidic bonds.

**Chondroitin sulfate** is a sulfated glycosaminoglycan composed of a chain of alternating sugars (N-acetylgalactosamine and glucuronic acid). It is usually found attached to proteins as part of a proteoglycan. A chondroitin chain can have over 100 individual sugars, each of which can be sulfated in variable positions and quantities. Chondroitin sulfate is an important structural component of cartilage and provides much of its resistance to compression.

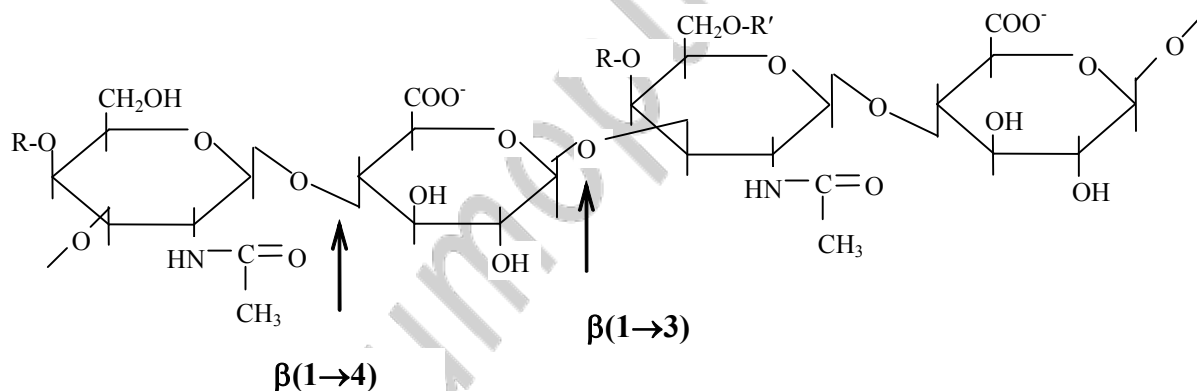

Chondroitin sulfate was originally isolated well before the structure was characterised, leading to changes in terminology with time. Early researchers identified different fractions of the substance with letters.

Letter identification	Site of sulfation	Systematic name
Chondroitin sulfate A	carbon 4 of the N-acetylgalactosamine (GalNAc) sugar	chondroitin-4-sulfate
Chondroitin sulfate C	carbon 6 of the GalNAc sugar	chondroitin-6-sulfate
Chondroitin sulfate D	carbon 2 of the glucuronic acid and 6 of the GalNAc sugar	chondroitin-2,6-sulfate
Chondroitin sulfate E	carbons 4 and 6 of the GalNAc sugar	chondroitin-4,6-sulfate

Although the name "chondroitin sulfate" suggests a salt with a sulfate counter-anion, this is not the case, as sulfate is covalently attached to the sugar. Rather, since the molecule has multiple negative charges at physiological pH, a cation is present in salts of chondroitin sulfate. Commercial preparations of chondroitin sulfate typically are the sodium salt. Barnhill et al. have suggested that all such preparations of chondroitin sulfate be referred to as "sodium chondroitin" regardless of their sulfation status. Chondroitin sulfate chains are unbranched polysaccharides of variable length containing two alternating monosaccharides: D-glucuronic acid (GlcA) and N-acetyl-D-galactosamine (GalNAc). Some GlcA residues are epimerized into L-iduronic acid (IdoA); the resulting disaccharide is then referred to as dermatan sulfate. Chondroitin sulfate chains are linked to hydroxyl groups on serine residues of certain proteins.

**Attachment of the glycosaminoglycan chain begins with four monosaccharides in a fixed pattern: Xyl – Gal – Gal – GlcA. Each sugar is attached by a specific enzyme, allowing for multiple levels of control over glycosaminoglycan synthesis.**

**Each monosaccharide may be left unsulfated, sulfated once, or sulfated twice. Most commonly the hydroxyls of the 4 and 6 positions of the N-acetyl-galactosamine are sulfated, with some chains having the 2 position of glucuronic acid.**

Chondroitin sulfate is a major component of extracellular matrix, and is important in maintaining the structural integrity of the tissue. This function is typical of the large aggregating proteoglycans: aggrecan, versican, brevican, and neurocan, collectively termed the lecticans.

## Structure And Reactivity Of Amino Acids Acting As A Heterofunctional Compounds

There are about 300 amino acids in nature, but only 20 of them are found in the protein structure. They are called proteinogenic amino acids (or  $\alpha$ -amino acids).  $\alpha$ -Amino acids are the most important in biological processes being the building blocks of proteins. Recall that  $\alpha$ -amino acids are carboxylic acids with an amino group attached to the  $\alpha$ -carbon atom; they may be represented by the general formula:

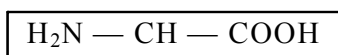

|

R

In other words, all  $\alpha$ -amino acids possess three common features:

1. They have an  $\alpha$ -carboxyl group. The  $\alpha$  denotes that this group binds to the central or  $\alpha$ -carbon atom, which is asymmetric.
2. They possess an  $\alpha$ -amino group.
3. They contain a side chain, or an R group, that is bound to the  $\alpha$ -carbon.

We will discuss only  $\alpha$ -amino acids so the symbol  $\alpha$  we will further omit. Amino acids are known by their trivial names, which are accepted by the IU nomenclature. This table illustrates 20 amino acids. They also have a three-letter abbreviation and one-letter abbreviation (mostly the three letters are used), which are useful for writing the formulas of peptides and proteins.

The full systematic forms ethanoic, propanoic, butanoic and pentanoic may alternatively be called acetic, propionic, butyric and valeric, respectively. Similarly, butanedioic = succinic, 3-carbamoylpropanoic = succinamic, pentanedioic = glutaric, and 4-carbamoylbutanoic = glutaramic. One of the most striking and significant properties of amino acids is their chirality, or handedness. The word chiral is related to the Greek word meaning hand. Just as the right hand is related to the left hand by a mirror image, so, in general, naturally occurring amino acids are related to a stereoisomer by its mirror image.

Trivial name	Symbols	Systematic name	Formula
Alanine	Ala A	2-aminopropanoic acid	$\begin{array}{c} \text{H}_2\text{N}-\text{CH}-\text{COOH} \\   \\ \text{CH}_3 \end{array}$
Arginine	Arg R	2-amino-5-guanidinopentanoic acid	$\begin{array}{c} \text{H}_2\text{N}-\text{CH}-\text{COOH} \\   \\ \text{CH}_2 \\   \\ \text{CH}_2 \\   \\ \text{CH}_2 \\   \\ \text{NH} \\   \\ \text{C}=\text{NH} \\   \\ \text{NH}_2 \end{array}$

Trivial name	Symbols	Systematic name	Formula
Asparagine	Asn N	2-amino-3-carbamoylpropanoic acid	$\begin{array}{c} \text{H}_2\text{N}-\text{CH}-\text{COOH} \\   \\ \text{CH}_2 \\   \\ \text{C}=\text{O} \\   \\ \text{NH}_2 \end{array}$
Aspartic acid	Asp D	2-aminobutanedioic acid	$\begin{array}{c} \text{H}_2\text{N}-\text{CH}-\text{COOH} \\   \\ \text{CH}_2 \\   \\ \text{COOH} \end{array}$
Cysteine	Cys C	2-amino-3-mercaptopropanoic acid	$\begin{array}{c} \text{H}_2\text{N}-\text{CH}-\text{COOH} \\   \\ \text{CH}_2 \\   \\ \text{SH} \end{array}$
Glutamine	Gln Q	2-amino-4-carbamoylbutanoic acid	$\begin{array}{c} \text{H}_2\text{N}-\text{CH}-\text{COOH} \\   \\ \text{CH}_2 \\   \\ \text{CH}_2 \\   \\ \text{C}=\text{O} \\   \\ \text{NH}_2 \end{array}$
Glutamic acid	Glu E	2-aminopentanedioic acid	$\begin{array}{c} \text{H}_2\text{N}-\text{CH}-\text{COOH} \\   \\ \text{CH}_2 \\   \\ \text{CH}_2 \\   \\ \text{COOH} \end{array}$
Glycine	Gly G	aminoethanoic acid	$\begin{array}{c} \text{H}_2\text{N}-\text{CH}-\text{COOH} \\   \\ \text{H} \end{array}$
Histidine	His H	2-amino-3-(1 <i>H</i> -imidazol-4-yl)-propanoic acid	$\begin{array}{c} \text{H}_2\text{N}-\text{CH}-\text{COOH} \\   \\ \text{CH}_2 \\   \\ \text{Imidazole ring} \end{array}$
Isoleucine	Ile I	2-amino-3-methylpentanoic acid	$\begin{array}{c} \text{H}_2\text{N}-\text{CH}-\text{COOH} \\   \\ \text{CHCH}_3 \\   \\ \text{CH}_2 \\   \\ \text{CH}_3 \end{array}$
Leucine	Leu L	2-amino-4-methylpentanoic acid	$\begin{array}{c} \text{H}_2\text{N}-\text{CH}-\text{COOH} \\   \\ \text{CH}_2 \\   \\ \text{CHCH}_3 \\   \\ \text{CH}_3 \end{array}$
Lysine	Lys K	2,6-diaminohexanoic acid	$\begin{array}{c} \text{H}_2\text{N}-\text{CH}-\text{COOH} \\   \\ \text{CH}_2 \\   \\ \text{CH}_2 \\   \\ \text{CH}_2 \\   \\ \text{CH}_2 \\   \\ \text{NH}_2 \end{array}$
Methionine	Met M	2-amino-4-(methylthio)butanoic acid	$\begin{array}{c} \text{H}_2\text{N}-\text{CH}-\text{COOH} \\   \\ \text{CH}_2 \\   \\ \text{CH}_2 \\   \\ \text{S} \\   \\ \text{CH}_3 \end{array}$

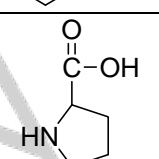
Trivial name	Symbols	Systematic name	Formula
Phenylalanine	Phe F	2-amino-3-phenylpropanoic acid	$\begin{array}{c} \text{H}_2\text{N}-\text{CH}-\text{COOH} \\   \\ \text{CH}_2 \\   \\ \text{C}_6\text{H}_5 \end{array}$
Proline	Pro P	pyrrolidine-2-carboxylic acid	
Serine	Ser S	2-amino-3-hydroxypropanoic acid	$\begin{array}{c} \text{H}_2\text{N}-\text{CH}-\text{COOH} \\   \\ \text{CH}_2 \\   \\ \text{OH} \end{array}$
Threonine	Thr T	2-amino-3-hydroxybutanoic acid	$\begin{array}{c} \text{H}_2\text{N}-\text{CH}-\text{COOH} \\   \\ \text{CHOH} \\   \\ \text{CH}_3 \end{array}$
Tryptophan	Trp W	2-amino-3-(1 <i>H</i> -indol-3-yl)-propanoic acid	$\begin{array}{c} \text{H}_2\text{N}-\text{CH}-\text{COOH} \\   \\ \text{CH}_2 \\   \\ \text{Indole} \end{array}$
Tyrosine	Tyr Y	2-amino-3-(4-hydroxyphenyl)-propanoic acid	$\begin{array}{c} \text{H}_2\text{N}-\text{CH}-\text{COOH} \\   \\ \text{CH}_2 \\   \\ \text{C}_6\text{H}_4 \\   \\ \text{OH} \end{array}$
Valine	Val V	2-amino-3-methylbutanoic acid	$\begin{array}{c} \text{H}_2\text{N}-\text{CH}-\text{COOH} \\   \\ \text{CHCH}_3 \\   \\ \text{CH}_3 \end{array}$

The chirality of amino acid stems from the chiral, or asymmetric, center, the  $\alpha$ -C atom. The  $\alpha$ -C atom is a chiral center if it is connected to four different substituents. Thus glycine has no chiral center. Two of the amino acids, isoleucine and threonine, possess additional chiral centers because each has one additional asymmetric carbon.

Stereoisomers are compounds that have the same order of atom attachment, but differ only in the arrangement of their atoms or groups in space. Two structures that constitute a stereoisomeric pair are referred to as enantiomers. An object and its non-superposable mirror image are called enantiomers.

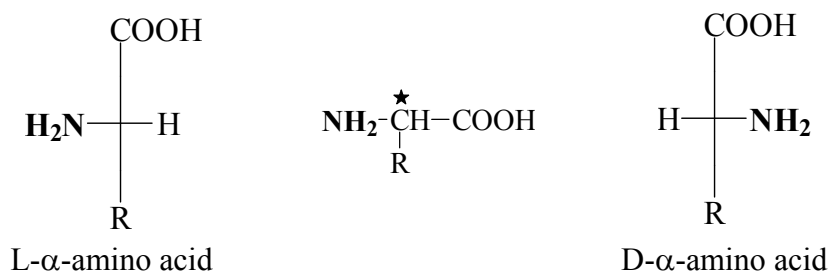

Thus two-dimensional formulas are called Fischer projection formulas, or simply Fischer projections.

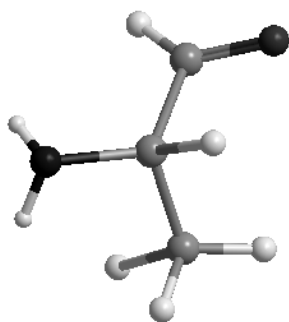

Let us look at three-dimensional formula of L-alanine in figure.

L-amino acids are found in the animal proteins, D-amino acids are in the microorganism proteins and peptides. D-amino acids aren't assimilated by human organism.

Due to the R, S-nomenclature the most of natural amino acids have S-configuration.

The figure above illustrates the spatial formula (or stereochemical formula) of L-alanine. The sign (-) means that amino acid rotates the light counterclockwise.

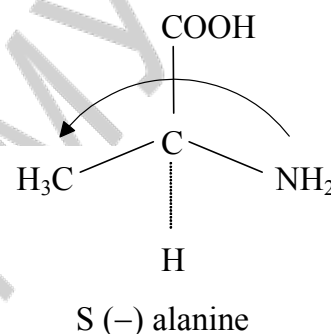

### **Classification of biogenic amino acids according to acid-base properties and nature of the radical. Essential amino acids**

There are several classifications of biogenic amino acids:

- Based on acid-base groups (neutral, acidic, or basic). Most amino acids have the neutral radicals. Among acidic amino acids we can define aspartic and glutamic acids that have the extra carboxyl group.

Among basic amino acids we can define three compounds (lysine, arginine, and histidine) that have an extra basic function in the side chains.

- Based on presence of another functional groups and radicals (these are aliphatic, aromatic (phenylalanine and tyrosine), heterocyclic, hydroxyl-containing, and sulfur-containing amino acids).

- Based on R's nature, polarity and ionization ability (amino acids with hydrophobic and hydrophilic Rs).

From a biological point of view, essential amino acids stand out because they, in contrast to other amino acids, cannot be synthesized in sufficient quantity by adult humans and therefore must be obtained from dietary sources.

The lack of some essential amino acids in the diet can lead to severe deficiency diseases. These amino acids are the following: Arg, Val, His, Ileu, Leu, Lis, Met, Thre, Try, Phe. But Arg and His are proved to be replaceable for adult human.



## Reactions of amino acids on carboxylic group (-COOH)

Etherification reaction (esters formation) is the following:

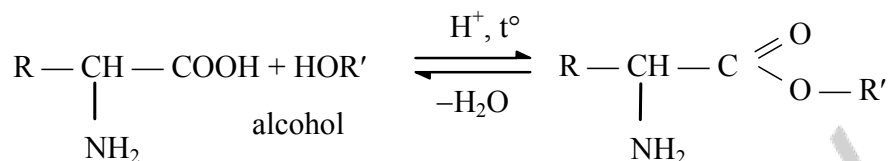

As an acidic catalyst *n*-toluene sulfonic acid is used and converts an amino acid into the protonated (cationic) form. This reaction is used for protection of carboxylic group in peptide synthesis.

Amino acid esters, in contrast to amino acids themselves, are relatively volatile derivatives that can be distilled (sometimes in vacuum). This property is used in the analysis of amino acid mixtures. Besides, amino acid esters are important intermediates in peptides synthesis.

A reaction with phosphorus halogenides ( $\text{PCl}_5$ ,  $\text{PCl}_3$ ) or thionylchloride ( $\text{SOCl}_2$ ) is presented in such a way:

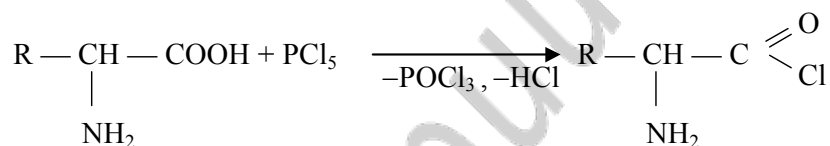

This reaction is used for the protection of a carboxylic group in peptide synthesis.

## Reactions of amino acids on amino group (-NH<sub>2</sub>)

Most of carbonyl compounds react with the amino group of an amino acid giving the Schiff's bases. Such derivatives of some amino acids can be analyzed by spectral methods.

Reaction with formaldehyde

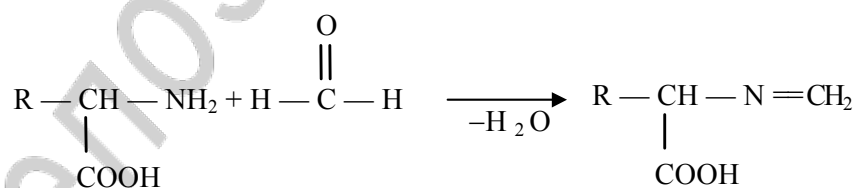

This reaction is the basis of AA quantity Formalin titration with alkali on Sersen method.

Reaction with nitrous acid. Amino acids react with nitrous acid,  $\text{HNO}_2$ , producing alcohols and molecular nitrogen:

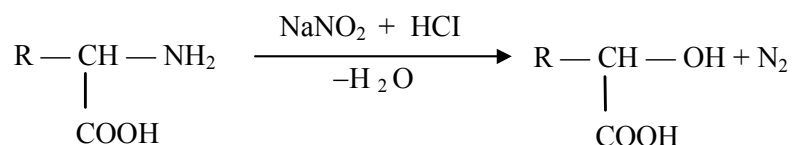

Measuring the volume of the nitrogen evolved it is possible to determine the quantity of amino groups in the tested sample of an amino acid. The reaction is a background of the Van Slyke method.

Acidation reaction with acetic anhydride is used for protection amino groups in the peptide synthesis.

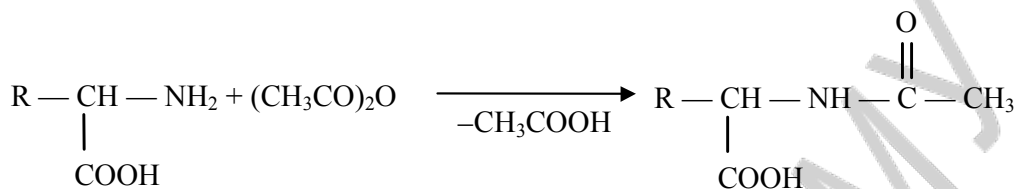

### Amphoteric properties of amino acids, influence of pH medium on acid-base properties of amino acids

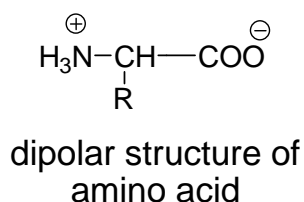

Amino acids have a dipolar ion structure, called **zwitterion** (from the German Zwitter — hybrid), since they contain both an acidic group (COOH) and a basic group (NH<sub>2</sub>) within the same molecule.

Amino acids are crystalline compounds with high melting points (ranging from 220 to 340 °C) and are much better soluble in water than in organic solvents. The predominant form of an amino acid in the solution depends on the pH of the solution and on the nature of the amino acid (i. e. the R group in the general formula). In strongly acidic solutions (pH < 2) all amino acids exist mainly as cations; in strongly basic solutions (pH > 12) they are presented as anions:

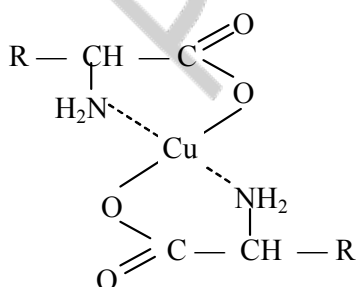
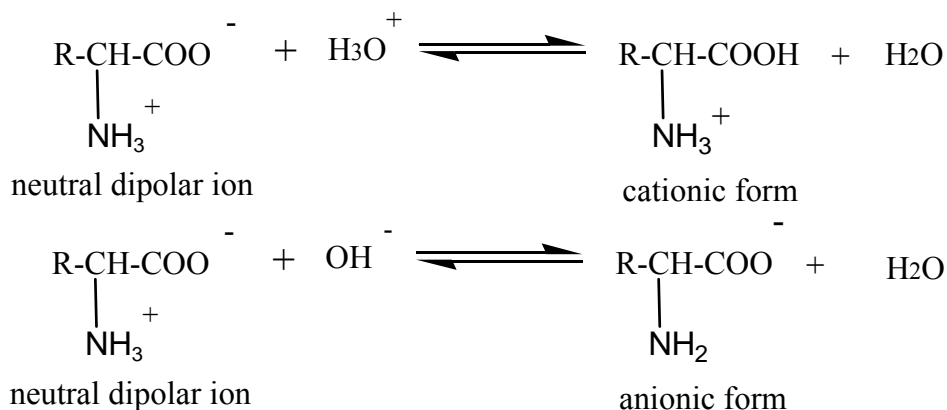

At some intermediate pH, the amino acid is present in an electrically neutral form. In such a case, called the isoelectric point (PI), the amino acid exists almost exclusively in the dipolar form. The isoelectric point depends on the structure of an amino acid. Neutral amino acids have isoelectric points in the pH range of 5.0–6.3. Due to amphoteric nature of amino acids they are able to neutralize

small quantities of acids or bases, thus maintaining a constant pH of the solution. Such compounds are termed **buffers** and are used in biochemical investigations. Demonstration of amino acid amphoteric nature is their ability to form colored soluble complex compounds with  $\text{Cu}^{2+}$ :

### Biologically important reactions

#### Deamination reactions

There are two types of the enzymic deamination (that is removal of an amino group) known for amino acids. The first one is the non-oxidative deamination that takes place without oxygen and leads to the  $\alpha,\beta$ -unsaturated carboxylic acids formation, for example:

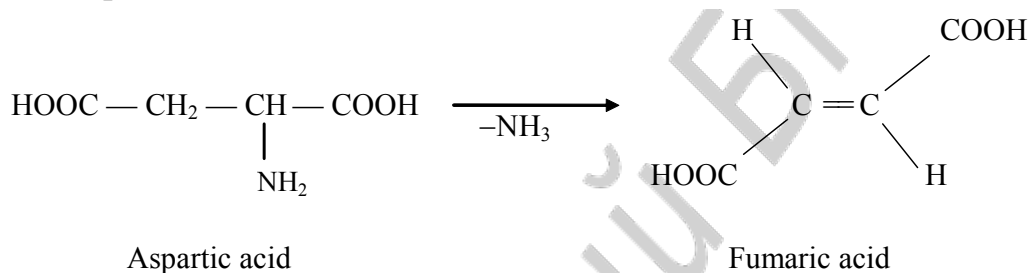

Another type of the reaction is the oxidative deamination which is a two step process. The first step represents the enzymic oxidation of an amino acid into an intermediate  $\alpha$ -imino acid in the presence of a coenzyme  $\text{NAD}^+$ . Subsequent hydrolysis leads to  $\alpha$ -oxo-acid formation:

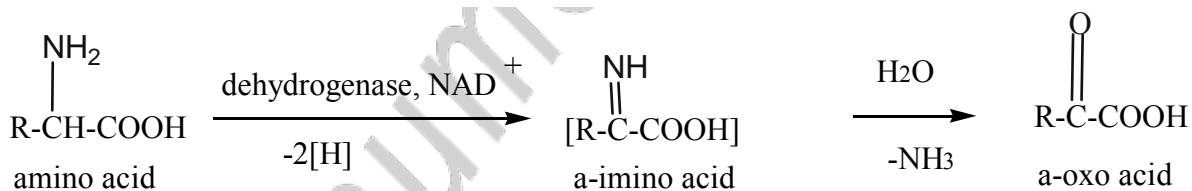

#### Transamination reactions

Transamination is the reaction between an [amino acid](#) and an alpha-keto acid. The amino group is transferred from the former to the latter; this results in the amino acid being converted to the corresponding  $\alpha$ -keto acid, while the [reactant](#)  $\alpha$ -keto acid is converted to the corresponding amino acid (if the amino group is removed from an amino acid, an  $\alpha$ -keto acid is left behind). Transamination in [biochemistry](#) is accomplished by enzymes called [transaminases](#) or aminotransferases. The human body synthesizes the 10 non-essential amino acids and transamination is the process by which most of these syntheses occur. The [chirality](#) of an amino acid is determined during transamination. This reaction uses the coenzyme pyridoxal-phosphate (vitamine  $\text{B}_6$ ). The product of transamination reactions depend on the availability of alpha-keto acids. The products usually are

either [alanine](#), [aspartate](#) or [glutamate](#), since their corresponding alpha-keto acids are produced through metabolism of fuels.

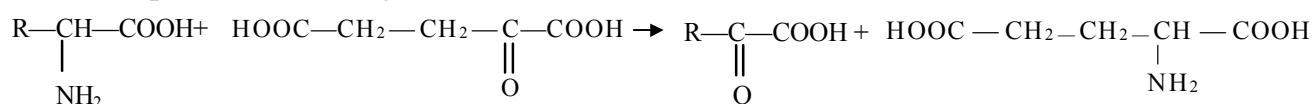

amino acid

$\alpha$ -ketoglutaric acid

keto acid

glutamic acid

### Decarboxylation reactions

This reaction also proceeds with the participation of pyridoxal phosphate and leads to the formation of naturally occurring amines. The simple diamines putrescine (1,4-butanediamine) and cadaverine occur (as their names suggest) in decomposing animal matter. Cadaverine is the decarboxylation product of lysine:

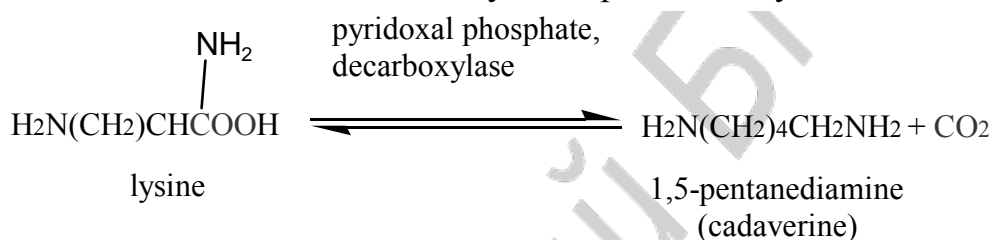

A similar reaction with histidine gives the biogenous amine, histamine.

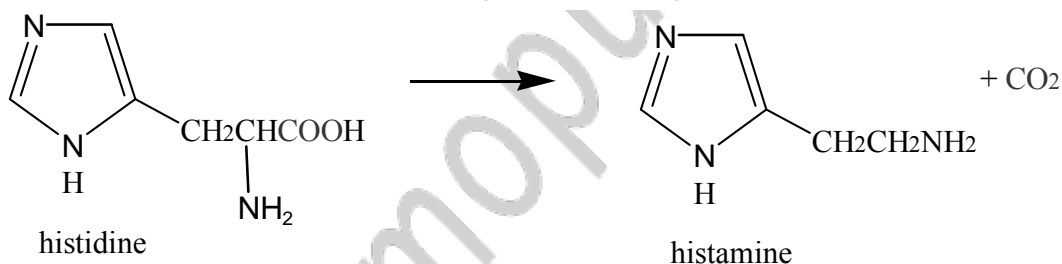

Dicarboxylic compound glutamic acid gives rise to 4-aminobutanoic acid (or  $\gamma$ -aminobutyric acid, abbreviated GABA), which is a natural neuroregulator:

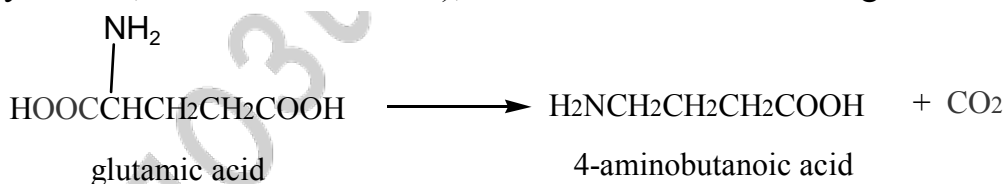

Tryptophan is decarboxylated in vivo to give tryptamine. Many compounds that contain the tryptamine skeleton have an effect on the brain and nervous system.

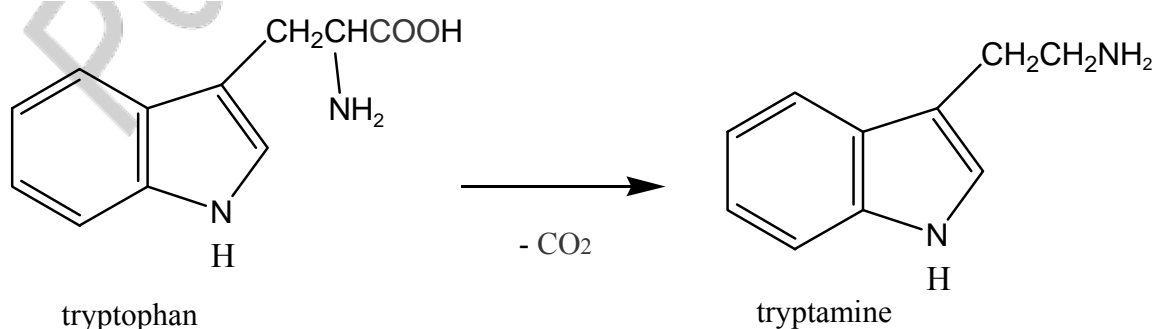

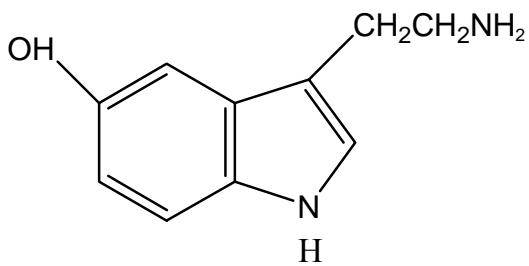

serotonine

For example, serotonin (5-hydroxytryptamine) is formed by hydroxylation of tryptamine. In the central nervous system, serotonin plays an important role as a neurotransmitter in the modulation of anger, aggression, body temperature, mood, sleep, sexuality, appetite, and metabolism, as well as stimulating vomiting.

Serotonin has broad activities in the brain, and genetic variation in serotonin receptors and the serotonin transporter, which facilitates reuptake of serotonin into presynapses, have been implicated in neurological diseases. Drugs targeting serotonin-induced pathways are being used in the treatment of many psychiatric disorders, and one focus of clinical research is the influence of genetics on serotonin action and metabolism in psychiatric settings. Levels of serotonin in the brain show association with aggression.

Репозитори

## Peptides, Their Structure, Properties. Value Levels of Protein Molecules Organization

Peptides are natural or artificial substances that consist of residuals of  $\alpha$ -amino

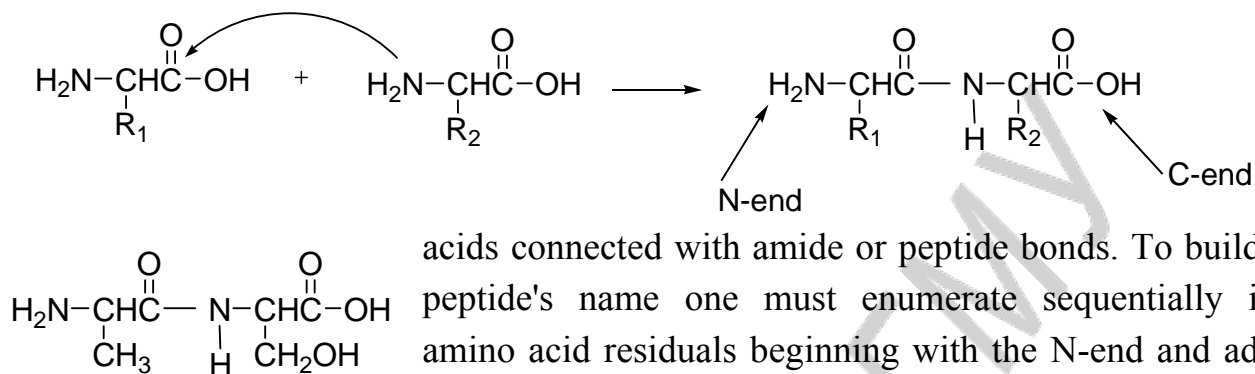

alanyl-serine

acids connected with amide or peptide bonds. To build a peptide's name one must enumerate sequentially its amino acid residuals beginning with the N-end and adding the suffix -yl. Only for the last (C-end) amino acid its full name is remained.

### The definition:

**The amino acid sequence, which means the rotation order of  $\alpha$ -amino acid residuals, is named the primary structure of peptides or proteins.**

It is determined by a nucleotide sequence in DNA encoding this protein, and i-RNA. The primary structure also determines the higher levels of organization which are formed spontaneously.

Unlike proteins, peptides have a more heterogeneous composition. In particular they often include D-amino acids.

**Glutathione** is *tripeptide*,  $\gamma$ -glutamylcysteinylglycine. All animal and vegetable cells, bacteria contain it. The presence of cysteine means that glutathione can exist both in a reduced and in an oxidated form. Glutathione takes part some oxidation-reduction processes. It performs the function of protein protector (a substance that prevents proteins with free SH-groups from oxidation and forming disulfide bonds - S-S-). It concerns the proteins for which this process is unwanted. Glutathione in such cases is oxidized itself and so protects such proteins.

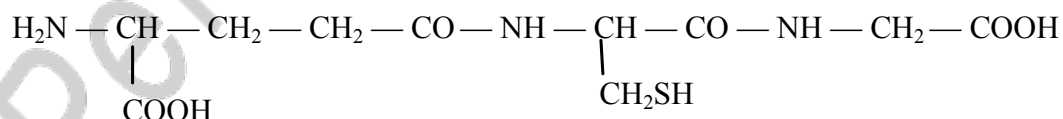

**Aspartame** consists of residuals of L-aspartic acid and the methyl ester of L-phenylalanine. It is used as a sugar substitute (sweetener). It's almost 200 times sweeter than sucrose.

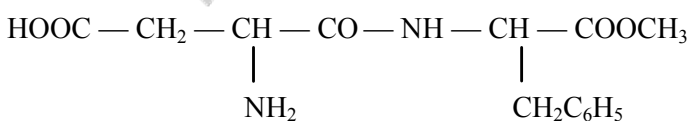

**Neuropeptides** (opiate peptides) are peptides which the brain contains. The first neuropeptides named enkephalines were extracted from an animal brain in 1975. They both are pentapeptides differing only with their C-end amino acids:

- methionine-enkephaline;
- leucine-enkephaline.

These peptides render analgetic action and are used as drugs.

**Insulin** is a hormone responsible for the control of the metabolism of carbohydrates, fats and proteins. It's produced by the beta-cells of the pancreas. Serious disturbances of carbohydrate metabolism such as diabetes are connected with insulin deficiency so insulin is used for their treatment. Insulin consists of 2 peptide chains (A and B) connected with 2-disulfide bonds. A-chain has 21 amino acid residuals; B-chain has 30 ones.

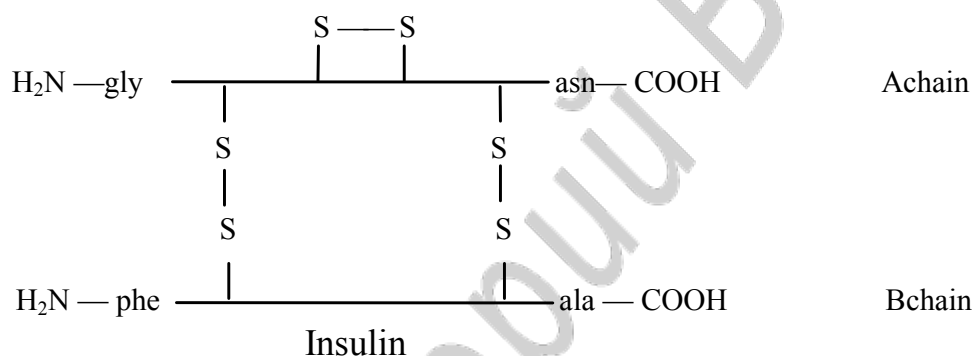

### Artificial synthesis of peptides

The classical peptide synthesis is performed in a solution. The strategy of peptide synthesis is already developed. It includes blocking some functional groups and activating others at proper stages. The groups that generate amide bonds (the carboxyl group of one amino acid and the amino group of the other) must be active).

Solid-phase peptide synthesis after Merrifield is carried out on a solid polymeric carrier. The first amino acid attaches to it with its carboxyl group. Then the polypeptide chain is being augmented. The peptide is cleansed from impurities on the carrier and then is removed from it.

### Electronic and spacial structure of the peptide bond

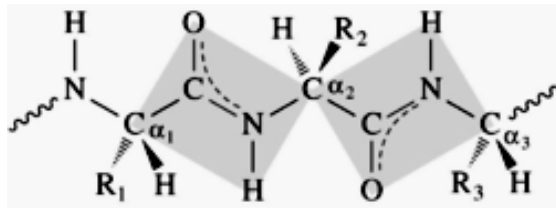
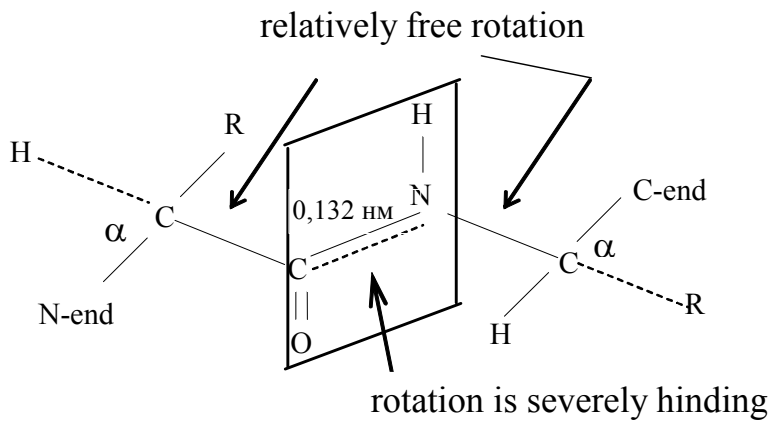

The peptide bond has a flat structure: carbon, oxygen and nitrogen atoms are in the sp<sup>2</sup>-hybridization. N-atom has a p-orbital with an unshared pair of electrons. A p-π-conjugated system is formed; it leads to shortening of the C-N bond (0,132 nm). A flat conjugated system complicates the rotation about the C-N bond. That's why the electronic structure predetermines a rather strict flat structure of peptide group. α-Carbon atoms

are situated on the opposite sides of the C-N bond. A polypeptide chain may be presented as a number of angularly located planes of peptide groups connected with alpha-carbonic atoms using C-N and α-C-Csp<sup>2</sup> bonds. The rotation about these bonds is restricted because of the difficulties with the spatial placement of side radicals. Thus the electronic and spatial structure makes a great contribution to the determination of the structure of a polypeptide chain.

## The secondary and tertiary structure of peptides

### The definition:

**Secondary structure is a local conformation of a definite part of a polypeptide chain which appears as a result of rotation about σ-bonds of α-carbon atoms of a polypeptide chain and leading to a high order and stabilization.**

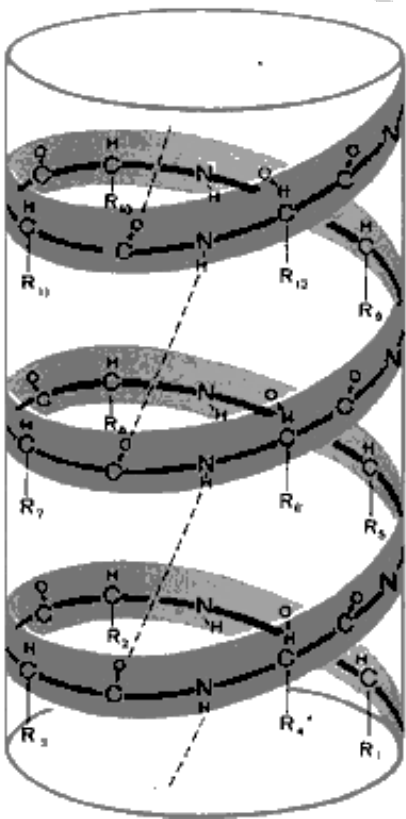

The most examined secondary structures are an α-helix, a β-structure and β-turn.

An α-helix is a right handed helical structure, because residuals of L-α-amino acids take part in its forming. 3.6 Amino acids residuals correspond to each turn of the spiral. The height of one turn is 0.54 nm. An α-helix is stabilized with hydrogen bonds between NH- and CO-

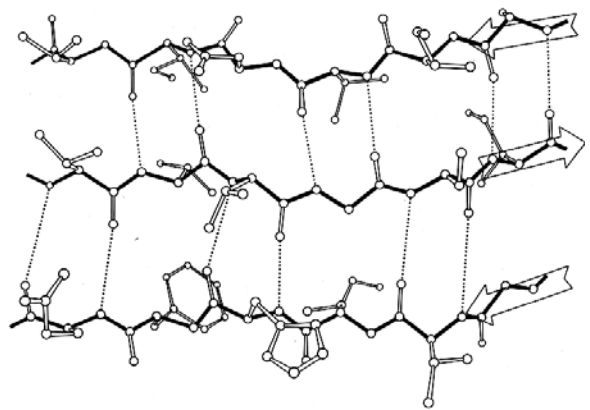



groups of the main chain. A CO-group of each amino acid is connected using a hydrogen bond with a NH-group of an AA located 4 residuals ahead in a linear sequence.

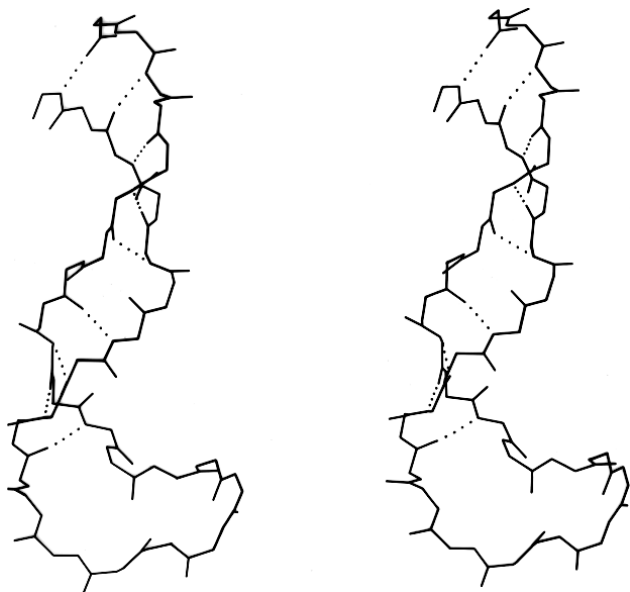

$\beta$ -Structure is formed from rather elongated polypeptide chains. There are 2 types of  $\beta$ -structure:

- a parallel  $\beta$ -folded layer if the direction of the polypeptide chains is identical;
- antiparallel if the polypeptide chains are directed inversely.

This type of conformation is stabilized with hydrogen bonds between NH- and CO-groups of different polypeptide chains in fibrillar proteins or different

parts of the same polypeptide chain in globular proteins.

A  $\beta$ -turn is being formed at a part of a polypeptide chain where it turns  $180^\circ$  to acquire a compact spherical form. This turn is formed when a CO-group of a residual  $n$  in a polypeptide chain is joined to a NH- group of an  $n+3$  residual of an amino acid by a hydrogen bond.  $\beta$ -Turn usually includes 4 amino acid residuals (the most common ones are residuals of proline and glycine) and is stabilized with interchain hydrogen bonds.

**The definition:**

**A polypeptide chain including some elements of one or another secondary structure is able to be located in the space in a certain way forming a tertiary structure.**

Side radicals of amino acid residuals which are considerably remote in a polypeptide chain but brought together at the expense of bends of the chain interact. Tertiary structure is stabilized with different types of bonds and interactions.

A covalent disulfide bond is formed between cysteine residuals of the same protein chain or different ones. The energy of such bond is about 293 kJ/mole.

Hydrogen bonds, ionic and hydrophobic interactions are of great importance for forming a tertiary structure. These bonds are very weak but due to a great number of individual weak interactions define the spatial structure and stability of a protein molecule.

As a rule hydrogen bonds are formed between a mobile atom of hydrogen carrying a partial positive charge (acid site), for example, -OH, -NH, -SH, and a pair of electrons of a heteroatom (base site), usually O or N. A hydrogen bond has a donor-acceptor nature.

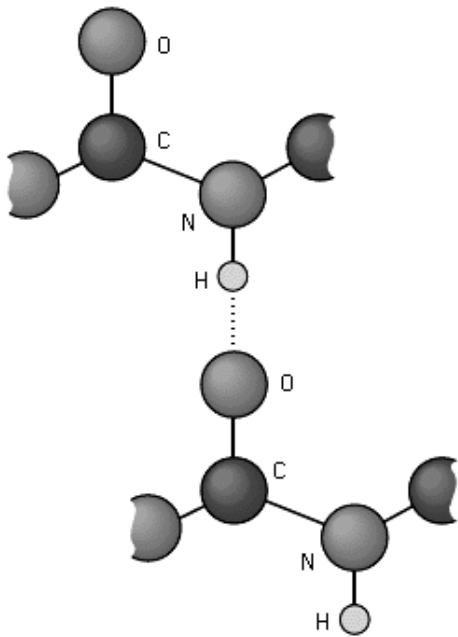

The most important for forming and stabilizing of the spatial structure of proteins are hydrogen bonds between CO- and NH-groups of a spiral or folded polypeptide chain. Among possible hydrogen bonds one can name the bonds in which functional groups of side radicals, for example the OH-group of serine, threonine or tyrosine, the SH-group of cysteine, the NH<sub>2</sub>-group of aspartic or glutamic acid participate.

A hydrophobic interaction has an entropic nature. Hydrophobic substitutes are pushed out of the water and tend inside the protein molecule restricting their contact with water. Hydrophobic clusters are formed. They have the minimum of energy. The energy of such interaction is about 6.5 kilojoules/mole.

Ionic (electrostatic) interaction is an interaction between ionized radicals and polar radicals of amino acid residuals with the opposite charge. The energy of such interactions in hydrophobic surroundings can rise to 35–40 kJ/mole. However the amount of such interactions in a protein molecule is not large.

The way of the spatial structure organization usual for proteins is forming a hydrophobic nucleus and a mosaic surface which has and a mosaic surface which has both hydrophilic and hydrophobic elements. It limits the size of the globule. Beginning with the molecular weight of 14–16 kDa there is a tendency to forming a protein molecule from 2 or more globules. Each globule has its own hydrophobic nucleus. Such globules — domains — are formed by different segments of the same polypeptide chain.

Thus domains are some areas in the tertiary structure of a protein which have certain autonomy of their structural organization.

Quaternary structure is a way of location in the space of separate polypeptide chains (identical or different) with tertiary structure that leads to forming of an integrated (structurally and functionally) macromolecular formation.



Each polypeptide chain in a multidomain protein's structure is named a protomer. Protomers are complementary and are bound to an integrated supramolecular structure by noncovalent bonds. A single protomer usually has no biological activity. Hemoglobin is an example of a protein with quaternary structure. Its main function as the principal component of erythrocytes is the transport of oxygen from lungs to tissues. Its quaternary structure is a formation of 4 polypeptide chains (subunits); each of them contains heme. Heme is located in a hollow that each subunit has. This hollow is named "heme pocket". Oxygen is bound by a molecule cooperatively, that means binding of one O<sub>2</sub> molecule makes the future bindings easier. A hemoglobin molecule is able to get "information" from the environment and so change its sensitivity to oxygen. Protons, CO<sub>2</sub> joining hemoglobin at places remote from the heme, weaken hemoglobin's ability to bind oxygen. Proteins, the sensitivity of which to substratum is regulated by addition of different effectors at other places of a protein molecule are named allosteric protein. So proteins are not rigid structures but conformational mobile ones. Conformational mobility may affect either separate  $\sigma$ -bonds or domains.

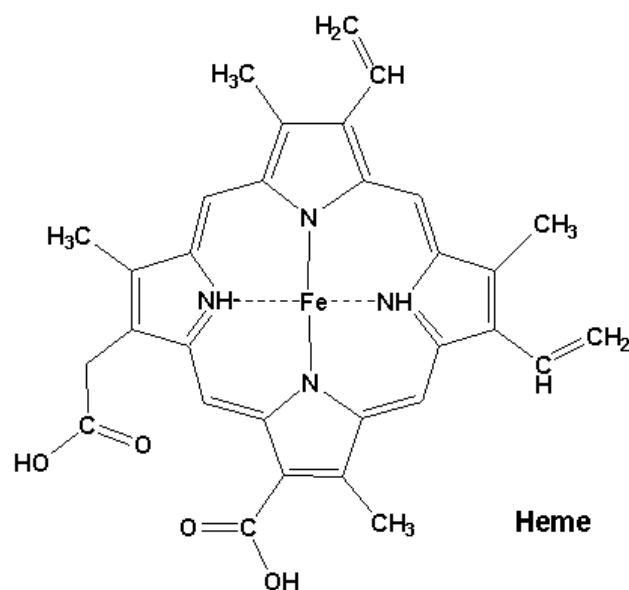

Spatial structure of proteins can be broken under the influence of different factors: rise of the temperature, pH changes, ultraviolet light or X-ray emission, mechanical effect (for example, mixing of solutions), chemical agents (urea, mercaptoethanol sodium dodecyl sulfate, salts). Breaking of the native macrostructure of proteins is named **denaturation**. As a rule, noncovalent interactions which stabilize protein's structure are broken. Denaturation makes protein solubility worse, and they are no more biologically active. Denaturation may be reversible or irreversible. If it's reversible, an active (renaturated) protein may be got after removing denaturants.

## Nucleic Acids

The nucleic acids, deoxyribonucleic acid (DNA) and ribonucleic acid (RNA), are, respectively, the molecules that preserve hereditary information and that transcribe and translate it in a way that allows the synthesis of all the varied proteins of the cell. These biological polymers are sometimes found associated with proteins and in this form they are known as **nucleoproteins**.

We shall focus our attention on the structures and properties of the nucleic acid components, **nucleotides** and **nucleosides**. Nucleotide consists of the heterocyclic base, the sugar (D-ribose or 2-deoxy-D-ribose) and phosphate. Removal of the phosphate group of a nucleotide converts it to a compound known as a nucleoside. The nucleosides that can be obtained from DNA all contain 2-deoxy-D-ribose as their sugar component and one of four heterocyclic bases, either adenine, guanine, cytosine, or thymine. The nucleosides that can be obtained from RNA all contain D-ribose as their sugar component and one of four heterocyclic bases, either adenine, guanine, cytosine, or uracil.

The aromatic compounds, purine and pyrimidine, lie on the base of the heterocyclic base structures.

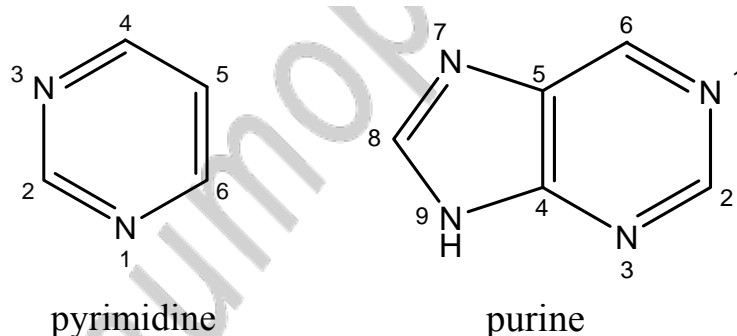

### Pyrimidines

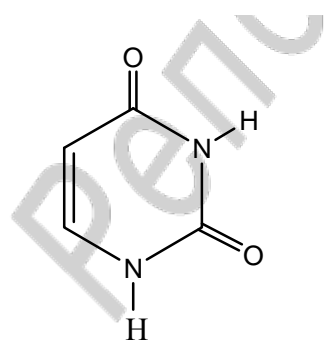

Uracil

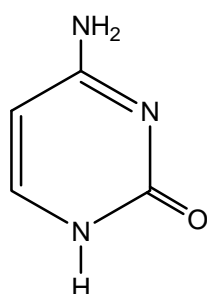

Cytosine

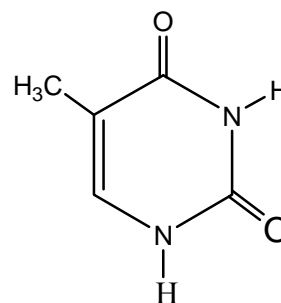

Thymine

## Purines

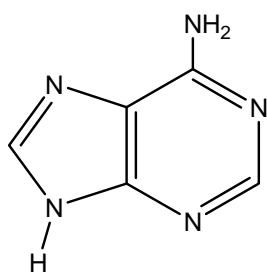

Adenine

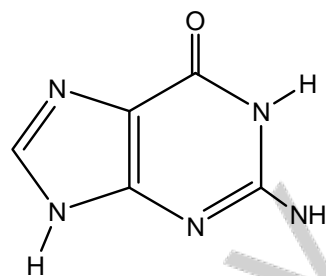

Guanine

The heterocyclic bases are capable of existing in more than one tautomeric form. Lactam forms are the predominant forms that the bases assume when they are present in nucleic acid.

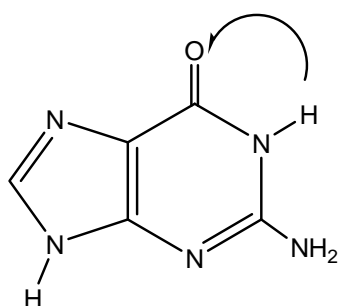

Guanine  
lactam form

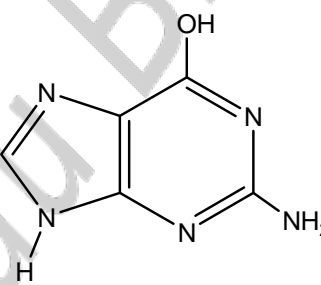
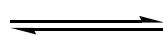

lactim form



Uracil  
lactam form

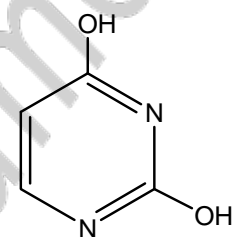
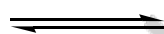

lactim form

Nucleosides are the building blocks of nucleic acids. Nucleosides are N-glycosides that constructed from two components: a sugar and a heterocyclic base. D-ribose and 2-deoxy-D-ribose are in the cyclic  $\beta$ -furanose form.

The names and the structures of the nucleosides are shown below.

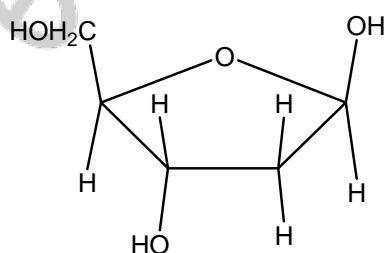

$\beta$ ,D-deoxyribofuranose

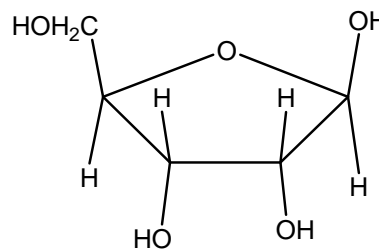

$\beta$ ,D-ribofuranose

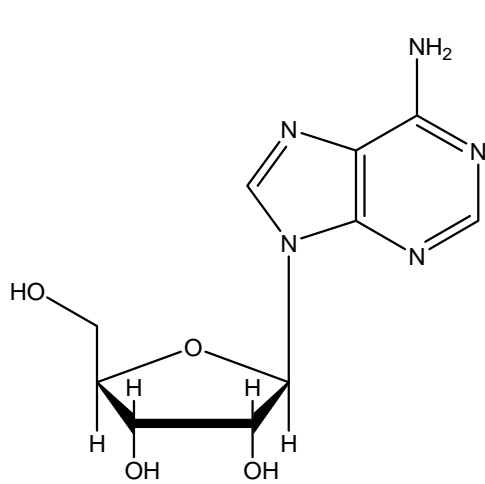

Adenosine

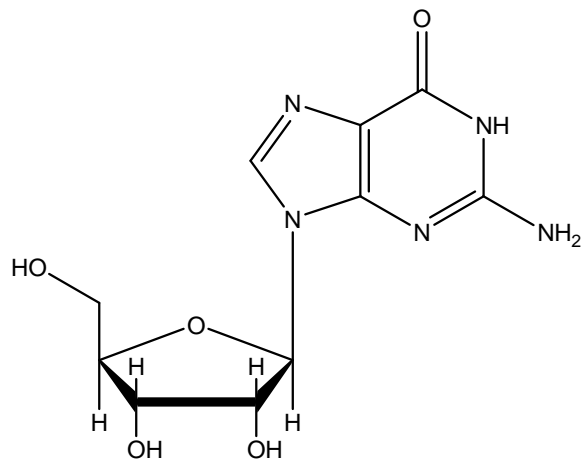

Guanosine

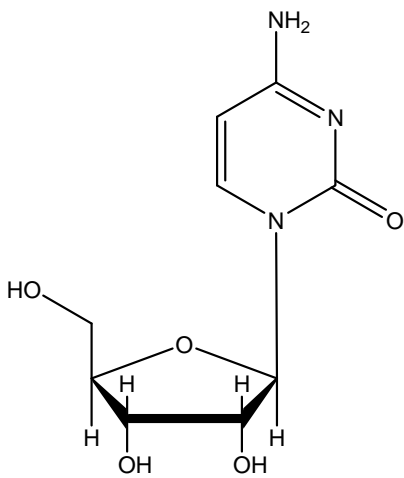

Cytidine

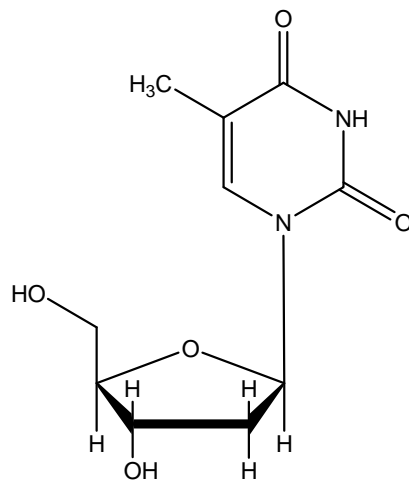

2-deoxythymidine

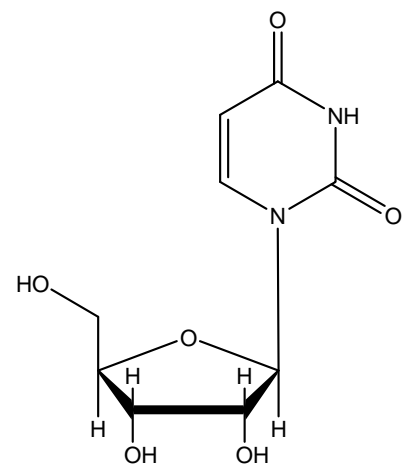

Uridine

The nucleosides which are constituents of RNA	The nucleosides which are constituents of DNA
adenosine guanosine cytidine uridine	2-deoxyadenosine 2-deoxyguanosine 2-deoxycytidine 2-deoxythymidine

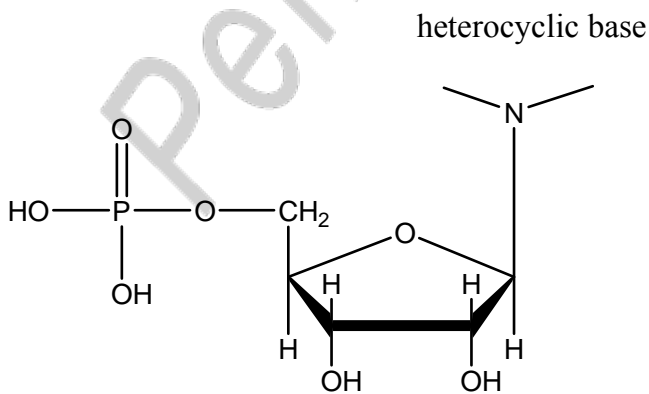

In a nucleotide, the phosphate group replaces the hydroxy group at C5 of the D-ribose or 2-deoxy-D-ribose portion of the nucleosides (5' position). The heterocyclic base and the ribose fragments are numbered separately and to differentiate between them a " ' " (called "prime") is added to the ribose

numbers. Phosphate esterification usually occurs at the 5' position of the D-ribose, although it does occur at the 2' and 3' positions.

A general formula for a nucleotide is shown in the following figure (esterification at the 5' position).

Nucleotides possess acid properties, because they contain phosphate. And under physiological conditions nucleotides exist at the ionized form.

Complete hydrolysis of a nucleotide gives (PH=1):

- 1) a heterocyclic base, either a purine or pyrimidine;
- 2) a five-carbon monosaccharide, either D-ribose or 2-deoxy-D-ribose;
- 3) a phosphate ion.

Under PH=4 or PH=9 hydrolysis of a nucleotide gives:

- 1) a nucleoside;
- 2) a phosphate ion.

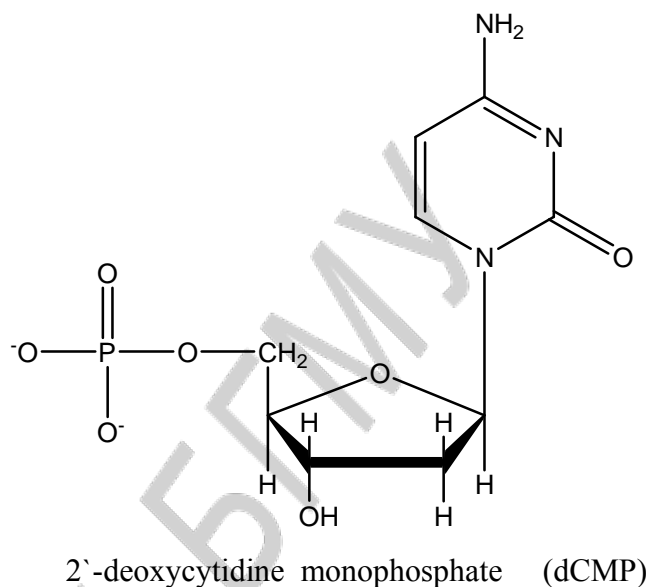

## Nucleic acids

Nucleotides are the components of DNA and RNA. DNA is found in the cell nucleus. RNA molecules are generally much smaller and are found outside the nucleus of the cell. In 1953 James Watson and Francis Crick suggested a double helix structure for DNA. The structure of DNA contains 2 long antiparallel chains of deoxyribose nucleotides connected with a phosphate ester. The phosphate ester of one deoxyribose connects C3' to C5' on the next deoxyribose. The various bases connect to C1' of the deoxyribose. The end of polymeric chain that has a free hydroxyl group at C5' is called the **5' end** and the end with a free OH at C3' is called the **3' end**. Each end can be phosphorylated.

**The primary structure of the nucleic acid is a sequence in which nucleotides are bound in a chain.**

The polymerisation reaction in DNA and RNA occurs by the 3'-hydroxyl group on the end of an existing primer strand forming a phosphodiester with a 5' phosphate on a nucleotide, displacing a pyrophosphate leaving group.

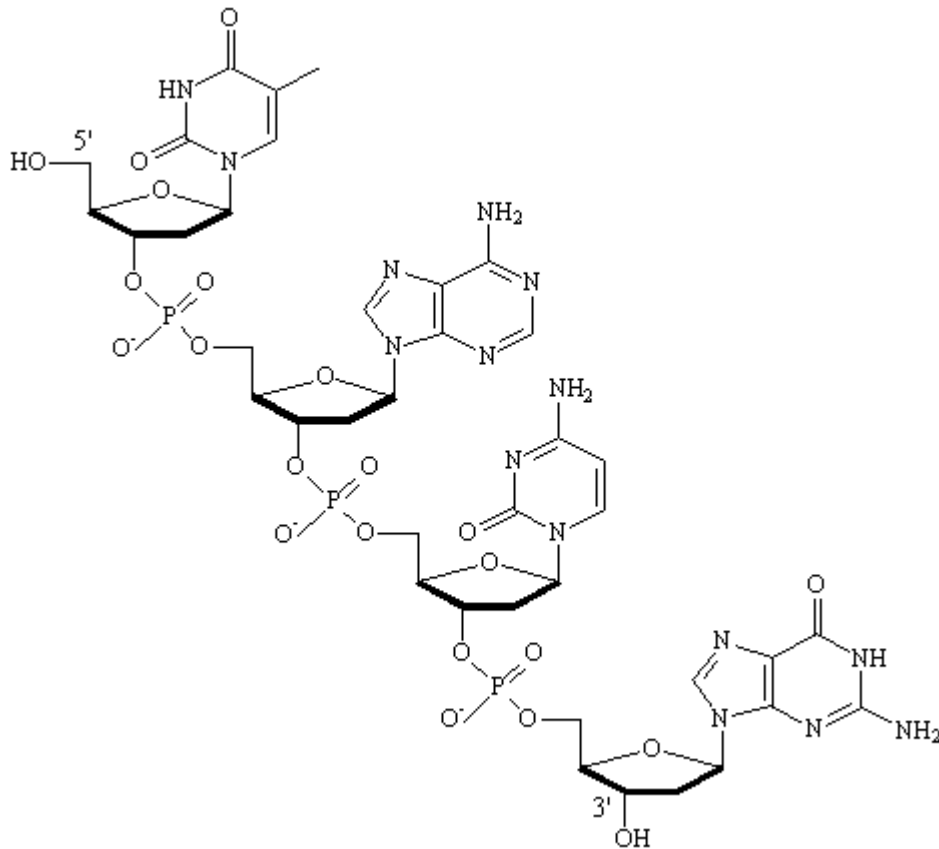

**The secondary structure of the nucleic acid is a dimensional organization of a macromolecule.**

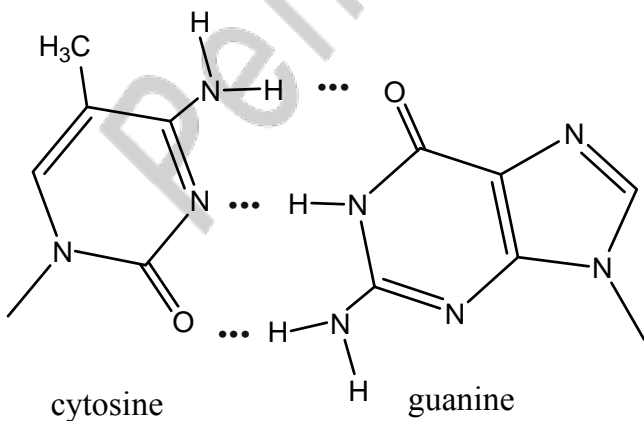
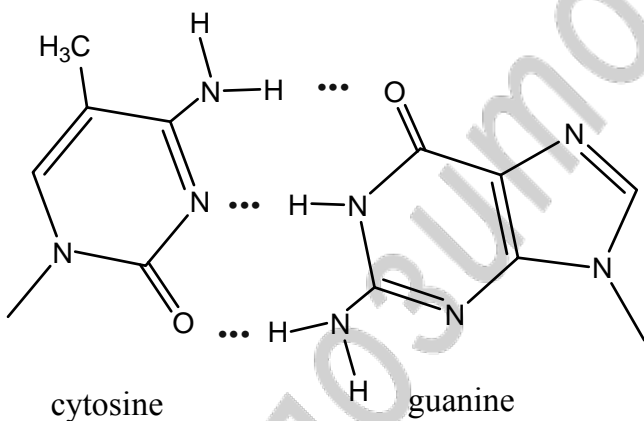

Two factors are mainly responsible for the stability of the DNA double helix: base pairing between complementary heterocyclic bases by hydrogen bonds and **stacking** between adjacent bases. Watson and Crick show that two chains of base-deoxyribose nucleosides join together with hydrogen bonds between bases in adjacent chains. These hydrogen bonds join two pairs: adenine-thymine, guanine-cytosine.

Base stacking refers to the interaction between nearest-neighbour nucleotides along the same strand. This is a very complex interaction that depends on Van der Waals forces, electrostatic dipole forces between bases, and solvation effects, i. e. whether the DNA base



is better bound to water, rather than to the adjacent base. “Aromatic stacking” refers both to the geometry of face-to-face of two aromatic molecules so that the  $\pi$ -systems are in direct contact.

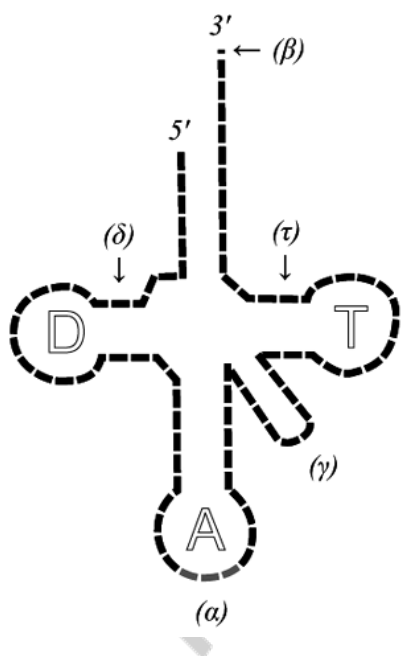
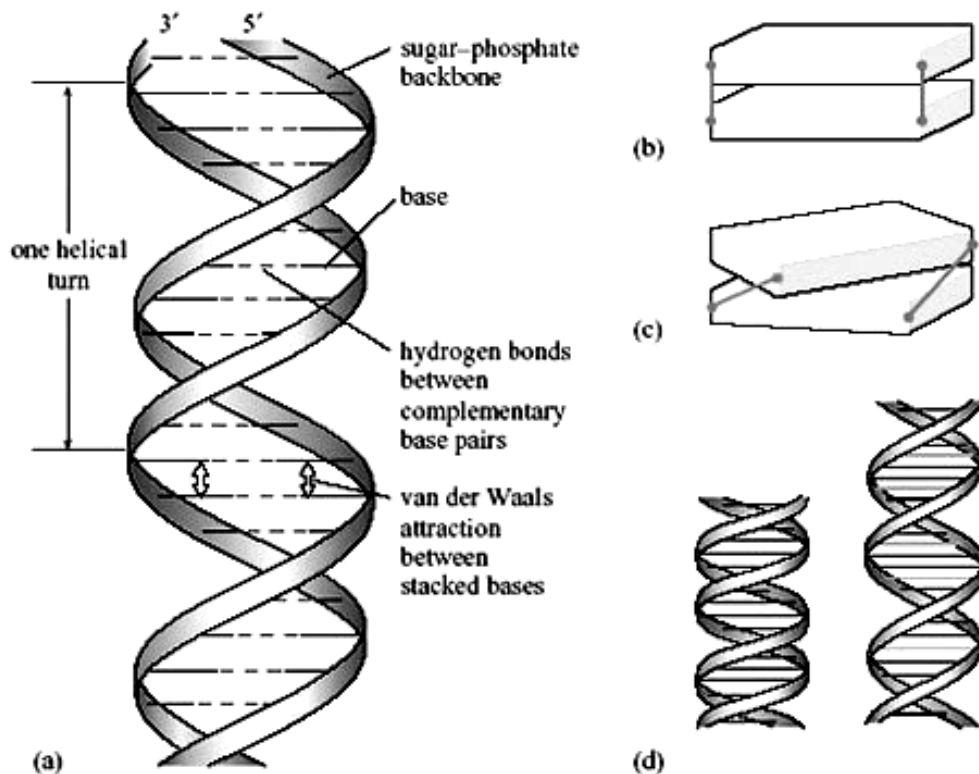

RNA is structurally similar to DNA. Like DNA, RNA has a sugar-phosphate polymer backbone with heterocyclic bases attached. But the sugar in RNA is ribose, not deoxyribose. Uracil substitutes for thymine. RNA molecules are smaller than DNA. The most RNA molecules exist as single strands. There are 4 types of RNA: ribosomal RNA (rRNA), messenger RNA (mRNA), transport RNA (tRNA) and small interfering RNA (si-RNA). Messenger RNA is the RNA that carries information from DNA to the [ribosome](#), the sites of protein synthesis ([translation](#)) in the cell. The coding sequence of the mRNA determines the [amino acid](#) sequence in the [protein](#) that is produced. Many RNAs

do not code for protein however. The most prominent examples of non-coding RNAs are tRNA and rRNA, both of which are involved in the process of translation. tRNA is

a small [RNA](#) (usually about 74–95 nucleotides) that transfers a specific [amino acid](#)

to a growing polypeptide chain at the ribosomal site of protein synthesis during [translation](#). It has a [3' terminal](#) site for amino acid attachment. This covalent linkage is catalyzed by an [aminoacyl tRNA synthetase](#). It also contains a three [base](#) region called the [anticodon](#) that can base pair to the corresponding three base [codon](#) region on [mRNA](#). Each type of tRNA molecule can be attached to only one type of amino acid, but because the [genetic code](#) contains multiple codons that specify the same amino acid, tRNA molecules bearing different anticodons may also carry the same amino acid.

rRNA is the central component of the [ribosome](#), the protein manufacturing machinery of all living [cells](#). The function of the rRNA is to provide a mechanism for decoding [mRNA](#) into [amino acids](#) and to interact with the [tRNAs](#) during [translation](#) by providing [peptidyl transferase](#) activity.

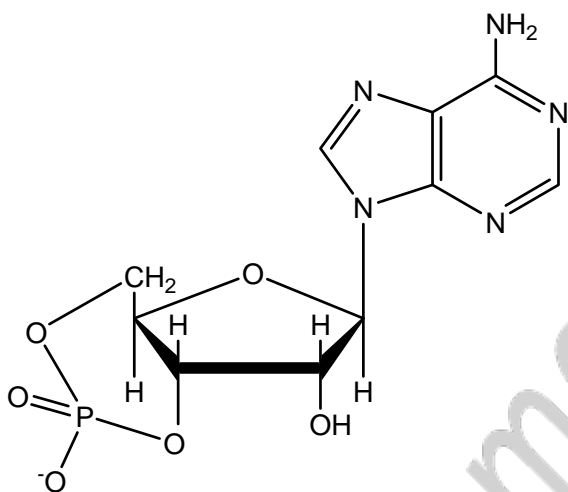

Nucleotides and nucleosides are found in places **other** than as part of the structure of DNA and RNA. The compound called 3',5'-cyclic adenilic acid (cyclic AMP) is an important regulator of hormone activities.

The 5'-triphosphate of adenosine is the energy source, ATP. This molecule contains 2 unhydride bonds. When unhydride bond is hydrolyzed, a large energy amount is released.

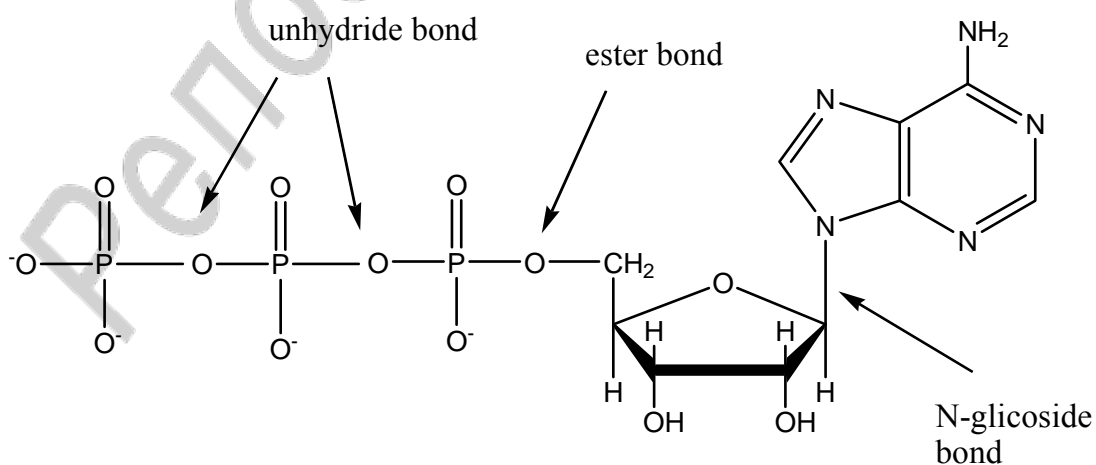
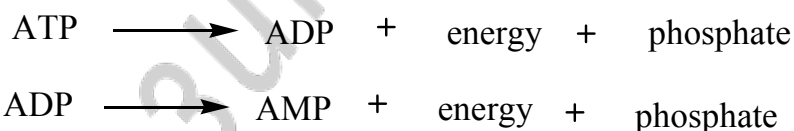

ATP participates in the phosphorylation (esterification by phosphoric acid) reactions. For example, the first step of glycolysis is a reaction of the glucose phos-

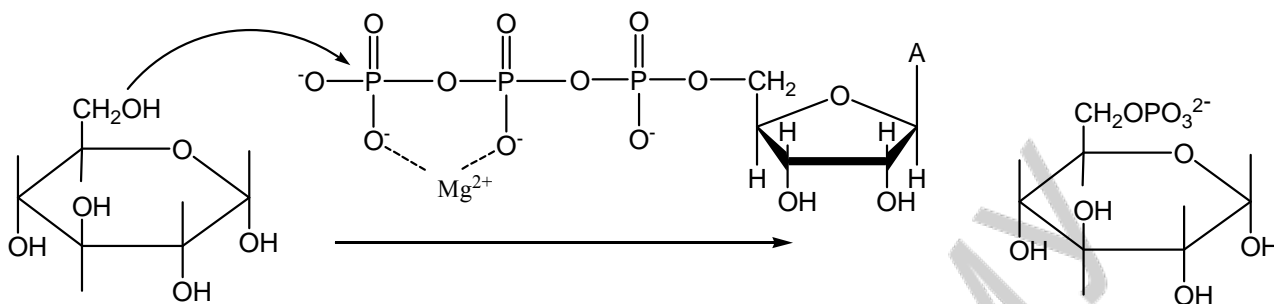

phorylation. The phosphate ester forms via a nucleophilic substitution reaction involving the C6 hydroxyl group of glucose. The reaction requires the presence of a magnesium ion to help the nucleophilic attack.

We have seen, that adenosine unit is part of the structure of coenzyme  $\text{NAD}^+$ . Coenzyme  $\text{NAD}^+$  participates in oxidation-reduction reactions. The role of  $\text{NAD}^+$  consists in abstraction of a hydride ion from a substrate by the pyridinium ion of the nicotinamide part. As a result nicotinamide loses aromaticity. It is formed  $\text{NADH}$ , nicotinamide adenine dinucleotide reduced.

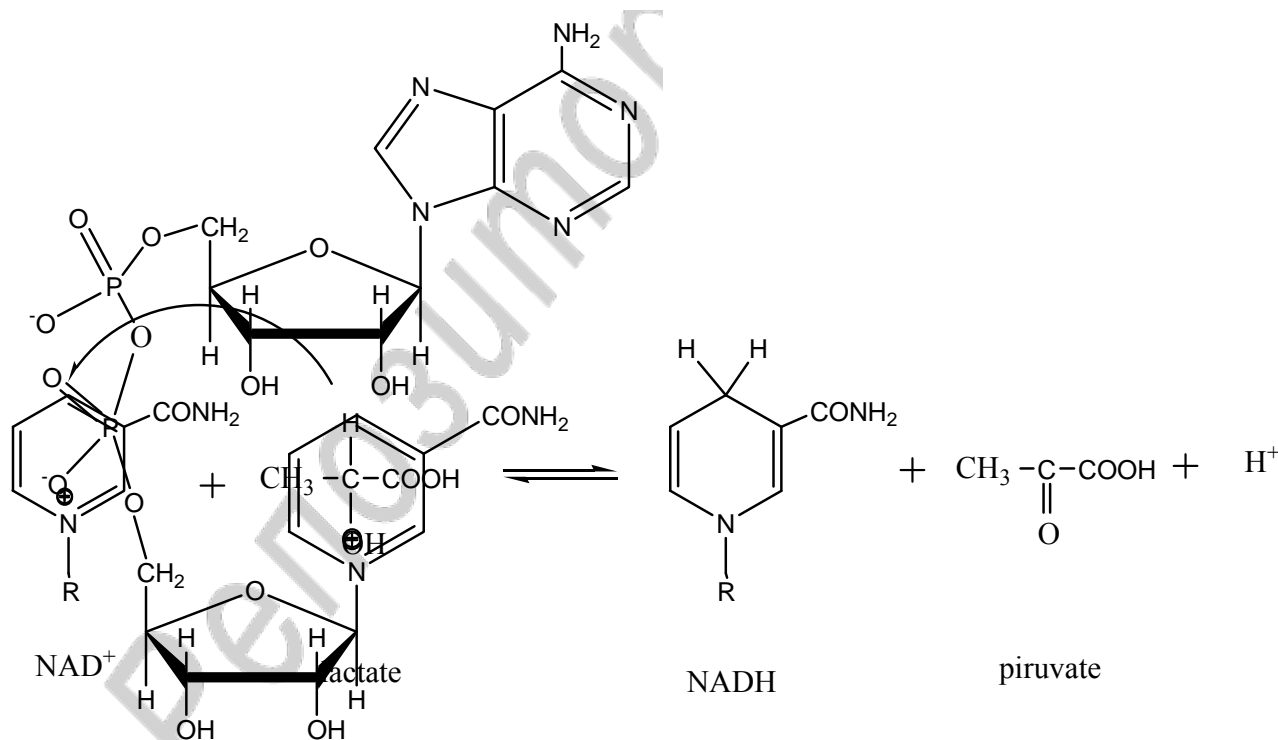

Nicotineamide adenine dinucleotide

## Steroids

Steroids are important biological regulators that nearly always show dramatic physiological effects. Among these important compounds there are male and female sex hormones, adrenocortical hormones, D vitamins, the bile acids and others. Steroids are derivatives of the following perhydrocyclopentanophenanthrene system. The carbon atoms of this ring system are numbered as shown below.

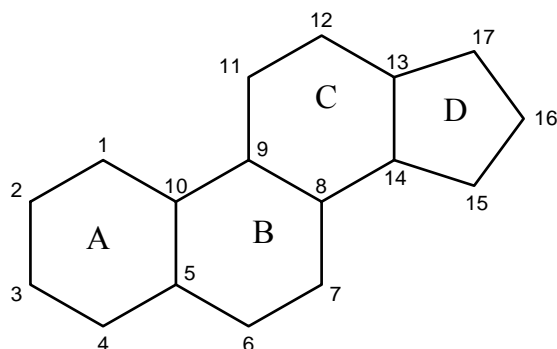

The four **rings** are designated with letters.

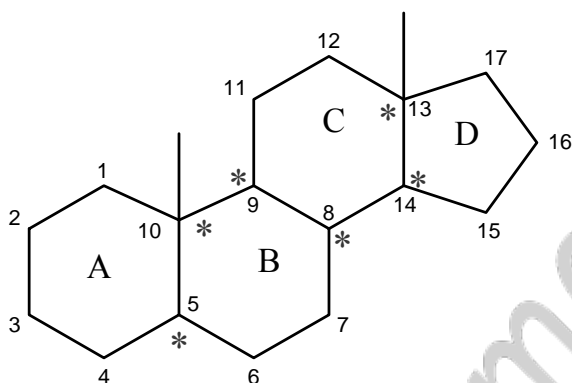

Perhydrocyclopentanophenanthrene system has 6 chiral sites. In most steroids the B, C and C, D ring junctions are trans. The A, B ring junction however, may be either cis or trans and this possibility gives rise to two general groups of steroids having the three-dimensional structures shown in the following figures.

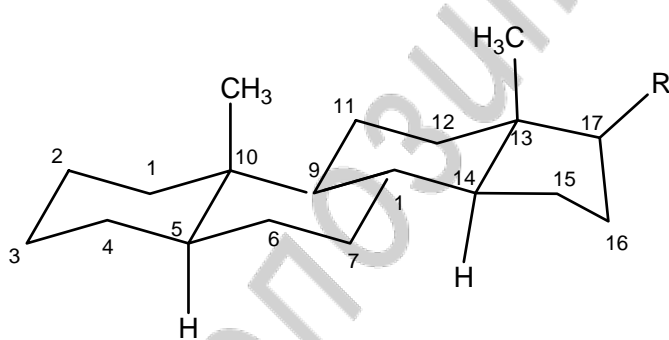

5 $\alpha$ -steroid (all ring junctions are trans)

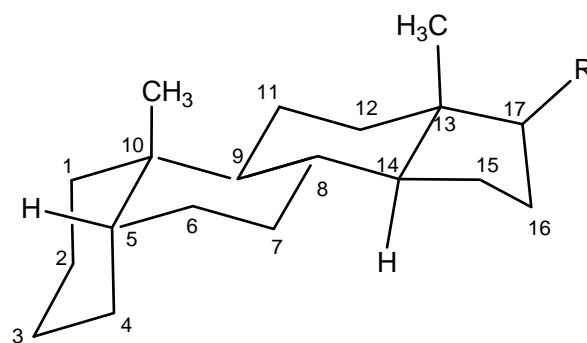

5 $\beta$ -steroid (A,B ring junction is cis)

The methyl groups attached at points of ring junction (i. e., those numbered 18 and 19) are called **angular methyl groups**. The angular methyl groups protrude above the general plane of the ring system when it is written in the manner shown in figures above. By convention, other groups that lie on the same side the molecule as the angular methyl groups (i. e., on the top side) are designated as  $\beta$  substituents. Groups that lie generally on the bottom (i. e., are trans to the angular methyl groups)

are designated as  $\alpha$  substituents. When  $\alpha$  and  $\beta$  designations are applied to the hydrogen atom at position 5, the ring system in which the A, B ring junction is trans becomes the  $5\alpha$  series; and the ring system in which the A, B ring junction is cis becomes the  $5\beta$  series.

In the systematic nomenclature the nature of the R group at position 17 determines the base name of an individual steroid. These names are derived from the steroid hydrocarbon names given in the following table.

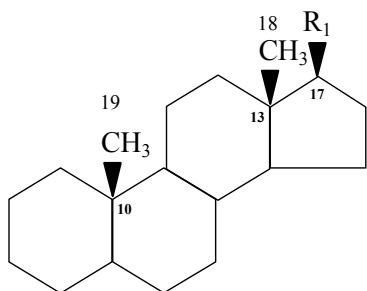

Steroid base names

Name	C members	R <sub>3</sub>
Estrane	18	H (C <sub>19</sub> is absent)
Androstane	19	H
Pregnane	21	—CH <sub>2</sub> —CH <sub>3</sub>
Cholane	24	
Cholestane	27	

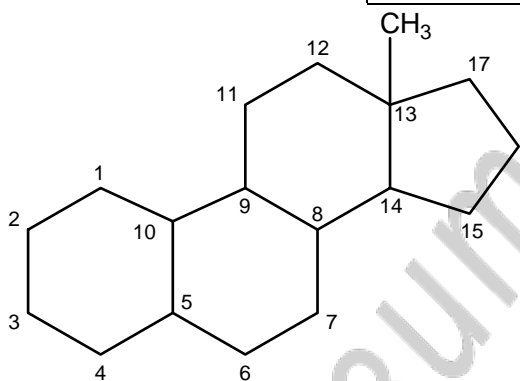

Estrane

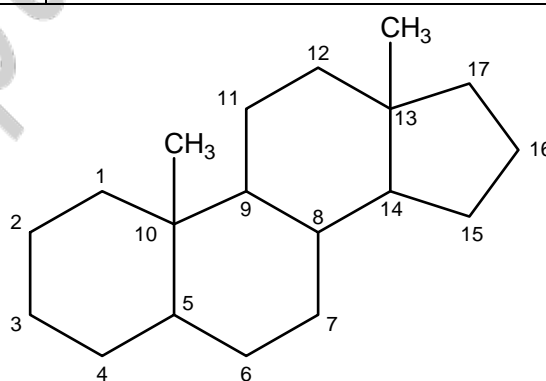

Androstane

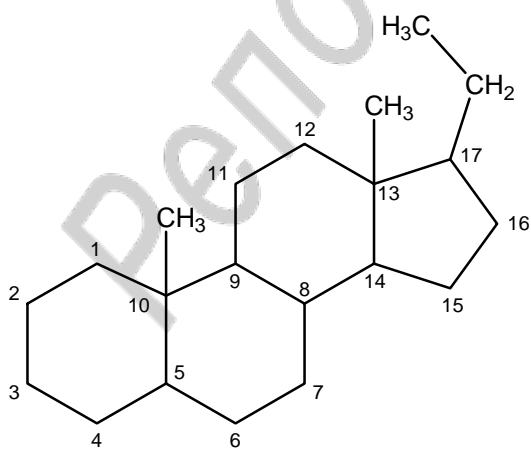

Pregnane

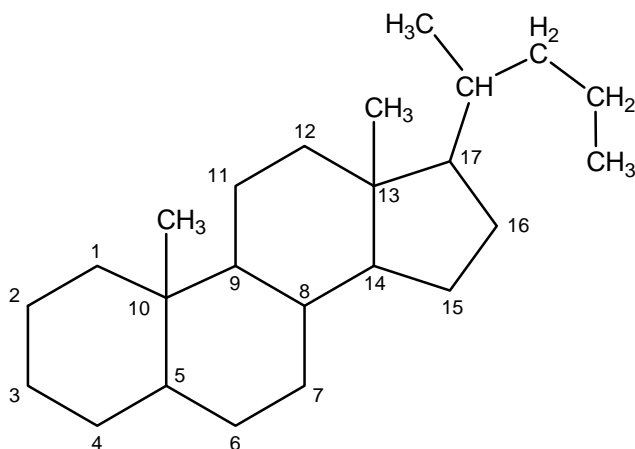

Cholane

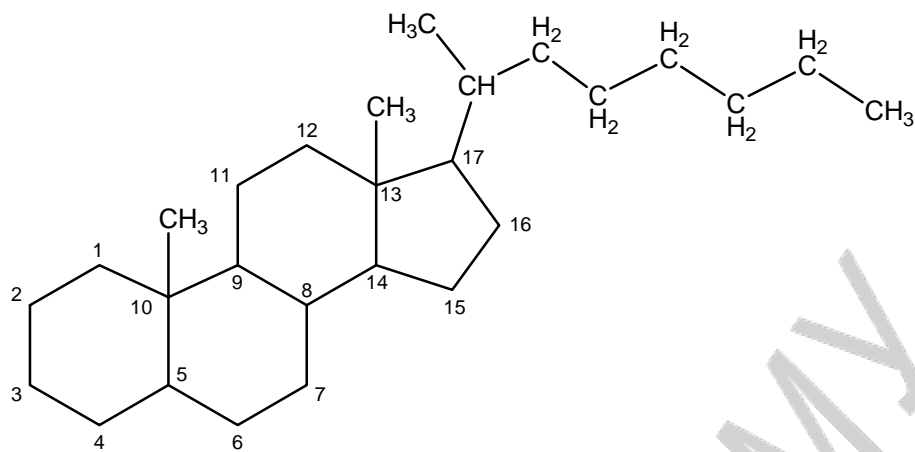

Cholestane

The steroid hormones are all derived from cholesterol. All the steroid hormones exert their action by passing through the plasma membrane and binding to intracellular receptors. The steroid hormone receptors belong to the steroid and thyroid hormone receptor super-family of proteins. They include receptors for steroid hormones, thyroid hormones, vitamin D and vitamin A (retinoic acid). Both the steroid and thyroid hormone-receptor complexes bind specific nucleotide sequences in the DNA of responsive genes. These DNA sequences are identified as hormone response elements. The interaction of steroid-receptor complexes with DNA leads to altered rates of transcription of the associated genes.

The sex hormones can be classified into three major groups: the female sex hormones, or estrogens, the male sex hormones, or androgens, and the pregnancy hormones, or progestins.

The first isolated sex hormone was estrogen or estrone. Later, a much more potent estrogen, called estradiol, was isolated. Estradiol is a true female sex hormone, and estrone is a metabolized form of excreted estradiol.

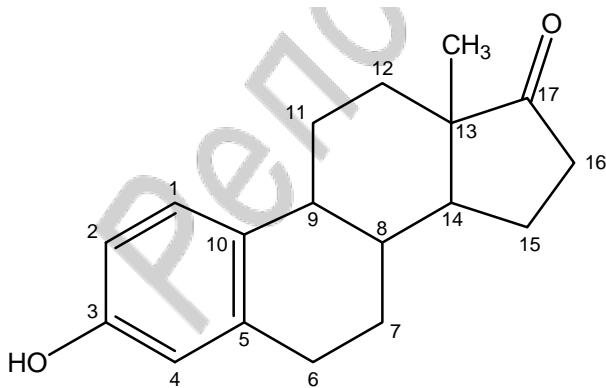

Estrone

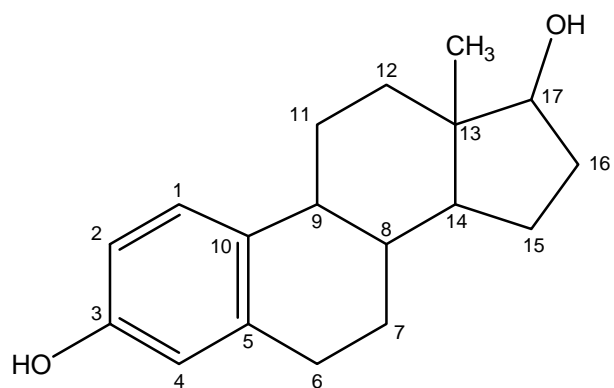

Estradiol

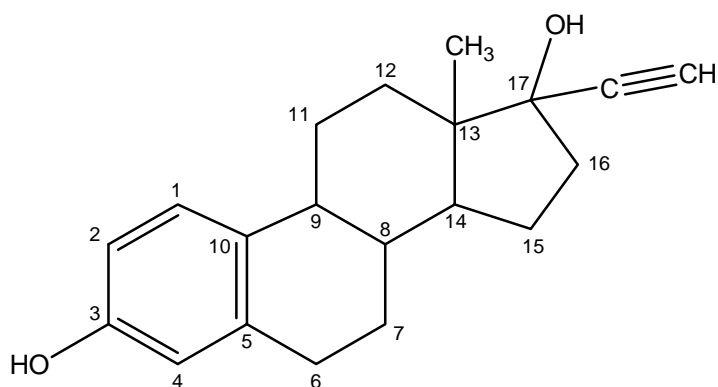

Ethynylestradiol

Estradiol is secreted by the ovaries and promotes the development of the secondary female characteristics. Estrogens also stimulate the development of the mammary glands during pregnancy.

Synthetic estrogens have also been developed and these are often used in oral contraceptives in combination with synthetic progestins.

A very potent synthetic estrogen is the compound called ethynylestradiol.

In 1931 the first androgen or androsterone was isolated. Soon afterwards (in 1935), Ernest Laqueur isolated another male sex hormone, testosterone. It soon became clear that testosterone is the true male sex hormone and androsterone is a metabolized form of testosterone is excreted in the urine.

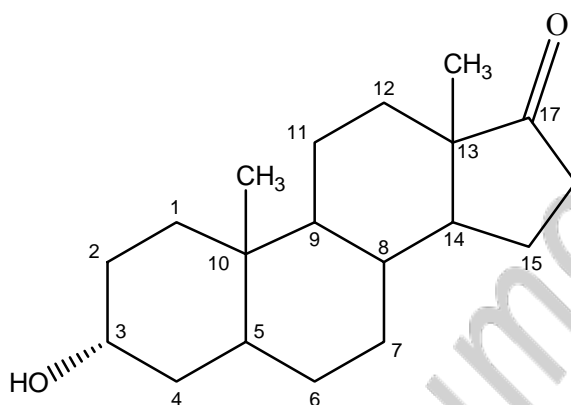

Androsterone

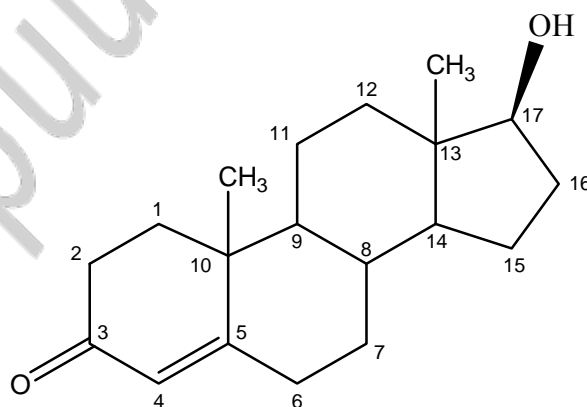

Testosterone

Testosterone, secreted by the testes, is the hormone that promotes the development of secondary male characteristics: the growth of facial and body hair; the deepening of the voice; muscular development; and the maturation of the male sex organs.

Testosterone and estradiol, then, are the chemical compounds from which "maleness" and "femaleness" are derived. It is especially interesting to examine their structural formulas and to see they differ only a slight degree. Testosterone has an angular methyl group at the A,B ring junction missing in estradiol. Ring A of estradiol is a benzene ring and, as a result, estradiol is phenol. Ring A of testosterone contains an  $\alpha,\beta$ -unsaturated keto group.

Progesterone is the most important progestin (pregnancy hormone). After ovulation occurs, the corpus luteum begins to secrete progesterone. This hormone pre-

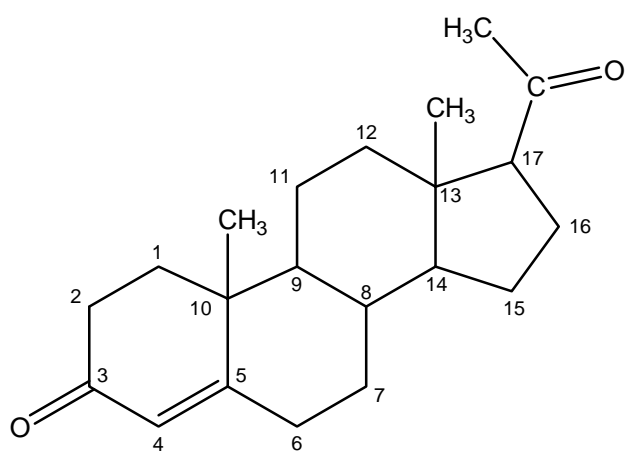

Progesterone

prepares the lining of the uterus for implantation of the fertilized ovum, and continued progesterone secretion is necessary for the completion of pregnancy.

At least 28 different hormones have been isolated from the adrenal cortex. Included in this group are the following two steroids:

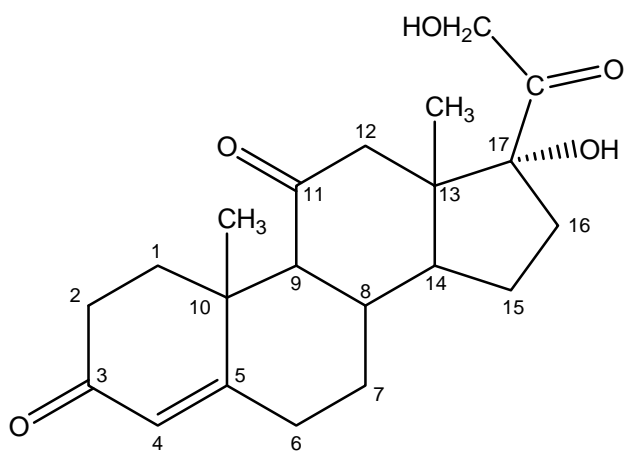

Cortisone

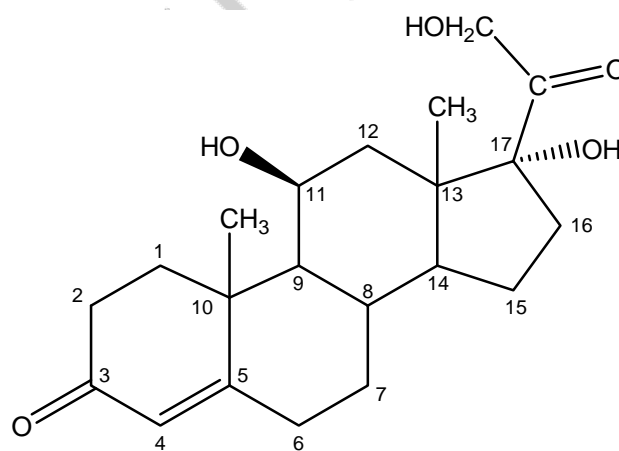

Cortisol

Most of the adrenocortical steroids have an oxygen function at position 11 (a keto group in cortisone, for example, a  $\beta$ -hydroxyl in cortisol). Cortisol is the major hormone synthesized by the human adrenal cortex.

The adrenocortical steroids are apparently involved in the regulation of a large number of biological activities including carbohydrate, protein, and lipid metabolism,

water and electrolyte balance, and reactions to allergic and inflammatory phenomena. Most of 11-oxygenated steroids are now used in the treatment of a variety of disorders ranging from Addison's disease, to asthma, and to skin inflammations.

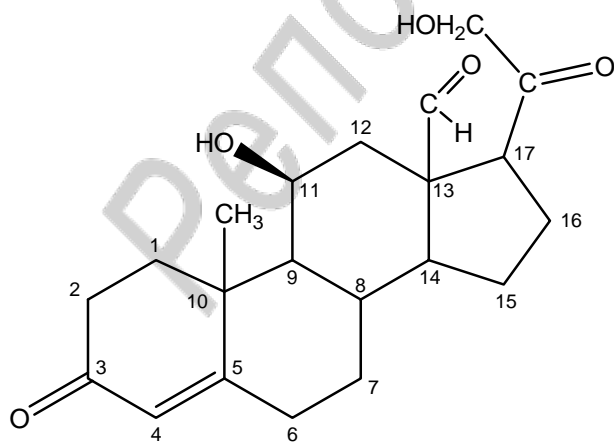

Aldosterone

The most important mineralocorticoid is aldosterone, which regulates the reabsorption of sodium and chloride ions in the kidney tubules and increases the loss of potassium ions. Aldosterone is



secreted when blood sodium ion levels are too low to cause the kidney to retain sodium ions. If sodium levels are elevated, aldosterone is not secreted, so that some sodium will be lost in the urine. Aldosterone also controls swelling in the tissues.

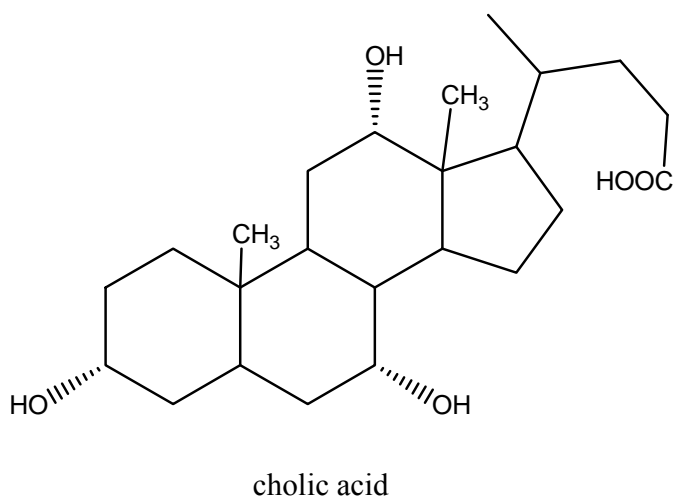

tives represent approximately eighty percent of all bile acids. Both these bile acids, in addition to the others, can be conjugated to taurine or glycine. Conjugation, a function carried out by the liver will result in a lowered pKa and therefore, the compounds will remain ionized. These ionized compounds will stay in the gastrointestinal tract until reaching the ileum where they will be reabsorbed.

The purpose of this conjugation is to keep the bile acids in the tract until the end to facilitate lipid digestion all the way to the ileum.

Bile is produced by the liver and stored in the gallbladder. When secreted into the small intestine, bile emulsifies lipids by acting as soap. This action aids in the digestive process.

Cholesterol, one of the most widely occurring steroids, can be isolated by extraction of nearly all animal tissues. Human gallstones are a particularly rich source. Cholesterol contains eight tetrahedral stereocenters. This feature means that  $2^8$  or 256 possible stereoisomeric forms of the basic structure are possible, only one of which is cholesterol.

Cholic acid and chenodeoxycholic acid are the most important human bile acids. Some other mammals synthesize predominantly deoxycholic acid. Salts of cholic acid are called cholates. Cholic acid, along with chenodeoxycholic acid, is one of two major bile acids produced by the liver where it is synthesized from cholesterol. Of the two major bile acids, cholate deriva-

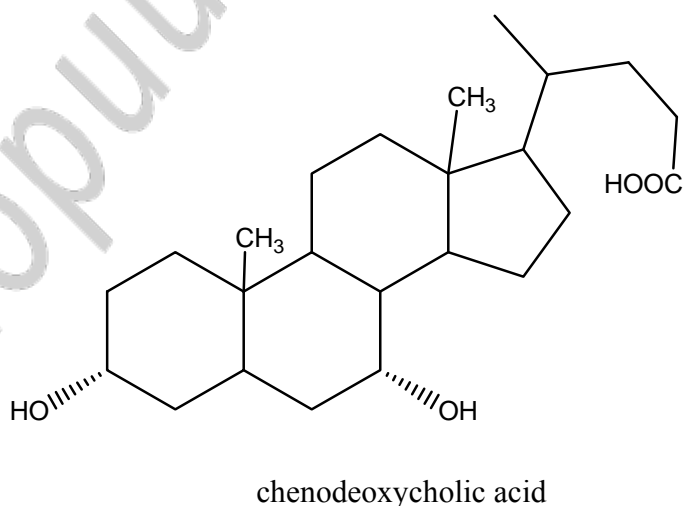

Cholesterol is widely spread in the human body, but not all of the biological functions of cholesterol are yet known. Cholesterol is known to serve as an intermediate in the biosynthesis of all of the steroids of the body. Cholesterol, therefore, is essential to life. We do not need to have cholesterol in our diet, however, because our body itself can synthesize. When we ingest cholesterol, our body synthesizes less than if we ate none at all, but the total cholesterol is more than if we ate none at all.

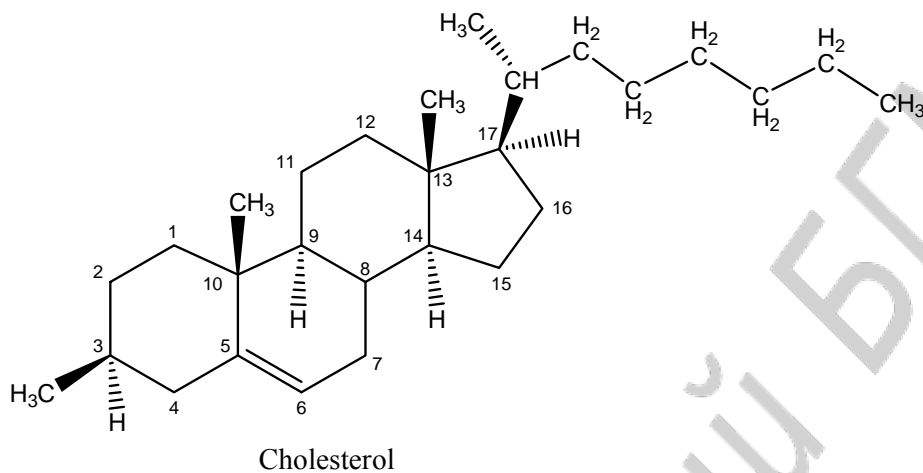

Far more cholesterol is present in the body than is necessary for steroid biosynthesis. High levels of blood cholesterol have been implicated in the development of arteriosclerosis (hardening of the arteries).

In 1932, the structure of highly active substance vitamin D<sub>2</sub> was demonstrated. The photochemical reaction that takes place is one in which the dienoid ring B of ergosterol opens to produce a conjugate triene:

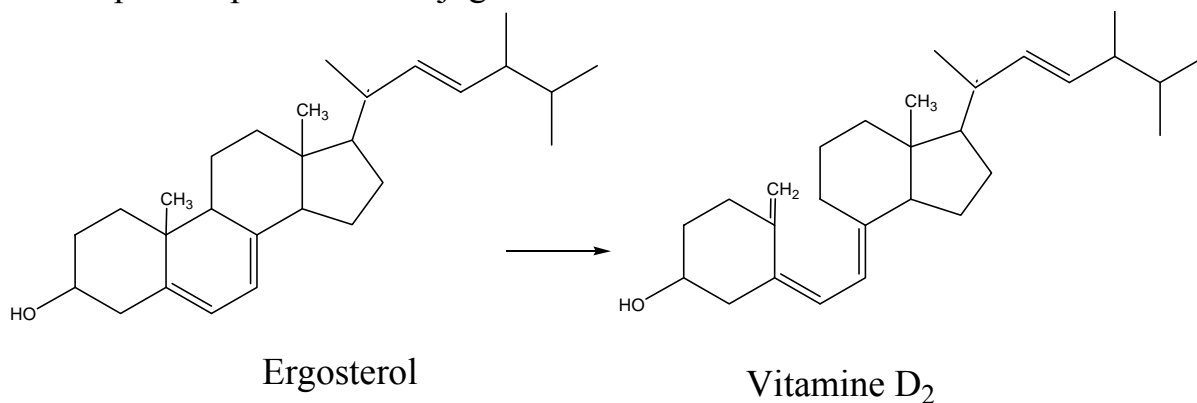

In human body cholesterol is the source of vitamin D<sub>3</sub>. First it is formed cholecalciferol, which is hydroxylized in liver and kidney (C<sub>25</sub> and C<sub>1</sub>).



## Contents

Spatial structure of the organic molecules .....	3
Conjugation. Aromaticity of carbo- and heterocyclic compounds .....	14
Acidity and basicity of organic compounds .....	21
Mechanisms of organic reactions .....	27
Nucleophilic substitution reactions: S <sub>N2</sub> and S <sub>N1</sub> mechanisms. Elimination reactions .....	40
Carbonyl compounds .....	45
Nucleophilic substitution reactions in carboxylic acids. Fatty acids, structure, nomenclature, properties .....	65
Poly- and heterofunctional compounds .....	74
Lipids, classification, properties. Phospholipids as structural components of biological membranes .....	90
Monosaccharides. Structure, tautomeric forms, reactivity, biological role .....	98
Chemical properties of monosaccharides .....	104
Monosaccharides derivatives .....	107
Polysaccharidies: structure, biological role .....	109
Structure and reactivity of amino acids acting as a heterofunctional compounds .....	118
Peptides, their structure, properties. Value levels of protein molecules organization .....	127
Nucleic acids .....	133
Steroids .....	141
Literature .....	148

Учебное издание

**Ринейская** Ольга Николаевна  
**Прокопчик** Кристина Григорьевна

**БИООРГАНИЧЕСКАЯ ХИМИЯ  
ТЕОРЕТИЧЕСКИЙ КУРС**

**BIOORGANIC CHEMISTRY  
THEORETICAL COURSE**

Учебно-методическое пособие

На английском языке

Ответственная за выпуск О. Н. Ринейская  
В авторской редакции  
Компьютерная верстка Н. М. Федорцовой

Подписано в печать 26.06.08. Формат 60×84/8. Бумага писчая «КюмЛюкс».

Печать офсетная. Гарнитура «Times».

Усл. печ. л. 17,67. Уч.-изд. л. 8,4. Тираж 43 экз. Заказ 493.

Издатель и полиграфическое исполнение –

Белорусский государственный медицинский университет.

ЛИ № 02330/0133420 от 14.10.2004; ЛП № 02330/0131503 от 27.08.2004.

220030, г. Минск, Ленинградская, 6.