

МИНИСТЕРСТВО ЗДРАВООХРАНЕНИЯ РЕСПУБЛИКИ БЕЛАРУСЬ
БЕЛОРУССКИЙ ГОСУДАРСТВЕННЫЙ МЕДИЦИНСКИЙ УНИВЕРСИТЕТ
КАФЕДРА БИОЛОГИИ

**МЕДИЦИНСКАЯ БИОЛОГИЯ
И ОБЩАЯ ГЕНЕТИКА**

**ДЛЯ ИНОСТРАННЫХ СТУДЕНТОВ
1-го ГОДА ОБУЧЕНИЯ**

**MEDICAL BIOLOGY AND GENETICS
FOR INTERNATIONAL STUDENTS 1ST YEAR**

Учебно-методическое пособие

5-е издание, исправленное



Минск БГМУ 2014

УДК 575.1(811.111)-054.6 (075.8)
ББК 28.704 (81.2 Англ-923)
М42

Рекомендовано Научно-методическим советом университета в качестве
учебно-методического пособия 16.04.2014 г., протокол № 8

А в т о р ы: доц. В. Э. Бутвиловский; доц. В. В. Давыдов; проф. И. В. Рачковская;
доц. Н. И. Мезен; доц. Л. М. Сычик; ассист. Е. А. Черноус

Р е ц е н з е н т ы: д-р мед. наук, проф. Б. А. Слука; д-р мед. наук, проф. Э. А. До-
ценко

Медицинская биология и общая генетика для иностранных студентов 1-го
М42 года обучения = Medical biology and genetics for international students 1st year :
учеб.-метод. пособие / В. Э. Бутвиловский [и др.]. – 5-е изд., испр. – Минск :
БГМУ, 2014. – 220 с.

ISBN 978-985-567-025-5.

Издание содержит теоретический материал 32 тем практических занятий по медицинской био-
логии и общей генетике, термины, открытые и закрытые тесты. В данном издании уточнены отве-
ты на тесты, устранены ошибки. Первое издание вышло в 2008 г.

Предназначено для иностранных студентов 1-го курса, обучающихся на английском языке.

УДК 575.1(811.111)-054.6 (075.8)
ББК 28.704 (81.2 Англ-923)

ISBN 978-985-567-025-5

© УО «Белорусский государственный
медицинский университет», 2014

HUMAN IN THE SYSTEM OF NATURE

Origin of life. Evidence of the organic world evolution. Life is a way of existence of protein bodies that are constantly exchanging energy, substance and information with the environment. The complex of proteins and nuclear acids is a biochemical substrate of life (its material basis).

Hypotheses of life origin:

- **creationism** — life was created by God;
- **self-generation** — life originated many times from non-living matter;
- **stationary condition** — life existed always;
- **panspermia** — life was brought to the Earth from other planets;
- **biochemical** — life came into existence due to biochemical evolution.

The evidences of the organic life evolution are: paleontologic (transient forms, philogenetic series); comparative-anatomic (identical structural plan of chordal animals; homologous organs, rudiments and atavisms); embryologic (the law of embryonal similarity, biogenetic law); molecular-genetic data.

1. Organization levels of living things. Properties and characters of living things.

Properties of living things:

- **self-regulation** — the ability to modify one's own vital activity according to environmental changes;
- **self-renewal** — the ability to synthesize, restore or replace its own structural-functional components;
- **self-generation** — the ability to reproduce identical oneselves, increasing the number of the species and providing the continuity of generations.

These properties define *characters of living things*:

- **exchange of substances and energy**;
- **heredity** — provides transmission of characters from generation to generation during reproduction;
- **variation** — causes the appearance of new characters in environmental changes;
- **reproduction** (multiplication);
- **ontogenesis** (individual development) and **phylogenesis** (historical development of species);
- **growth** — enlargement in size, volume and mass of organisms;
- **irritability** — response of organisms to environmental factors;
- **homeostasis** — the ability to sustain the constancy of internal environment and structural organization;
- **integrity and discretion** (division into components).

Organization levels of living matter:

1. **Molecular-genetic** — *gene* is an elementary unit at this level.

2. **Cellular** — all living organisms consist of cells. The cell is a structural-functional and genetic unit of living things. It contains genetic information about the development of the whole organism. All vital processes take place there.

3. **Tissue** — a group of cells with identical structure performing identical functions form the *tissue*.

4. **Organism**. The organism is an elementary unit of life. The *organism* level is characterized by processes of ontogenesis (individual development), its nervous and humoral regulation.

5. **Population-specious**. A group of individuals of one species, occupying a definite territory for a long time, freely crossing and relatively isolated from other groups of individuals of the same species, form a *population*. The population is an elementary unit of evolution.

6. **Biospheric-biogeocenotic**. *Biogeocenosis* — is a group of populations of organisms from different species that are historically related with each other and with a definite residential territory. There is a constant exchange of substances, energy and information between populations and the environment. All biocenoses compose a biosphere — an area of the planet occupied by living organisms.

2. Methods of studying living things (methods of biological sciences).

Integral understanding of living matter can be obtained only by complex investigation of life at all organization levels. It is the subject of **Biology** and a number of special disciplines (**biological sciences**).

Biochemistry, Biophysics and Molecular Biology study life manifestations at a molecular-genetic level; **Cytology** — at a subcellular and cellular levels; **Histology** — at a tissue level.

Regulations of individual development and organisms structure are studied by **Embryology, Anatomy, Physiology**; historical development of living systems — by evolutionary study, **Paleobiology, Genetics, Biogeography, Systematization, Ecology**, etc. — study the population-specious, biogeocenotic and biospheric levels. All biological disciplines are closely connected and are a basis for the development of other branches of national economy, selection, veterinary science and medicine. Meanwhile every science uses a great range of methods to solve topical problems: observation, description, modeling and experimentation.

3. The significance of Biology for medicine.

Studying biology is of great significance for training doctors. Using methods of biological modeling, they study mechanisms of etiology and development of many human diseases, elaborate ways of their prevention and treatment. To study the biology of parasites is necessary for successful fighting against invasive diseases. Genetic engineering (genetic designing of cells and organisms with definite characters) and biotechnologies (technological processes using living organisms) helped setting up the production of antibiotics, interferon, some hormones and enzymes, many vitamins. Methods for determining the structure of human genes will allow using genotherapy of hereditary diseases in future.

4. The position of the human in the animal world system.

The human as a biologic species refers to the phylum of *Chordates*, sub-phylum of *Vertebrates*, class of *Mammals*, subclass of *Placentals*, order of *Primates*, suborder of *Anthropoids* (narrow-nosed apes), family of *Hominids* (humans), genus of *Homo* (man), species of *Homo sapiens* (a reasonable man).

5. Humans as biological and social beings. Humans have characters both of biological and social beings (tab. 1).

Table 1
Similarity of humans and animals

No	Systemic group of animals	Signs characteristic of humans
1.	Phylum — Chordates	Germination of axial organs occurs in the embryonic period: a chord, nervous tube, gastric tube
2.	Subphylum — Vertebrates	The chord transforms into the spine, the heart is on the abdominal side. There are 2 pairs of extremities, 5 departments of the brain, jaws
3.	Class — mammals	4-chamber heart, warm-bloodiness, well-developed cerebral cortex, mammary glands, presence of hair on skin coverings
4.	Subclass — Placentals	Development of human fetus in the mother's womb and its feeding through the placenta
5.	Order — Primates	The thumb of the upper extremities is opposed to the others, nails on fingers, one pair of mammary glands, well-developed clavicles, teeth of three types and replacement of milk teeth by permanent ones, giving birth to one child in the majority of cases

The following **signs** are characteristic only of the species of *Homo sapiens*: straight walking, apparent thumb opposition, S-shaped spine, the brain volume of 1100–1700 cm³, prominence of the chin, abstract thinking, speech, producing tools, etc. The progress of humankind obeys social laws — laws of the society. The human life is impossible outside the society. Social factors have played a great role in human development. Knowledge, skills and spiritual valuables are transferred in the society through training and education of young generations.

Basic terms and concepts:

1. Self-regulation — is the ability of the organism to modify parameters of vital activity according to environmental changes.

2. Self-renewal — is the ability of the organism to restore or change its structural-functional components.

3. Self-reproduction — is the ability of the organism to reproduce its own selves.

4. Systemic position of *Homo sapiens* — the position of the human in the animal world system.

5. A phylogenetic tree — is a tree-shape diagram, which presents relative and historic relations between systemic groups.

MAGNIFYING DEVICES. METHODS OF STUDYING CELLS

1. The subject, tasks and methods of cytology. Cytology (Latin *cytos* — a cell, *logos* — a science) — is a science studying the structure, chemical composition and functions of cells, their multiplication, development and interaction in a multicellular organism.

The tasks of cytology:

- studying the structure and function of cells and their components (membranes, organoids, inclusions and nucleus);
- studying cellular division and possibilities of their adaptation to environmental changes;
- studying interrelations between cells in a multicellular organism.

Methods of cytology:

1. *Microscopic* — they help study morphology of cells and their components (the methods of light and electron microscopy).

2. *Cytochemical (histochemical)* — they help determine the chemical composition or localization of substances in the cell (in tissue sections). They are based on special staining stuff.

3. *Biochemical* are used for studying the chemical composition of cells, determination of substance concentration in tissues. They are based on the property to absorb light waves of a definite length by different biochemical compounds.

4. *The method of differential centrifugation* helps study the composition and properties of cellular organoids: a tissue specimen is fragmented to destroy cellular membranes, then placed into the centrifuge, where it is divided into separate fractions.

5. *The method of autography* is used for studying the dynamics of metabolic processes in cellular structures. It means the introduction of radioactive isotopes into the cell. Molecules marked with radioactive isotopes (^3H , ^{32}P , ^{14}C) participate in exchange reactions. Their localization, movement, accumulation and excretion are determined by radiation registered with a photoplate.

6. *Rhoentgenostructural analysis* is performed for studying the spacious structure and arrangement of molecules in the substance. This method is based on diffraction of R-rays passing through a substance crystal.

2. Magnifying devices and their purpose. The light microscope arrangement.

A biological microscope is intended for studying micro-objects in the flow of passing light. A light microscope (fig. 1) consists of 3 parts: mechanical, illuminating and optical.

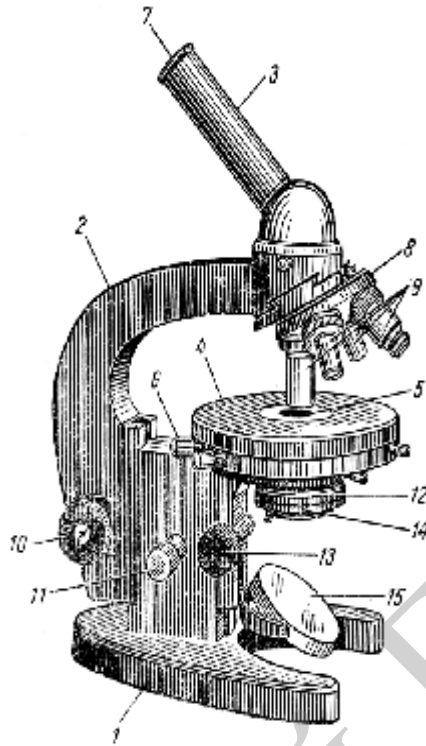

Fig. 1. The structure of a light microscope:

1 — a base; 2 — a draw-tube holder; 3 — a draw-tube; 4 — a stage; 5 — an aperture of the stage; 6 — screws for moving the stage; 7 — an ocular; 8 — a revolving device; 9 — objectives; 10 — a cremaliera; 11 — a micrometric screw (in some models it is located on the base); 12 — a condenser; 13, 14 — a screw and diaphragm of the condenser respectively; 15 — a mirror

The *mechanical* part includes a stand, a stage, a cremaliera (a macrometric screw), a micrometric screw, a draw-tube and a revolver.

The support consists of a draw-tube holder (column) and a base. The column contains:

- a revolver — a rotating mechanism for changing objectives;
- a draw-tube — a hollow tube for fixing an ocular;
- a system of screws for rough (macrometric) and fine (micrometric) adjustment of the microscope;
- a stage for placing an investigation object.

The *illuminating* part includes a mirror (or an electric illuminator) and a condenser.

The *mirror* of the microscope is double-sided — with a convex and concave surface. A concave surface is used under natural illumination, while a flat one — under artificial illumination.

The condenser is a lens system collecting light rays into a band. The light band diameter can be regulated with a special level, changing the diaphragm lumen.

The *optical* system consists of an ocular and objectives.

The *ocular* (*oculus* — an eye) is a lens system directed towards the eye. Magnification is indicated on the ocular mount. A teaching microscope uses spare oculars with magnification $7\times$, $10\times$ and $15\times$.

The *objective* is located at a lower end of the draw-tube — it is a lens system directed to the investigated object. Two kinds of objectives are used: with small magnification ($8\times$) and a large one ($40\times$).

The total magnification of the microscope is determined by multiplying the multiple of the objective and ocular magnifications. For example, the total magnification of the microscope with $40\times$ objective magnification and $7\times$ ocular magnification will be equal to 280.

3. Rules of working with the microscope:

1. Put the microscope column towards yourself and the mirror towards the light origin; approximately a palm width from the stage edge.

2. Set the objective 2–3 cm from the surface of the stage rotating the *macrometric* screw.

3. Check the adjustment of the objective with small magnification ($8\times$) until it «clicks», it should be fixed opposite the aperture on the stage.

4. Put the condenser into a neutral position and open the diaphragm completely.

5. *Looking into the ocular*, direct the mirror surface to the light source for even illumination of the *field of vision*.

6. Place the micropreparation on the stage, the cover glass should be directed towards the objective!

7. *Looking on the side* (!), lower the objective 0,5 cm from the surface of the cover glass with a macrometric screw (the focal distance of the objective with $8\times$ is *about 1 cm*).

8. Looking into the ocular, rotate *the macrometric screw towards «yourself»* slowly (!) and get a clear image of the object.

9. Study the object. Move the preparation manually.

Note: If the object is too small and is not seen at small magnification, then adjust the microscope to an edge of the cover glass. Having obtained a clear image of the glass edge, move it further to a working field in search of the object.

Rules of working with a large magnification (7×40) microscope:

1. Get a clear object image at small magnification (see above).

2. Center the needed area of a micropreparation — move it to the center of the field of vision.

3. Rotate the objective with large magnification ($\times 40$). using a revolver until it «clicks».

4. Put the condenser into an upper position. Looking from the side, *carefully* lower the large magnification objective with the macrometric screw until it touches the surface of the cover glass (the focal distance of $40\times$ objective is approximately 1–2 mm).

5. Looking into the ocular, turn slightly a *macrometric screw* «towards yourself» (!) until the object outlines appear.

6. Use a *micrometric screw* for getting a better image turning it towards yourself or from yourself *no more than 0,5 turn*.

7. Study the needed area of the micropreparation.

Terminating the work with the microscope:

1. Having finished studying the object, raise the draw-tube 2–3 cm with a macrometric screw and take off the preparation off the stage.

2. Set a small magnification objective until it «clicks» by turning the revolver and fix it against the aperture on the stage.

3. Lower the objective to the stage level with a macrometric screw.

Basic terms and concepts:

1. **Immersion** — liquid that fills the space between the cover glass and the immersion objective (90×).

2. **Condensor** — is a lens system collecting light rays into a bundle.

3. **Cremaliera** — is a macrometric screw.

4. **Objective** — is a lens system, which are screwed into the revolver and are directed to the stage.

5. **Ocular** — is a lens system inserted into an upper aperture of the draw-tube and directed to the eye.

6. **Resolution** — is the ability of the optic device to differentiate small details: a minimum distance between two adjacent points (lines), which are possible to differentiate.

7. **Revolving mechanism** — is a rotating mechanism for changing objectives, which is fixed on the column of the support.

8. **Draw-tube** — is a hollow tube, which connects the ocular and the objective.

BIOLOGY OF THE CELL. THE FLOW OF SUBSTANCE AND ENERGY IN THE CELL

1. The present state of the cellular theory.

1. The cell — is an elementary structural-functional and genetic unit of all living things, open self-regulating system, through which flows of substances, energy and information pass (fig. 2).

2. Cells of all organisms have similar structure, chemical composition and processes of vital activity.

3. New cells form, when the mother cell divides.

4. Cells of a multicellular organism differentiate and form tissues for performing various functions.

2. Differentiating signs of pro- and eukaryotic cells (tab. 2).

Pro- and eukaryotic cells

Prokaryotes	Eukaryotes
Differences	
Mycoplasmas, bacteria, cyanobacteria	Protists, plant and animal cells
Sizes: 1–10 μm	10–100 μm
There is no nucleus, but a nucleoid	There is a formed nucleus
DNA is not linked with proteins-histones	DNA is linked with proteins-histones
There is no mitosis and membrane organoids, their functions are performed by mesosomes — drawings-in of the cellular membrane	There is mitosis and membrane organoids (fig. 3)

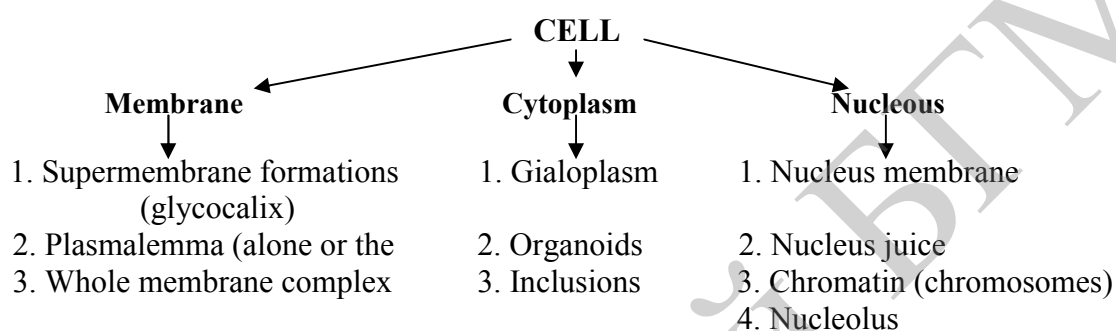

Fig. 2. The diagram of the cell structure

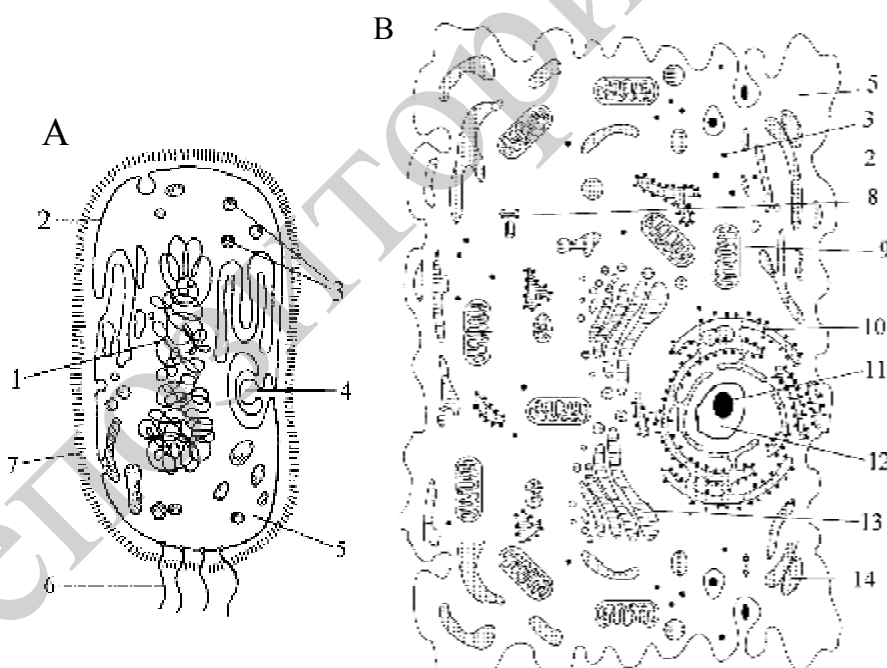

Fig. 3. The structure of a prokaryotic and eukaryotic cells:

A — prokaryotic cell, *B* — eukaryotic cell: 1 — a nucleoid; 2 — plasmalemma; 3 — ribosomes; 4 — a mesosome; 5 — cytoplasm; 6 — a filament; 7 — a cell wall; 8 — a cell center; 9 — a mitochondria; 10 — a granular EPR; 11 — a nucleolus; 12 — a nucleus; 13 — Golgi's complex; 14 — a smooth EPR

3. The structure of (a model) elementary membrane, its properties and functions.

In 1943 N. Dowson and P. Danielli proposed the first model of an elementary membrane. It was a «sandwich» model. Two layers of lipid molecules are located between two layers of protein molecules. Every lipid molecule has two ends — *hydrophilic* (water-soluble) and *hydrophobic* (water insoluble). Hydrophobic parts of molecules are directed towards each other, hydrophilic ones — towards proteins.

A fluid-mosaic model is better; it meets the requirements of properties and functions of an elementary membrane. It was proposed in 1972 by S. Singer and G. Nikolson. The basic membrane components — lipids — compose from 20 to 80 % of its mass. They are phospholipids, lecithin and cholesterol. Protein molecules are in a double layer of lipid molecules that form a «lipid sea». Protein molecules, which penetrate 2 layers of lipid molecules, are *integral*. Those protein molecules, which are immersed into one layer, are *semi-integral*. *Peripheral proteins* are on the surface of lipids. The third component of an elementary membrane — are *glycoproteins* and *glycolipids* forming a receptor apparatus on its surface (*glycocalix*).

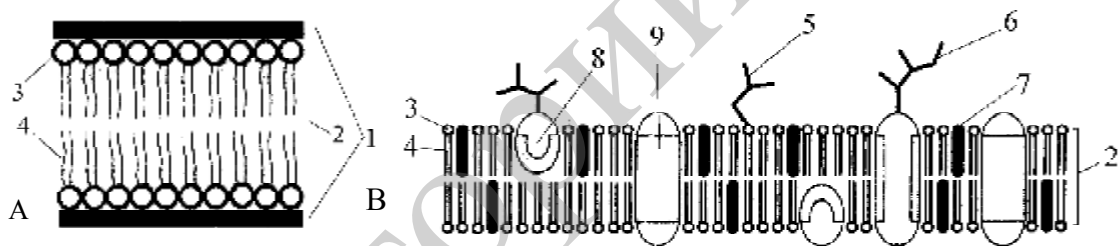

Fig. 4. The diagram of elementary membrane models:
A — sandwich, B — fluid-mosaic: 1 — solid protein layers; 2 — a bilipid layer; 3 — hydrophilic heads of phospholipids; 4 — hydrophobic tails of phospholipids; 5 — glycolipid; 6 — glycoprotein; 7 — cholesterol; 8 — semi-integral protein; 9 — integral protein

Properties of the elementary membrane:

- plasticity (it restores quickly after impairment and also stretches and constricts in cellular movements);
- semi-permeability (passes molecules selectively);
- ability for self-locking (vesicles and vacuoles are formed).

Functions of the elementary membrane:

- structural (membranes are included into the composition of all cellular organoids except ribosomes and centrosomes);
- barrier (protects the cell from external factors and sustains its composition);
- metabolic (many enzymes are located on membranes);
- receptor (receives signals, recognizes substances).

4. Methods of passing substances into the cell:

1. *Passive transport* follows the concentration gradient without spending energy. Water and small molecules can pass into the cell by filtration, diffusion, through pores or in the process of solution in lipids.

2. *Lighted diffusion* is associated with participation of proteins-transmitters in transferring molecules — permeasis. Amino acids, sugar, fatty acids get into the cell in this way.

3. *Active transpopt* demands energy expenditure, because it follows against the concentration gradient. Such transport demands enzymes, ATP molecules and formation of special ion canals. A sodium-potassium pump is an example of such transport.

4. *Endocytosis* — is participation of the membrane itself in catching particles or molecules and transporting them into the cell. *Endocytosis* — is a modified architectonics (outlines) of the membrane. Transport of macromolecules or hard particles is *phagocytosis*, while transport of fluid is *pinocytosis*.

5. **The cell anabolic system.** The cell anabolic system performs reactions of plastic exchange or assimilation.

Organoids — are differentiated areas of the cytoplasm. They have a constant structure and perform specific functions.

Ribosomes — are spherical bodies (15–35 nm in diameter) consisting of two subunits. They may be in hyaloplasm, on the external nucleous membrane, on membranes of the endoplasmatic net. A *large subunit* of the ribosome contains three different molecules r-RNA and 40 molecules of proteins, a *small subunit* — one r-RNA molecule and 33 protein molecules. Ribosome subunits are synthesized in nucleoli. The information about the r-RNI structure is contained in «*nucleoli-organizers*» (DNA molecule areas in the region of secondary constrictions of satellite chromosomes). The final assembly of ribosomes in subunits occurs in the process of translation.

The function of ribosomes is assembling protein molecules (translation).

Endoplasmatic reticulum (EPR) — are canals located throughout the cell and connected with the perinuclear space of the nucleus and cavities of Golgi's complex. A canal wall is an elementary membrane. EPR canals perform the function of compartmentalization of the cell cytoplasm, its division into areas, where various biochemical reactions take place. The granular EPR (ribosomes are placed on its membranes) participate in protein biosynthesis, which are later transported to Golgi's complex.

Carbohydrates and lipids are synthesized on membranes of a smooth EPR (does not contain ribosomes). It takes part in synthesizing steroid hormones, in detoxication of toxic substances (liver cells).

Golgi's complex consists of vesicles, tubules, sacs. Dictyosomes are basic elements of the complex.

Dictyosomes — are piles of closed sacs of 10–15 elementary membranes that have dilations on the ends. These dilations form vesicles that separate and transform into lysosomes and vacuoles. Part of these vesicles excrete secreted and metabolites from the cell.

Functions of Golgi's complex:

- sorting and packing substances synthesized in EPN;
- synthesizing complex compounds (lipoproteins, glycoproteins);
- assembling elementary membranes;
- forming lysosomes, glyoxisomes and vacuoles;
- taking part in substance secretion.

6. The cell catabolic system. The cell catabolic system performs energy exchange or dissimulation.

Primary lysosomes form in Golgi's complex. They are rounded bodies (0,2–0,2 μm in diameter) covered with an elementary membrane. They include approximately 50 different hydrolytic enzymes. *Secondary lysosomes* (phagolysosomes) contain breakable substances.

Functions of lysosomes:

- breaking up substances passed into the cell in phagocytosis;
- destroying impaired structures and organoids of the cell.

Peroxisomes are formed in EPN. Their enzymes (oxidases) oxidize amino acids with formation of peroxide (H_2O_2).

Glyoxisomes are formed in Golgi's complex, their enzymes transform fats into carbohydrates.

Mitochondria have a shape of rods, filaments and granules. The size of mitochondria is from 0,5 to 7 μm . Their number is not the same in cells with different activity. A mitochondrion wall has an external and internal membrane. Projections of the internal membrane form *crysts*, between which is an internal matrix containing enzyme systems of an oxygen stage of energy exchange and an autonomous system of protein biosynthesis (ribosomes, RNA and ring DNA molecules). The interspace between mitochondrion wall membranes is filled with perimitochondrial *space*.

Functions of mitochondria:

- ATP synthesis;
- Synthesis of specific proteins and steroid hormones.

7. Energy exchange in the cell. Fermentation systems of mitochondria.

Energy exchange is the sum of fermentation breaking-down reactions of complex organic compounds followed by releasing energy used for ATP synthesis.

The preparatory stage goes in the digestive system and in phagosomes of cells, where complex organic compounds break down into simple ones: polysaccharides to monosaccharides, proteins to amino acids, fats to glycerol and fatty acids. The released energy is dissipated as warmth.

The Anaerobic stage (glycolysis) occurs in the cytoplasm of cells. Ten enzymes participate in it. Glucose breaks down to pyruvic (lactic) acid and 2 ATP molecules form. The pyruvic acid passes into mitochondria for further transformations.

Aerobic stage of energy exchange occurs in mitochondria.

There are 3 fermentation systems in mitochondria:

- Krebs cycle (of citric acid) — in the internal matrix;
- tissue respiration — on the internal membrane;
- oxidation phosphorylation — ATP-somes (mushroom-shaped bodies).

Pyruvic acid comes into the internal matrix of the mitochondrion and interacts with co-enzyme A (CoA), when Acetyl CoA (an activated form of Acetic acid) forms. CO_2 and H^+ chip off Acetyl CoA. CO_2 is excreted by mitochondria, and H^+ and e^- (from hydrogen atoms) pass to the enzyme system of tissue respiration. Protons accumulate on the external surface of the internal membrane and electrons — on the internal one. Having reached a critical potential (200 mv), protons pass through canals into ATP-somes. Electrons give the energy away for adding the rest of phosphoric acid to ADP (ATP synthesis) and they join protons. Hydrogen atoms are formed, they mix with oxygen and form water molecules. 38 mol of ATP from 1 mol of glucose are formed as a result of all reactions of energy exchange.

Basic terms and concepts:

1. **Glycocalyx** — is a receptor apparatus of an animal cell membrane.
2. **Glycolysis** — is a process of breaking down glucose without oxygen.
3. **Glyoxisomes** — are organoids, where transformation of fats into carbohydrates takes place.
4. **Concentration gradient** — is the difference of substance concentrations.
5. **Mesosomes** — are drawings-in of prokaryotic cells plasmalemma, which perform a role of membrane organoids.
6. **Nucleoid** — is a genetic apparatus of prokaryotes.
7. **Peroxisomes** — are organoids, where oxidation of amino acids occurs and peroxide is formed.
8. **Plasmalemma** — is a membrane, which is included into the cell membrane.
9. **Enzymes of oxidizing phosphorylation** — are enzymes of mitochondria localized in ATP-somes.
10. **Enzymes of tissue respiration** — are enzymes of mitochondria localized in crysts.
11. **Enzymes of Krebs cycle** — are enzymes of mitochondria localized in the matrix.

TEMPORAL ORGANIZATION OF THE CELL

1. The structure and functions of the nucleus.

The basic genetic information is in the nucleus. The nucleus (Latin — *nucleus*; Greek — *karyon*) was described in 1831 by R. Brown. The shape of the nucleus depends on the shape and functions of the cell.

The *membrane* of an interphase nucleus (*karyolemma*) consists of an external and internal elementary membrane. A *prenuclear space* is between them. There are openings in membranes, *pores*. Protein molecules forming *porous complexes* are in the pores. When the cell is active, the majority of pores are open. The substance flow passes through them from the cytoplasm into the nucleus and back. The number of pores in one nucleus reaches 3–4 thousand. The external nucleus membrane is linked with endoplasmic net canals. *Ribosomes* are usually placed on it. Proteins of the internal nuclear membrane form a *nuclear plate*. It sustains a constant shape of the nucleus and chromosomes are attached to it.

Nuclear juice — is *karyolymph*, a colloid solution in a jelly-like state, that contains proteins, lipids, carbohydrates, RNA, nucleotides, enzymes.

Nucleolus — is a temporary component of the nucleus: it disappears in the beginning of cellular division and restores in the end of it. Chemical composition: protein (~90 %), r-RNA (~6 %), lipids, enzymes. Nucleoli form in the area of secondary constrictions of satellite chromosomes. Function: assembling ribosome subunits.

Chromatin of the nucleus — interphase chromosomes. They contain DNA, proteins-histones and RNA in ratio 1:1,3:0,2. DNA together with protein form *desoxiribonucleoprotein* (DNP). DNP spirals and forms chromosomes during mitotic division of the nucleus.

Functions of the nucleus:

- 1) forms hereditary information of the cell;
- 2) takes part in cellular division (multiplication);
- 3) regulates metabolic processes in the cell.

2. Types of chromosomes. The structure of a metaphasal chromosome.

Chromosomes (Greek — *chromo* — color, *soma* — body) — is spirals chromatin. The chromosome length is 0,2–5,0 μm , diameter — 0,2–2,0 μm .

A metaphasal chromosome consists of 2 *chromatids*, that are linked with a *centromere* (*primary constriction*). It divides the chromosome into 2 *arms*. Some chromosomes have *secondary constrictions*. The area they separate is a satellite, and such chromosomes are called satellite. Terminal areas of chromosomes are telomeres. Each chromatid includes one DNA molecule together with proteins-histones. Chromosomal areas with intense staining are areas of strong spirals (*heterochromatin*). Lighter areas — are areas of weak spirals (*euchromatin*).

Types of chromosomes according to the centromere position:

1. *Metacentric* — the centromere is in the middle, the arms are of identical length.
2. *Submetacentric* — the centromere is biased from the center, the arms are of different length.
3. *Acrocentric* — the centromere is far from the center, one arm is very short, and the other — very long.

One can meet gigantic, *polytenous chromosomes* (polyfilament chromosomes) in cells of insects (*Drosophila*) salivary glands.

There are 4 rules for chromosomes of all organisms:

1. *The rule of a constant number of chromosomes*. Organisms have a constant characteristic of the species number of chromosomes. For example, in the human — 46, in the dog — 78, in *Drosophila* — 8.
2. *Parity of chromosomes*. In norm, every chromosome in a diploid complement has a paired chromosome — identical in shape and size.
3. *Individuality of chromosomes*. Chromosomes of different pairs differ in shape, structure and size.
4. *Continuity of chromosomes*. When genetic material is doubled, a chromosome originates from a chromosome.

Chromosomal function: storing, reproduction and transmission of genetic information, when cells and organisms multiply.

3. Cellular and mitotic cycles. There is a cellular and mitotic cycle in life of cells.

Cellular or life cycle of the cell — is a period from the appearance of the cell until its death or to the end of next cellular division. *The period of life cycle of somatic cells*: growth and differentiation, performing specific functions, preparation for division (multiplication), division. A mitotic cycle is characteristic of the majority of cells — a period of its preparation for division (interphase) and the division itself (mitosis).

4. Interphase, characteristic of periods. Reasons of mitosis.

The interphase includes three periods: G_1 — *pre-synthetic (post-mitotic)*, S — *synthetic* and G_2 — *post-synthetic (pre-mitotic)*. The content of genetic material in the cell changes during the interphase: n — a haploid complement of the chromosome, chr — the number of chromatids in the chromosome, c — the number of DNA complements.

Pre-synthetic period. The cell grows, performs its functions. RNA, proteins, DNA nucleotides are synthesized in it, the number of ribosomes increases, ATP accumulates. The period lasts 12 hours but it may take several months. The content of genetic material — $2n \mid chr \ 2c$.

During the *synthetic period*, replication of DNA molecules occurs — each chromatid adds one more identical to itself. The content of genetic material becomes $2n2chr4c$. Centrioles duplicate. RNA, ATP and proteins-histones are syn-

thesized. The cell continues performing its functions. The duration of the period is up to 8 hours.

During the *post-synthetic period* energy of ATP accumulates; RNA, nuclear proteins and proteins-tubulines necessary for chromatin division spindle are actively synthesized. The content of genetic material does not change: $2n2chr4c$. By the end of the period all synthetic processes become slower, the cytoplasm viscosity changes.

Reasons of mitosis:

- changing of the nuclear-cytoplasmic ratio from $1/6-1/7$ to $1/69-1/89$;
- the presence of «mitogenetic rays» which stimulate division of adjacent cells;
- action of «wound hormones», which determine impaired cells and stimulate division of unimpaired cells.

5. Characteristic and significance of mitosis.

The basic method of dividing somatic cells is mitosis. Mitosis has four stages: a prophase, metaphase, anaphase and telophase.

The *prophase* starts with spiralization of chromatin: long chromatin filaments are shortened and thickened forming chromosomes. Centrioles diverge to cell poles; filaments of the division spindle are formed. Nucleoli and nuclear membrane dissolve, the nucleus volume enlarges. The content of genetic material is $2n2chr4c$.

The metaphase: chromosomes are located at the cell equator forming a *metapasal plate*. Filaments of the division spindle are attached to the center of chromosomes. One can see that each chromosome consists of two chromatids. The content of genetic material does not change — $2n2chr4c$.

Anaphase. Filaments of the division spindle constrict. In the region of centermeres, chromosomes are divided into two chromatids. The chromatids diverge to cell poles. They are daughter chromosomes. The content of genetic information at each pole of the cell — $2n$ I $chr2c$.

During the *telophase* the formation of daughter nuclei continues. Nuclear membranes are formed, chromosomes are despiralized, loose their clear outlines and nucleoli are restored. The final stage of mitosis is cytokinesis (division of the cytoplasm). The cellular membrane is formed by fusion vesicles of the endoplasmatic net. Two cells are formed, the content of genetic material of which — $2n$ I $chr2c$.

The significance of mitosis:

- sustaining the constancy of the chromosome number, providing genetic succession in cellular populations;
- even distribution of chromosomes and genetic information between daughter cells.

6. Characteristic and significance of meiosis.

Meiosis is a variety of mitosis. Meiosis is division of somatic cells of gonads that leads to the formation of gametes. Meiosis consists of two divisions — meiosis I and meiosis II. Each division has four phases: prophase I and prophase II, metaphase I and metaphase II, anaphase I and anaphase II, telophase I and telophase II.

The prophase of meiosis I is most complicated. It has 5 stages:

1. *Leptotena*: chromatin spirals forming thin chromatin filaments that start moving to each other with centromere parts; genetic material — $2n2chr4c$.

2. *Zygotena*: *conjugation* of short and thick chromatin filaments (chromosomes) starts, they join along the whole length; genetic information does not change — $2n2chr4c$.

3. *Pachitena*: homologous chromosomes are tightly joined along the whole length; the formed figures are *bivalents* of chromosomes or *tetrads* of chromatids; genetic material can be recorded as $ln_{biv}4chr4c$; by the end of the stage antagonizing forces start acting in the area of centromeres and *crossing-over* occurs, exchange of homologous chromosomes parts.

4. *Diplotena*: antagonizing forces continue their action, but chromosomes stay joined in the area of chiasm (crossings); the content of genetic material is preserved — $ln_{biv}4chr4c$;

5. *Diakinesis*: chromosomal spiralization finishes, the nuclear membrane and nucleolus disappear; chromosomal bivalents linked with their ends come into the cytoplasm and move towards the center of the cell; filaments of the division spindle attach to centromeres of chromosomes; $ln_{biv}4chr4c$.

In the **metaphase of meiosis I**, bivalents are located along the equator of the cell; separate chromosomes are clearly seen; genetic material — $ln_{biv}4chr4c$.

Anaphase I: bivalents are divided into homologous chromosomes. Filaments of the division spindle constrict, that is why chromosomes diverge to cell poles. Each chromosome still contains 2 chromatids. The content of genetic material at each cell pole — is $ln2chr2c$. During this phase the reduction (decrease) of the number of chromosomes occurs — a diploid complement of chromosomes becomes a haploid one.

In the **telophase of meiosis I**, cytokinesis takes place, and two-daughter haploid cells form — $ln2chr2c$; unlike mitosis in this phase, despiralization of chromosomes does not occur.

After meiosis I comes **interkinesis** — a short interval between two divisions. DNA replication does not occur. Interkinesis is followed by meiosis II.

Meiosis II almost does not differ from mitosis. In prophase II, spiralization of chromosomes ($ln2chr2c$) does not occur, and in anaphase II chromatids but not chromosomes diverge to cell poles. Each daughter cell gets a complement of genetic information $ln1chr1c$.

During meiosis one mother haploid cell forms 4 cells (gamets) with a haploid complement of chromosomes.

The significance of meiosis: it is a mechanism of gamete formation; it sustains the constancy of the number of chromosomes; provides combinative variation.

7. Amitosis. During amitosis chromatin is not spiralized and the division spindle is not formed. The nucleus and cytoplasm are divided by constriction into two. Usually amitosis divides epithelial cells of mucous membranes, cancer cells (genetic information there may be distributed unevenly) and cells participating in regeneration. Amitosis can lead to the formation of multinuclear cells (the nucleus has divided, but the cytoplasm has not).

Basic terms and concepts:

1. Bivalents — two homologous chromosomes, conjugated with each other during the prophase of meiosis I. Their number is equal to a haploid complement of chromosomes.

2. Karyolymph — nuclear juice.

3. Cellular cycle — is a period from the appearance of the cell to its death or to the end of next cellular division.

4. Conjugation of chromosomes — linkage of homologous chromosomes in length.

5. Crossing-over — is exchange of identical parts of chromatids of homologous chromosomes in pachitena of the prophase of meiosis I.

6. Meiosis — is division of somatic cell of gonads, when gametes are formed.

7. Mitotic cycle — is a preparation period of the cell for division (interphase) and division itself (mitosis).

8. Telomeres of chromosomes — terminal parts of chromosomal arms.

9. Chiasms — cross of chromatids of homologous chromosomes in conjugation.

10. Chromatin — is a complex consisting of DNA and histone proteins

11. Nuclear-cytoplasmatic ratio — is a physiologically and morphologically regular ratio of the mass (volume) of the nucleus to the mass (volume) of the cytoplasm in every cell.

BASES OF CYTOGENETICS

1. The concept of karyotype and ideogram.

Karyotype is a diploid complement of chromosomes of a somatic cell characteristic of the organism of a definite species.

The human karyotype contains 46 chromosomes. Chromosomal pairs, identical in males and females, are autosomes. There are 22 such pairs in the human.

One pair of chromosomes, which differentiates male and female organisms, are *heterochromosomes* or *sex chromosomes*. In males they are X and Y and in females — X and X.

The arrangement of chromosomes in descending order of their sizes is an ideogram. It is a systematized karyotype, where homologous chromosomes are arranged in pairs.

2. Methods of studying the human karyotype.

Cytogenetic method. It studies the karyotype by microscope. Stages of the method:

1. Obtaining cells (blood lymphocytes, skin fibroblasts).
2. Cultivating cells on artificial culture.
3. Adding PHA (phytohemagglutinin) for stimulating mitosis.
4. Stopping the cellular division in the metaphase by colchicine, which impairs the mitotic apparatus.
5. Treating cells with NaCl hypotonic solution (the cell is broken and chromosomes become accessible for staining).
6. Staining chromosomes with specific stains.
7. Microscoping and making photographs of chromosomes.
8. Compiling an ideogram and analyzing it.

The method is used for diagnosing genomic and chromosomal mutations, to determine a genetic sex of the organism.

The autographic method is used for identification of chromosomes.

The fluorescent method is used to confirm the karyotype and to map chromosomes.

3. The Denver and Paris classification of human chromosomes.

In 1960 the Denver classification of chromosomes was proposed. It is based on the shape of chromosomes, their sizes, position of the centromere, presence of secondary constrictions and satellites. An important factor of this classification is a *centromeric index* (CI). It is a ratio of a short chromosomal arm to its full length, expressed in per cents. All chromosomes are divided into 7 groups. The groups are denoted with Latin letters from A to G:

- *group A* includes 1th–3th pairs of chromosomes. They are large metacentric and submetacentric chromosomes. Their CI is 38–49 %.
- *group B*. 4th and 5th pairs of chromosomes — large submetacentric chromosomes. CI is 24–30 %.
- *group C*. 6th–12th pairs of chromosomes: of a moderate size, submetacentric, CI is 27–35 %. X-chromosome is also included into this group.
- *group D*. 13th–15th chromosomes. They are acrocentric. CI is about 15 %.
- *group E*. 16th–18th pairs of chromosomes. They are relatively short, metacentric or submetacentric. CI is 26–40 %.
- *group F*. 19th–20th pairs. Short, submetacentric chromosomes. CI is 36–46 %.

– *group G*. 21st–22nd pairs. Small, acrometacentric chromosomes. CI is 13–33 %. An Y-chromosome refers to this group.

The Paris classification of human chromosomes was introduced in 1971. A characteristic order of alternating dark and light bands (segments) is revealed in every chromosome using specific staining methods. The segments are denoted by the names of methods, which reveal them: Q-segments — after staining with acrichine-yperite; G-segments — with Gimza stain; R-segments — staining after heat denaturation, etc.

A short arm of the chromosome is denoted with *p*, a long one — with the letter *q*. Each chromosomal arm is separated into areas and is denoted with figures from centromere to telomere. Bands within the areas are numbered from the centromere. For example, the gene position of D esterase can be denoted as *13p14* — the 4th band of the 1st region of a short arm of chromosome 13.

Basic terms and concepts:

1. Autosomes — are chromosomes identical in cells of male and female organisms.

2. Karyotype — is a chromosomal complement of a somatic cell characteristic of the organism of a definite species.

3. Colchicine — is a substance used for destroying the division spindle, when a cytogenetic method is used.

4. Sex chromosomes — are chromosomes different in cells of male and female organisms. In males they are X and Y chromosomes, in females — X and X.

5. Phytohemagglutinine — a substance, which is used for stimulation of mitosis in the cytogenetic method.

6. Centeromeric index (CI) — is a ratio of a short arm length of the chromosome to its full length expressed in per cents.

ORGANIZATION OF HEREDITARY MATERIAL

CLASSES I

1. Nucleic acids (DNA and RNA): the structure and functions. Chargaff's rules.

In 1870 I. Misher described macromolecule in nucleus and called them **nucleic acids** (from Latin *nucleus* — nucleus). DNA (deoxyribonucleic acid) and RNA (ribonucleic acid) refer to nucleic acids. The structure of a DNA molecule was decoded in 1953 by J. Watson, F. Krik and M. Wilkinson.

The nucleic acids are biopolymers. Their monomers are *nucleotides*. A nucleotide consists of a nitrogenous base, 5-carbon sugar and residue of the *phosphoric acid*. Nitrogenous bases are of 5 types: adenine, guanine, cyto-

sine, thymine, uracyl. Nitrogenous bases are denoted: A, G — purine, T, C, U — pyrimidine. 5-carbon sugar — is *deoxyribose* or *ribose*.

The **DNA** molecule consists of two sequences which are interwoven as spirals. Each sequence is a polynucleotide. A DNA nucleotide consists of a nitrogenous base (adenine, guanine, cytosine and thymine), deoxyribose and a residue of the phosphoric acid. The nucleotide sequence is linked by *phosphodiester bonds* between deoxyribose of and the residue of the phosphoric acid of the other nucleotide. There are linked nitrogenous bases within the spiral; they are linked to each other according to the principle of *complementarity*: A = T — 2 hydrogen bonds G ≡ C — 3 hydrogen bonds.

The complementarity property of nitrogenous bases is expressed in Chargaff's rules:

– the number of purine bases is equal to the number of pyrimidine bases:
 $A + G = C + T$;

– the amount of adenine is equal to the amount of thymine (A = T), the amount of guanine is equal to the amount of cytosine (G = C).

The DNA is in the cellular nucleus, in mitochondria and plastids. DNA properties: *replication* (self-reproduction) and ability to *repair* (restoration of the structure after impairment of the molecule). DNA functions: storing and transmitting genetic information during multiplication of cells and organisms.

The **RNA** molecule is a polynucleotide consisting of one sequence. In comparison with a DNA it includes uracil instead of thymine and sugar ribose instead of deoxyribose. In some viruses, RNA has two sequences.

The cell has 3 types of RNA, they are in the nucleus, cytoplasm, mitochondria and plastids. 3–4 % of the whole RNA compose the *messenger RNA* (mRNA): it «records» the genetic information from DNA and translocates it into ribosomes — a place, where protein molecules are assembled. The *ribosomal RNA* (r-RMNA) composes 80–85 % of the whole RNA. It is included into ribosomes and provides special interposition of i-RNA and r-RNA. The *transport RNA* (t-RNA) comprises 10–20 % of the whole RNA, it transports (transfers) amino acids from the cytoplasm to ribosomes.

2. Proofs of the nucleic acids role in transmission hereditary information. Experiments on **bacteria transformations** (Griffith, 1929) became one of the proofs of the DNA role in transmitting hereditary information.

F. Griffith investigated the action of two bacterial strains on mice. Capsulated bacteria were pathogenic (virulent) and caused death of mice of pneumonia, unencapsulated ones were not pathogenic (avirulent), and mice stayed alive. When a mixture of alive avirulent and killed by boiling virulent bacteria was introduced into the organism of mice, the mice died. F. Griffith discovered the phenomenon of bacteria transformation — appearance of a capsule and virulence in unencapsulated bacteria. In 1944 year O. Every, K. McLeod and M. McCarty isolated a DNA capsule strain from bacteria; after addition of purified DNA of

a virulent strain to alive bacteria of avirulent strain they observed their transformation and formation of a capsule.

Bacteria transformation is the inclusion of bacterial DNA regions of one strain into DNA of the other strain and transmission of its properties.

The next proofs of the DNA role in transmitting hereditary information were experiments of N. Cinder and J. Lederberg (1952) on **transduction** in bacteria. Two strains of bacteria were placed into a U-tube with filter and culture: into one bend — triptophansynthesizing, and into the other bend — triptophanunsynthesizing.

The filter was unpermeable for bacteria and they did not mix, but it was permeable for viruses. If into the bend with triptophansynthesizing bacteria a bacteriophage was introduces, then some time later there were revealed bacteria (among triptophanunsynthesizing bacteria in the other bend), which were able to synthesize triptophan. The phenomenon was called transduction.

Transduction is the ability of a bacteriophage to transfer parts of DNA from one strain of bacteria to the other and transmit its properties.

3. Properties of genes.

The gene is a part of a DNA molecule coding a definite polypeptide. Genes are characterized by the following properties:

1. *Specificity* — a unique sequence of nucleotides for every structural gene.
2. *Integrity* — being a functional unit (programming of protein synthesis) the gene is integral.
3. *Discretion* — the gene includes two subunits: a muton — a subunit, which is responsible for mutations; a recon, which is responsible for recombination. Their minimum number — a pair of nucleotides.
4. *Stability* — genes are relatively stable. The frequency of unconditioned mutations of a gene is approximately 10^{-5} per a generation.
5. *Lability* — they can modify, mutate.
6. *Pleotropia* — multiple genic action (one gene is responsible for several characters).
7. *Expressivity* — the degree of phenotypical manifestation of the gene. It is due to environmental factors and effect of other genes.
8. *Penetration* — frequency of appearing the gene: a ratio (in percents) of the number of individuals having this character to the number of individuals having this gene.

4. DNA replication.

Genes perform two functions in the cell. A *heterosynthetic* function is programming of biosynthesis in the cell. An *autosynthetic* function — is replication of DNA (self-doubling of DNA).

Replication of DNA occurs in the synthetic period of the interphase. Synthesis of the DNA molecule is semi-conservative: one sequence is motherly («old»), a new daughter sequence («new») is assembled on it. The new sequence

is assembled according to complementarity of the mother sequence. The main enzyme of synthesis is a DNA-polymerase.

The spiral of a DNA molecule under the action of the DNA-helicase enzyme is unwinded by 2 sequences, each of them performs a matrix role. Replication starts in some points of the DNA molecule. The part of DNA from the start of one replication to the start of the other is a *replicon*. Chromosomes of eukaryotes have many replicons, those of bacteria nucleoid — 1 replicon. Doubling in all replicons goes simultaneously. A replication part is called a *replication fork*.

DNA-polymerase can move along the mother sequence only from 3' end to 5' end. That is why assembling of daughter sequences goes *anti-parallel* (in opposite directions). Several DNA polymerases work simultaneously in every replication fork. One of daughter molecule sequences (a leading one) is continuously duplicating. The second sequence (a retarding one) is duplicating with short parts of 150–200 nucleotides under the action of DNA-polymerase, which moves in opposite from the first enzyme direction. These parts are called *Oka-saki's fragments*. All synthesized fragments of a polynucleotide sequence are linked with a *lygase* enzyme. The whole genome of the cell is replicated once during a mitotic cycle.

5. The genetic code and its properties. Protein biosynthesis.

Recording of genetic information as a nucleotide sequence in DNA and mRNA is a *genetic code*. A nucleotide triplet coding a specific amino acid is a *codon*. The codon is an elementary functional unit of the gene.

Properties of the genetic code:

- *tripletness* — one amino-acid is coded by three nucleotides — a codon (triplet);
- *universality* — one and the same codon defines one amino acid in all organisms;
- *no overlapping* — one nucleotide is included only in one triplet;
- *degeneration*, or redundancy — one amino acid can be coded by several triplets (there are 20 amino acids, by 64 possible triplets);
- *discontinuity* — there are no disjunctive symbols between codons;
- *single direction* (*mRNA* synthesis occurs in the direction from 5' end to 3' end);
- *presence of codons-terminators* (they define the end of protein biosynthesis).

The correspondence of the order of nucleotides in a DNA molecule to the order of amino acids in the polypeptide molecule is **co-linearity**.

Protein biosynthesis in the cell. Protein biosynthesis is a fermentation process, where nucleic acids play the main role. MRNA is synthesized in the cellular nucleus on one of DNA sequences (coding). RNA-polymerase «transcribes» the order of nucleotides arrangement in a DNA molecule (by

complementarity rule). This process is called *transcription*. mRNA enters the cytoplasm through nucleous pores and directs to ribosomes.

Recognition (recognizing of its own amino acid by t-RNA) occurs in the cytoplasm. The transport RNA has a specific structure: one end of the molecule contains a nucleotide triplet, it is called an *anti-codon* and corresponds to a definite amino acid. The ribosome moves one triplet, and the amino-acyl-t-RNA passes into the peptide center. A definite amino acid joins «its own» t-RNA with the enzyme of *amino-acyl-tRNA-synthetase* and ATP. The amino acid with its t-RNA forms a complex of amino-acyl-t-RNA.

The process of *translation* is going on in ribosomes — a nucleotide sequence of mRNA defines the amino acid sequence of the polypeptide molecule. mRNA is linked with a small ribosome unit in the cytoplasm. The complex of ribosomes, united mRNA, is called a polysome. The beginning of translation is *initiation*, the end of translation — *termination*. The formation process of peptide links between amino acids is *elongation*. There are two mRNA codons in the ribosome simultaneously: one — the *amino-acylic center*, the second — in the *peptide* one.

If a t-RNA anti-codon and an mRNA codon, which is in the amino-acylic center, are complementary, then amino-acyl-t-RNA forms a temporary bond with an mRNA codon. The ribosome moves by one triplet, and the amino-acyl-t-RNA passes into the peptide center. The second t-RNA with the amino acid comes to the amino-acylic center. A peptide bond sets between the first and second amino acids. The ribosome moves by one triplet, the released t-RNA leaves the ribosome. The second t-RNA passes into the peptide center. The process repeats many times. Termination of polypeptide synthesis is determined by stop-codons: UAA, UAG, UGA.

7. The central dogma of Molecular Biology.

In 1958 F. Krik formulated the central dogma of Molecular Biology: DNA → RNA → protein. The genetic information, recorded in DNA, is realized in a form of proteins. This realization occurs through mRNA. DNA is synthesized on DNA providing its own replication.

In viruses, mRNA can be transcribed in DNA («back transcription»), but protein can not be a matrix for nucleic acids.

Basic terms and concepts:

- 1. Avirulent strain** — is a group of microorganisms that can not cause a disease.
- 2. Anti-codon** — is a t-RNA nucleotide triplet, which is complementary to an mRNA triplet in the process of translation.
- 3. Bacteriophage** — is a virus parasitizing on bacteria.
- 4. Virulent strain** — are microorganisms able to cause a disease.
- 5. Gene** — a fragment of a DNA molecule coding a definite polypeptide.

6. **Initiation** — an initial stage of translation.
7. **Codon** — a nucleotide triplet, the least functional unit of the gene.
8. **Complementarity of nitrogenous bases** — correspondence of nitrogenous bases to each other in a DNA molecule.
9. **Lability of the gene** — ability of the gene to mutate.
10. **Nucleotide** — a monomere of nucleic acids consisting of a nitrogenous base, sugar (pentose) and a residue of the phosphoric acid.
11. **Stability of the gene** — ability of the gene to preserve its structure.
12. **Termination** — finishing the polypeptide synthesis.
13. **Transduction** — transport of a DNA molecule fragment by a bacteriophage from one bacterial strain to the other.
14. **Transformation** — is the ability of a bacterial strain to occupy fragments of the other strain and obtain new properties and signs.
15. **Elongation** — is the process of translation from formation of the first peptide bond to joining the last amino acid.

CLASSES II

1. Levels of packing genetic material.

A DNA is linked with histone and non-histone proteins forming nuclear-protein fibrils (DNP). A fibril length in a human diploid chromosomal complement is 2 m, and a length of a chromosome in the metaphase is 150 μm . Packing of genetic material is obtained by spiralization (condensation) and four package levels of DNP.

Nucleosomal level. A nucleosome is a globule containing 2 histone molecules: $\text{H}_{2\text{A}}$, $\text{H}_{2\text{B}}$, H_3 , H_4 , around which a double DNA spiral forms 2,2 turns (200 pairs of nucleotides). The nucleosomal thread has $d = 10\text{--}13$ nm. The DNA length reduces by 5–7 times. This level is characteristic of the interphase.

Supernucleosomal level (solenoid). The nucleosomal thread condenses, nucleosomes are «sewn» by histone H_1 and a spiral is formed with $d = 25$ nm. One turn of the spiral contains 6–10 nucleosomes. DNA shortens 6-fold more. The supernucleosomal package level can be seen in the interphase and in mitosis.

Chromatid level. The super-nucleosomal filament is spiralized with formation of loops and twists and is the basis of a chromatid. The loop diameter equals to 50 nm. The DNP thread shortens by 10–20 times. Such package level can be seen in the mitosis prophase.

Metaphasal chromosome level. Chromatids are spiralized and form euchromatin (weakly spiralized) and heterochromatin (strongly spiralized) fragments; there occurs 20-fold shortening of DNP. The length of metaphasal chromosomes is from 0,2 to 150 μm , the diameter is 0,2–5,0 μm .

The total condensation of DNP is 10 000 times.

2. Classification of genes.

Classification of DNA sequences:

1. *Unique sequences* (solitary sequences in the genome are included into structural genes and carry information about the structure of polypeptides (they compose 56 % in the human genome).

2. *Repeated sequences* (are repeated ten, hundred, million times) — are promoters, they regulate DNA replication; participate in crossing-over, separate exons and introns in the transcripton.

3. *Transposones* («jumping genes») — are movable genetic elements able to invade the chromosome and to move within it.

According to their functions genes are classified into:

1. *Structural genes* contain information about structural proteins, proteins-enzymes, histones and about sequences of nucleotides in various kinds of RNA.

2. *Functional genes* produce effect on the work of structural genes. Genes-modulators and genes-regulators are functional. *Genes-modulators* are inhibitors, intensifiers, modifiers. They enhance, weaken or modify the work of structural genes. *Genes-regulators* and *genes-operators* regulate the work of structural genes.

According to their action genes are subdivided into three groups:

1. *Functioning in all cells* (genes coding enzymes of energy exchange).

2. *Functioning in cells of one tissue* (determining myosine protein synthesis in the muscular tissue).

3. *Specific for one type of cells* (genes of hemoglobin in immature erythrocytes).

3. Transcription regulation in prokaryotes.

Functional regulation of genes in prokaryotes was described in 1961 by A. L'vov, F. Jacob and J. Mono. The unit of transcription regulation in prokaryotes (*operon*) includes a group of structural genes ruled by one gene-operator (fig. 5). A DNA sequence is presumably presented as a straight line, which contains structural-functional parts:

- *promoter* — a site of attachment of the RNA-polymerase;
- *initiator* — a nucleotide sequence, from which transcription starts;
- *gene-operator* — switches on and switches off the work of structural genes;
- *structural genes (A, B, C)* — determine synthesis of proteins-enzymes;
- *terminator* of transcription — disconnects the RNA-polymerase from a DNA.

Structural genes are active not all the time. Some distance from the operon is a *gene-regulator*. It is constantly active. According to its information, the *protein-repressor* is synthesized, it blocks the gene-operator, that is why structural genes are not active and the operon does not work.

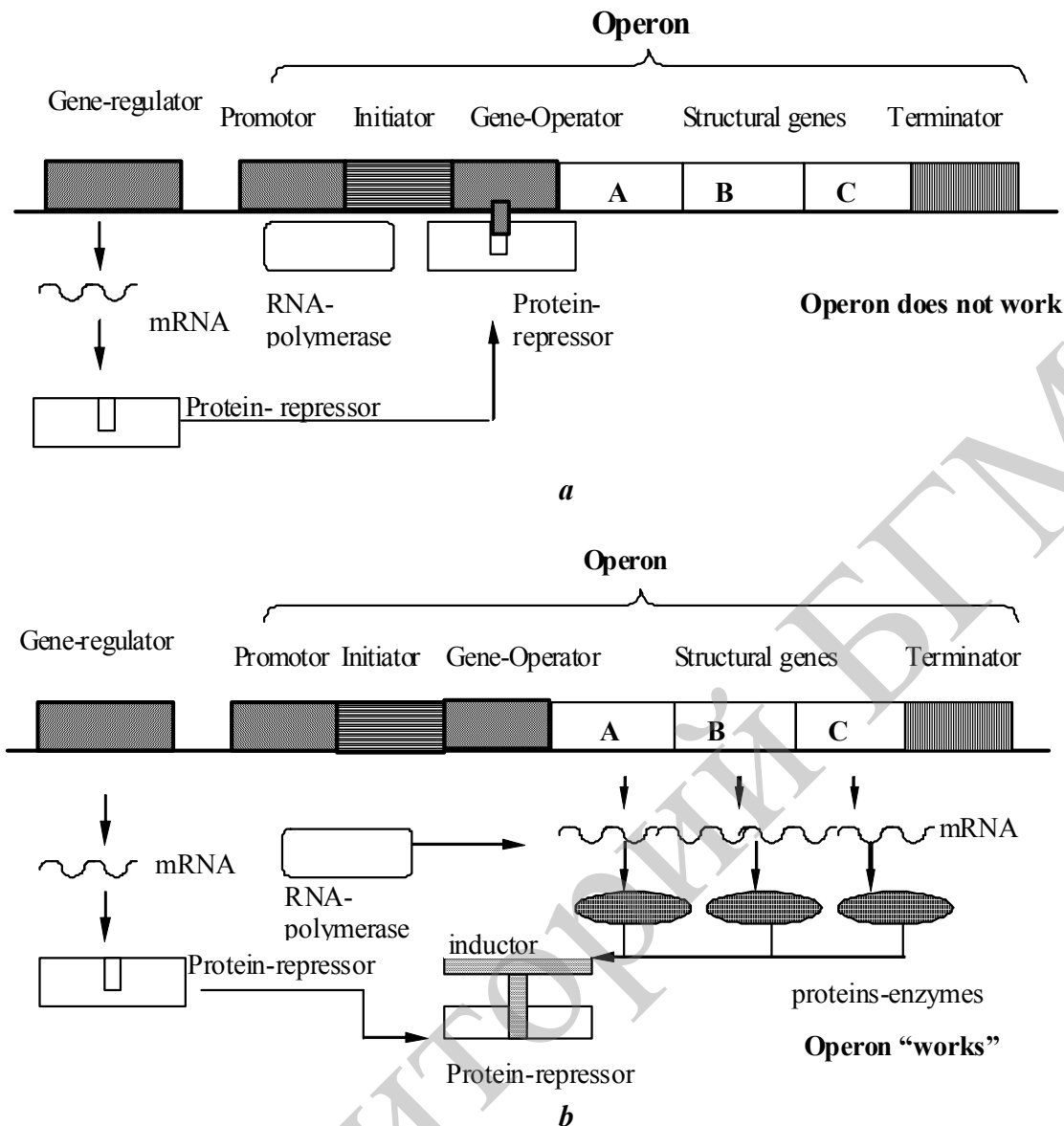

Fig. 5. The diagrams of transcription regulation in prokaryotes

If an inducer (enzymes for its breaking down are encoded in structural genes) comes into the cell, it binds the protein-repressor. The gene-operator is released, RNA-polymerase breaks hydrogen bonds between DNA sequences of structural genes and transcription occurs. An mRNA is synthesized. According to its information proteins-enzymes are synthesized on the cytoplasm ribosomes, they break down the inducer.

The operon works until the whole inducer is not destroyed. After its destruction the protein-repressor is released, which blocks again the gene-operator. Structural genes are switched off, and proteins-enzymes are not synthesized. Each operon has its specific inducer (for example, lactose and fructose).

4. Transcription regulation in eukaryotes (the diagram of G. P. Georgiev).

In 1972 G. P. Georgiev proposed a diagram of genes work regulation in eukaryotes. Principally it does not differ from the diagram of regulation in prokaryotes. But the structure of the diagram itself and the mechanism of its work become more complicated (fig. 6).

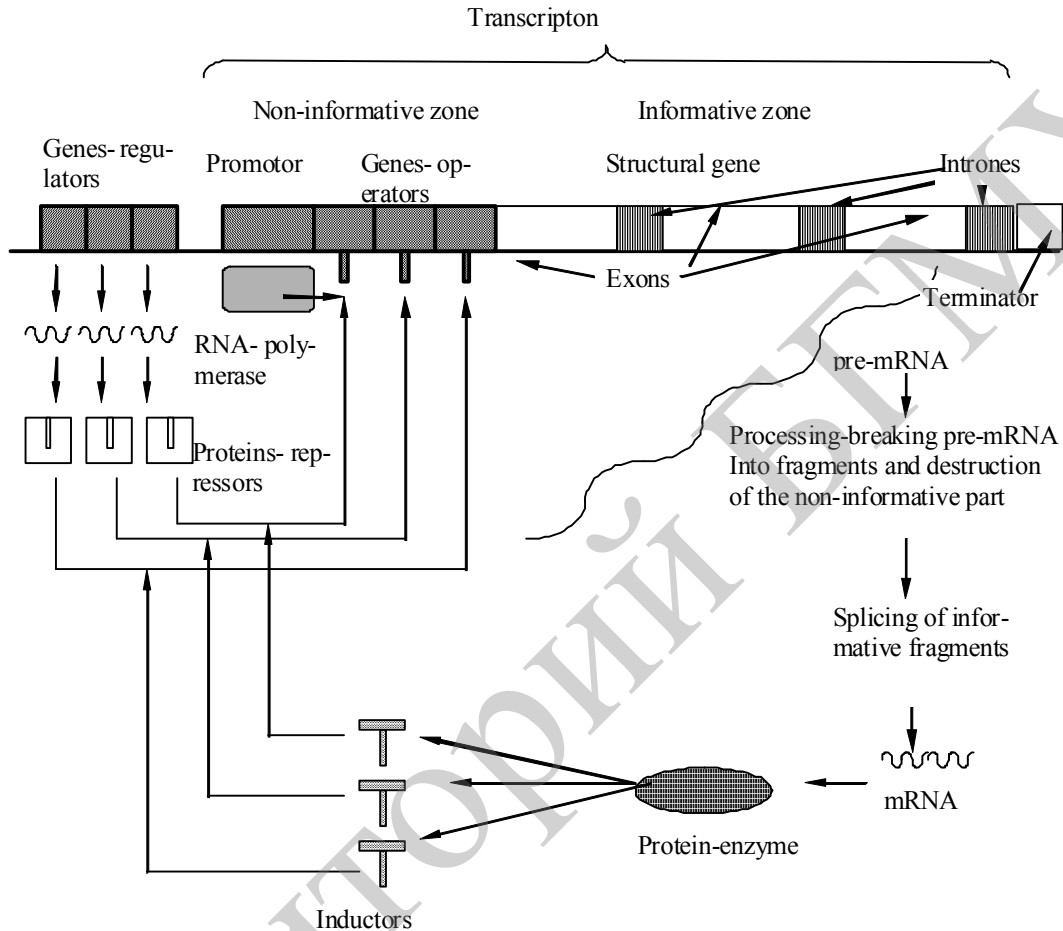

Fig. 6. The diagram of transcription regulation in eukaryots

A transcription unit in eukaryotes is called a *transcripton*. It consists of a non-informative zone and an informative zone. The *non-informative* or *acceptor* zone includes a promoter, initiator and a block of genes-operators. The *informative* zone contains one structural gene having a mosaic structure: it contains *exons* — informative fragments and *introns* — non-informative DNA fragments. The structural gene is followed by a transcription terminator. The *block of genes-regulators* regulates the work of transcriptons. On the basis of their information several proteins-repressors are synthesized, they block genes-operators. Just as in the operon, reading of information from the structural gene occurs, when *inductors* get into the cell. In this case substances with a complex structure serve as inductors (for example, hormones). The inductors release genes-operators from proteins-repressors. An mRNA precursor (*pre-mRNA*) is synthesized, it contains information about the whole sequence of the transcripton, its informative and non-informative parts.

In the nucleus under the action of exo- and endonucleases there occurs the processing of *pre-mRNA* — destruction of the non-informative part and splitting it into fragments corresponding to exons. The mRNA is formed as a result of *splicing* (sewing) of informative parts with *lygases* enzymes. After such transformations mRNA comes into the cytoplasm on ribosomes, where protein encoded in the transcripton is synthesized. After destruction of inductors blocking of genes-operators by proteins-repressors is restored, and the transcripton is switched off.

5. Cytoplasmatic heredity.

The basic genetic information of the organism is contained in the nucleus. Genetic material (*plasmogenes*) contain mitochondria and plastids. There may be a foreign DNA of viruses and bacteria in the cytoplasm.

Criteria of cytoplasmatic heredity:

- inheritance goes on mother's line through the ovum cytoplasm;
- absence of splitting characters in fillies according to Mendel's laws;
- impossibility to reveal linkage groups;
- different results of recurrent crossing (in nuclear inheritance they are identical).

Mitochondrial heredity was described by B. Effrussy in 1949. He discovered that about 1 % of yeast colonies form dwarf colonies. Their growth goes very slowly, because the plasmogens mutation occurred and their mitochondria have no respiratory enzymes. There is information about some human diseases that are due to mutations of mitochondrial genes (mitochondrial cytopathy, non-atresia of upper vertebrae — spina bifida, senility, Leber's disease (atrophy of an optic nerve), anencephaly (absence of the brain), etc.

Plastid heredity (K. Korrens, 1908). The plant Night beauty has molted leaves (green with white spots). There occurred a mutation, and chlorophyll is not produced in some plastids. Plastids are distributed unevenly during multiplication. One part of cells get normal plastids and have green leaves. The other part of cells get plastids without chlorophyll — leaves are white and the plant dies. The third one get plastids both green (normal) and mutated plastids — plants have molted leaves.

Pseudocyttoplasmatic inheritance is associated with getting a viral or bacterial DNA into the cell. Some mice are predisposed to tumors of mammary glands. If normal little mice were fed by a female of a «cancer line», all mice will have tumors of the mammary gland. And vice versa: if little mice of a «cancer line» are fed by a healthy female, all little mice will be healthy. The causative agent of milk in mice was a virus.

Basic terms and concepts:

1. Gene-operator — is a gene that switches on and off the work of structural genes.

2. **Inductor** — is a substance coming into contact with protein-repressor and initiating the operon or transcripton.
3. **Intron** — is a non-informative fragment of structural genes in eukaryotes.
4. **Nucleosome** — is a structural unit of chromatin consisting of 8 proteins-histones and DNA nucleotides.
5. **Operon** — is a transcription unit in prokaryotes.
6. **Promotor** — is a site of attaching a RNA-polymerase.
7. **Processing** — is a fermentative destruction of a pro-mRNA non-informative fragment and splitting the informative part into fragments corresponding to exons.
8. **Repressor** — is protein encoded by the gene-regulator and which is able to block the gene-operator.
9. **Solenoid** — is the second package level of genetic material
10. **Splicing** — is the sum of reactions of combining fragments of pre-mRNA and the formation of mRNA.
11. **Transcripton** — is a transcription unit of eukariotes.
12. **Transposon** — are nucleotides sequences of the DNA molecule with temporary localization.
13. **Exon** — is an informative part of structural genes of eukariotes.

GENETIC ENGINEERING

Purpose of genetic engineering — is designing of genetic structures according to a given plan (creation of organisms with a new genetic program by translocation of genetic information from one organism to the other).

1. Stages of genetic engineering methods:

1. Obtaining genetic material.
2. Translocation of DNA fragments into a molecule-vector.
3. Introduction of a recombinant DNA into a cell-recipient.
4. Selection of cellular clones containing molecules of a hybrid DNA.

2. Obtaining genetic material.

Chemical-fermentative synthesis of genes. Short (8–16 nucleotides) single-sequenced DNA fragments are synthesized *in vitro*, then they are linked with ligases and treated with high temperature for the formation of double-thread DNA molecules. The gene should be **sequenced** for this method.

Fermentative synthesis of complex genes. It is performed by recurrent transcription. An isolated m-RNA is used as a matrix. Using an enzyme revertase, a coding DNA thread is synthesized on it, then it is replicated. The obtained genes do not function in cells as they have no promoter and regulation part. During transfer into a bacterium a promoter is added to structural genes, and the gene starts its work.

Isolating natural genes with restrictases. Restrictases — are enzymes causing DNA hydrolysis with formation of shorter fragments of the molecule. They affect DNA of any organisms if it has sites of recognition (usually they recognize very specific parts for every enzyme with 4–6 pairs of nucleotides in length). These parts are called *palindromes*.

At present there are over 500 restrictases in genetic engineering, they are able to cut the DNA in approximately 120 sites and form double-thread (*obtuse*) ends or single-thread (*sticky*) ends in the DNA.

Gene isolation with restrictases has a number of disadvantages:

- it is not always possible to select restrictases, which allow to cut out a DNA part with a necessary gene;
- the cut out DNA fragment may contain introns, then recombinant DNA will not be able to work in prokaryotic cells due to disability for processing and splicing.

K. Mullis (1987) elaborated a method, which was called a polymerase chain reaction (PCR). PCR is performed in vitro using the enzyme of DNA-polymerase bacteria *Thermus aquaticus*, a complement of 4 nucleotides A, T, G and C and short *primings*. The enzyme is marked by its persistence to high temperature.

Thanks to primings the DNA fragment is limited, it will be copied by DNA polymerase. The PCR has 3 stages:

1. *Denaturation* — a mixture, which contains a specimen of a needed DNA, is heated to 90 °C. Meanwhile, during 15 seconds there occurs breaking of hydrogen bonds between DNA sequences, and two single-sequenced molecules are formed from one double-sequenced molecule.

2. *Hybridization of primings* — the temperature is lowered to +50 °C and primings are added. This stage lasts about 30 seconds.

3. *Polymerization* — the mixture is heated again to +70 °C. At this temperature the Taq-polymerase lengthens both primings from their 3' ends. The primings grow up to the matrix sizes. This process takes 90 sec.

As a result, the number of DNA increases by many times. During 20 cycles the number of DNA copies reaches 10^6 .

3. Incorporation of DNA fragments into the molecule-vector.

Vector — is a small autonomously replicated DNA molecule, which provides multiplication and work of the incorporated definite gene.

Vector molecules should:

- contain points of replication origin and replicate autonomously;
- permanently be inherited by a host cell;
- be contained in a great number of copies in the cell;
- possess a sufficient capacity, which allows cloning big genes in their composition;
- contain «convenient» sites of restriction;

– contain selective markers, which could be used for selecting cells that have received a cloned DNA segment and the marker itself.

The most useful of «vector-host» systems are those, in which the host role play *bacteria E. coli*, and the vector role — **plasmids**.

Plasmids — are ring autonomously replicated DNA molecules that are contained in bacterial cells.

Phage vectors — are phage particles containing a recombinant DNA. Vectors for *E. coli* are constructed on the basis of **phage λ and phage M 13**.

Phage λ contains a double-sequenced DNA of 48 500 pairs of nucleotides in size. It is packed into the head as a linear molecule with sticky ends. After penetration into the cell, sticky ends are mutually paired, the molecule locks into a ring and is sewn by a DNA-lygase. It is possible to clone fragments of 15 000 pairs of nucleotides long in the content of vectors on the basis of phage λ .

Cosmids — are vectors made on the basis of plasmids and phage λ . Cosmids have cos-sites, which are located on both ends of a DNA molecule of phage λ . Complementary single-sequenced parts are 12 nucleotides long, due to which the phage has a linear shape, they join each other through cos-sites and form a long sequence of hundreds of phage DNA or concatamers.

Phasmids — are hybrid vectors that can develop both as a phage and a plasmid. The capacity of plasmids is comparable to that of phage vectors.

4. Introduction of recombinant DNA in the cell-recipient.

The following methods are used:

1. Conjugation — transmission of genetic material in bacteria may occur in direct intercellular contact. Genetic material is transmitted only in one direction.

2. Transformation — transmission of genes with a free soluble DNA (by plasmids), isolated from cells-donors;

3. Transduction — the transmission of DNA from a cell-donor to a cell-recipient may occur with participation of bacteriophages;

4. Transfection — infection with phages λ , $\psi 174$ and T4;

5. Competence — ability of cells to absorb a DNA from the environment;

6. Microinjection of DNA molecules into animal cells;

7. Using liposomes for introducing DNA into animal cells. Liposomes are vesicles surrounded by one or several layers of lipids.

5. Using methods of genetic engineering in medicine.

Southern blott hybridization. The method developed in 1975 allows identifying restriction DNA fragments (fig. 7).

A DNA treated with restrictases is placed on agar jelly in a special chamber for electrophoresis, where an electric field is formed, and under its influence DNA fragments start moving. Short fragments move faster. After electrophoresis a mixture of DNA fragments forms some fractions located some distance from each other. Each such fraction corresponds to one DNA fragment. DNA fragments separated in the agar jelly **are denaturated to single-sequenced mo-**

lecules, and then the whole electrophoretic DNA specter is **printed (blotting)** on an applied to the jelly nitrocellulose **film** and is fixed by high temperature. Then the film is placed into the culture containing a **radioactively marked DNA-probe**. The probe can hybridize only with a specific complementary to it DNA fragment. After interaction with the DNA-probe the film is applied to the nitrocellulose membrane containing all obtained DNA fragments. After exposition there appear lighted spots corresponding to the arrangement of marked DNA fractions on the film (autoradiogram).

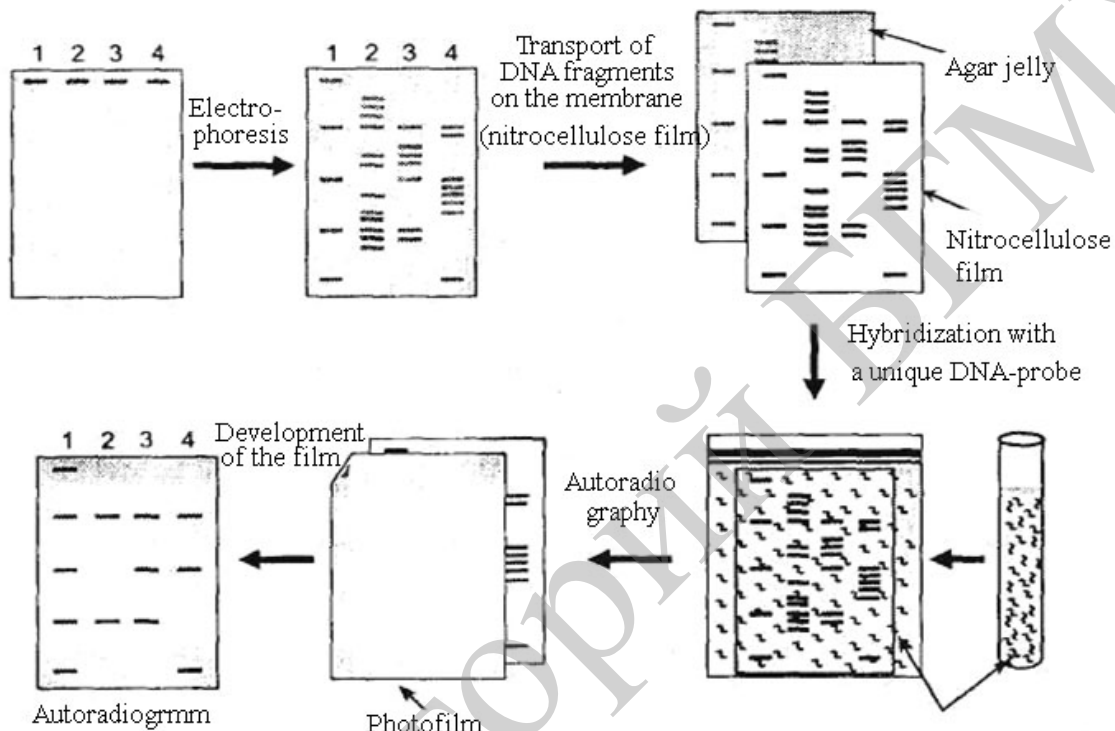

Fig. 7. Southern-blot hybridization method

The method is used for revealing DNA sequences characteristic of mutated genes, it allows diagnosing gene mutations.

Gene dactyloscopy. There is a minisatellite DNA in the human genome, which presents short (9–64 nucleotide pairs), recurrent, tandem, variable DNA sequences. A tandem recurrence — are two or more identical DNA sequences located close to each other. The human has many different tandem DNA recurrences located in different chromosomes, which in total form a unique complement of minisatellite DNA for every human. The method of analyzing these fragments got the name of **gene dactyloscopy (fingerprint of DNA)**.

The technology of gene dactyloscopy: a DNA is isolated from cells and cut into fragments of various length with the help of restrictases. Then the Southern-blot analysis is made. *Fractions containing a minisatellite DNA*, are revealed with a probe, which is complementary to a link from 13 recurrent nucleotides. The probe is radioactive, it lights a roentgen film only in definite

places, giving a picture of some tens of alternating dark fractions corresponding to separate minisatellites.

Basic terms and concepts:

1. Autoradiogram — is a film, where lighted fragments corresponding to the arrangement of marked DNA fractions are revealed.

2. Vector — is a small autonomously replicated DNA molecule, which provides multiplication and the work of a gene incorporated in it.

3. Genic dactyloscopy — is a method analyzing fractions of a minisatellite DNA.

4. Hybridization of primings — is a second stage of the polymerase chain reaction resulting in hybridization of DNA chains with primings.

5. DNA-probe — is a radioactively marked short specific DNA sequence.

6. Cosmids — are artificial constructions made on the basis of plasmids and phage λ .

7. «Sticky ends» — are single-thread complementary DNA ends, which are formed by restrictases.

8. Liposomes — are vesicles surrounded by one or several layers of lipids.

9. Plasmids — are small ring autonomously replicated DNA molecules, which are in bacterial cells.

10. Restrictases — are enzymes causing DNA hydrolysis with the formation of «sticky ends».

11. Restriction sites — are sites recognized by restrictases (there are usually recognized parts of 4–6 pairs of nucleotides in length, strictly specific for every enzyme).

12. Phasmids — are hybrid vectors, which can develop both as a phage and a plasmid.

INHERITANCE REGULARITIES. INTERACTION OF GENES

1. Genetics as a science. Basic concepts of Genetics.

Genetics is a science about laws of heredity and variation. The term «genetics» was introduced into Biology by W. Batson in 1906.

Genotype — is a sum of all genes of the organism.

Phenotype — is a sum of all characters and properties of the organism, which are determined by the genotype and environmental factors.

Alternative signs — are incompatible characters.

Allelic genes — are genes occupying identical loci of homologous chromosomes, they determine the development of one alternative character.

Non-allelic genes — are genes occupying different loci of homologous chromosomes or inhomologous chromosomes, they determine the development of different characters.

Homozygous organism — is an organism, which contains identical genes, form one type of gametes; in crossing with identical individual on the genotype no splitting of characters occurs.

Heterozygous organism — is an organism containing different allelic genes; it forms two types of gametes; in crossing with an identical on genotype individual splitting of characters occurs.

Dominant characters — are characters, which are revealed in a homozygous and heterozygous state.

Recessive characters — are characters, which are revealed only in a homozygous state.

The basic hereditary laws were described by G. Mendel (1822–1884) in his work «Experiments on vegetative hybrids» (1865). G. Mendel used a **hybridological method**. **Hybridization** is crossing of individuals differing on genotype and phenotype, followed by further analysis of fillies (hybrids).

2. Peculiarities of the hybridological method:

1. Crossing of pure lines (homozygotes).
2. Analysis of inheriting separate characters in fillies of some generations.
3. Precise quantitative account of fillies with different characters.

3. Inheritance regularities in monohybrid crossing.

Monohybrid crossing is crossing, when one pair of alternative characters is analyzed.

Law I — is a law of hybrid uniformity: in crossing of homozygous individuals analyzed by one pair of alternative characters one can observe uniformity of hybrids on phenotype and genotype.

P AA	x aa	P (parents)
G (A)	(a)	G (gametes)
F ₁ Aa		F (fillies)

G. Mendel crossed a homozygous plant of pea with yellow seeds and a homozygous plant of pea with green seeds. As a result of such cross G. Mendel obtained plants only with yellow seeds. These plants were heterozygous on genotype.

Law II — is a law of splitting characters: in crossing heterozygous organisms analyzed on one pair of alternative characters one can observe splitting on phenotype in ratio 3:1 and on genotype 1:2:1. **Splitting on phenotype:** 3 parts of individuals with a dominant character, 1 part with a recessive character. **Splitting on genotype:** 1 part of individuals — are dominant homozygotes (AA), 2 parts of individuals — are heterozygotes (Aa), one part of individuals — are recessive homozygotes (aa).

P (F ₁) Aa	x Aa	
G (A)	(a)	(A)
(a)	(A)	(a)
P (F ₁) — hybrids of the 1 st generation are parental		
F ₂ AA,	Aa,	aa

4. Hypothesis of «purity of gametes» and its cytological foundation.

W. Batson proposed a **hypothesis of gametes purity** in 1902 to explain the results of crossing performed by G. Mendel, i. e. genes in hybrids are not hybridized and are in a pure allelic state. The mechanism of meiosis is a cytological basis of Mendel's laws. Homologous chromosomes in meiosis diverge, that is why one gene from an allelic pair gets into a gamete.

5. Analyzing cross. The concept of a phenotypical radical.

Analysing cross — is crossing of an individual having a dominant character, with a recessive zygote for determining its genotype. If in the result of analyzing cross one can observe the uniformity of hybrids, then the initial organism is homozygous (AA); if one observes splitting, then the initial organism is heterozygous (Aa).

Phenotypical radical — is a short record of the genotype made on the basis of the phenotype. Record A-B- means that the phenotype does not depend on what gene will be instead of dash — a dominant or a recessive one: a dominant character will be revealed.

6. Regularities of inheritance in polyhybrid crossing. The law of independent inheritance of characters.

Dihybrid crossing — is crossing, when two pairs of alternative characters are analyzed, if there are more than two pairs — crossing is called **polyhybrid**.

Mendel's law III — is a law of independent inheritance of characters: in crossing homozygous individuals analyzed by several pairs of alternative characters, one can observe independent inheritance of characters and corresponding genes in the second generation.

Gene	Character
A	Yellow color of seeds
a	Green color of seeds
B	Smooth shape of seeds
b	Wrinkled shape of seeds

G	AB	Ab	aB	ab
AB	AABB	AABb	AaBB	AaBb
Ab	AABb	AAbb	AaBb	Aabb
aB	AaBB	AaBb	aaBB	aaBb
ab	AaBb	Aabb	aaBb	aabb

P. **AABB** x **aabb**

G. 

F₁. **AaBb** - 100 %

P. **AaBb** x **AaBb**

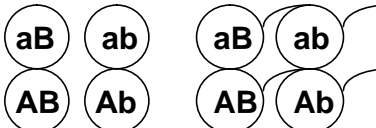
G. 

In dihybrid crossing, when plants differed in two alternative pairs of characters, G. Mendel got the following results:

The Pannet's lattice is used for recording results of dihybrid crossing:

All in all we get 16 combinations: 9 parts A-B-: 3 parts A-bb: 3 parts aaB-: 1 part aabb. If one separately estimates the ratio of characters in pairs 12A-: 4aa-

12B-: 4bb-, we'll get the ratio 3:1 in both cases. On the bases of obtained results one can make a conclusion that in crossing of heterozygous individuals, which are analyzed by several pairs of alternative characters, there will be observed splitting on the phenotype in fillies in the ratio $(3 + 1)^n$, where n — is the number of characters in a heterozygous state.

The significance of Mendel's laws:

1. The laws are universal, they are applicable for all living organisms.
2. G. Mendel introduced a mathematical method into Biology; they are laws of large numbers.

7. Conditions limiting the manifestation of Mendel's laws. Pleotropic action of the gene. Semi-lethal and lethal genes.

Conditions limiting the manifestation of Mendel's laws:

1. Different probability of the formation of gametes and zygotes of various types.
2. Different survival of individuals of different phenotypes (the presence of lethal and semi-lethal genes). *Lethal genes* cause death of organisms before birth or at the moment of birth. *Semi-lethal genes* reduce the life span of the organism.
3. Interaction of genes (except complete domination).
4. Linkage of genes.
5. Cytoplasmatic heredity.

An example of the *action of a lethal gene*. A dominant gene **A** determines a grey color of wool in sheep, and in a homozygous state it produces a lethal action (due to underdevelopment of the stomach in lambs). A recessive gene **a** determines a black color of wool. Instead of an expected ratio 3:1 we get the ratio 2:1 on the phenotype and genotype.

P	Aa	x	Aa	
G	(A) (a)		(A) (a)	
F ₁	AA	Aa	Aa	aa

The pleotropic action of the gene — one gene is responsible for manifestation of several characters. An example, the syndrome of «blue scleras»: a gene causes a blue color of scleras, fragile bones and congenital deafness in humans.

8. Intrallelic interaction of genes.

Intrallelic interactions of genes are interactions of genes from one allelic pair:

1. *Complete domination*: coloration of peas, brown and blue eyes in humans, straight and curly hair and other characters. They are called mendelizing — splitting obeys Mendel's laws.

2. *Incomplete domination* or intermediate inheritance.

Gene A — red flowers.

Gene a — white flowers.

P AA x aa → Aa

Red white pink

3. *Superdomination*: Gene action in a heterozygous state is revealed stronger than in a homozygous one. For example, in Drosophila: a lethal gene is recessive.

sive and homozygotes on this gene die; vitality in heterozygotes is stronger and they are more fertile than homozygous individuals on a dominant gene.

4. *Co-domination*. An example — blood groups on the system AB0: 2 allelic genes (I^A, I^B) are equivalent to each other, but being together in the genotype they cause the appearance of a new character — both show their action (IV blood group).

9. Inheriting blood groups.

Inheriting blood groups in the human by the system AB0 is due to gene I. Alleles of gene I: I^0, I^A, I^B . The presence of gene I^0 does not cause synthesis of anti-genes in erythrocytes (group I).

Genes I^A and I^B are dominant to gene I^0 . Occuring in the genotype in a homo- ($I^A I^A; I^B I^B$) or in a heterozygous ($I^A I^0; I^B I^0$) state they cause synthesis of anti-genes, either A, or B in erythrocytes: A — group II, B — blood group III. If they are in the genotype together, then 2 types of anti-genes are synthesized in erythrocytes: A and B — blood group IV(AB).

Multiple alleles — are alleles that are presented in the population by more than 2 states (alleles of the gene I — I^0, I^A, I^B).

Inheriting Rh-factor. The presence of protein, Rhesus-factor, in erythrocytes is due to Gene D.

The blood of such people is Rh-positive (Ph^+). When the Rhesus-factor (d) is absent, the blood is Rhesus-negative (Rh^-).

Inheriting blood groups on system MN. This system is due to the presence of two alleles — L^N and L^M . Gene L^M causes the presence of anti-gene M in human erythrocytes (blood group M), and gene L^N — of anti-gene N (blood group N).

The simultaneous presence of both alleles in the genotype causes the presence of both anti-genes M and N in erythrocytes (blood group MN).

10. Interallelic interaction of genes.

Interallelic interaction — is the interaction of non-allelic genes.

1. **Complementarity** — is interaction, when a gene of one allele complements the action of a gene of the other allele. Coloration of flowers in fragrant peas is determined by a combination of dominant genes of allele A and allele B. The absence of one or two dominant genes in the genotype determines the formation of white flowers.

Colored flowers: A – B –; white flowers: A-BB, aaB-, aabb

P AaBb x AaBb

Red flowers Red flowers

G $\begin{pmatrix} AB \\ Ab \end{pmatrix}$ $\begin{pmatrix} AB \\ Ab \end{pmatrix}$

$\begin{pmatrix} aB \\ ab \end{pmatrix}$ $\begin{pmatrix} aB \\ ab \end{pmatrix}$

F₁ 9A-B-; 3A-bb; 3aaB-; 1aabb

Red White White White

(according to Mendel's law a ratio 9:3:3:1, splitting obtained according to phenotype is 9:7).

2. **Epistasis** — is interaction, when a dominant (recessive) gene of one allele suppresses the manifestation of gene action of the other allele. A suppressing gene is called *epistatic* (inhibitor or suppressor); a suppressed gene is called *hypostatic*. An example of epistasis — coloration of feathering in hens. Feather coloration is determined by gene **C**; a dominant gene of allele **I** suppresses its action.

Genotype of hens with colored feathering C – ii

Genotype of hens with white feathering C-I-, cc-I-, ccii

P CcIi x CcIi

White hens White hens

F₁ 9C-I-: 3C-ii: 3ccI-: 1ccii

White colored white white (splitting by Mendel is 9:3:3:1,

Splitting obtained according to phenotype is: 13 white: 3 colored)

3. **Polymeria** — several non-allelic genes enhance the phenotypic manifestation of the character.

In this way some human quantitative characters are inherited: body mass, height, skin pigmentation, blood pressure. Polymeric genes are usually denoted by identical letters but with different figure indices.

For example, skin pigmentation in the human: negroids — P₁P₁P₂P₂P₃P₃; europeoids — p₁p₁p₂p₂p₃p₃; mulates — P₁p₁P₂p₂P₃p₃. The more dominant genes are in the phenotype, the stronger is the character expressed.

Basic terms and concepts:

1. **Allelic genes** — are genes occupying identical loci of homologous chromosomes, they determine the development of different states of one character.

2. **Genome** — is a sum of all genes in a haploid complement of chromosomes.

3. **Genotype** — is a sum of all genes in the organism.

4. **Homozygous organism** — is an organism containing identical variants of one allele in somatic cells (AA, aa).

5. **Complementarity** — is interallelic interaction, when a gene of one allele complements the action of a gene of the other allele.

6. **Multiple allelism** — is a phenomenon, when a gene in the population is presented by more than two allelic states.

7. **Polygenic inheritance** — is inheritance of characters that are determined by polymeric genes.

8. **Superdomination** — is interaction of genes, when a dominant gene in a heterozygous state shows its action stronger than in a homozygous one.

9. **Phenotypical radical** — a short record of the genotype on the basis of the phenotype.

10. **Phenotype** — is a sum of characters and properties of the organism.

LINKAGE OF GENES

1. Experiments of T. Morgan. Complete and incomplete linkage.

In 1911–1912 experiments on *Drosophila* were performed in the laboratories of T. Morgan. It is convenient for genetic investigations, because:

- it has few chromosomes (4 pairs),
- early sex maturity, fast change of generations,
- a great number of fillies, it is easy to make similar conditions for *Drosophila*.

Two pairs of alternative characters were analyzed in *Drosophila* on crossing.

Gene B — a grey body	Gene V — normal wings
Gene b — a black body	gene v — short wings

The 1st cross of flies was done according to Mendel's scheme:

P BBVV x bbvv

F₁ BbVv — grey with normal wings — 100 %

To clear out the genotype of hybrids an analyzing cross of a male of the 1st generation was performed. It is crossing of an individual with dominant characters with a recessive homozygote.

According to Mendel's law III T. Morgan expected to get an equal quantity of flies in the fillies of each phenotype — per 25 %. However he got flies of two phenotypes (per 50 %) with parental characters. T. Morgan proposed that genes of the body color and wings length are localized in one chromosome and passed together, i. e. linked. **Linkage of genes** — is a joint transmission of genes of one chromosomal pair.

A male *Drosophila* has a **complete linkage of genes**. One of a pair of homologous chromosomes contains 2 dominant genes (**BV**), and the other — 2 recessive (**bv**). In the process of meiosis one chromosome (with genes **BV**) gets into one gamete, and the other (with genes **bv**) in the other. Thus, there form not 4 but 2 types of gametes in a diheterozygous organism. Fillies also have such characters as their parents.

In the 3rd experiment T. Morgan crossed a hybrid female of *Drosophila* with a recessive male. He got 4 types of fillies: 2 types (83 %) with parental characters and 2 types (17 %) with a new combination of characters. Individuals composing per 8,5 % formed in the process of crossing-over and are called *crossoverous*. The total number of crossoverous individuals comprises 17 %, which corresponds to the distance between genes of the body color and wing length — 17 morganids.

II P(F ₁) bbvv x B-V-	III P(F ₁) B-V- x bbvv
F ₂ bbvv B-V-	F ₂ B-V- bbV- B-vv bbvv
50 % 50 %	41,5 %; 8,5 %; 8,5 %; 41,5 %

In a female *Drosophila*, unlike a male, crossing-over impairs linkage of genes and stimulates recombination of genetic material.

Linkage is called *complete* if crossoverous individuals are not formed (a male of *Drosophila*). If they are formed (a female of *Drosophila*), linkage will be *incomplete*.

2. Autosomal and gonosomal linkage groups.

Genes localized in one chromosome (a pair of homologous chromosomes) are transmitted together and compose a *linkage group*. The number of linkage groups is equal to the *haploid number of chromosomes*. Linkage can be *autosomal* (the groups linking chromosomes) and *gonosomal* (the groups linking sex chromosomes) There are 23 linkage groups in the human: 22 *autosomal* and 1 *gonosomal* group.

3. Crossing-over, crossoverous and non-crossoverous gametes.

Linkage of genes is disturbed by a biological phenomenon — *crossing-over*, which occurs in the prophase of meiosis I. Crossing-over is the formation of a cross and exchange of identical parts of chromatids of homologous chromosomes in a bivalent. It does not occur in a *Drosophila* male and a *bombyx* female. Crossoverous gametes — are gametes containing chromatids that have undergone crossing-over. Unmodified chromatids are included into *non-crossoverous gametes*. Crossing-over occurs not always, that is why there are always less crossoverous individuals than non-crossoverous. The linkage force between genes (frequency of crossing-over) depends on the distance between them: the more is the distance, the weaker are linkage forces, the more frequently crossing-over occurs.

4. Basic issues of the hereditary chromosomal theory.

1. Genes are arranged in chromosomes in a linear order in definite loci. Allelic genes are in identical loci of homologous chromosomes.

2. All genes of one chromosome compose a linkage group and are inherited together. The number of linkage groups is equal to the number of pairs of homologous chromosomes.

3. Crossing-over (exchange of allelic genes) is possible between homologous chromosomes.

4. The percentage of crossing-over depends on the distance between genes in the chromosome. 1 % of crossing-over is equal to 1 morganid — a unit of the distance between genes called to honor T. Morgan.

5. Maps of eukariotic chromosomes (genetic and cytological).

Knowing the distance between chromosomes one can make their maps.

A genetic map: the chromosome is presented as a straight line, along which genes are presumably located according to the results of crossing being analyzed.

A cytological map — is a precise picture or a photo of the chromosome. The arrangement order of genes is determined during comparison of analyzing cross results and chromosomal reconstructions.

Basic terms and concepts:

1. **Crossoverous gametes** — are gametes, into which chromatids exposed to crossing-over got.
2. **Non-crossoverous gametes** — are gametes, into which chromatids not exposed to crossing-over got.
3. **Genetic map of the chromosome** — is a part of a straight line, where the order of genes arrangement is marked.
4. **A cytological map of the chromosome** — is a photo or a picture of the chromosome, on which the order of genes arrangement is marked.
5. **Recombinants** — are organisms that are formed during the fusion of crossoverous gametes.
6. **Linkage of genes** — is a joint transmission of genes of one chromosome.

VARIATION

1. Variation and its types.

Variation — is a property of living organisms to obtain characters distinguishing them from their parents in the process of ontogenesis (fig. 8).

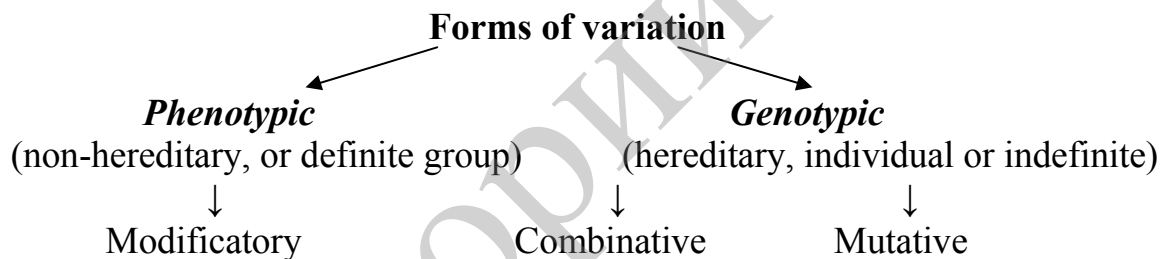

Fig. 8. Forms of variation

2. Phenotypical variation. The reaction range.

A phenotypical or modificatory variation — is modification of the phenotype without changing the structure of the genotype. That is why it is *non-hereditary*. Modifications occur under the action of environmental factors, changes can be predicted for a *whole group of individuals*. As a rule, modifications have an *adaptive character* — enhancing of skin pigmentation (sun-tan) under ultra-violet radiation.

The *reaction range* determines the limits of modificatory variation. It is controlled by the genotype and is inherited. If the character has a narrow reaction range, it changes insignificantly (fatness of milk). The character with a broad reaction range changes in wide limits (body mass).

3. Genotypical variation and its forms.

A **genotypical variation** — is modification of the phenotype due to changing the genotype. It is inherited. It includes a *combinative* and *mutational* variation.

A combinative variation is associated with recombination of parental genes in fillies without changing the structure of genetic material. For example, appearance of a blue-eyed child in heterozygous brown-eyed parents.

Mechanisms of combinative variation:

1. Free combination of chromosomes and chromatids, when they diverge in meiosis.
2. Crossing-over in meiosis (recombination of genes).
3. Incidental meeting of gametes of different types during fertilization.

Mutational variation or mutations — is a sudden uneven changing of genetic material under the influence of environmental factors. It is inherited.

Differentiation of mutations from modifications (fig. 9).

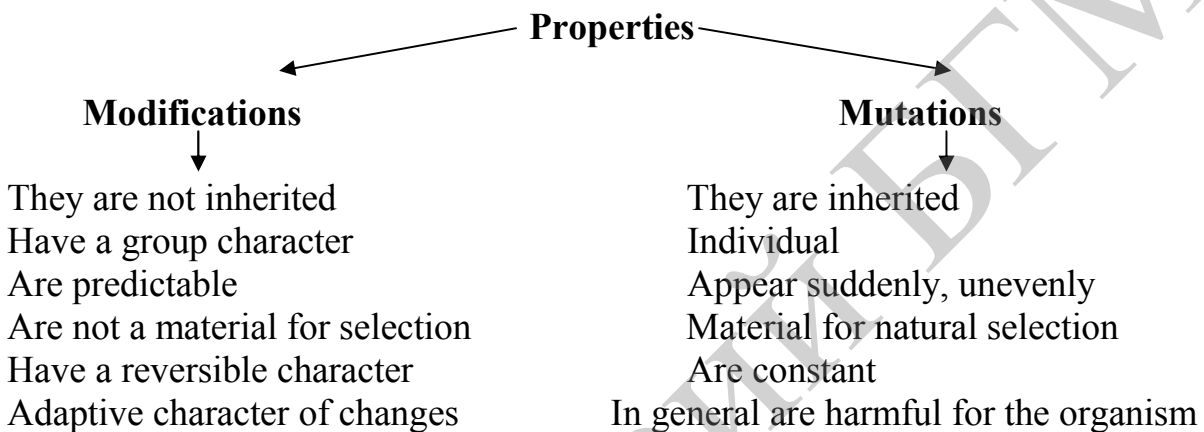

Fig. 9. Differentiation of mutations from modifications

4. Mutagenic factors.

Mutagenic factors — are factors causing mutations. Mutagenic factors are divided into physical, chemical and biological

Physical mutagens — are various kinds of radiation, temperature, humidity, etc.

They cause impairments of the structure of genes and chromosomes; formation of free radicals interacting with DNA; cuts of the division spindle threads; formation of dimers of adjacent pyrimidine bases of one DNA sequence (T-T), etc.

Chemical mutagens — some medicines, formalin, yperite, colchicin, food conservants, etc.

They cause desamination and alkylation of DNA molecule nucleotides; replacement of nitrogenous bases for their analogues (substances with similar structure); suppress synthesis of precursors of nucleic acids (nucleotides, ribose, deoxiribose).

Biological mutagens — are viruses, bacteria, metabolites — protists and helminthes.

They cause impairments of DNA synthesis, divergence of chromosomes and chromatids in the anaphase of meiosis and mitosis; waste products of para-

sites act as chemical mutagens, destroy chromosomal telomeres and impair the process of crossing-over.

5. Classification of mutations.

The formation process of mutations is called *mutagenesis*.

According to etiological factors:

1. Spontaneous — appear under the influence of natural factors (mutagens) without participation of the human.
2. Induced — the result of directed effect of definite mutagenic factors.

According to mutated cells:

1. Gametic — occur in sex cells and are transmitted during sexual reproduction.
2. Somatic — occur in somatic cells, show in the individual itself and are inherited only in vegetative reproduction.

According to the outcome for the organism:

1. Negative: lethal, incompatible with life and semi-lethal, reducing vitality.
2. Neutral, affecting the vitality inconsiderably.
3. Positive, increasing the vitality.

According to modification of the phenotype:

1. Morphological (small eyes, 6 fingers on the hand).
2. Biochemical (albinism, hemophylia).

According to modification of the genotype:

1. Genomic.
2. Chromosomal.
3. Genic.

6. Genomic, chromosomal and genic mutations.

Genomic mutations — is changing of the number of chromosomes. **Haploidy** — is a chromosomal complement $1n$. It occurs in drones (males) in bees. The vitality of such organisms is decreased, as all recessive genes are revealed in them. *Polyploidy* — increase of a haploid chromosomal complement ($3n$, $4n$, $5n$). Polyploidy is used in plant growing. It increases fruitfulness. For the human haploidy and polyploidy are lethal mutations.

Heteroploidy — is a change of the number of chromosomes indivisible by a haploid one ($2n \pm 1$, $2n \pm 2$ and so on). *Trisomy*: an X-chromosome is added to a pair of sex chromosomes of a female organism, the trisomy syndrome develops (47 , XXX); if it is added to sex chromosomes of a male organism, the Klinefelter's syndrome develops (47 , XXY). *Monosomy*: absence of one chromosome in the pair — 45 , X0 — syndrome of Shereshevsky-Terner. *Nullisomy*: absence of a pair of homologous chromosomes (for humans, it is a lethal mutation).

Chromosomal mutations (or chromosomal aberrations) — are modifications of the structure of chromosomes (interchromosomal or intrachromosomal).

Rearrangements **inside one chromosome**: inversions, lacking (deficiency and deletion), duplications. *Deletion* is lacking of a middle part of the chromosome; *deficiency* — of a terminal end; *duplication* — doubling of a chromosomal part; *inversion* — changing of the genes arrangement order in the chromosome. In deletion of telomere parts of both arms of chromosomes one can observe locking of the remaining structure into a ring and forming of *ring chromosomes*.

Interchromosomal mutations are translocations. Translocations can be: *reciprocal* — 2 chromosomes exchange with their parts; *non-reciprocal* — parts of one chromosome are relocated on the other; *Robertson's* — 2 acrocentric chromosomes are linked with their centromeres.

Lacking and duplications are always revealed phenotypically, because a complement of genes changes. Phenotypical inversions and translocations are not always revealed. In these cases conjugation of homologous chromosomes becomes difficult and the distribution of genetic material between daughter cells is impaired.

Genic mutations (point or transgenations). They are associated with changes of the structure of genes and cause the development of metabolic diseases.

Mutations of structural genes:

1. *Bias of the reading frame* — deletion or insertion of one or several pairs of nucleotides into a DNA molecule.

2. *Transition* — is a mutation, when there occurs a replacement of a purine base for a purine or pyrimidine one for another pyrimidine ($A \leftrightarrow G$ or $C \leftrightarrow T$). Such replacement results in changing codons.

3. *Transversion* — replacement of a purine base for a pyrimidine or a pyrimidine for a purine base ($A \leftrightarrow C$; $G \leftrightarrow T$) results in changing codons. Changing of structural genes results in *missense-mutations* (changing of the codons meaning). If senseless codons are formed (UAA, UAG, UGA), they cause *non-sense-mutations*. These codons do not determine amino acids but are terminators — they determine the end of information reading.

Mutations of functional genes:

1. The protein-repressor is modified and it does not suit the gene-operator. In this case structural genes are not switched off and work permanently.

2. The protein-repressor is tightly joined with the gene-operator and is not released by the inductor. Structural genes do not work permanently.

3. The impairment of alternation of the processes of repression and induction. If the inductor is absent, a specific protein is synthesized, in the presence of the inductor it is not synthesized. Such impairments of transcription actions are observed in mutations of a gene-regulator or a gene-operator.

In the majority of cases genic mutations are revealed phenotypically.

7. Stability and repair of genetic material, anti-mutagens.

Anti-mutagenesis is the impact on the cell or organism, which blocks or reduces the probability of mutations occurrence. Stability of genetic material provides anti-mutagenic mechanisms.

1. **Natural barriers:** a diploid complement of chromosomes (parity of chromosomes), double DNA spiral, redundancy (degeneration) of the genetic code, iteration of some genes.

2. **Repair of the DNA structure** — is an intercellular process of an impaired DNA molecule restoration.

In 1962 K. Rupert described photoreactivation or light repair. He established that when phages, bacteria and protists are radiated by ultra-violet radiation, their vitality drops. But if they are exposed to visible light, their vitality restores. Under the action of ultraviolet radiation dimers are formed in a DNA molecule (chemical bonds between bases T-T of one sequence). This inhibits reading of information. Visible light activates enzymes, which destroy links of dimers.

The most common is a **dark** or *excision* repair (A. Herren) Four groups of enzymes take part in it:

a) *endonuclease* «recognizes» an impaired part and cuts a DNA thread next to it;

b) *exonuclease* removes the impaired part;

c) *DNA polymerase* synthesizes a DNA fragment instead of a destroyed one according to a complementarity principle;

d) *lygase* links the ends of an inserted part with the main DNA thread.

The impairment of the repair process may result in the development of diseases such as *pigmental xeroderma* and *Fankoni's anemia*.

3. **The presence of anti-mutagens.** These are substances of various origin, that in small concentrations are able to stabilize a mutation process; biologically active compounds — histamine and serotonin, anti-oxidants, sulphanilamide preparations, fresh vegetable juices, α -tocopherol, which decreases the number of both genic and chromosomal mutations).

8. Biological bases of cancerogenesis

Cancerogenesis is a process of formation and development of tumors.

1. *Mutational conception* — in the basis of cancerogenesis are genomic or chromosomal mutations of somatic cells (G. de Freeze, 1901).

2. *Viral-genetic conception* — viruses are causative agents of malignant growth. Mutagens and cancerogens stimulate the activity of viruses; their genome is included into the cellular DNA and changes its properties (L. A. Zilber, 1945).

3. *Epigenomic conception* — in the basis of transformation of a normal cell into a tumor are persistent impairments of the structure of functional genes (Yu. M. Olenev, 1967, and A. Yu. Bronovitsky, 1972).

4. *Oncogen conception*. Cellular DNA contains definite parts — *protooncogens*. They can be received from parents or introduced into the cell by a virus. Protooncogens are activated in mutations or when a viral promoter gets into the cell. They pass into an active form — oncogens, the cell transforms into a tumor (R. Hubner, 1969.; G. I. Abelev, 1975).

Basic terms and concepts:

1. **Deletions** — intrachromosomal mutations associated with a loss of a middle part of the chromosome.

2. **Duplications** — intrachromosomal mutations associated with doubling of a part of the chromosome.

3. **Inversion** — intrachromosomal mutations, when the gene arrangement order impairment occurs.

4. **Cancerogenesis** — a process of formation of tumor cells.

5. **Ring chromosomes** — chromosomes, which are formed during deletion of telomere parts and locking of the structure into a ring.

6. **Reaction range** — limits of modificatory variation.

7. **«Bias of the reading frame»** — a mutation variety of structural genes, when an insertion or deletion of nucleotides occurs.

8. **Transitions** — a mutation variety of structural genes, when a replacement of bases occurs: A for G or T for C.

9. **Transgenations** — genomic mutations.

10. **Translocations** — exchange of inhomologous chromosomes parts.

BIOLOGY AND GENETICS OF SEX

1. Sex as a biological character. Sexual characters.

Sex is a complex of morphological, physiological, biochemical and behavioral characters of the organism that provide the process of reproducing their own selves and transmission of genetic information from generation to generation.

Primary sexual characters — external and internal sex organs. They take a direct part in the process of reproduction, are germinated in the embryogenesis and are formed by the moment of birth.

Secondary sexual characters appear in the period of puberty. They include peculiarities of the bony-muscular system, distribution of the adipose tissue and hair covering, voice timbre, peculiarities of the nervous system and behavior and other characters.

2. Characters controlled and limited by sex.

Genes determining characters limited by sex are located in autosomes of individuals of both sexes, but are revealed only in individuals of one sex (a gene of lactation is revealed in females of the cattle; a gout gene is revealed only in men).

Genes determining characters *controlled by sex* are also in autosomes of individuals of both sexes, but the degree and frequency of their manifestation is different (an alopecia gene is differently revealed in men and women).

3. Characters linked with an X-chromosome and holandric ones.

Characters *linked with sex chromosomes* are divided into characters linked with an X-chromosome and holandric. Genes located in an X-chromosome non-homologous part determine characters *linked with an X-chromosome (linked with sex)*. They are about 200 (hemophilia, daltonism). They are inherited from father only to daughter and from mother both to son and daughter.

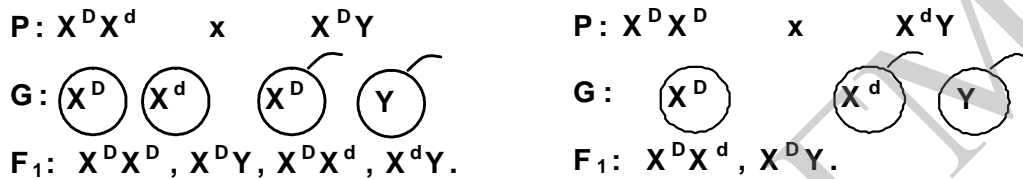

Genes located in a Y-chromosome non-homologous part determine holandric characters; 6 of them are described (ichthyosis, membranes between toes) they are inherited from males and are revealed only in men.

4. Chromosomal sex theory.

The sex in majority of animals is determined at the moment of fertilization by a combination of sex chromosomes (heterochromosomes) — X and Y.

XX is a female *homogametic sex*, it forms one type of gametes; XY — is a male *heterogametic sex*, it forms two types of gametes. In this way sex of humans and animals is determined. Birds, fish, butterflies have a homogametic male sex and a heterogametic female sex. Grasshoppers and locust have a female sex XX, a male sex X0.

This theory of determination sex got the name of *chromosomal theory*. It was proposed in 1907 by K. Korrens.

5. Peculiarities of sex determination in humans and its impairments.

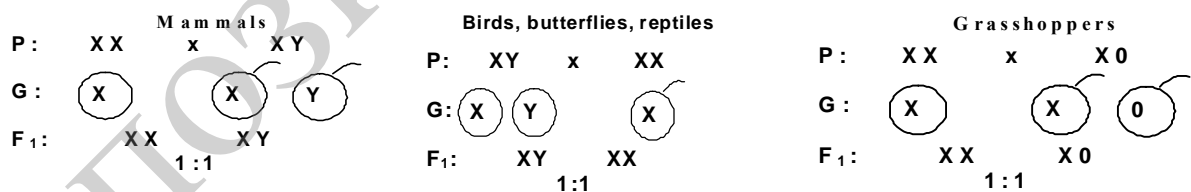

In the human the *germ formation* of gonads, internal and external sex organs occurs till the 4th week of embryogenesis. On the initial stage it is provided by one X-chromosome. The primary gametes in humans can be revealed on the 3rd week of the embryonic development in the ectoderm of the yolk sac.

Differentiation of germs into sex glands and sex organs in an embryo and fetus occurs from the 4th to 12th weeks of intrauterine development; at this stage it completely depends on the second sex chromosome. If it is an X-chromosome, primary sex cells develop into ovogonies and the whole sex system develops according to a female type. The development of primary sex germs according to

a male type is determined by the presence of a Y-chromosome in the complement. Primary sex cells are differentiated in spermatogonies, forming testicles and external sex organs.

Physical sex determinants: genetic sex, gonad sex, gamete sex, hormone sex and morphological sex. *Physical (morphophysiological) determinants of sex* are common for humans and the majority of animals. **An Intermediate determinant:** civil sex. **Social-psychological determinants:** sex of bringing up, sex of self-consciousness, sex role, choice of a sexual partner. *Social-psychological determinants* have a great significance in the formation of sex consciousness and ideas about sex role in the human. A choice of a sexual partner depends on them. In the majority of cases it is an opposite sex (*heterosexualism*), sometimes — *homosexualism* (identical sex).

Transsexualism is a persistent discrepancy of sexual self-consciousness and its true genetic and gonad sex and a wish to change one's sex.

Transvestism is sexual perversion when the excitement and satisfaction are reached during putting on clothes of the opposite sex. In humans a *Morris's syndrome* may occur. It is manifestation of a female phenotype in genotype XY (*testicular feminization*). Male sex hormones are excreted after germination of testes, but in embryos no protein-receptor making cells sensitive to these hormones is formed. The development according to a male type stops and a female phenotype develops.

6. Sexual chromatin.

In 1949 M. Barr and Ch. Bertram revealed in nuclei of cat's nerve cells a large *lump of chromatin*. It was revealed only in females and was absent in males. Later it was established, that it was an inactivated X-chromosome. This lump was called sex chromatin or a *Barr body*. The Barr body can be attached to a nuclear membrane, it may be freely located in the karyoplasm or present a nuclear process in nuclei of blood cells («drum sticks» in neutrophils).

7. Chromosomal sex diseases.

When divergence of sex chromosomes in the process of meiosis is impaired,

♀ \ ♂	X	XX	0
X	XX	XXX	X0
Y	XY	XXY	Y0
XY	XXY	XXXY	XY*
0	X0	XX*	0

the human may develop chromosomal diseases of sex:

1. XX and XY — a normal male and female organism.

2. XX* — a normal female organism that got both sex chromosomes from mother.

3. XY* — a normal male organism that got both sex chromosomes from father.

4. Y0, 0 — an organism lacking vital capacity.

5. XXX — an X-trisomy syndrome. Karyotype — 47, XXX. A female phenotype. Incidence frequency 1:800–1:1000. Nuclei of somatic cells have two

Barr bodies. Tall height. The constitution corresponds to a male type. In 75 % of cases mental retardation is marked. Secondary and primary sex characters are underdeveloped, the ovaries function is impaired. Sometimes they may have children.

6. X0 — Shereshevsky-Terner's syndrome. Karyotype — 45, X0. Female phenotype. Incidence frequency 1:2000–1:3000. Nuclei of somatic cells have no Barr body. A height of an adult is 135–145 cm. Specific characters: a short neck; a skin fold from the occiput to the shoulders, a low position of ear flaps, a low growth of hair at the occiput, changed joints of fingers and toes; 15 % have congenital defects of the heart and renal function anomalies. Ovaries and secondary sex characters are underdeveloped. Such patients are sterile. The intellect does not suffer in this syndrome. Treatment: early hormonotherapy.

7. XXY, XXXY — Klinefelter's syndrome. Karyotype — 47, XXY, 48, XXXY. A male phenotype. Incidence frequency 1:400–1:500. Nuclei of somatic cells contain one or two Barr bodies. Tall height. Female type of constitution. Gynecomastia — mammary glands are enlarged. Hair covering is poorly developed, testes are underdeveloped, the process of spermatogenesis is impaired (individuals are sterile), but sex reflexes are retained. The intellect is decreased. The more are X-chromosomes in the genotype, the stronger suffers the intellect.

8. Primary, secondary and tertiary ratios of sexes.

In theory, the sex ratio at the moment of fertilization is approximately 1:1. A real ratio of sexes differs from a theoretical one.

The *primary* sex ratio at the moment of conception is 140–150 male zygotes per every 100 female zygotes.

The *secondary* sex ratio (at the moment of birth) is ♀:♂ = 100:106. Such ratio can be explained by a greater vitality of female zygotes, homozygoteness of male zygotes (all recessive genes located on a non-homologous part of an X-chromosome, are revealed) and alienation (on proteins) for the mother's organism of a male zygote.

The *tertiary* ratio (a postnatal period): by 20 years the ratio is ♀:♂ = 100:100; by 50 years — 100:85; by 80 years — 100:50. This ratio can also be explained by a greater vitality of a female organism and a greater mortality of men in the postnatal period (diseases, wars, hard physical labor, harmful habits, car crashes).

Basic terms and concepts:

1. Hermafrodism — the presence of sex characters of both sexes in one organism.

2. Holandric characters — characters determined by genes located on a non-homologous part of a Y-chromosome.

3. Characters controlled by sex — characters that appear with various frequency and degree in individuals of different sex.

4. Characters limited by sex — characters that appear only in individuals of one sex.

5. Characters linked with an X-chromosome — characters determined by genes located on a non-homologous part of an X-chromosome.

6. Klinefelter's syndrome — a chromosomal disease due to the presence of an additional X-chromosome in a male organism,

7. Morris syndrome — formation of a female phenotype in XY genotype.

8. X-trisomy syndrome — a chromosomal disease in women, when an additional X-chromosome is present.

9. Shershevsky-Terner's syndrome — a chromosomal disease in women, when one X-chromosome is absent.

10. Transsexualism — a persistent discordance of sexual self-consciousness in the human to his genetic and gonad sex (sensation of belonging to an opposite sex).

11. Physical sex determinants — morphophysiological determinants.

BASES OF HUMAN GENETICS

CLASSES I

1. Present tasks of human genetics.

Human genetics studies regularities of inheriting normal and pathologic characters, their modification under the influence of the environment. The section of **medical genetics** studies mechanisms of hereditary pathology, develops methods of diagnosis, treatment and prophylaxis of hereditary human diseases.

The tasks of medical genetics are:

1. Improvement of early diagnostic methods of hereditary diseases.
2. Wide usage of medico-genetic consulting.
3. Setting up a gene pool, development of genic therapeutic methods on the basis of genetic engineering.
4. Development of methods protecting the human gene pool.

2. The human as an object of genetic investigations.

The human as an object of genetic investigations has its peculiarities and a number of difficulties.

Peculiarities of human genetics:

- 1) impossibility to apply a hybridological analysis and experimentation on humans;
- 2) a complex karyotype — many chromosomes and linkage groups;
- 3) late sexual maturity, a small number of fillies in the family, slow change of generations;
- 4) a great variety of ecological and social conditions; impossibility to create identical living conditions.

Advantages of the human as a genetic object:

- 1) a great number of individuals in populations, the possibility of analyzing characters on vast material;
- 2) international co-operation of geneticists;
- 3) the human is better clinically studied than other objects;
- 4) development of special methods for overcoming difficulties during studying human genetics.

3. Clinical-genealogical methods.

A genealogic analysis was proposed by F. Halton in 1883. The **clinical-genealogical method** was developed on its basis; it is making up genealogies and analyzing the transmission mechanism of a character in a number of generations.

The method allows determining:

- a relation degree of people in one family;
- if the character is hereditary; the type of inheritance; zygosity of the members of genealogy (homozygotes or heterozygotes);
- penetration of a gene (frequency of its appearance);
- probability of revealing the character in fillies (genetic risk).

Conditional designations used in making up a genealogy, are given in fig. 10.

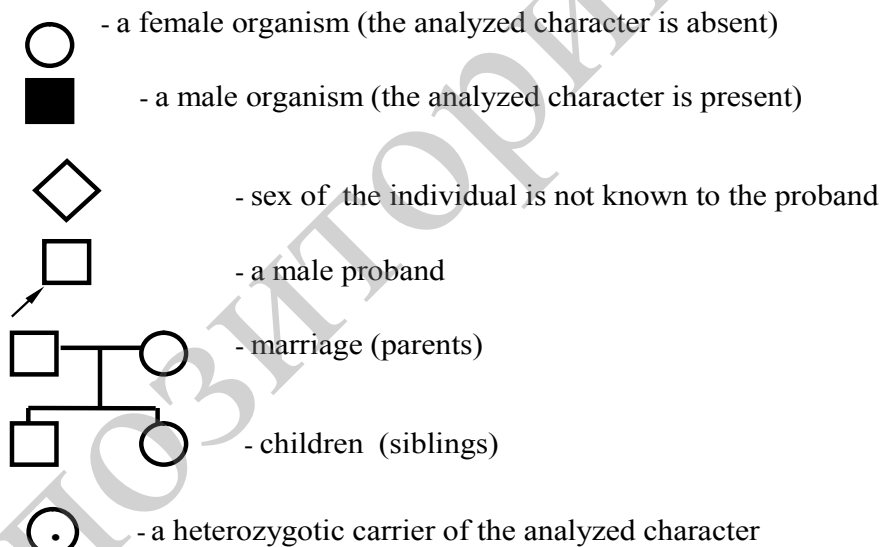

Fig. 10. Conditional designations used in a genealogy

A human, from whom a genealogy starts, is a proband and is marked with an arrow.

Genealogic analysis stages:

- taking information about relatives of the proband;
- making up a genealogy;
- analyzing the genealogy and conclusions.

Types of inheriting characters.

Autosomal-dominant type of inheritance:

- both men and women fall ill in an equal degree;
- patients are in every generation;
- a sick child in sick parents;
- a probability of inheriting the character is 100 %, if one of the parents is homozygous, 75 % — if both parents are heterozygous, 50 % — if one parent is heterozygous and the other is homozygous on the recessive gene.

Autosomal-recessive type of inheritance:

- men and women fall ill in equal degree;
- patients are not in every generation;
- a sick child in healthy parents;
- a probability of inheriting the character is 25 %, if both parents are heterozygous, 50 %, if one parent is heterozygous and the other is homozygous on a recessive character, and 100 % if both parents are recessive homozygotes.

Linked with an X-chromosome dominant type of inheritance is similar to an autosomal-dominant one, except the fact that a male passes this character (with an X-chromosome) only to daughters.

Linked with an X-chromosome recessive type of inheritance:

- predominantly men fall ill;
- patients in every generation; a sick child in healthy parents
- a probability of inheriting the character is 25 % of all children; in boys — 50 %; in girls — 0 %, if both parents are healthy.

Holandric type of inheritance:

- patients in all generations;
- only men fall ill;
- all sons are ill in a sick father.

4. Twin method.

In 1876 F. Halton proposed a **twin method**. The method allows determining a role of heredity and environment for revealing a character in the human. The frequency of giving birth to twins is 1 %. Twins can be *monozygous* (MT). They develop from one zygote, have an identical genotype. If the twins are *di-zygous* (DT), they develop from different simultaneously fertilized ova. They have a similar but not identical as in siblings genotype.

Zygosity criteria in twins: in MT the sex, blood groups, pattern of skin coverings are always identical; in DT these factors may differ.

Similarity of twins on the studied character is called *concordance*, differences on this character — *discordance*.

To reveal a share of heredity and environment in the development of a definite character a Holtsinge formula is used:

$$H = \frac{\text{CMT \%} - \text{CDT \%}}{100 \% - \text{CDT \%}}$$

where H — a heredity share; CMT — concordance in monozygotic twins; CDT — concordance in dizygotic twins.

If $H = 1,0$, only heredity is responsible for the character development; if the amount of H approaches to 0 — the environment is mainly responsible for the character development.

5. Cytogenetic method.

A cytogenetic method is based on microscopic *study of the karyotype*. Lymphocytes, bony marrow cells are obtained and grown on trophic cultures. The mitotic cellular division is stimulated, stopped in the metaphase, the cells are treated with NaCl hypotonic solution, chromosomes are stained. They are studied under microscope, their pictures are taken and ideograms are analyzed. To detail a karyotype and map chromosomes a fluorescent analysis is used. The method reveals *genomic and chromosomal mutations*. Special designations are assumed to record mutations: q — a long chromosomal arm, p — a short chromosomal arm, «+» — redundancy of genetic material, «-» — insufficiency of genetic material. The record of a male karyotype with Down's syndrome — 47,XY,21+.

6. Biochemical methods.

Biochemical methods are used for revealing hereditary metabolic diseases on enzyme activity or on the quantity of the final product of reaction that is catalyzed by this enzyme. Chromatographic, fluorometric, radio-immunological and other methods are used to reveal gene mutations (causes of metabolic diseases). For example, phenylketonuria — the impairment of phenylalanine exchange (PhA). Phenylketonuria can be revealed by the content of phenylalanine in blood: in healthy people it is 1–2 mg %, in sick ones — 50–60 mg %. Every 30–40th person is a carrier of a phenylketonuria gene.

Heterozygosity can be revealed in injection of phenylalanine into the organism and its content in the blood is determined. If after injecting PhA the curve of its content slowly returns to its norm, a person is heterozygous on a phenylketonuria gene.

7. Methods of a recombinant DNA. The program «Human genome».

Methods of a recombinant DNA (**molecular-genetic**) allow determining a pathologic gene in the genome. Stages of the methods:

1. DNA specimen are cut by restrictases into short fragments having a point of recognition.
2. The received fragments are separated by electrophoresis in an agar jelly into fractions differing in size (a molecular mass).
3. A needed number of copies of DNA fractions is obtained with a PCR.
4. Heat denaturation is conducted of a multiplied fraction of a double-sequenced DNA into single-sequenced fragments.

5. These fragments are placed into the culture with a radioactive probe (a single-sequenced DNA corresponding to a pathologic gene). If there is a complementary pathologic gene to the probe among these fragments, a two-sequenced DNA is formed.

6. The result is registered with an X-ray sensitive film.

In 1990 an international project on making a genetic human map (Human Genome Project) was started. The tasks of the «Human Genome» program included decoding of a nucleotide sequence (sequencing) of a human DNA molecule. In 2000 the human genome was sequenced.

Basic terms and concepts:

1. **Dizygous twins** — develop from two ova fertilized by spermatozoa.
2. **Monozygous twins** — develop from one fertilized ovum.
3. **Discordance** — a degree of twins' difference on a studied character.
4. **Concordance** — a degree of twins' similarity on a studied character.
5. **Proband** — a person, from whom making a genealogy starts.
6. **Sequencing** — determination of a nucleotide sequence in the gene.
7. **Genealogy** — a genealogic map, where all relatives of the proband and relative ties between them are denoted by symbols.

CLASSES II

1. Modeling methods. A law of N. I. Vavilov.

Biological modeling is studying hereditary human abnormalities on animals with similar impairments (hemophilia in dogs, diabetes mellitus in rats, etc). The method is based on a law of homologous rows of N. I. Vavilov: **close genera and species have similar rows of hereditary variation. Knowing forms of variation of one species, one can presume identical forms in other species or genus.**

Mathematical modeling is used in population genetics during determination of frequency of genes and genotypes in populations under different conditions of the environment.

2. Characteristic of human populations. Types of marriage.

Population is a group of species of one type having a common genotype, who are capable of free crossing, inhabit one territory for a long time and are relatively isolated from other individuals of the species.

Populations can be great and small. *Great* human populations contain over 4000 individuals. *Dems* and *isolates* — are *small populations*. The number of individuals in *dems* is 1500–4000 people, intergroup marriages in them compose 80–90 % and the inflow of genes from other groups is 1–2 %. *Isolates* contain up to 1500 people, intergroup marriages are over 90 %, the inflow of genes from other groups is less than 1 %. Marriages among relatives — *inbreeding (incest)*

marriages) are observed in dems and isolates. There is a high probability of homozygosity in relatives on one and the same pathologic gene; manifestation of hereditary pathology is possible. Outbreeding — incongeneric marriages. They sustain a high level of heterozygosity, and hereditary pathology occurs there far more rarely.

Human populations are characterized by demographic factors: the number, birthrate, mortality rate, age and sex structure, occupation, ecologic state of the environment. The action of evolutionary selection is decreased there and destruction of isolates takes place.

3. Genetic processes in great populations. The law of Hardy-Weinberg.

Great populations are called *panmixed*, as the choice of a partner for marriage is not limited there. Great in their number populations approach to an *ideal* one, which is characterized by a great number, isolation from other populations of the species; complete panmixing; absence of mutations and evolutionary selection.

The law of Hardy-Weinberg: In an ideal population frequencies of genes and genotypes are in equilibrium and do not change in a number of generations.

Great populations are characterized by genetic polymorphism (AA, Aa on a definite character) and panmixia. Nine variants of marriages are possible under such conditions (taking into account genotypes):

Genetic records of marriages and fillies:

1. AA x AA → AA.
2. AA x Aa → AA + Aa.
3. AA x aa → Aa.
4. Aa x AA → AA + Aa.
5. Aa x Aa → AA + 2Aa + aa.
6. Aa x aa → Aa + aa.
7. aa x AA → Aa.
8. aa x Aa → Aa + aa.
9. aa x aa → aa.

	f	AA	Aa	aa
m				
AA		1	4	7
Aa		2	5	8
aa		3	6	9

Summary: 4AA + 8Aa + 4aa or AA + 2Aa + aa

If one denotes genes frequencies as A-**p**, a-**q**, of genotypes as AA-**p²**, Aa-**2pq**, aa-**q²**, we'll get the following record: **p + q = 1** and **p² + 2pq + q² = 1**.

4. Genetic processes in small populations.

There appears a **genes drift** — **incidental fluctuations of genes frequencies**. It is the accumulation of homozygotes of homozygous individuals. In the first generation (AA + 2Aa + aa) heterozygotes comprise 50 %, in F₂ their number will be 25 %, in F₃ — 12,5 %, etc. When lethal genes are present, the population comes to extinction due to homozygotization. Evolution in small populations is impossible, there is no genetic diversity.

Mutation process — is an incidental and undirected process. It sustains a high degree of heterogeneity of populations. Mutations can be neutral, negative or positive for the organism. When the environmental conditions change, neutral mutations can become positive or negative. Mutation frequency of a gene is 10^{-5} – 10^{-7} per generation. Dominant mutations are revealed already in the first generation and are immediately exposed to evolutionary selection. At first recessive mutations accumulate in the population and are revealed phenotypically only after the appearance of recessive homozygotes, then evolutionary selection affects them. Mutations present an **elementary evolutionary material**.

Population waves or life waves — are periodical fluctuations of the number of natural populations due to fluctuations of environmental factors. Population waves change the genetic structure of populations removing the least adapted individuals from them.

Isolation — is a limitation of free crossing. It leads to separation of the population into separate groups and changing the genotype frequency. Types of isolation:

1. Geographic or territorial (mountain ridges, rivers).
2. Biological:
 - genetic or hybrids sterility;
 - ecologo-etological (unlikeness to meet a partner);
 - morpho-physiological or impossibility to cross due to morphological differences of sex organs.

Migration of the population may increase heterozygosity in human populations. *Immigration* introduces new alleles or new genotype combinations into the population. *Emigration* changes the ratio of different genotypes in the population due to the «outflow» of genes.

Evolutionary selection is the most important evolutionary factor. It removes less favorable combinations of genes from the population and selectively preserves more favorable genotypes changing genes frequency in populations. Three forms of evolutionary selection are distinguished — stabilizing, moving and disrupting.

5. Genetic load and its biological nature.

Saturation of populations with recessive mutations reducing adaptability of separate individuals to the environment, is called a *genetic load* of the population. A part of genetic load is passed from generation to generation (heterozygous carriage of pathologic recessive genes), other mutations arise in every new generation under the effect of mutagenic factors. The amount of genetic load is proportional to the contamination degree of the environment (5 %).

6. Methods of prenatal diagnosis of hereditary diseases.

Indirect methods of prenatal (before birth) diagnosis — examination of a pregnant woman (obstetric-gynecological, genealogical, biochemical) and *direct* methods — examination of the fetus.

α -Phetoprotein (APP) — is an embryo-specific protein; it is produced by fetal cells and the placenta and passes into the mother's blood. Reducing of *α -phetoprotein* at the 13–15th weeks of embryonic development is characteristic of chromosomal diseases. Its concentration is elevated in a threatening miscarriage, intrauterine death of the fetus, plural pregnancy, nerve tube defects, congenital nephrosis.

Ultrasonography is referred to *direct non-invasive methods* (without tissues injury), it is the usage of super sound for obtaining an image of the fetus and its membranes. It is used for all pregnant women, because it is safe for the fetus and can be repeated. This method reveals vitality of the fetus, twin pregnancy and severe development defects of the brain and spinal cord and the skeleton.

Indications for diagnosis using *direct invasive methods*:

- the presence of a hereditary disease in the family;
- mother's age over 37 years; presence of an X-linked recessive disease in the mother;
- presence of spontaneous abortions in women at early stages of pregnancy, cases of still births, children with multiple development defects and chromosomal pathology;
- heterozygosity of both parents, having one pair of genes each with an autosomal-recessive type of inheritance.

Direct invasive methods (with tissue injury):

1. Chorion-biopsy — taking chorion cilia through the uterine cervical canal for cytogenetic and biochemical investigations and DNA analysis. It is performed under control of ultrasonography at the 8–13th weeks of gestation. The method allows revealing genic, chromosomal and genome mutations.

2. Amniocentesis. At the 15–17th weeks under control of ultrasonography a puncture of the amniotic sac is made through the abdominal wall and 15–20 ml of amniotic fluid with fetal cells are taken with a syringe for diagnosis of various hereditary diseases. Complications in this method arise in 1 % of cases.

7. Express-methods.

Express-methods are methods of fast preliminary diagnosis of human hereditary diseases. These methods must be economic, safe and diagnostically significant; the material for investigation should be in small amounts and be easily accessible (blood, urine).

Gatry's microbiological test. A drop of blood of the newborn is put on blotting paper and put on the agar culture of bacteria containing anti-metabolite of phenylalanine. The anti-metabolite inhibits bacterial growth. But if the blood contains a lot of phenylalanine, anti-metabolite is destroyed, and microbes start their growth.

Determination of X- and Y-sex chromatin — the cheek epithelial cells or leukocytes are investigated. X-chromatin is determined during acetorceine stain-

ing, and Y-chromatin — with acrichine-yperite. A genetic sex is determined, chromosomal diseases of sex are diagnosed.

Biochemical and chemical (colored reactions) methods are used for fast preliminary diagnosis of hereditary metabolic diseases (10 % FeCl₃ solution for diagnosing phenylketonuria).

Dermatoglyphic analysis is a study of patterns on the skin of fingers, palms and feet. Dermatoglyphic patterns are very individual and do not change during life. There are patterns of three types on finger tips: an arch (A), a loop (L) and winding (W). There are tri-radii in interfinger spaces: a, b, c and d.

Near the bracelet fold is a palm tri-radius t. If one connects tri-radii a, d, t, we'll get a main palm angle; in norm it is not more than 57 %. The combination of radial loops on 4–5th fingers, amounts of the main palm angle of 60–86° and a four-finger furrow (it forms on fusion of an oblique and transverse line) allows suggesting a hereditary disease.

Basic terms and concepts:

1. **Amniocentesis** — a method of prenatal diagnosis: taking of amniotic fluid with fetal cells for biochemical and cytogenetic investigations.

2. **α -Phetoprotein** — is protein contained in amniotic fluid and blood serum of a pregnant woman.

3. **Dems** — are populations of people containing 1500–4000 individuals.

4. **Drift of genes** — incidental fluctuations of genes frequencies in small populations.

5. **Panmixia** — absence of limitations in choosing of a partner for marriage.

6. **Population** — a group of individuals of one species inhabiting the given territory, freely crossing with each other and isolated from other groups of individuals of this species.

7. **Gatry's test** — a preliminary method for diagnosis of phenylketonuria in neonates.

8. **Ultrasonography** — a diagnostic method using ultrasound for obtaining an image of the fetus and its membranes.

9. **Chorion-biopsy** — a method of prenatal diagnosis — taking of chorion cilia epithelium for cytogenetic and biochemical investigations and DNA analysis.

HUMAN GENETIC AND CHROMOSOMAL DISEASES

1. Genic mutations as a cause of metabolic diseases.

Genic mutations are revealed phenotypically in the human as hereditary metabolic diseases — *fermentopathies*. About 3000 such diseases are described. Their frequency in human populations is from 2 to 4 %.

Genic diseases may have the following causes:

- 1) mutations of structural genes — qualitative changes of proteins are observed, *abnormal proteins* are formed (for example, mutant forms of hemoglobin);
- 2) mutations of functional genes — the content of normal protein in the cell decreases, its *quantitative* changes occur.

Substances, which accumulate in the impairment of enzyme activity, may produce a toxic action or cause definite impairments of the structure and function of cells.

2. Characteristic of genic human diseases. Genic diseases are classified according to a character of metabolic impairment.

Impairments of amino acid exchange. Phenylketonuria is inherited on autosomal-recessive type. Its frequency is 1:10 000. The enzyme activity of phenylalaninehydroxylase is impaired. Phenylalanine does not transform into tyrosine and the phenylpyroacemic acid (PhPAA) forms; it is a poison for nervous cells.

Symptoms: «mice» smell, progressing mental retardation, increased excitation and muscular tone, hyperreflexia, tremor, convulsive epileptic attacks, weak pigmentation of the skin.

Diagnosis: Gatty's test, an express-method with FeCl_3 , biochemical methods (determination of PhPAA in the urine and of phenylalanine in the blood).

Treatment: diet-therapy (food without phenylalanine from the first weeks of life till 7–10 years).

Albinism develops in the absence of the *tyrosinase* enzyme. The *melanin* pigment does not form. Incidence frequency is 1:5000–1:25 000. Autosomal-recessive type of inheritance.

Symptoms: depigmentation of the skin, hair, eyes, photophobia, decreased sharpness of vision, increased sensitivity to UV rays, inflammatory diseases of the skin develop.

Diagnosis — clinical examination. Treatment is not elaborated.

Impairment of carbohydrate exchange. Galactosemia. Incidence frequency 1:100 000. Autosomal-recessive type of inheritance. The disease is caused by insufficiency of the enzyme, galactose-1-phosphatidyltransferase, which participates in metabolism of galactose.

Symptoms: hepatomegaly, jaundice, vomiting, diarrhea, retardation of psychic-motor development, cataract.

Diagnosis: a decreased content of glucose is revealed in the blood, the content of protein and galactose is increased in urine.

Treatment: exclusion of lactose from the food of a newborn.

Impairment of lipid exchange. Hyperlipoproteinemia is caused by the impairment of lipid exchange in the blood plasma (fatty acids, triglycerids, cholesterol) due to a defect of enzymes or cellular receptors. Incidence frequency of the disease 1:500. The type of inheritance is autosomal-dominant.

Symptoms: an increased level of cholesterol results in the development of arteriosclerosis, ischemic heart disease, early myocardial infarctions (33–45 years).

Diagnosis: determination of lipoproteins in the blood serum.

Impairment of purines exchange. Lesch-Nyhan's syndrome. Incidence frequency is 1:300 000. A recessive, linked with an X-chromosome syndrome. The disease is caused by insufficiency of the enzyme that catalyzes the attachment of purine bases to nucleotides, and they break down to the uric acid.

Symptoms: hypertone of muscles, oligophreny, inclination of the child to self-injuries, urinary calculi, deposits of the uric acid in joints.

Diagnosis: determination of the uric acid in the blood.

Impairment of mineral exchange. The disease of Wilson-Konovalov: incidence frequency 2:100 000. The type of inheritance is autosomal-recessive. The cause of the disease — insufficiency of the enzyme resulting in the impairment of ceruloplasmine synthesis, which provides copper transport. Copper concentration in the blood increases and it accumulates in the brain tissue and liver. The disease is revealed at school age.

Symptoms: hepatomegaly, jaundice, vomiting, cirrhosis of the liver, impairment of intellect, tremor, impairment of swallowing, muscular hypertone.

Diagnosis: determination of ceruloplasmine concentration in the blood serum.

Impairment of coagulation mechanisms. Hemophilia A: incidence frequency is 1:6500 of newborn boys. The type of inheritance is recessive linked with an X-chromosome. Cause of the disease: decrease of the activity of coagulation factor VIII (anti-hemophilic globulin A). The disease is revealed on the 2–3 year of life, sometimes — on birth (by bleeding from the umbilical cord and intracutaneous hemorrhages). Symptoms: hemorrhages, a hematome type of bleeding, hemarthroses (hemorrhages into a knee, elbow, mortis joint), gliding joints, blood in urine.

Diagnosis: determination of coagulation factor VIII of the blood.

Treatment: injection of coagulation factor and exchange transfusion.

Impairment of the hemoglobin molecule structure (hemoglobinopathies). Crescent cell anemia (HbS): in position 6 of a β -chain of hemoglobin the glutamine acid is replaced with valline. In hemozygotes on a mutant type erythrocytes take a sickle-like shape, there develops chronic hypoxia and anemia, hemolysis and breaking down of erythrocytes (a lethal outcome is possible). Heterozygous carriers of a HbS gene are healthy under usual conditions.

To diagnose genic diseases biochemical methods are used and methods of a recombinant DNA.

3. Chromosomal and genome mutations as a cause of chromosomal human diseases.

Chromosomal diseases are the result of chromosomal and genome mutations. Frequency is 0,24–0,4 %. About 90 % of chromosomal diseases are auto-

somal trisomies. Polyploidy, haploidy, trisomy on large chromosomes and all monosomies (except an X-monosomy) are lethal for the human. Diagnosis of chromosomal diseases is made after studying with cytogenetic methods. The most common are trisomies on the 13st, 18st, 21st pairs of chromosomes.

4. Characteristic of chromosomal human diseases.

Patau's syndrome (47, XX, 13+; 47, XY, 13+). Frequency is 1:6000. There are 2 cytogenetic variants: trisomy and Robert's translocation. Minimum diagnostic signs: microcephaly, polydactyly, a short neck, narrow eye slits, a sunken nose-bridge, a two-lateral cleft of the upper lip and palate, microphthalmia, deformed ear flaps. Children are born with the body mass under the norm (2500 g). In 80 % of newborns are heart defects, 65 % — abnormalities of the brain, 60 % — abnormalities of the kidneys, 50 % — defects of digestive organs. 95 % die before 1 year.

Edward's syndrome (47, XX, 18+; 47, XY, 18+) occurs with frequency of 1:7000. For women older 45 years the risk to give birth to a sick child is 0,7 %. A cytogenetic syndrome is presented by trisomy, rarely mosaic forms occur and a translocation form is an exclusion. Minimum diagnostic signs: reduced weight at birth (on an average 2100 g), abnormalities of the cranial and facial parts of the skull (step-like falling back of frontal bones in the region of the fontanel, the lower jaw and mouth opening are small, eye slits are narrow and short, ear flaps are deformed), a «rocking foot», defects of the heart and large vessels. Life span — 60 % of children die before the age of three months.

Down's syndrome (47, XX, 21+; 47, XY, 21+) is the most common chromosomal pathology — 1:750. Such children are more often born by mothers of 41–46 years, the probability to give birth to a sick child increases in them to 4,1 %. Cytogenetic forms: trisomy, a translocation form or mosaicism. Minimum diagnostic signs: mental retardation, muscular hypotony, a flat face, short neck, epicanthus, mongoloid eyes, thick lips, thickened tongue protruding from the mouth, defects of the cardio-vascular system and digestive organs. Life span is about 36 years.

«Cat's cry» syndrome (5p-) is due to a deletion of a short arm of the 5th chromosome. Population frequency — 1:45 000. Minimum diagnostic signs: a specific cry («cat's cry»), physical underdevelopment, mental retardation, microcephaly, a moon-like face, a broad nose-bridge, a short neck, strabismus, low-positioned ear flaps, bite abnormalities, muscular hypotony. Life span is reduced: only 14 % of patients live over 10 years.

Basic terms and concepts:

- 1. Hemophilia** — a disease associated with blood coagulation impairment.
- 2. Microphthalmia** — reduced sizes of the eye-ball.
- 3. Microcephaly** — reduced sizes of the brain.

4. **Monosomy** — absence of one chromosome from a pair in the karyotype, a variety of aneuploidy.

5. **Syndactyly** — atresia of finger phalanges.

6. **Trisomy** — a 3rd chromosome in a pair of homologous chromosomes.

7. **Fermentopathy** — hereditary metabolic diseases due to the impairment of synthesis and function of enzymes.

8. **Chromosomal diseases** — complexes of congenital defects caused by the impairment of the structure and number of chromosomes.

9. **Ceruloplasma** — the protein providing copper transport in the organism.

10. **Epicanthus** — a 3rd lid.

MEDICAL-GENETIC CONSULTATION

1. The aim and tasks of medical-genetic consulting.

Medico-genetic consulting is a compulsory component of prenatal prophylaxis of congenital defects and hereditary diseases.

The aim of medico-genetic consulting is the establishment of a genetic risk degree in the examined family and explanation of the medico-genetic conclusion to spouses.

Tasks of medico-genetic consulting:

- consulting of families and patients with hereditary pathology;
- prenatal diagnosis of congenital defects and hereditary diseases;
- assistance to doctors of various specialties in making a diagnosis, if genetic investigation methods are necessary;
- introduction of a territorial register of families and patients with hereditary and congenital pathology and their following-up;
- popularization of medical-genetic knowledge among the population.

2. Characteristic of the genetic prognosis stages.

1. *Determination of a genetic risk degree.* Genetic risk is a probability of appearing a hereditary pathology in fillies. There is a low risk degree — up to 5 %, an inconsiderably increased one — to 10 %, a moderate degree — to 20 % and a high risk degree — over 20 %. Depending on severity of medical and social consequences of this pathology, a moderate, increased and high risk degree is an indication for pregnancy interruption (medical abortion).

2. *Assessment of the severity of social consequences of the anomaly.* A risk degree not always corresponds to a severity of the expected disease. For example, polydactylism (a genetic risk degree is not less than 50 %) can be easily eliminated by a surgery. Phenylketonuria (a genetic risk degree is 25 %) is a severe disease and is hardly cured. The severity degree of this disease on social and medical consequences for the patient and his family is considered to be severe.

3. *Application of prenatal diagnosis methods.*

The decision concerning pregnancy interruption is taken by the spouses. The doctor only gives his recommendations.

4. Indications for referring a family couple to a medical-genetic consultation:

- the presence of similar hereditary pathology in some members of the family;
- sterility and a miscarriage in primary pregnancy;
- mental and physical retardation of the child;
- having the 1st child with development defects;
- primary amenorrhea (absence of periods) in underdevelopment of secondary sex characters;
- a contact of spouses with mutagenic factors;
- blood relationship of the spouses.

3. **Treatment principles of hereditary human pathology.**

At present the following approaches to treatment of hereditary diseases and diseases with hereditary predisposition are marked out.

1. **Symptomatic treatment**, when in all hereditary diseases separate symptoms are treated with medicines: antibiotics in inflammatory processes, pain killers — in pains, sedatives — in states of excitation.

Surgical treatment is often used in congenital defects: in stenosis of vessels and atresia, in polydactylism, heart defects, defects of the facial part of the skull.

2. **Pathogenic treatment** (in metabolic diseases):

- *exchange correction* — diet therapy in phenylketonuria and galactosemia);
- *metabolic inhibition* — synthesis suppression of the product, which is not excreted from the organism (uric acid in the Lesch-Nyhan's syndrome);
- *replacement therapy* — injection of the product not produced in the organism (growth hormone in dwarfism, insulin in diabetes mellitus).

3. **Etiological treatment** — elimination of the cause of the disease. A most perspective method is the possibility to replace mutation genes using genetic engineering methods.

Genic therapy:

1. Using anti-sense oligonucleotides (ASOG). They are short nucleotide sequences, complement to fragments of mRNA or nuclear DNA.

Linking with a target (promoter or mRNA), ASOG blocks synthesis of a pathologic protein.

2. Application of ribosimes — polyribonucleotides having enzyme (ribonuclease) activity. The presence of a specific nucleotide activity in ribosimes allows inserting nucleotides in them, complementary mRNA of viruses and destroying them.

3. Implanting genes into a nuclear DNA of somatic cells for treating tumor diseases (the patients are injected their own tumor cells with genes of tumor necrosis or with genes of interleukins activating lymphocytes and macrophages).

Basic terms and concepts:

1. Genetic risk of a light degree — the probability of appearing a hereditary pathology in fillies is up to 10 %.

2. Genetic risk of a moderate degree — the probability of appearing a hereditary pathology in fillies is up to 20 %.

3. Genetic risk of a high degree — the probability of appearing a hereditary pathology in fillies is over 20 %.

4. Diet therapy — treatment with the help of a diet.

5. Metabolic inhibition — synthesis suppression of the product not excreted from the organism.

6. Genic therapy — treatment using genetic engineering methods

7. Replacement therapy — injection of hormones and enzymes not produced in the organism.

8. Pathogenic therapy — is used in metabolic diseases for correction of metabolic impairments.

9. Symptomatic therapy — treatment of separate symptoms (signs) of a hereditary disease or a congenital development defect.

10. Etiological therapy — treatment for elimination of the cause of the disease.

REPRODUCTION OF ORGANISMS

1. Forms of reproduction, their characteristic.

Reproduction is a universal organism property of all living things, which provides reproduction of their own selves and is based on transmission of genetic information from generation to generation.

Replication on a *molecular level* is a DNA replication, on a *subcellular level* — doubling of some organoids, on a *cellular one* — amitosis, mitosis. Cellular division is the basis of *organisms' reproduction*.

Forms of reproducing organisms. The characteristic of asexual reproduction: 1 parental individual takes part in reproduction; somatic cells are a source of genetic information; genotypes of daughter cells are identical to parental ones; the number of individuals grows fast; it ensures the species existence in unchanging environmental conditions (fig. 11).

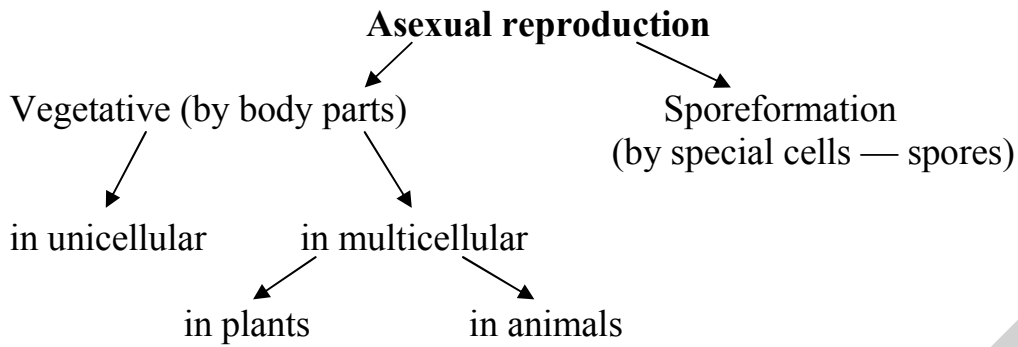

Fig. 11. Asexual reproduction

Vegetative reproduction of unicellular organisms:

a) *division into two* (longitudinal division — in euglenas, transverse — in infusorians);

b) *schizogony* — is a multiple division — at first the nucleus is divided into multiple parts, then the cytoplasm (in a malaria plasmodium);

c) *budding* — a bud forms on the mother's cell, it grows and separates from the mother's individual (yeast, sucking infusorians).

Vegetative reproduction in multicellular organisms:

A. *In plants* — by vegetative organs: the root, stem, leaves.

B. *Animals:*

a) *budding* (hydra);

b) *fragmentation* — division of the body by constrictions into several parts (cilia and ring worms);

c) *polyembryony* — division of the germ into several parts, each forming an integral organism (suckers).

Sporeformation: in special organs (sporogonies) spores are formed, they give start to a new organism (water-plants, mushrooms, mosses, lycopodium, horse-tail, ferns).

Characteristic of sexual reproduction: 2 parental individuals take part in reproduction; parental sex cells are a source of genetic information; genotypes of daughter cells differ from the parental ones due to combinative variation; it promotes the adaptability of organisms to changing environmental conditions (fig. 12).

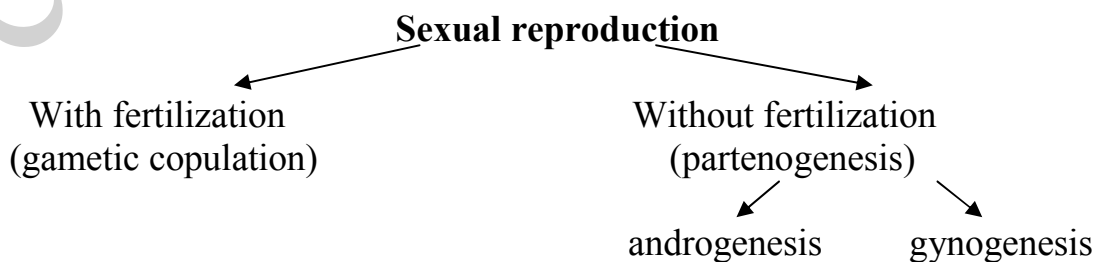

Fig. 12. Sexual reproduction

2. Evolution of the sexual process.

A **sexual process** is the bases of sexual reproduction. *Conjugation* is exchange of genetic information between unicellular organisms. *Copulation* is joining the genetic information of two cells. The increase of the number of individuals is not observed in the sexual process.

Conjugation is characteristic for infusorians and bacteria. During conjugation infusorians are linked with a plasmatic bridge and exchange micronucleus parts. Then they diverge and multiply in asexual way. At a definite period of their life cycle the organisms of protists perform a function of gametes. They fuse (the copulation occurs) and then multiply by division.

The copulation in sexual reproduction is called *gametic*.

3. Gametes structure.

Ova have a rounded or oval shape from 60 μ m to some cm in diameter. They are immovable, contain organoids and a store of nutrients (yolk). Their cytoplasm is species-specific. Ova are covered with membranes, in mammals — also with follicular epithelial cells.

Types of ova:

- *isolecital* — there is a small amount of yolk, it is evenly distributed (the Lancelet, mammals);
- *sharply telolecital* — there is a lot of yolk, it is located on the vegetative pole, and both the cytoplasm and the nucleus are on the animal pole (reptiles, birds);
- *moderately telolecital* — in fish and amphibians;
- *centrolecital* — there is little amount of yolk, it is in the center (insects).

A **spermatozoon** consists of a head, neck and tail. The sizes of a human spermatozoon are 52–70 μ m. There is an *acrosome*, a modified Golgi's complex, at the end of the head. It provides the permeation of a spermatozoon into the ovum. The main part of the head is occupied by the nucleus surrounded by a thin layer of cytoplasm. There is a centrosome and a spiral thread consisting of mitochondria producing energy for movements of the tail in the neck.

4. Gametogenesis (oogenesis and spermatogenesis).

Depending on the presence and functioning of sex glands in the organism there are hermaphrodites and organisms with separate sexes.

The **hermaphrodite** is an organism having both male and female gonads forming both spermatozoa and ova. Such hermaphroditism occurs in flat and ring worms. It is a *true* hermaphroditism. In case of a *false* hermaphroditism, sex organs and secondary characters of both sexes develop in one individual and gonads are of one sex (male or female). The human may have a false hermaphroditism.

Organisms with separate sexes have either female or male gonads. Males and females are characterized by the characters of **sexual dimorphism**: differences in body sizes, coloration, structure, voice specificities, behavior and other characters. *The characters of sexual dimorphism in the human are peculiarities*

of the bony-muscular system: distribution of subdermal adipose cellular tissue; the degree of hair covering development; voice timbre; peculiarities of behavior, etc.

The process of ova formation is oogenesis, that of spermatozoa — *spermatogenesis*. In gametogenesis, haploid gametes are formed from diploid somatic cells of sex glands (fig. 13).







Genetic information	Cells names	Spermatogenesis	Ovogenesis	Cells names	Periods
2n2chr4c	spermatogonies			ovogonia	Reproduction (mitosis)
2n2chr4c	Spermatocytes of the 1 st order			Ovocytes of the 1 st order	Growth
1n2chr2c	Spermatocytes of the 2 nd order			Overocytes of the 2 nd order and reductive bodies	Maturation (meiosis)
1n1chr1c	spermatides				Formation
1n1chr1c	Spermatozoa			Ovum	Gametes

Fig. 13. Gametogenesis

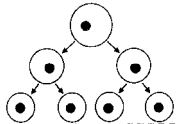
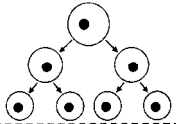
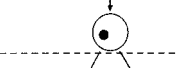
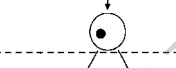
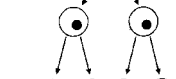
Peculiarities of human gametogenesis:

1. Mitotic division of oogonies is completed before birth of the organism. Mitosis of spermatogonies starts with puberty.

2. A growth zone is clearly marked during oogenesis.

3. In oogenesis the 1st division of mitosis stops at the prophase diakinesis stage before puberty. The 2nd division of meiosis stops at the metaphase stage and completes after fertilization.

4. There is no zone of formation in oogenesis, in spermatogenesis the formation zone is clearly marked.

5. A newborn girl has about 30 000 oocytes in her ovaries, of them only 300–400 reach their maturity (about 13 cells a year).

6. During the period of sexual life a male organism produces up to 500 billion spermatozoa.

5. Insemination, its forms. Fertilization and its stages.

A number of processes that provide a contact of female and male gametes is **insemination**. Water animals have an *external insemination*: gametes are excreted into the water, where their fusion occurs.

In an *internal insemination* (in ground animals), male gametes are injected into the sexual ways of a female during an intercourse.

The insemination process is followed by fertilization: fusion of gametes with a zygote formation. A contact of gametes is provided by:

- opposite charges of gametes;
- movement of spermatozoa and wall contraction of female sexual ways;
- excretion of gammons by an ovum, to which spermatozoa have a positive chemotaxis.

An external stage of fertilization — is permeation of a spermatozoon into an ovum. During the contact with the ovum a spermatozoon acrosomal membrane is destroyed and the enzyme *hyaluronidase* is excreted.

The enzyme dissolves the ovum membrane, an acrosomal thread is thrown from the acrosome; it permeates through egg membranes and fuses with the ovum membrane. A *receiving protuberance* is formed in this part of the ovum; it catches and carries the head and centriole of the spermatozoon into the ovum cytoplasm. The ovum can be permeated by one spermatozoon (in mammals), then it is *monospermy*.

If several spermatozoa enter the ovum (in insects, fish and birds), it is *polyspermy*. After spermatozoon permeation a fertilization membrane forms on the surface of the ovum and other spermatozoa can not get inside.

Syncaryogamy is associated with an **internal stage**; it is fusion of gametes haploid nuclei and formation of a diploid nucleus of a zygote.

A *male pronucleus* (spermatozoon nucleus) enlarges to the sizes of a female pronucleus (ovum nucleus), turns by 180° and moves to a *female pronucleus* with its centrosome. The pronuclei fuse, a diploid chromosomal complement restores and a zygote forms.

A special form of reproduction is **parthenogenesis**, the development of organisms from unfertilized ova. A *natural parthenogenesis* occurs in lower cancroids, bees, butterflies, rock lizards. Nuclei of somatic cells in such individuals can be haploid. A diploid complement restores in fusion of the ovum nucleus with the nucleus of the directing body.

6. Biological peculiarities of human reproduction.

Peculiarities are:

1. The human is not only biological but also a social being.
2. The ability for reproduction appears with puberty. Its signs are first periods in girls (on an average from 12–15 years) and pollutions in boys (from 13–16 years).
3. The duration of the reproductive period in women is to 40–45 years, in men — to an old age (gamete production by the testes occurs during the whole life).
4. During one intercourse about 200 million of spermatozoa are excreted with the semen fluid.
5. On coming puberty one oocyte of the 2nd order is formed once a moon month.

6. Fertilization occurs in upper parts of the uterine tubes, usually during the first 12 hours after ovulation.

7. Spermatozoa retain their ability for fertilization during 1–2 days after getting into the female sexual ways.

8. Human reproduction, unlike that of animals, is not seasonal. It depends on a number of social-economic factors.

9. The human can regulate birthrate.

Basic terms and concepts:

1. Acrosome — is a modified Golgi's complex of a spermatozoon.

2. Conjugation — a sexual process, when exchange of genetic information between two cells occurs.

3. Copulation — is a sexual process, when joining of genetic information of two individuals occurs.

4. Oogamy — is a form of copulation with a strict differentiation of gametes: a large and immovable ovum and a small and movable spermatozoon.

5. Oogenesis — is a process of development of maturation of ova.

6. Insemination — are processes ensuring gametes contact.

7. Fertilization — is fusing of an ovum and a spermatozoon with further formation of a zygote.

8. Partenogenesis — is sexual reproduction without fertilization.

9. Sexual process — is exchange of genetic information between two cells or joining the genetic information of two cells; increase of the number of individuals is not observed.

10. Syncarion — is a nucleus of a zygote formed as a result of fusion of gametic nuclei.

11. Spermatogenesis — is a process of spermatozoa development.

BASES OF ONTOGENESIS (EMBRYONIC DEVELOPMENT)

1. Ontogenesis, its types, division into periods.

Ontogenesis — is individual development of the organism from a zygote formation to its death.

Division of ontogenesis into periods (fig. 14).

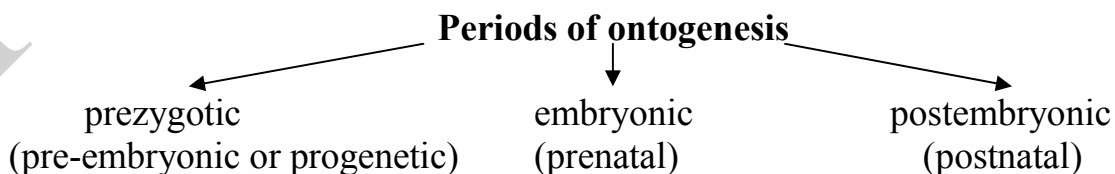

Fig. 14. Periods of ontogenesis

The pre-zygote period — is a period of formation and maturation of those parental sex cells that will form a zygote in future.

The embryonic or prenatal period starts with the moment of a zygote formation and ends with birth of a new organism or its leaving egg membranes.

The post-embryonic or post-natal period — lasts from birth of an organism or its leaving egg membranes and to death.

2. Characteristic of pro-genesis.

Pro-genesis of a female sex cell, that is a basis for a zygote formation, starts in the embryonic period of the mother's organism; that is why the older is the woman, the longer is this period. Usually its length coincides with the mother's age. Pro-genesis of a spermatozoon, that will be a basis for a zygote formation, is about 70 days. The quality of gametes, the presence of two mutant genes there produce a considerable effect on health of future fillies.

3. Division of the human embryonic development into periods.

Embryogenesis of the human includes:

1. Germinative or initial period — the 1st week after fertilization, a zygote is being split.

2. Embryonic period — the 2nd-3rd weeks after fertilization, a blastule and a gastrule are formed, germinal layers and axial organs are being germinated.

3. Pre-fetal period — the 4–8th weeks, formation of germs of all organ systems and the placenta.

4. Fetal period — from the 9th week an embryo is called a fetus; growth of the fetus is going on, its organs and organ systems are being formed.

4. Characteristic of embryogenesis stages. Provisional organs.

Zygote is a unicellular development stage of a multicellular organism; it was formed on fusion of a male and female gamete.

The type of **splitting a zygote** is determined by an ovum type that depends on the amount of nutrients (yolk) and their distribution. Cells that are formed in splitting are *blastomeres*. The process of splitting a germ in some animals reminds a raspberry (**morula**). Blastomeres of the morula are located on the periphery in one layer and form a **blastula** — a one-layer germ with a cavity inside. This layer of cells is called *blastoderma*. The cavity of the blastula is a *blastocoel*.

The blastula stage is followed by **gastrulation** — formation of a gastrula, a two-layer germ. The cell layers of the gastrula got the name of germinal layers. There are 4 types of gastrulation (fig. 15).

Invagination — is drawing in: the vegetative pole of the blastula is drawn inside, taking place under the animal pole. A 2-layer germ is formed: an external layer got the name of *ectoderm*, an internal one — *entoderm*. The gastrula cavity is called gastrocele or a primary intestine. Entrance to the intestine is a primary mouth or a blastopore. Its edges form an upper and lower lip of the blastopore.

In secondary-mouthed (echinodermata and chordates) it becomes an anal opening and the mouth is formed on the opposite end of the germ.

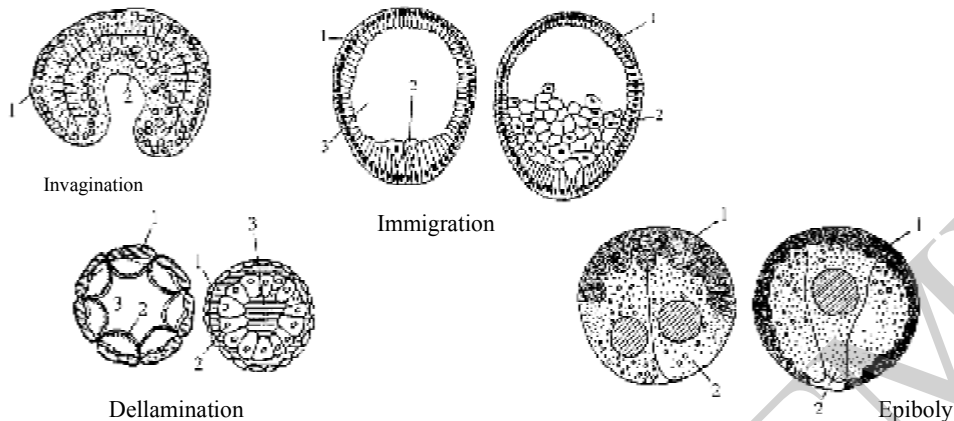

Fig. 15. Ways of gastrulation:
1 — ectoderm; 2 — entoderm; 3 — gastrocele

Immigration — is «eviction» of some cells into the germ's cavity and formation of a second layer there — entoderm.

Epiboly — over-growing: the animal pole cells are divided faster than the vegetative pole cells that become the endoderm.

Delamination — splitting: all cells of one germinal layer are divided parallel to its surface and form 2 layers — the ectoderm and endoderm.

Gastrulation in the human goes on a mixed type — some of its forms combine simultaneously.

All animals (except sponges and coelenterate) have three layers. Germination of the 3rd germinal layer, **mesoderm**, occurs in two ways: *teloblastic* and *enterocelic*. The *teloblastic way* is characteristic of invertebrates. There forms one large cell, a *teloblast*, on both sides of the intestine near the blastopore. They start dividing; small cells take place between the ectoderm and entoderm and form the mesoderm. The *enterocelic way* is characteristic for chordates. There are formed bulges, *pockets* (celomic sacs) on two sides of the primary intestine. They become separated from the primary intestine, over-grow between the ectoderm and entoderm and give start to the mesoderm. After the formation of germinal layers germination of axial organs occurs; it is *histogenesis* — a process of tissue formation and *organogenesis* — a process of organ formation.

Derivatives of germinal layers. The ectoderm gives start to the epidermis and its derivatives, nervous system, sense organs, initial and final parts of the digestive tube.

The chord, middle part of the digestive tube, liver, pancreas and respiratory system are formed from the **entoderm**.

The following organs and systems are formed from the **mesoderm**: the connective and muscular system, skeletal muscles, the skeleton, derma,

dentin, urogenital system, smooth musculature, heart, blood vessels, blood, lymphatic system.

Provisional (temporary) organs of the germ:

1. *Amnion* — is a sac filled with the fluid that forms water environment, protects the germ from drying and injuries.

2. *Chorion* (a serous membrane) is an external membrane adjacent to shell or mother's tissues. It serves for exchanging nutrients with the external environment.

3. *Yolk sac* takes part in feeding of the germ and is a blood-making organ.

4. *Allantois* is a process of the back intestine, a receptacle for urea and the uric acid. In mammals it forms the placenta together with the chorion.

5. Realization of genetic information in the prenatal period.

Genetic information (sequence of DNA nucleotides), provides synthesis of mRNA, proteins-enzymes that stipulate the development of characters. Manifestation of genes action depends on other genes. They can affect the given gene, protein-enzymes coded by this gene, manifestation of the character. This gene can affect the realization of other genes action. The realization of the gene action is also affected by environmental factors that can modify the structure of DNA, mRNA, proteins-enzymes and phenotypical manifestations of the gene (fig. 16).

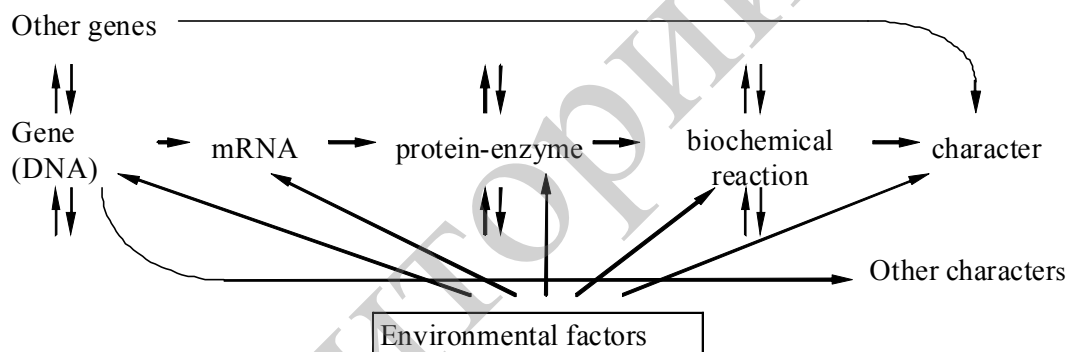

Fig. 16. Realization of genetic information

6. Mechanisms of embryogenesis. Morphogenesis.

Mechanisms ensuring embryogenesis:

1. **Differential activity of genes** — various blocks of genes have a strictly definite order of repression and depression during embryonic development.

2. **Determination** — obtaining the ability to develop in a definite direction by the cells and simultaneous limitation of their future development possibilities. At the beginning of embryogenesis blastomeres are *totipotentious* (can give start to a whole organism) and their development depends on external inductors and adjacent cells. At later stages of embryogenesis cells become determinant (their development is predetermined) and they develop according to a given plan.

3. **Differentiation** — is a biochemical, functional and morphological specialization of cells; modification of a developing structure, when relatively homogenous formations become more and more different.

Phases of differentiation:

- *dependent* (to the stage of an early gastrula);
- *independent* (at the stage of a late gastrula).

Genetic bases of differentiation. Genetic differentiation is associated with universality of an ovum and inhomogeneity of its cytoplasm — different parts of the cytoplasm have a *different complement of chemical substances* and possess different development possibilities.

Stages of differentiation (fig. 17).

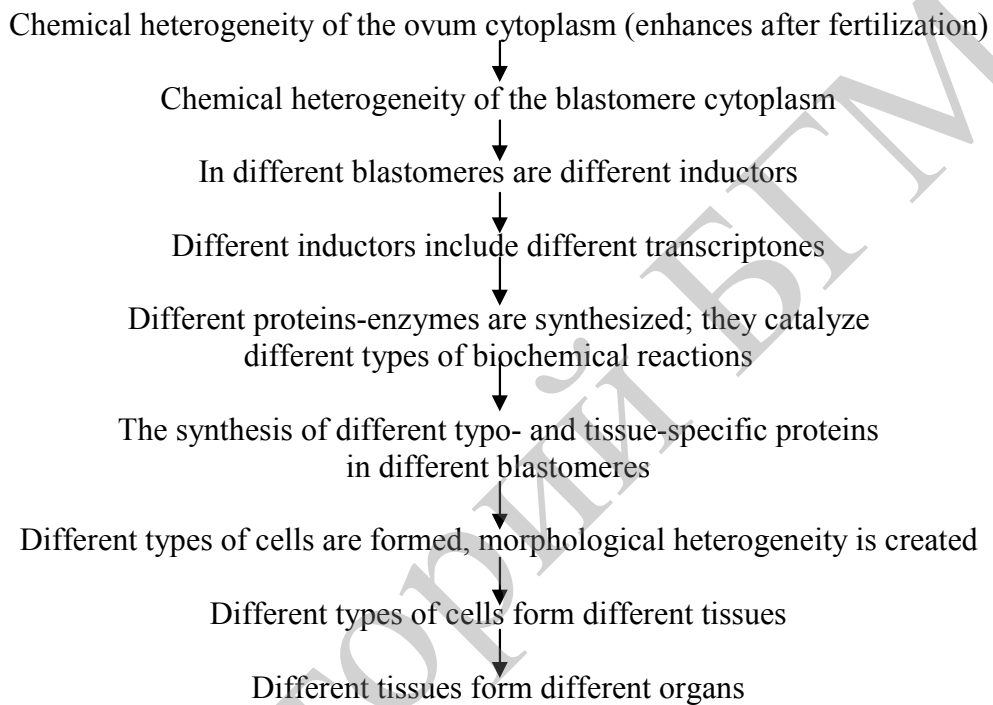

Fig. 17. Stages of differentiation

4. **Morphogenesis** — is a process of appearing new structures and modification of their form in ontogenesis.

Mechanisms of morphogenesis:

1. **Embryonic induction** — is influence of a group of embryonic cells on adjacent cells (G. Shpeman, G. Mangold). The primary inductor (*an upper lip of the blastopore*) determines the nervous tube formation, then the chord development is induced, and after this — that of the digestive tube.

2. **Morphogenetic fields** (A. G. Gurvich) — are distant cellular interactions of the electric or gravitational nature.

3. **Gradient of physiologic activity** (Ch. Child) — the intensity of substances exchange in the head department of the germ is higher than in the caudal one.

4. **Positional information of the cell** — due to intercellular interactions every cell assesses its own position in the germ of an organ and then differentiates according to this position.

7. Critical periods of the prenatal ontogenesis. Teratogenesis.

Periods of the greatest sensitivity of the germ to environmental factors are called **critical periods**.

The human has 3 basic critical periods in embryogenesis:

- 1) *implantation* — instillation of an embryo in the mucus of the uterus (6–7th day after fertilization);
- 2) *placentation* — the beginning of the placenta formation (14–15th day after fertilization);
- 3) *delivery* — coming out of the mother's organism, reconstruction of all organ systems, modification of the way of feeding (39–40th week).

Critical periods coincide with transitions from one development period to the other and modified existence conditions of the germ.

The process of the natural course impairment of embryogenesis under environmental factors is called **teratogenesis** (Greek *teras* — monster).

Factors causing teratogenesis are *teratogens*. They are medicines (antibiotics, quinine, chloride, anti-depressants, etc.), alcohol, nicotine, waste products of parasites, ionizing radiation.

Causes, development mechanisms of development defects are studied by teratology. Incidence frequency of development defects in human populations is 1–2 %.

Variants of congenital development defects: aplasia (hypoplasia), hypo- (hyper) trophy, heterotopy, atresia, stenosis, etc.

Basic terms and concepts:

1. **Aplasia** — absence of an organ.
2. **Atresia** — imperforation of natural openings and canals.
3. **Blastula** — a one-layer multicellular germ with a cavity inside.
4. **Gradients of physiologic activity** — intensity of exchange processes in the head department of the germ are higher as compared to the caudal department.
5. **Critical periods** — are periods of the greatest sensitivity of the germ to environmental factors.
6. **Morphological fields** — distant cellular interactions of the electric or gravitational nature.
7. **Ontogenesis** — an individual development from a zygote formation to death.
8. **Progenesis** — the period of formation and maturation of those sex parental cells that form a zygote.
9. **Stenosis** — narrowing of a hollow organ canal.
10. **Teratogenesis** — the impairment process of a natural course of embryogenesis under environmental factors.
11. **Embryonic induction** — the effect of a group of embryonic cells on adjacent cells.

BASES OF ONTOGENESIS (POSTEMBRYONIC DEVELOPMENT)

1. Postnatal ontogenesis. Types of development. Metamorphosis.

Post-embryonic (postnatal) period — is a period from the moment of birth or coming out of egg membranes and to death. After morphogenesis comes puberty and reproduction takes place; a final stage of ontogenesis is getting old and death.

Types of development (tab. 3).

Table 3

Types of ontogenesis

Direct development	Indirect development (with metamorphosis)
Laying eggs with a great amount of yoke (birds)	Incomplete metamorphosis, stages: egg – larva – mature individual (intestinal helminthes)
Intrauterine (mammals)	Complete metamorphosis, stages: egg – larva – chrysalis – mature individual (butterflies, 2-wing insects)

2. Division of the postnatal human ontogenesis into periods.

Neonatal period (1–10 days): a complex period of reconstruction of the whole organism, adaptation to new existence conditions.

Breast-feeding period (11 days – 12 months): feeding the child with mother's milk; intensive growth.

Early childhood period (1–3 years): the child learns to walk and speak, gets acquainted with the surrounding world.

The 1st childhood period (4–6 years): the child is interested in everything and tries to understand everything, masters elementary game skills.

The 2nd childhood period (7–11 years in girls, 7–12 years in boys): the growth becomes slow, intensive development of the muscular system; children go to school.

Adolescent period (12–15 years in girls, 13–16 years in boys): puberty starts and growth intensity increases.

Juvenile period (16–20 years in girls, 17–21 years in young men): puberty, growth and physical development have completed.

Middle age, I period (21–35 years in women, 22–35 years in men): an optimal period for childbirth; mastering professional skills.

Middle age, II period (36–55 years in women, 36–60 years in men): a period of the most active professional activity; the first signs of getting old appear after 35 years).

Advanced age (56–75 years in women, 61–75 years in men): the processes of aging are going on; retirement.

Senile age (76–90 years): senile changes are marked; some people retain the ability for creative work at this age.

Age of long-livers (over 90 years).

3. Critical periods of postnatal ontogenesis.

There are **critical periods** in the postnatal human ontogenesis:

1. *Neonatal period* (the first days after birth) — reconstruction of all organ systems for a new environment is going on.

2. *Puberty period* (12–16 years) — a hormonal reconstruction, formation of secondary *sexual* characters.

3. *Period of sexual wasting away* (about 50 years in women, 60–70 years in men) — functional fading of sex glands and the glands of internal secretion).

4. **Growth. Growth types of tissues and organs in the human. Acceleration.**

Growth — is enlargement of sizes and body mass. The growth can be **unlimited** (indefinite) — it lasts all life (cancroids, fish and reptiles) and **limited** (definite) — stops by a definite age (insects, birds, mammals).

The growth of the human has an uneven course. The most intensive growth is marked in the first year of life — it increases by 25 cm. In the 2nd year it increases by 10–11 cm, in the 3rd — by 8 cm. At the age from 4 to 7 years the growth increment is 5–7 cm per year. At a junior school age it is 4–5 cm per year, in puberty the growth intensity increases to 7–8 cm a year. Then the growth slows down and increases only 1–2 cm a year till the age of 20–25 years.

Basic growth types for tissues and organs:

- a *general* type: the whole body, muscles, skeleton, respiratory organs, liver have a maximum growth in the 1st year of life and in puberty;

- a *lymphoid* type: the thymus, lymphatic nodes and the lymphoid tissue of the intestine, spleen, tonsils; a maximum increase of their mass occurs till the age of 11–12 years and then involution;

- a *cerebral* type: the brain and the spinal cord, eyes, the head develop earlier than other parts of the body — after birth and to 10–12 years;

- a reproductive type: various parts of the reproductive system — a fast growth in puberty.

Growth regulation:

1. Somatotropin (a hypophysis hormone), thyroxin (a thyroid gland hormone).

2. Environmental factors: light, nutrition, vitamins (A, B, D), microelements, social-economic factors.

The somatotropic hormone is produced since the moment of birth till 13–16 years. When the gland's function is lowered, hypophysial nanism develops; when it is increased, gigantism develops — the human growth reaches 2 meters and more. Excretion of the hormone in an adult person results in acromegaly — bones enlargement of the hand, foot and face. *Thyroxin* increases energy exchange in the organism. The decrease of the gland's function leads to growth retardation, impairment of body proportions, retardation of sexual development, mental impairment. *Sexual hormones* produce effect on all metabolic

processes. *Environmental factors* produce a great effect on growth. Balanced nutrition is necessary for normal growth of the child. It should include vitamins and microelements. The sun light plays an important role in synthesis of vitamin D (calciferole).

During the last decades the **acceleration** of physical and physiological development of children and adolescents is marked. It is manifested already on the stage of intrauterine development — lengthening of the body of newborns by 0,5–1,0 cm, body mass by 50–100 g, the terms of teeth eruption change. The growth for the last 100 years has increased on an average by 8 cm. The following factors are considered to cause acceleration: mixed marriages (increase of heterozygosity), urbanization, increase of the radiation background, changes in the Earth magnet field and a number of social factors.

5. Age of the human.

Age:

1. *Biological* — the age he looks.
2. *Chronological* — the number of years a person has lived.

Criteria for determination of a biological age:

- skeletal maturity: ossification of various parts of the skeleton occurs at different ages;
- teeth maturity: appearance of milk teeth and their replacement with permanent ones occurs at a definite age;
- the time of appearing and the development degree of secondary sex characters.

6. Constitution and the human habitus.

Constitution of the human — are genetically conditioned peculiarities of morphology, physiology and behavior. In 1927 M. V. Chernorutsky proposed the classification including three types of constitution.

Ectomorphic type (asthenics): a narrow chest, low position of the diaphragm, elongated lungs, short intestines with low absorption, thin bones and long extremities, a thin layer of fat deposits. Asthenics are characterized by high excitability, inclination to neuroses, hypotonia, ulcers, tuberculosis.

Mesomorphic type (normosthenics): proportional constitution, moderate development of the hypodermal adipose tissue. Such people are energetic, alert, inclined to neuralgias, atherosclerosis and diseases of the upper respiratory tract.

Endomorphic type (hypersthenics): a broad chest, voluminous stomach and long intestines, a considerable fat deposit. The amounts of cholesterol, uric acid, erythrocytes and hemoglobin in the blood are increased. Assimilation processes predominate, they are inclined to obesity, diabetes mellitus, hypertension, diseases of kidneys and bladder.

Habitus includes peculiarities of morphology, physiology and behavior in a definite period. Habitus reflects well-being of a person and his health state at a given moment. It includes: peculiarities of the body build, pose, bearing, gait,

color of the skin coverings, expression of the face, concordance of a biological and chronological age.

7. Ageing of the organism. Basic theories of ageing.

Ageing — is a common biological regularity characteristic of all living organisms. Old age is a final stage of ontogenesis. The science about old age is called **gerontology**. It studies regularities of ageing of various organ systems and tissues. **Geriatrics** is a science about diseases of old people; it studies peculiarities of their development, course, treatment and prophylaxis.

Gerontology offers more than 300 hypotheses of ageing. The most common of them are:

1. *Energetic* (M. Rubner, 1908): the organism of each species has a definite energetic fund. It is being spent during the whole life, then the organism dies.

2. *Intoxicational* (I. Mechnikov, 1903): self-poisoning of the organism due to accumulation of products of nitrogenous exchange and putrefaction in the intestines.

3. *Associated with the connective tissue* (A. Bogomolets, 1922): the connective tissue is a nutrition regulator of cells and tissues; changes taking place there impair inter-tissue interactions and result in ageing.

4. *Overstrain of the central nervous system* (I. Pavlov, 1912. G. Celie, 1936): nervous break-downs and prolonged nervous overstrain cause untimely ageing.

5. *Changes of colloidal properties of the cellular cytoplasm* (V. Ruzhichka, M. Marinesku, 1922): a modified cytoplasm does not retain water properly, colloids from hydrophilic transform into hydrophobic, colloidal particles become bigger and their biological properties change.

6. *The programmed number of cellular mitoses* (A. Heiflick, 1965): different species have different numbers of cellular divisions: fibroblasts of human embryos give about 50 generations, the mice and hen has about 15 generations).

7. *Genetic*: accumulation of mutations: decrease of intensity and impairment of the processes of transcription, translation and repair; impairment of self-renewal of proteins.

A considerable impact on the process of human ageing has *social factors*, living conditions and way of life, various diseases. Ageing and the life span depend also on the ecological situation.

The science that studies a healthy style of life of the human and conditions increasing his life span is called **valeology**. A theoretically possible human age is 150–200 years; a maximum registered one is 115–120 years. An average life span of men in Belarus is 62–70 years, that of women — 72–79 years.

8. Clinical and biological death. Reanimation. Problems of euthanasia.

Ageing of the organism is terminated by **death**. Death ensures a change of generations. Causes of death can be different. *A physiological death*, or natural, occurs due to ageing. *A pathological death*, or untimely, is the result of a disease or an accident.

A clinical death occurs as a result of termination of vital functions (heart or respiration failure), but exchange processes of substances in cells and organs are retained.

A biological death is termination of processes of self-renewal in cells and tissues, impairment of chemical processes, autolysis and decay of cells. In the most sensitive cells of the brain cortex necrotic changes are revealed already in 5–6 minutes. To prolong the period of nearing a clinical death one can use general hypothermia of the organism that slows down metabolic processes and increases the persistence to oxygen starvation.

Reanimation — is a possibility to return a human to life from the state of a clinical death (when vital organs are not impaired) in 5–6 minutes, while cortical cells of the brain are still alive. Reanimation methods are used in medicine in any threatening conditions.

Euthanasia — is a medical assistance to pass from life for a terminally ill patient according to his will or request of his relatives. Euthanasia is allowed by law only in some countries.

Basic terms and concepts:

1. Acceleration — speeding-up of physical and physiological development of children and adolescents.

2. Valeology — a science that studies a healthy style of life of the human and conditions for enlargements of its duration.

3. Biological age — the number of years a person looks.

4. Chronological age — age confirmed by documents

5. Habitus of the human — peculiarities of morphology, physiology, behavior in a definite interval.

6. Geriatrics — a science about diseases of old people; studies peculiarities of their development, course, treatment and prophylaxis.

7. Gerontology — is a science about old age.

8. Constitution of the human — is genetically conditioned peculiarities of morphology, physiology and behavior.

9. Metamorphosis — is transformation of larval organs into organs of an adult organism.

10. Reanimation — is a possibility to return a person to life from the state of a clinical death.

11. Euthanasia — is medical assistance for passing from life to a terminally ill patient according to his wish of request of his relatives.

INTRODUCTION TO PARASITOLOGY

1. Origin of parasitism. Criteria of parasitism.

According to E. N. Pavlovsky, «parasites are animals that live at the cost of individuals of other species, being biologically and ecologically closely connected with them in their life cycle at its longer or shorter duration».

Criteria of parasitism:

- 1) special relations with the host;
- 2) feeding at cost of the host;
- 3) pathogenic action on the host (inflicted harm).

The host of the parasite is an organism that provides it with inhabitation and food and suffers a definite harm from it.

A specific habitation is characteristic of the parasite. The habitation of the 1st order is the host's organism. This environment actively reacts to the presence of a parasite. The habitation of the 2nd order is an external environment. The host is a link between the parasite and the environment.

Parasitism is a most common form of symbiosis. Parasites are all viruses, many bacteria, some kinds of mushrooms and higher plants. 10 000 species of protists, 7000 species of arthropoda, 20 000 species of helminthes are referred to parasites. Some classes are presented completely by parasites — Cryptogamers, Suckers and Tapeworms.

Diseases caused by viruses and bacteria are infections (the flue, hepatitis, tuberculosis, etc.). Protists and helminthes cause invasions (ascariasis, teniasis, enterobiasis, etc.). Diseases caused by arthropoda (ticks and insects) are infestations (pediculosis, myiasis, scabby, etc.).

Age of parasitism: Theoretically, one can presume that parasites appeared simultaneously with protists, because parasitizing bacteria were revealed in the body of amoeba. Multicellular parasites existed already in the paleozoic era. Imprints of sea lilies (echinodermata), the stems of which had gall-like growths caused by nematodes, prove it.

Parasitism origin:

1. **Predator** → **ectoparasite**. Medicinal leeches are temporal ectoparasites for the human, for small animals it may be a predator, as it sucks out a great amount of blood and the animal dies.

2. **Free way of life** → **attached way of life** → **ectoparasitism**. Independently living cirripedia may pass to an attached way of life fixing themselves to underwater parts of wooden buildings or bottoms of ships. They pass to ectoparasitism if they attach themselves to living objects — mollusks' shells or fish bodies.

3. **Commensalism** → **ectoparasitism**. **Commensalism** → **endoparasitism**. If a commensal settles on coverings of its partner's body, it may become an ectoparasite. It becomes an endoparasite, when gets inside the organism in body

cavities connected with an external environment. The enteric amoeba is an endocommensal in the human organism.

4. **Transit through the digestive tract** (larva of a filth fly).

Parasitism is an ecological event. **Ecological Parasitology** studies interrelations of parasites and their populations with each other, with the host organism and the environment.

The «parasite–host» system. This system includes one individual of the host and one or a group of parasites of a definite species.

For the formation of this system, the following conditions are necessary:

- a) a contact between the parasite and the host;
- b) providing conditions for the development of the parasite by the host;
- c) the ability of the parasite to withstand the host's reactions.

The basic direction of evolution is to achieve the equilibrium, smoothing the antagonism between partners and improving the reliability of the system.

Smoothing of the antagonism is achieved due to co-adaptation:

- in the parasite — morphologic and biologic adaptations;
- in the host — complication of defense mechanisms.

Directions of evolution are also different (co-evolution):

- in the parasite — complication of adaptation mechanisms to the host;
- in the host — improving defense reactions at all levels (for destroying the parasite).

Parasitic diseases (parasitism): *protozoosis* (causative agents are protists); *helminthosis* (causative agents are helminthes); *acaraiasis* (causative agents are ticks); *insectosis* (causative agents are insects).

Transmissible diseases — causative agents are transmitted through the blood by a carrier — an arthropod (ticks and insects).

2. **Classification of parasites and their hosts.**

Classification of parasites:

1. According to relation with the host:

- *true* — a parasitic way of life is a species character (ascarids, lice);
- *false* (pseudo-parasites) — free living, but when they get into a living organism, they may exist there and produce harm (larvae of the filth fly);
- *hyper-parasites* or *super-parasites* — are parasites of parasites (bacteria in parasitizing protists).

2. According to localization in the host:

- ectoparasites inhabit body coverings of the host (lice, fleas);
- endoparasites live inside the host's organism:
 - a) intracellular (toxoplasm);
 - b) intracavitary (ascarids);
 - c) tissue (liver sucker);
 - d) intradermal (scabby tick).

3. According to duration of the relation with the host:
 - constant — they spend the whole life cycle in the host (an ascarids);
 - temporal — they spend a part of their life cycle in the host: larval parasitism (larvae of the horse fly); immarginal parasitism — sexually mature individuals parasitize (mosquitoes, fleas).

Classification of hosts:

1. According the parasite's development stage:
 - a) *definitive or final* — the parasite reaches its sexual maturation and undergoes its sexual reproduction in his organism (the human for tenias);
 - b) *alternate or intermediate* — parasite's larvae inhabit his organism, here their asexual reproduction occurs (the human for malaria plasmodia);
 - c) *supplementary or secondary* (predatory fish for larvae of Diphyllbothrium).
2. According to the parasite's development conditions:
 - a) *obligatory or natural* — they provide optimal conditions for parasite development in the presence of biocenotic links (natural ways of infection) — the human for the ascarids;
 - b) *optional or permissive* — the presence of biocenotic links, but the absence of biochemical conditions for the parasite's development (the human for the pig's ascarids);
 - c) *potential* — the presence of biochemical conditions for the development but the absence of biocenotic links (Guiney pig for trichinella).

3. Ways of infecting the human with parasites.

Permeation ways into the host organism:

- 1) *alimentary* — with food and water orally (helminthes eggs, protists cysts);
- 2) *air-drop (respiratory)* — through the respiratory tract (cysts of soil amoebas, some viruses and bacteria);
- 3) *percutant* — through the intact skin (larvae of suckers);
- 4) *transplacental* — intrauterally from mother to fetus (toxoplasma, malaria plasmodia);
- 5) *transfusional* — in transfusion of infected blood (trypanosomes, malaria plasmodia);
- 6) *contact-household* — in contact with a sick person or animal, through utensils (scabby tick);
- 7) *transmissive* — with participation of an arthropod (trypanosomes, malaria plasmodia);
- 8) *sexual* — in sexual contacts (vaginal trichomonade).

Morphophysiological adaptations of parasites. Parasites are highly specialized organisms, maximally adapted to their inhabitation:

- a) **progressive:**
 - *enlargement of body sizes* (up to 20 m in tape worms);
 - *the sexual system reaches its most development* as compared to others;

- *hermaphroditism*;
- *diversity of fixation organs* (sucking discs of lamblia, suckers of sucking insects, botria, hooks of tape worms; claws of lice, etc);
- *external coverings* — tegument, cuticle protect from the action of host's enzymes;
- «*molecular mimicry*» — similarity of proteins of the parasite and the host;

- *excretion of anti-enzymes, histolysines*, by parasites;

b) regressive:

- *simplification of sense organs* — endoparasites have only tactile organs and chemical senses;
- *simplification of the organ system structure* — absence of the alimentary tract in tape worms.

Biological adaptations are associated with peculiarities of the sexual system structure, reproduction and development cycles of parasites:

- a) *high fertility* (*Taenia solium* excretes 100 thousand eggs with every mature segment, an ascarid — 250 thousand eggs per day);
- b) *various forms of asexual reproduction* (Schizogony in malaria plasmodia, polyembryony in suckers);
- c) *migrations over the host organism* (*larvae of taenia solium and ascarids*);
- d) *complex development cycles* with changing of hosts.

The «results» of interactions of the parasite and the host on an organism level may be different: *death of a parasite, death of a host and pathogenicity*.

4. Pathogenic action and specificity of parasites.

Pathogenicity is the ability to cause a disease, it depends on:

- *parasite's genotype*, its species;
- *host's age* (children and old people are more vulnerable to infection);
- *diet regimen* (improper diet increases the number of parasites in the organism and their sizes, reduces the terms of their development);
- *dose and degree of invasion* (the more eggs or larva are introduced into the organism, the more severe will be a course of the disease);
- *resistance degree of the host's organism*;
- *presence of other parasites and diseases*.

Specificity is manifestation of a historically formed adaptation degree of the parasite to the host. Specificity is manifested in the following forms:

- a) *hostal* (that of a host's): monohostal — the parasite has one species of the host (ascarids), polyhostal — the parasite has hosts of various species (*trichinella*);
- b) *topical* (a site of parasitizing): ascarids (intestines);
- c) *age enterobiasis* in children);
- d) *seasonal* (outbursts of amoebic dysentery — the end of spring – summer).

Pathogenic action of parasites:

1. *Mechanic action*: parasites produce it by their body mass (a ball of ascarids in the intestines, an echinococcus vesicle in the brain), by fixation organs (incarceration of the intestinal mucous membrane by suckers), impairment of the skin coverings integrity, etc. This action is revealed due to a pain syndrome.

2. *Toxic-allergic action*: is produced by metabolites of parasites that are antigens; histolyzins and decay products of dead parasites. Manifestations of this action: skin eruptions, dermatitis, eosinophilia, allergic reactions.

3. *Absorption of nutrients and vitamins* in the host's organism results in avitaminosis (mainly A and C), loss of weight, exhaustion.

4. *Impairment of the metabolic process* in the host's organism reduces resistance and increases sensitivity to pathogens of other diseases.

5. Biologically active substances produce an *immune-depressive action*.

6. Some *parasites stimulate* the formation of malignant tumors: schistosomes — cancer of the bladder and rectum.

7. Parasites produce an *unfavorable effect on the course of pregnancy and fetus development* (malaria plasmodia, toxoplasma, cat's sucker, etc.).

5. Host's response to parasitic invasion.

The basis of all reactions — is the host's immune defense. Allergy is a kind of immune reactivity. *The first reaction to a parasite* — is an attempt to kill it with enzymes, then — to neutralize factors of its «aggression» by proteases, inhibitors of enzymes.

Reactions on a cellular level: hypertrophy and modification of the shape of affected cells (erythrocytes in malaria).

Tissue defense reactions: isolation of the parasite from a healthy tissue — the formation of a capsule in trichinellosis, formation of pseudocysts of toxoplasms.

On an organism level: humoral reactions (production of anti-bodies) and various forms of immunity: absolute — relative, active — passive, congenital — acquired.

6. Biological prophylaxis bases of parasitic diseases.

K. I. Skriabin developed **biological prophylaxis bases** for fighting against parasites. It is «a complex of prophylactic measures based on detailed studying of the pathogen's biology, migration ways, stages of its development, biology of intermediate hosts. All these give a possibility to interrupt any link of the parasite development cycle». The final practical aim of Parasitology is protection of the human, animals and plants from parasites' action and elimination of parasitic diseases.

Basic terms and concepts:

1. **Anthroponoses** — are diseases, pathogens of which are transmitted from a human to human.

2. **Invasive diseases** — are diseases caused by protists and helminthes.
3. **Infectious diseases** — are diseases caused by viruses and bacteria.
4. **Hyper-parasitism** — is parasitizing of parasites on parasites.
5. **Zoonoses** — are diseases, pathogens of which are transmitted from an animal to animal, sometimes they may affect the humans too.
6. **True parasites** — this style of life is characteristic of all representatives of this species.
7. **Criteria of parasitism** — basic characteristics of parasitism.
8. **Pathogenicity** — is the ability of the parasite to cause a disease.
9. **Parasite** — is an organism living at the cost of a host and inflicting harm to him.
10. **Parasitism** — is an antagonistic symbiosis, when the parasite used the host as a source of food and environment and does harm to him.
11. **Specificity of the parasite** — a historically formed adaptation degree of the parasite to its host.
12. **Invasive stage** — a stage, when the parasite, having got into the host, continues its development.

PHYLUM SARCOMASTIGOPHORA, CLASSES SARCODINA, ZOOMASTIGOTA

1. General characteristic of the Protist kingdom.

Inhabitanace: water pools, damp soil, organisms of plants, animals and humans. Over 10 000 of 65 000 species are parasites.

A cell of protists performs functions of the whole organism. The membrane consists of a *plasmatic membrane*, elastic membrane — *pellicle* or a denser *cuticle*. The shape is constant (zoomasticota and infusorians) or changeable (sarcodina). The sizes are from 3 to 150 μm . There are 2 layers in the cytoplasm: *ectoplasm* — an external layer and *endoplasm* — an internal one. There are organoids of general purpose (mitochondria, EPR, ribosomes, Golgi's complex, etc.) and of special purpose (pulsing and digestive vacuoles, cilia, filaments, etc.). *Organoids of movement*: pseudopodia (pseudostems), filaments and cilia.

The majority of protists are *heterotrophers*. Substances come by endocytosis, an active transport, osmotically or through a cellular mouth. Around a food particle a *digestive vacuole* is formed and lyzosomal enzymes come there. Digested substances are absorbed by the cytoplasm, and undigested remains are removed from the cell through a plasmolemma in any part of it or through a special opening — cytoproct. Protists have *contractive vacuoles* performing osmoregulation and excretion of dissimilation products, they also stimulate gas exchange.

Cells of protists contain one or several *nuclei*. Reproduction is asexual: division into two or schizogony. There is a sexual process (conjugation or copulation). In unfavorable conditions *cysts* are formed. When they get in favorable conditions excysting and formation of a vegetative form (trophozoit) occurs. *Irritability* has a form of taxis.

Classification: phylum Sarcomastigophora (classes Sarcodina and Zoomastigota), phylum Apicomplexa (class Sporozoa) and phylum Infusoria (class Ciliata).

2. Parasitic Sarcodina (phylum Sarcomastigophora, class Sarcodina).

10 000 species of Sarcodina are the most primitive representatives of Sarcomastigophora. The cellular membrane consists of a cytoplasmic membrane, no pellicle, the body shape is changeable. The cell contains one nucleus. Pseudostems are organoids of movement. In unfavorable conditions cysts are formed. Organoids in parasitic forms are poorly developed. Nutrition is accomplished by endocytosis (bacteria, organic substances, enteric cells, erythrocytes).

Dysentery amoeba, *Entamoeba histolytica* — a pathogen of amoebiasis (amoebic dysentery). The disease is common everywhere, more often in countries with a hot climate.

Morphological peculiarities: 2 stages — a vegetative (trophozoit) and a cyst. Cysts (8–16 μm in size) contain 4 nuclei (fig. 18).

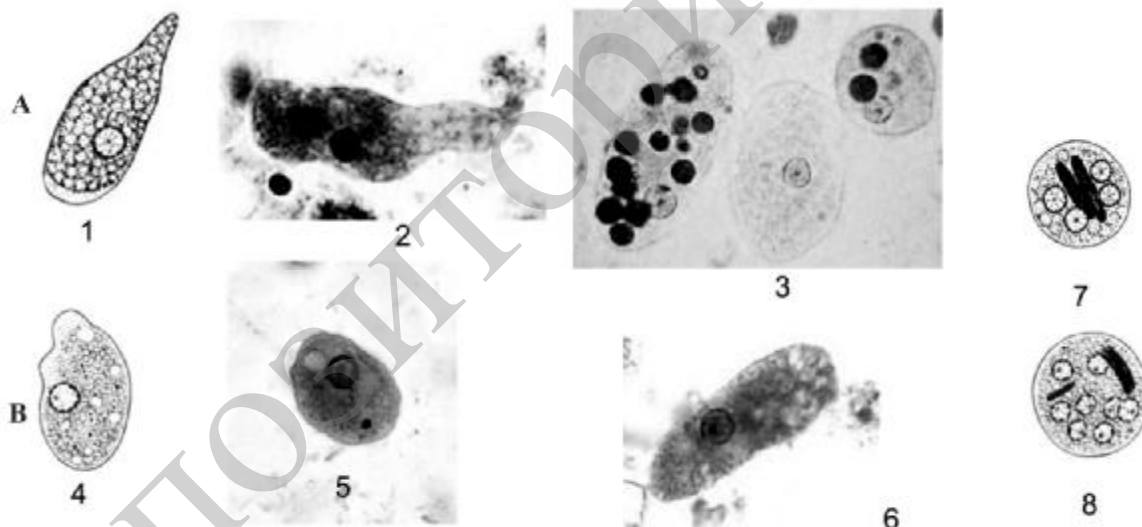

Fig. 18. Morphology of vegetative forms and cysts *E. histolytica* and *E. coli*: *A* — *E. histolytica*, *B* — *E. coli*: 1, 4 — sketches of trophozoits; 2, 5, 6 — trophozoits (7×40); 3 — f. magna with swallowed erythrocytes (7×40); 7, 8 — cysts (7×40)

Trophozoits exist in 3 forms: a small vegetative (*forma minuta*), great vegetative (*forma magna*) and that of tissue. Small vegetative forms (12–20 μm in diameter) are capable of moving, feed on bacteria, are not pathogenic. *Forma magna* (with sizes of 30–40 μm) swallows erythrocytes, excretes proteolytic enzymes. A tissue form (sizes of 20–25 μm) can move fast. A great vegetative and tissue form is pathogenic.

Life cycle: infection of the human occurs alimentally on swallowing cysts. Factors of transmitting cysts: contaminated vegetables, fruit and water. Mechanical carriers of cysts are flies and cockroaches. 4 small vegetative forms develop from a cyst in the intestinal lumen. They can exist for a long time (eat, multiply) and transform into cysts (cystic pathogenicity) (fig. 19).

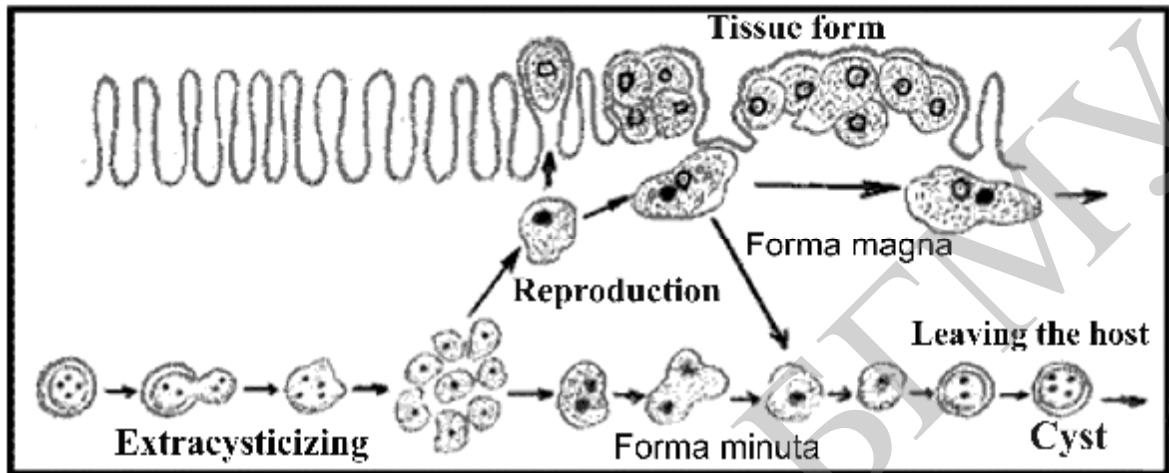

Fig. 19. Life cycle of a dysentery amoeba. (*Entamoeba histolytica*)

When the host's organism is weakened (by suffered infections, using spicy food, fasting, hyperthermia, etc.) forma minuta passes into forma magna that destroys the mucous membrane epithelium of a large intestine. In the intestinal wall this form transforms into a tissue form, it may get into the liver, brain and other organs through vessels. In remission, pathogenic forms in the intestinal lumen transform into small vegetative forms and then into cysts.

Pathogenic action:

1. *Mechanic* (destruction of the large intestine mucous membrane with formation of bleeding ulcers from some mm to 2–2,5 cm in diameter).
2. **Toxic-allergic** (poisoning by waste products).
3. *Feeding on the host's organism and impairment of metabolic processes* (absorption of erythrocytes and vitamins, impairment of water-salt exchange).

Characteristic symptoms: bloody diarrhea up to 10 times a day and more, pains in the abdomen in the large intestine area (the right hypochondrium). Intoxication may be marked in various degrees.

Complication of amebiasis: amoebic processes in the liver and lungs, suppurative peritonitis, inflammatory processes of the skin in the perineal area.

Laboratory diagnosis: microscopic investigation of feces smears, the content of ulcers bottom and revealing a tissue and a large vegetative form in it. It is possible to reveal cysts during remissions and cystic pathogenicity.

Prophylaxis: personal — observing hygienic rules (washing hands and vegetables, fruit with hot water, protection of food from flies and cockroaches). Social prophylaxis: revealing and treating sick persons; control over the sanitary

condition of water wells, food enterprises, shops and markets; prophylactic examination of workers of catering enterprises; killing flies and cockroaches; sanitary-popularization activity.

Intestinal amoeba, *Entamoeba coli* is similar in morphology with a dysenteric amoeba. Its localization is in the lumen of a large intestine of the human. It forms trophozoites and cysts. Mature cysts of an intestinal amoeba (its sizes are 13–25 μm) contain 8 nuclei. Trophozoites do not excrete proteolytic enzymes and do not injure the intestinal wall. It is not pathogenic.

Oral amoeba, *Entamoeba gingivalis* occurs in carious teeth and in dental deposits, on palatal tonsils. The body size is from 6 to 30 μm . It feeds on bacteria and leukocytes, sometimes erythrocytes. It does not form any cysts. The pathogenic action is not revealed.

3. Amoebas of *Limax* group.

They are free living amoebas inhabiting water reservoirs and soil. Having got into the human organism they are capable to cause severe inflammatory processes in CNS (meningoencephalitis). The most dangerous are representatives of two genera: *Naegleria* and *Acanthamoeba* (fig. 20).

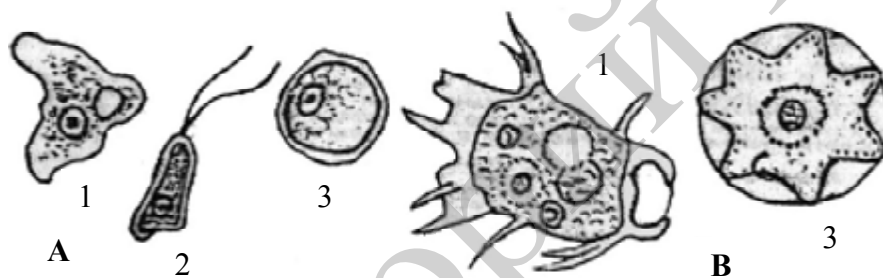

Fig. 20. Amoebas of *Limax* group:

A — *Naegleria*, B — *Acanthamoeba*: 1 — an amoebic stage; 2 — a filament stage; 3 — a cyst

Morphological peculiarities: vegetative forms of g. *Naegleria* (20–30 μm in size) have short broad pseudopodia (am amoebic stage). In sharp changes of temperature amoebas form 2 filaments (a filament stage) and pass to active motion. Representatives of g. *Acanthamoeba* have no filament stage. Amoebic stages have multiple narrow sharpened pseudopodia. Cysts may not form in tissues.

Life cycle: amoebas of *Limax* group may parasitize on the human, apes and rodents. The most virulent is *Naegleria*. Infection occurs through the mucous membrane of the nasopharynx while bathing in open water reservoirs and swimming pools, through water while washing up (*Naegleria*), by cysts with dust (*Acanthamoeba*). From the nasal cavity amoebas permeate into the brain along an olfactory nerve.

Pathogenic action:

1. *Mechanic* (destroys the cortical grey matter of the cerebral hemispheres and its membrane).

2. *Toxic-allergic* (poisoning by waste products).

Due to the integrity impairment of cells and cerebral membranes the inflammatory process develops.

Clinical manifestations. *The incubation period lasts 4–7 days.* A running nose, malaise, conjunctivitis, cough, elevation of temperature. Then appear symptoms of affecting cerebral membranes and the brain substance (high temperature, vomiting, loss of consciousness, etc.), in the absence of treatment death occurs in 3–5 days.

Laboratory diagnosis: revealing vegetative forms in the cerebrospinal fluid (liquor).

Prophylaxis: not to bathe in open water reservoirs, sanitary control over the water condition, sanitary-popularization activity.

4. Parasitizing filamentous protists (phylum Sarcomastigophora, class Zoomastigota).

There are 8 000 species of Sarcomastigophora. Many representatives are parasites of animals and humans. They have a constant body shape (they have pellicules). Contain one nucleus. Organoids of movement *filaments and an undulating membrane*, representing a cytoplasmatic protuberance. Parasitic species — heterotrophs, the way of feeding — osmotic. They multiply by a longitudinal division into two. Some species have a sexual process — *copulation*.

Leishmania. Leishmaniasis — a natural-focal disease. Visceral leishmaniasis is common in the area of the Mediterranean Sea, Middle and South Asia, Africa and South America. American leishmaniasis occurs in South Europe, North and West Africa, Near East, Central and South Asia. The focus of mucocutaneous leishmaniasis is in South and Central America.

Morphological peculiarities: there are 2 forms — a promastigota (a non-filament rounded or an oval form, 3–5 μm in size). Leishmaniasis pathogens are morphologically similar but have biochemical and antigenic differences (fig. 21).

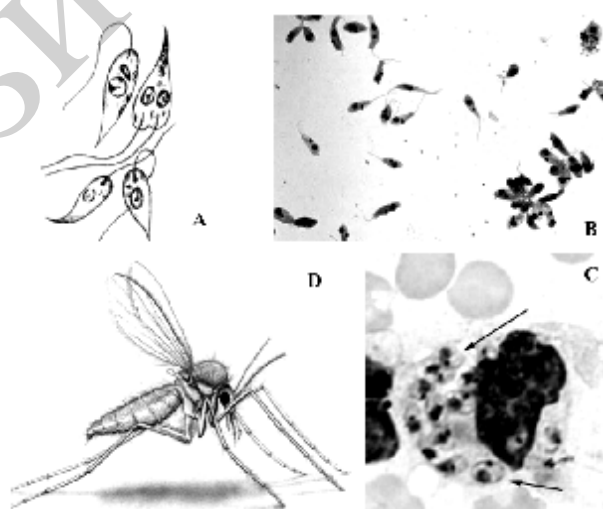

Fig. 21. Morphology of leishmaniasis pathogens and their transmitter: A — a sketch; B — a filament form (7×40); C — a non-filament form inside the macrophage (7×40); D — a mosquito

Life cycle: specific transmitters — mosquitoes of g. *Phlebotomus* that have a filament stage — promastigota (fig. 22).

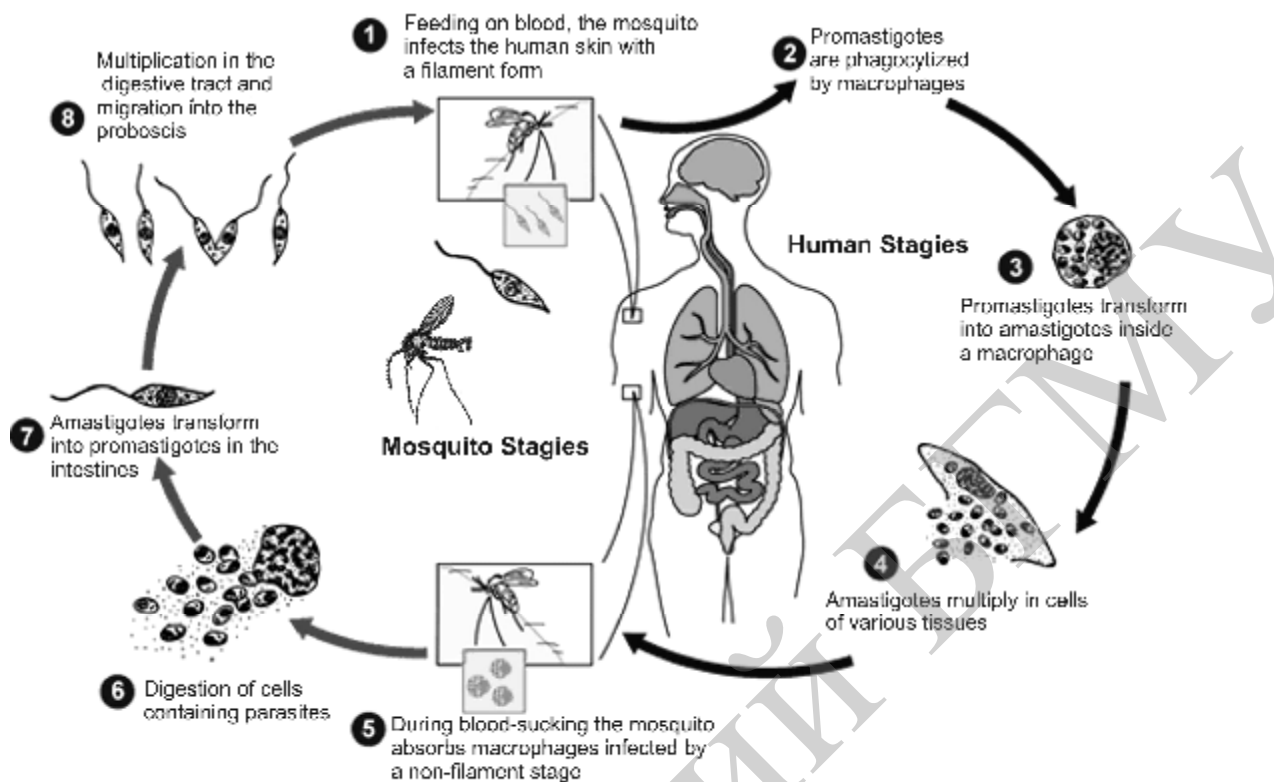

Fig. 22. Life cycle of leishmaniasis pathogens

Infecting of the human occurs in mosquito bites (a transmissible way). *Leishmania* lose their filament in the human organism, transform into amastigotes, pass to intracellular parasitizing and intensively multiply.

Natural reservoirs of *L. donovani* may be coyotes, dogs, rodents, of *L. tropica* — rodents, of *L. braziliensis* — rodents, apes and sloths. *L. donovani* and *L. infantum* cause visceral leishmaniasis, dum dum fever, visceral leishmaniasis, infantile leishmaniasis.

Pathogenic action:

1. *Mechanic* (destruction of hepatic cells, lymphatic nodes, red marrow).
2. *Toxic-allergic* (poisoning by waste products). Incubation period — from several weeks to 6–8 months.

L. donovani and *L. infantum* are called visceral leishmaniasis (black disease, dum dum fever, kala-azar, infantile leishmaniasis).

Characteristic symptoms: irregular fever, weakness, headache, exhaustion, rash, enlargement of the liver and spleen, anemia.

Children fall ill more often.

After leishmaniasis they acquire a persistent immunity.

Laboratory diagnosis: revealing leishmania in punctuates of red marrow (breastbone), lymphatic nodes.

L. tropica major and *L. tropica* minor cause cutaneous leishmaniasis (oriental ulcer).

Pathogenic action:

1. *Mechanic* (destruction of cutaneous cells).
2. *Toxic-allergic* (poisoning by waste products).

Characteristic symptoms: Small erythematic protuberances on the skin in 2–6 weeks after a mosquito bite. Later on forms an ulcer with elevated edges (leishmanioma). The whole process from the first manifestations to healing of the ulcer takes from 3–4 months to 2 years. After healing of ulcers ugly scars stay.

Laboratory diagnosis: revealing leishmania in smears from ulcers content.

L. brasiliensis, *L. mexicana* and *L. peruviana* cause **cutanomucous leishmaniasis** (espundia).

Pathogenic action:

1. *Mechanic* (cell destruction of the skin, mucous membranes, cartilages).
2. *Toxic-allergic* (poisoning by waste products).

Incubation period from 2–3 weeks to 1–3 months.

Characteristic symptoms: Ulcers gradually destroying all soft tissues. Overgrowing of the tissues of the nose, lips, pharynx, larynx. The disease is difficult to treat and it often ends with death.

Laboratory diagnosis: revealing leishmania in smears from the ulcers content.

Prophylaxis: protection from mosquito bites (repellents, nets against mosquitoes) and vaccination, revealing and treating sick persons, killing mosquitoes and animals-reservoirs of the diseases, sanitary-popularization activity.

Trypanosomes. Pathogens of African sleeping disease (African trypanosomiasis) are *Trypanosoma brucei gambiense* (West Africa) and *Trypanosoma brucei rhodesiense* (East Africa). American trypanosomiasis (Chagas' disease) caused by *Trypanosoma cruzi* is spread in South America. They are transmissible diseases with a natural focal origin.

There are the following stages in the development cycle of trypanosomes (fig. 23):

– a *trypomastigote* has an elongated shape, a long filament, an undulating membrane; it parasitizes on the organism of vertebrate hosts (the human, animals) and is an invasion stage for them;

– an *epimastigote* resembles a trypomastigote, but its filament is shorter and an undulating membrane is poorly expressed; it exists only in the organism of the transmitter and can transform into a trypomastigote;

– an *amastigote* is immobile, parasitizes on the organism of vertebrate hosts, it is an intracellular parasite; can transform into a trypomastigote.

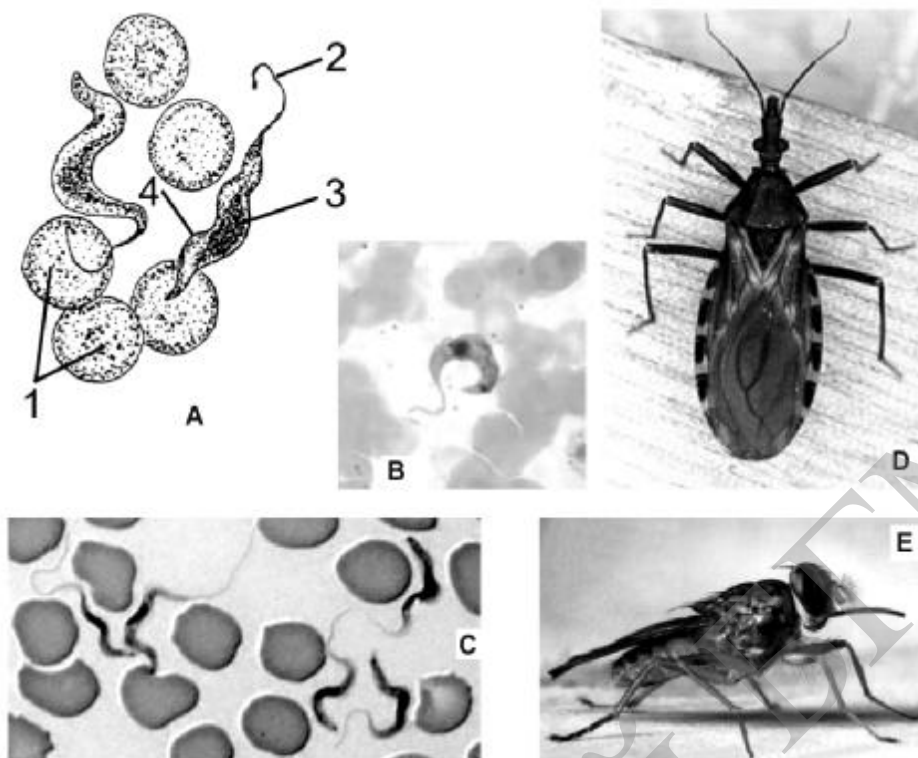

Fig. 23. Morphological peculiarities of pathogens of African trypanosomiasis: A — a sketch: 1 — erythrocytes; 2 — a filament; 3 — a nucleus; 4 — an undulating membrane; B — *T. cruzi* (7×40); C — *T. brucei* (7×40); D — *Triatoma infestans*; E — *Glossina palpalis*

The body is curved, has a filament going along the edge of an undulating membrane. The body length is 13–40 μm . They feed osmotically, multiply by division into two.

Life cycle: 2 stages of the development: a trypomastigote and an epimastigote (fig. 24). Tsetse flies (g. *Glossina*) are specific transmitters. When the fly sucks blood of a sick person, trypomastigotes get into its stomach. Here they transform into epimastigotes, multiply and accumulate in salivary glands (the development duration is 20 days). When healthy people are bitten by flies (a transmissible way), infection occurs. Infection is possible in blood transfusion and while using unsterilized syringes. A transplacental way is possible.

The second part of the cycle undergoes in the organism of the human and reservoir hosts (for a gambiense trypanosome — pigs, for a rhodesiense one — antelopes and the cattle). At first trypomastigotes inhabit the hypodermal cellular tissue, then the lymphatic system, they multiply and in 20–25 days enter the blood and are carried to all tissues and organs. The predominant localization — the cerebrospinal fluid, then they get into the brain and spinal cord.

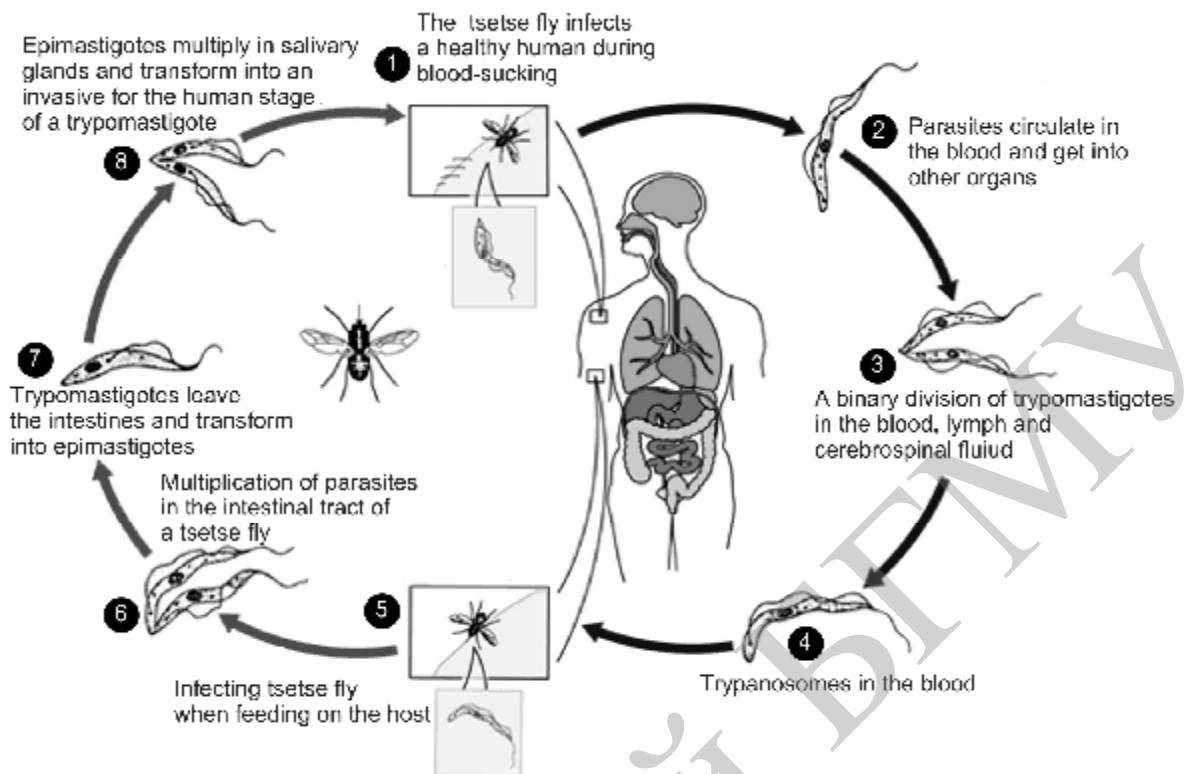

Fig. 24. Life cycle of pathogens of African trypanosomiasis

Pathogenic action:

1. *Mechanic* (destruction of cells and tissues of affected organs).
2. *Toxic-allergic* (poisoning by waste products).

Incubation period is from 1–3 weeks to 2 and more years.

Characteristic symptoms: a tryposomal chancre at a bite site, enlargement of lymphatic nodes on the back surface of the neck, elevation of temperature, weakness, exhaustion. Later symptoms of the CNS affection appear: sleepiness, progressing imbecility, soporose (inhibited); and then a comatose state (loss of consciousness). In gambiense variant a progressing encephalitis is noted, it is characterized by sleepiness (a sleeping disease). In the absence of treatment a fatal outcome is observed.

Laboratory diagnosis: revealing trypanosomes in smears of peripheral blood, punctuates from lymphatic nodes, cerebrospinal fluid; immunological reactions (determination of anti-bodies in the blood serum of patients).

Prophylaxis: protection from bites of the tsetse fly, revealing and treatment of sick persons and parasitic pathogens, sanitary popularization activity.

Morphological peculiarities of a pathogen of **American trypanosomiasis** are similar to that of African trypanosomiasis.

Life cycle: The pathogen of Chagas' disease parasitizes on the human and animals (armadillos, ants, etc.) that are natural reservoirs of pathogens. Specific transmitters are kissing bugs of g. *Triatoma*. In sucking the blood of a sick per-

son or animals trypomastigotes get into the intestine of bugs, transform into epimastigotes, multiply, transform into trypomastigotes and some time later are excreted with their excrements. Infecting of the human (a transmissible way) occurs, when excrements with pathogens get on the injured skin (wounds from bites, scratches). Infecting is also possible in transfusing blood, transplacentally. In the human organism trypomastigotes transform into amastigotes and multiply. In 1–2 weeks amastigotes transform into trypomastigotes inside the injured cells and enter the blood flow, circulate throughout the organism, invade the cells (of the cardio-vascular and skeletal musculature, nervous system, etc.), where the cycle repeats.

Pathogenic action:

1. *Mechanic* (destruction of cells and tissues of organs, tissue edema).
2. *Toxic-allergic* (poisoning by waste products).

Incubation period lasts 4–14 days.

Characteristic symptoms: at the site of trypanosomes permeation into the skin appears hyperemia and edema (chagoma). In 1–2 weeks (when parasites enter the blood) appears fever, headache, face edema, pains in the heart area and signs of cardiac insufficiency. Complications: meningoencephalitis, impairment of the vegetative nervous system, the heart, liver, kidneys and other organs; the mortality reaches 14 %.

Laboratory diagnosis: revealing trypanosomes in blood smears, cerebrospinal fluid, punctuates from lymphatic nodes, spinal cord; immunological reactions (revealing anti-bodies in the blood serum of sick persons).

Prophylaxis: revealing and treating sick persons, killing and protection from bites of kissing bugs (repellents, etc.), sanitary popularization activity.

Lambliia. Lambliia (Giardia) intestinealis — a pathogen of lamblia. Parasitizes only on the human. The disease is spread everywhere.

Morphological peculiarities: a pear-like shape (fig. 25), the body size is 10–18 μm . 4 pairs of filaments, 2 supporting cores (axostyles) dividing the body into two symmetrical halves having per 1 nucleus and a sucking disc. Cysts have an oval shape.

Life cycle: 2 stages: a vegetative (a trophozoit) and a cyst. Infecting occurs by an alimentary way, when cysts are swallowed with unwashed vegetables and fruit, with water. Excysting occurs in the duodenum. Localization — the upper part of a small intestine and bile ducts.

Pathogenic action.

1. *Mechanic* (irritation of the duodenum mucous membrane, impairment of wall digestion and absorption).
2. *Toxic-allergic* (poisoning by waste products).
3. *Feeding on the host organism and impairment of metabolic processes* (absorption of nutrients and vitamins).

Characteristic symptoms: general malaise, poor appetite, nausea, pains in the epigastric region and right hypochondrium, unstable stool (diarrhea, constipation). Lambliosis aggravates the course of other diseases of the digestive system.

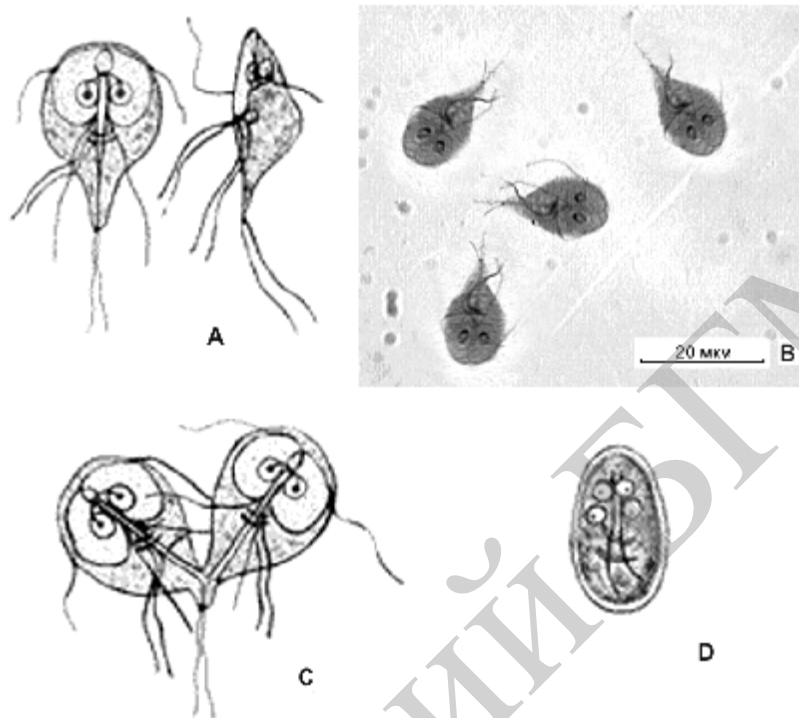

Fig. 25. Morphology of lamblias (*Lamblia intestinalis*):
A — asketch of a trophozoit; *B* — Trtrophozoits (7×40); *C* — division into two; *D* — a cyst

Laboratory diagnosis: revealing vegetative forms (trophozoits) in feces or duodenal content.

Prophylaxis: observing rules of personal hygiene, revealing and treating patients, sanitary popularization activity.

Trichomonas. *Trichomonas vaginalis* — a pathogen of urogenital trichomoniasis. The disease is common everywhere.

Morphological peculiarities (fig. 26): an oval shape with a sharpened long thorn at the back end. Body sizes up to 30 μm . Has 5 filaments. One filament goes along an undulating membrane. A supporting core (axostyle) is in the middle of the body. There is a nucleus and digestive vacuoles in the cytoplasm.

Life cycle: infection occurs in sexual contacts, also through insterile gynecological instruments. Affects urinary ways. Does not form cysts.

Pathogenic action.

1. *Mechanic* (destruction of the urinary mucous membranes).
2. *Toxic-allergic* (poisoning by waste products).

Characteristic symptoms: in acute form — itching, a burning sensation in urogenital ways, a local inflammatory process, plentiful fluid discharge of a greenish color with unpleasant smell.

Laboratory diagnosis: revealing trophozoites in native smears of the content from urogenital ways.

Prophylaxis: revealing and treating sick persons, excluding accidental sexual contacts, observing instruments sterility in examination rooms, sanitary-popularization activity.

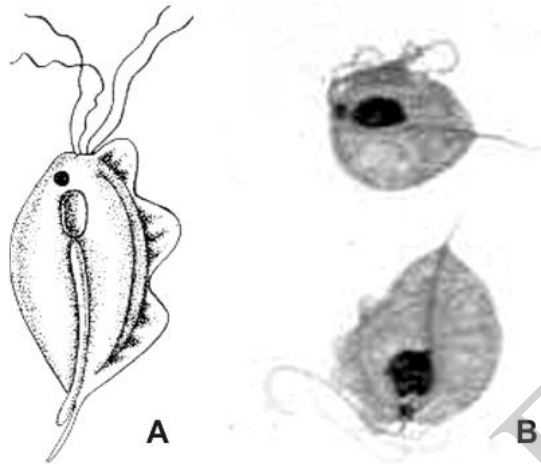

Fig. 26. Trichomonas morphology:
A — a sketch; B — a trophozoit (7×40)

Basic terms and concepts:

1. **Axostyle** — a supporting core, which goes in the middle of a protist cell.
2. **Amoebiasis** — a disease caused by *Entamoeba histolytica*.
3. **Chagas' disease** — a disease caused by *Trypanosoma cruzi*.
4. **Dermato-mucous leishmaniasis** — this disease is caused by *Leishmania brasiliensis*, *Leishmania mexicana* and *Leishmania peruviana*.
5. **Lambliasis** — a disease caused by *Lamblia intestinalis*.
6. **Amoebic meningoencephalitis** — severe inflammatory processes of CNS that may be caused by amoebas of the *Limax* group.
7. **Pellicle** — an elastic membrane covering a protist cell.
8. **Sleeping disease (trypanosomiasis)** — a disease caused by *Trypanosoma brucei*.
9. **Trichomoniasis** — a disease caused by *Trichomonas vaginalis*.
10. **Trophozoit** — a vegetative form of protists.

**PHYLUM INFUSORIA, CLASS CILIATA
PHYLUM APICOMPLEXA, CLASS SPOROZOA**

1. Balantidium.

Balantidium coli — is a human parasite of the Ciliata class, it causes balantidiasis (infusoric dysentery). The disease is common everywhere.

Morphological peculiarities (fig. 27): the body is of oval shape, sizes — 30–150 × 40–70 μm. There is a peristome at the frontal end, which passes into a cystome and a funnel-like cytopharynx. At the back side is cytoproct. The macronucleus has a bean-like or rod-like shape. There are 2 contractive vacuoles. It can form cysts.

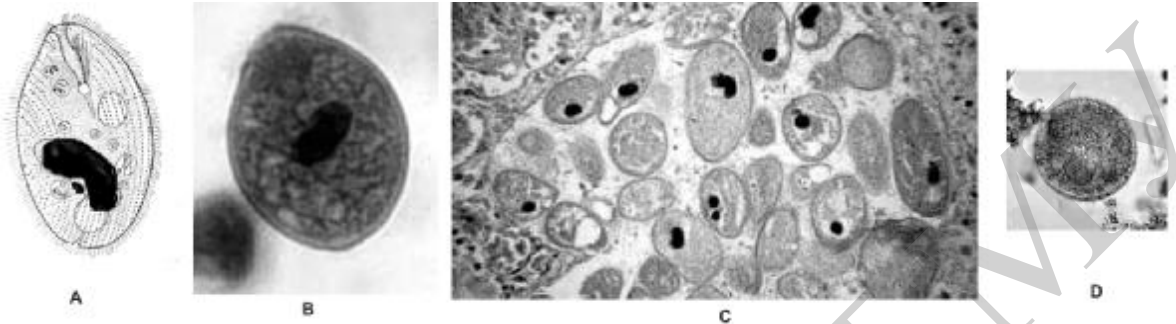

Fig. 27. *Balantidium coli* morphology:

A — a sketch; B — a trophozoite (7×40); C — accumulation of parasites in tissue (7×40); D — a cyst (7×40)

Development cycle: a vegetative form parasitizes in a thick part of the intestines (caecum). Infection occurs alimentally on swallowing cysts (invasive stage) with contaminated vegetables, fruit, drinking water. Workers of pig-breeding farms are affected more often, because pigs are a source of invasion. Trophozoites are formed in the alimentary tract from cysts.

Pathogenic action:

1. *Mechanic* (impairment of the intestinal mucous membrane and formation of deep ulcers).
2. *Toxic-allergic* (poisoning by waste products).
3. *Feeding on the host's organism* (with food particles, sometimes erythrocytes and leukocytes are found in its cytoplasm).

Characteristic symptoms: diarrhea with blood, pains in the abdomen, vomiting, malaise, weakness, headache.

Complications: perforation of ulcers and liver abscesses.

Laboratory diagnosis: revealing vegetative forms of the parasite in feces smears.

Prophylaxis: observing rules of personal hygiene, revealing and treating sick persons. Protection of the environment from contamination by feces of pigs and sick people, sanitary-popularization activity.

2. Life cycle of a human malaria pathogen. Types of malaria plasmodia, their morphological characteristic in a thin blood smear.

Human malaria pathogens (fig. 28) are referred to order of Haemosporidia, genus of Plasmodium.

They are of 4 types:

1. *Plasmodium vivax* — a 3-day malaria pathogen.
2. *Plasmodium ovale* — an ovale malaria pathogen (kind of a 3-day variety).

3. *Plasmodium malariae* — a 4-day malaria pathogen.
4. *Plasmodium falciparum* — a tropic malaria pathogen.

Malaria occurs predominantly in countries with a subtropic and tropic climate.

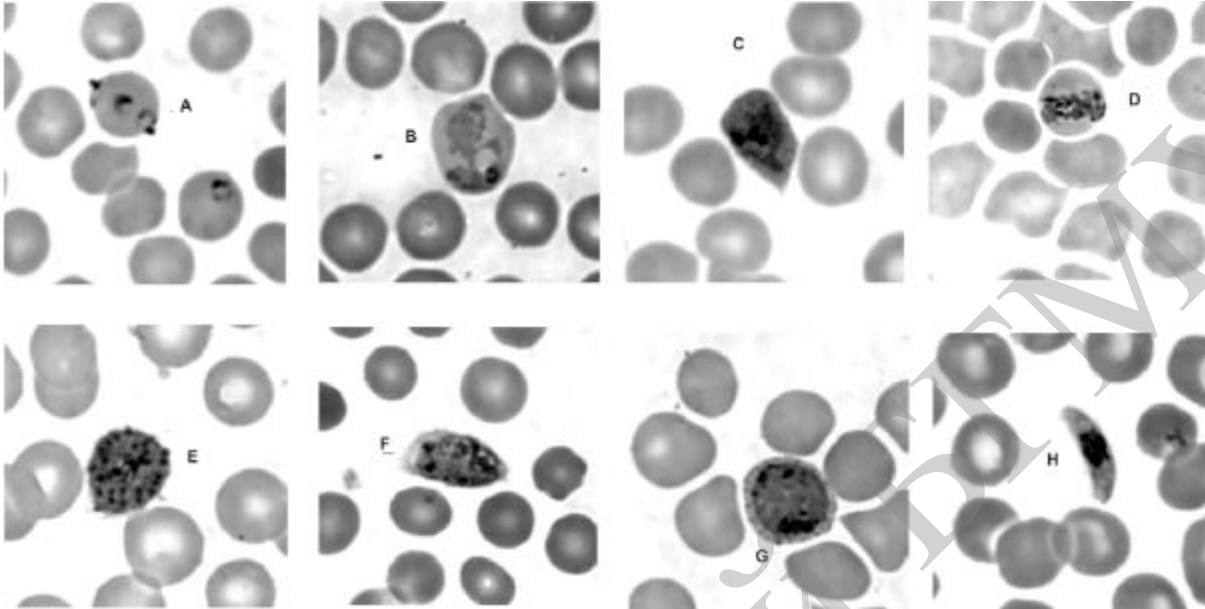

Fig. 28. Malaria pathogens morphology:

A — a ring of *Pl. falciparum*; *B* — an amoeba-like shizont of *Pl. vivax*; *C* — shizont of *Pl. ovale*; *D* — a tape-like shizont of *Pl. malariae*; *E* — morula of *Pl. vivax*; *F* — a morula of *Pl. ovale*; *G* — a gametocyte of *Pl. vivax*; *H* — a gametocyte of *Pl. falciparum*.

Life cycle. The human is an intermediate host for a malaria pathogen, and mosquito females are principal hosts (fig. 29).

Contamination of the human occurs on bite by a female mosquito of *Anopheles* g.; it injects plasmodium *sporozoites* into the blood together with saliva. Sporozoites are carried by the blood flow into cells of the liver, spleen, endothelium of blood capillaries, where they transform into tissue shizonts. Shizonts grow and in 5–16 days schizogony passes and *tissue merozoites* form. All these development stages are called tissue (pre-erythrocytic) schizogony corresponding to an incubation period of the disease.

Tissue merozoites destroy cells, enter the blood and settle in erythrocytes. The cycle of erythrocytic schizogony starts. The merzoit that permeated the erythrocyte, is an *erythrocytic shizont*, undergoes the stages of a ring and amoebic shizont. Their nucleus is divided many times (into 6–24 parts), and segments of the cytoplasm are isolated around the nucleus. Such stage is called a *morula*. The cells formed as a result of erythrocytic schizogony are *blood merozoites*. The erythrocyte membrane destroys, and merozoites and their metabolites enter the blood (*merulation*). And at this moment a malaria attack starts.

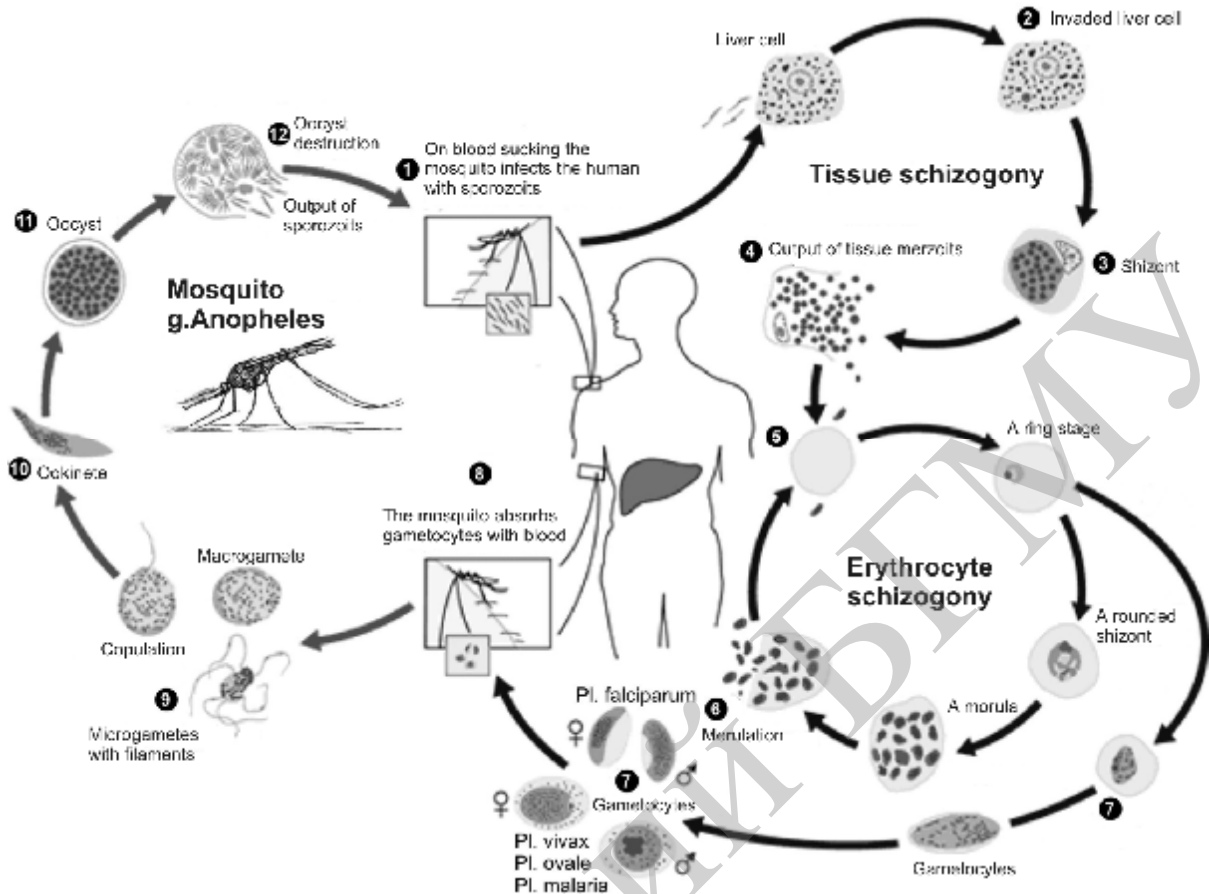

Fig. 29. Life cycle of malaria pathogens

A part of merozoites permeate erythrocytes again and repeat the cycle of erythrocytic schizogony (it may be repeated many times). The other part of merozoites, having got into erythrocytes, transform into *gamonts* (*micro- and macrogametocytes*), further development of which (*gametogony*) occurs in the mosquito body. On getting into the human blood microgametocytes and macrogametocytes get into the mosquito female's stomach, where *micro- and macrogamets* form. They fuse forming a mobile zygote (*ookinete*), which actively implants into the stomach wall, permeates to its surface, covers itself with a protective membrane and transforms into an *oocyst*. The oocyst enlarges in size, its content divides repeatedly and a great number (up to 10 000) of *sporozoites* are formed (*sporogony*). The membrane of a mature oocyst breaks, sporozoites get into a cavity of the mosquito body and are carried to all organs with the hemolymph, accumulating predominantly in salivary glands.

3. Ways of infecting the human with malaria, pathogenic action of pathogens; symptoms and diagnosis of malaria.

Infecting of the human occurs in a bite by a female mosquito p. Anopheles that injects sporozoites of malaria plasmodium into the blood with saliva (a transmission way). Infection is also possible in blood transfusion and trans-

placentally. In this case an invasive stage for the human is an erythrocyte shizont, and such malaria is shizont.

Pathogenic action:

1. *Mechanic* (destruction of erythrocytes and hepatocytes).
2. *Toxic-allergic* (poisoning by waste products).
3. *Feeding on the host* (absorption of hemoglobin) *and impairment of metabolic processes*.

Characteristic symptoms: intermittent fever attacks. An attack lasts 6–12 hours, it has 3 phases: chill, fever and perspiration. The attack starts with chills lasting from 0,5 to 2–3 hours. Then a sharp elevation of temperature up to 40–41 °C is noted. Patients develop a severe fever and intoxication symptoms. In 6–8 hours (in tropical malaria it occurs later) the body temperature suddenly drops to 35–36 °C and a profuse perspiration starts, intoxication decreases, patients feel better. In a 3-day malaria the attacks are repeated in 48 hours, and in a 4-day malaria — in 72 hours. It is due to the fact that the duration of erythrocyte schizogony for *Plasmodium vivax*, *Plasmodium ovale* and *Plasmodium falciparum* is 48 hours, and for *Plasmodium malaria* — 72 hours.

Enlargement of the liver, spleen is observed (here affected erythrocytes are destroyed). The disease is accompanied by anemia.

Tropical malaria has a more severe course and results in lethal outcomes. Basic causes of complications (malaria coma, acute renal insufficiency, etc.): all age forms of erythrocytes are affected; a great number of blood merozoites; erythrocyte schizogony occurs not in large blood vessels, as in other types of plasmodia, but in capillaries of internal organs (the brain).

Laboratory diagnosis: revealing of parasites in the blood (a thick blood smear). It is necessary to take blood during an attack or immediately after it. To determine the species belonging of plasmodia one should pay attention to the following signs:

1. In *Plasmodium vivax* the stage of an amoeba-like shizont is marked.
2. Erythrocytes affected by *Plasmodium ovale* are enlarged and have an irregular shape with torn fringed edges.
3. For *Plasmodium falciparum* the stage of a semi-lunar gamont is characteristic.
4. For *Plasmodium malaria* the stage of a tape-like shizont is characteristic.

Immunological methods are also used for diagnosis (determination of antibodies in the patients' blood).

4. Biological bases of malaria prophylaxis.

Personal prophylaxis: defense from mosquitoes' bites (using repellents) and chemical prophylaxis. **Social** — revealing and treating sick persons and parasites carriers, sanitary-popularization activity, destruction of mosquitoes of g. *Anopheles*.

Fighting mosquitoes includes the following directions:

1. *Immediate defense from mosquitoes' attacks* (wearing covering-up clothes, repellents, setting nets on windows of dwelling houses, zooprophyllaxis — making biologic barriers (cattle-breeding farms) between places of mosquitoes' reproduction and dwelling houses, etc.).

2. *Fighting against winged mosquitoes* — dispersion of insecticides in places of wintering and sleeping of mosquitoes (basements, garrets, cattle yards).

3. *Fighting against larvae:*

a) drainage of small water reservoirs having no economic significance;

b) using toxic chemicals;

c) shading water reservoirs with trees;

d) drainage of mashes, deepening of reservoirs, straightening of riverbeds;

e) dispersion of mineral oils over the surface of water reservoirs; they block stigmas;

f) growing gambusia fish (a biological way).

Toxoplasm. *Toxoplasma gondii* — is a representative of the Sporozoa class, Coccidia order. It is a pathogen of toxoplasmosis. The disease is common everywhere, 30 % of the Earth population are infected.

Morphological peculiarities (fig. 30): a trophozoite has a semi-lunar shape, sizes of 4–7–2–4 μm .

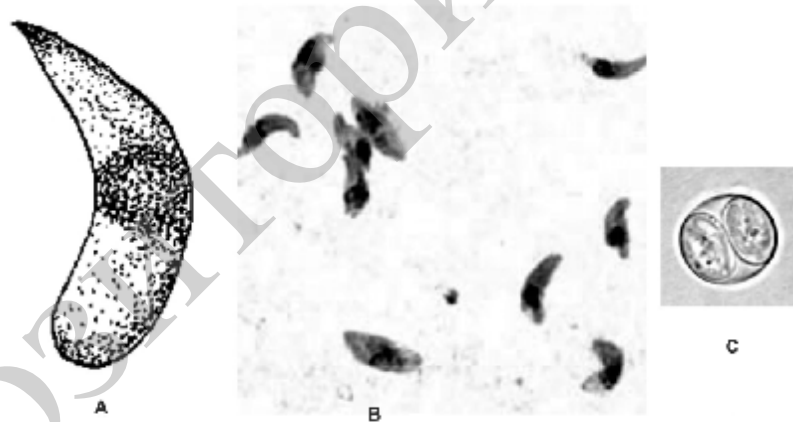

Fig. 30. Morphology of *T. gondii*:

A — a sketch; B — a trophozoite (7 \times 40); C — an oocyst (7 \times 40)

One of its ends is sharpened, the other is rounded. The body is covered with 2 membranes. The nucleus is large. There is a *conoid* on the sharpened end; it serves for attachment of the parasite to a host's cell.

Development cycle: principal hosts — are representatives of the Feline species (cat, lynx, etc.) (fig. 31).

Intermediate hosts — all mammals, birds and reptiles. Invasion sources: 1) cats, excreting oocysts with sporozoites into the environment; 2) wild and domestic animals, birds and humans excreting tissue cysts with trophozoites in sali-

va, nose mucus, sperm, feces and milk; 3) meat of domestic animals and wild animals and birds.

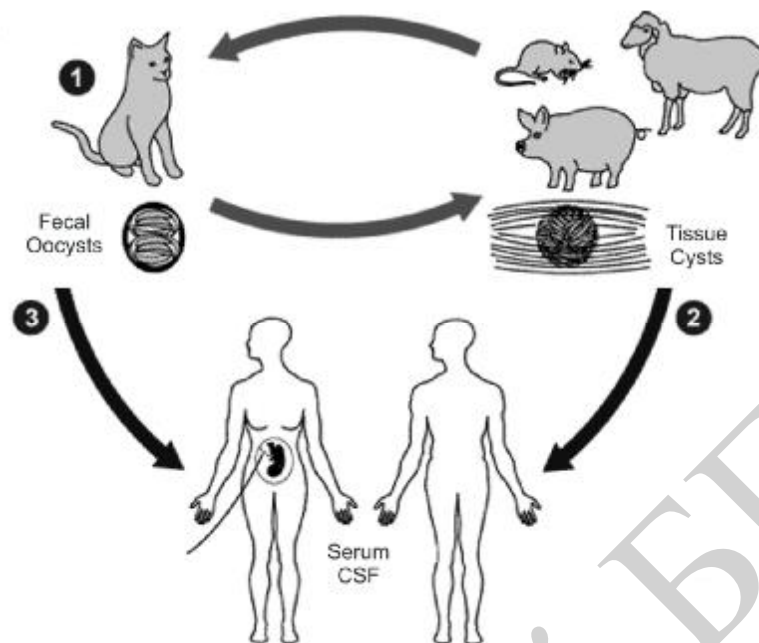

Fig. 31. Life cycle of *T. gondii*

Mechanisms and ways of transmission:

- 1) alimentary — through contaminated food of animal origin (meat, milk and eggs);
- 2) contact — in contact with cats (contamination with oocysts), through the broken skin during processing skins of affected animals;
- 3) transplacental.

Pathogenic action:

1. *Mechanical* (impairment of cells, hemorrhages in serous membranes, necrotic foci in the liver, spleen, brain).
2. *Toxic-allergic* (poisoning by waste products).

Characteristic symptoms. *Acquired toxoplasmosis* has no symptoms. In people with weakened immunity the disease has symptoms of chronic intoxication: prolonged elevation of temperature to 37,3–37,5 °C, weakness, listlessness, poor appetite, headache, worsening of memory, etc., lymphatic glands are enlarged (cervical, occipital, inguinal).

Congenital toxoplasmosis. If infection occurs during the first months of pregnancy, miscarriages or still-birth may be observed. When infection occurs at a later term of pregnancy, the development of the fetus's brain may be impaired (hydrocephaly), meningoencephylitis develops, sometimes — inflammation of ocular membranes, jaundice, enlargement of the liver and spleen.

Laboratory diagnosis: Immune methods (revealing anti-bodies in the blood of sick people). Sometimes one can reveal parasites in blood smears, punctuates of lymphatic nodes and cerebrospinal fluid.

Prophylaxis: personal — observing rules of hygiene after contacts with cats, eating cooked meat, boiled milk, observing rules of cutting and cooking animal carcasses. **Social** — protection of the environment and water sources from contamination by animal feces, sanitary-popularization activity. Timely examination of pregnant women is necessary for prophylaxis of congenital toxoplasmosis.

Basic terms and concepts:

1. **Gametogony** — development of gametes in a female mosquito body.
2. **Gamont (gametocyte)** — an ovule of a malaria plasmodium.
3. **Shizont malaria** — malaria, when the invasive stage is an erythrocyte shizont.
4. **Merozoit** — a vegetative stage in the Sporozoa development cycle.
5. **Merulation** — outcome of merozoites from erythrocytes into the blood plasma.
6. **Ookinete** — a movable zygote of malaria plasmodia.
7. **Oocyst** — a stage formed from an ookinete on an external surface of the female malaria mosquito stomach; it contains sporozoites.
8. **Pseudocyst** — a tissue cyst that is formed as a result of accumulation of trophozoites covered with a cellular membrane.
9. **Shizont** — a life stage of the Sporozoa that is capable of repeated division (*schizogonies*).
10. **True cyst** — is formed as a result of gametes fusion (copulation).

PHYLUM PLATHELMINTHES, CLASS TREMATODA

1. General characteristic and classification of the phylum.

The number of species: 15 000. Style of life: free living and parasites (suckers, tape-like). Characteristic features of the **phylum**: 1) 3-layers (the development of 3 germinal layers); 2) double-sided (bilateral) symmetry of the body; 3) elongated, flattened body; 4) dermato-muscular sac; 5) absence of a body cavity; 6) organ systems: digestive, excretory, nervous and genital.

The dermato-muscular sac consists of a dermal epithelium (tegument), 3 layers of smooth muscles (ring, longitudinal and diagonal) are beneath it. **The digestive system:** 2 departments — a front intestine (mouth, pharynx) and a middle intestine locked blindly. Tape worms have no digestive system. The excretory system is of a pronephric type. The nervous system: a paralymploid nervous ring, supra-pharyngeal and sub-pharyngeal ganglia, longitudinal nervous trunks, the lateral ones being most developed. The tactile organs and organs of chemical senses are developed. The majority of species are **hermaphrodites**. Interspaces between organs are filled with the parenchyma. The phylum

includes 3 classes: Cilia worms (*Turbellaria*), Flukers (*Trematoda*) and Tape worms (*Cestoidea*).

2. Progressive organization features of suckers and features of adaptability to a parasitic style of life.

The body of flukers is leaf-like from 2 to 80 mm long. Fixation organs are located on the abdominal side — a mouth and abdominal sucker. The tegument defends the parasite from digestion in the host's organism. The majority of flukers are hermaphrodites. A male sexual system: branching or compact testicles, semen ducts, ejaculating canal, cirrus. A female sexual system: an unpaired ovary, uterus, vitelline gland, ootype, special glands (Mellis' bodies). Flukers have complex development cycles; produce thousands and tens of thousands of eggs daily. An asexual reproduction of larval stages is called polyembryony.

3. Peculiarities of development cycles in trematodas.

Principal hosts: vertebrate animals and humans, **intermediate hosts** — fresh-water mollusks (1st host), fish, cancroids, crabs (2nd host). A sex-mature stage of suckers — *marita* — lays eggs in the organism of the principal host (fig. 32).

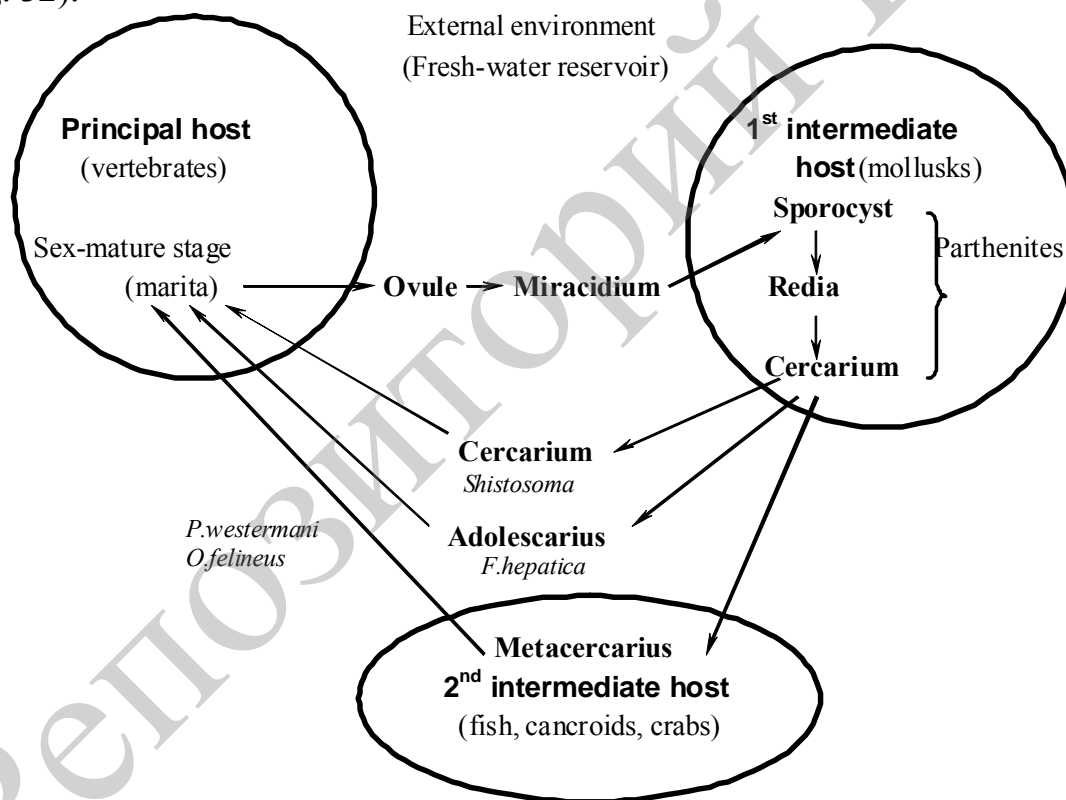

Fig. 32. Diagram of the flukers' life cycle

The egg should get into water for further development. The egg gives a larva — a miracidium. The miracidium swims in water and permeates the intermediate host's body — a mollusk, where it undergoes sporocyst stages during which a redia generation develops; and in redia — a generation of cercaria. They

leave the mollusk's body and freely swim in water. A dormant stage of cercaria on water plants is adoloscercarium. The majority of species of trematodas have the 2nd **supplementary host** (fish, craw-fish and crabs). Cercaria permeate its body by a sharp style and transforms into *metacercaria*. For a principal host (a human) invasive stages can be *metacercaria*, *adoloscercaria* or *cercaria*.

Diseases caused by flukers are called **trematodoses**.

4. Liver fluker.

Fasciola hepatica — a biohelminth, pathogen of fascioliasis. The disease is common everywhere.

Morphological peculiarities: the shape is leaf-like; 3–5 cm in length, 2 suckers — a mouth and abdominal one. Intestinal canals are rather branched. Behind the abdominal sucker is a uterus, and beneath it — a branches ovary, on the body sides — viteline gland, in the middle part — testicles (fig. 33).

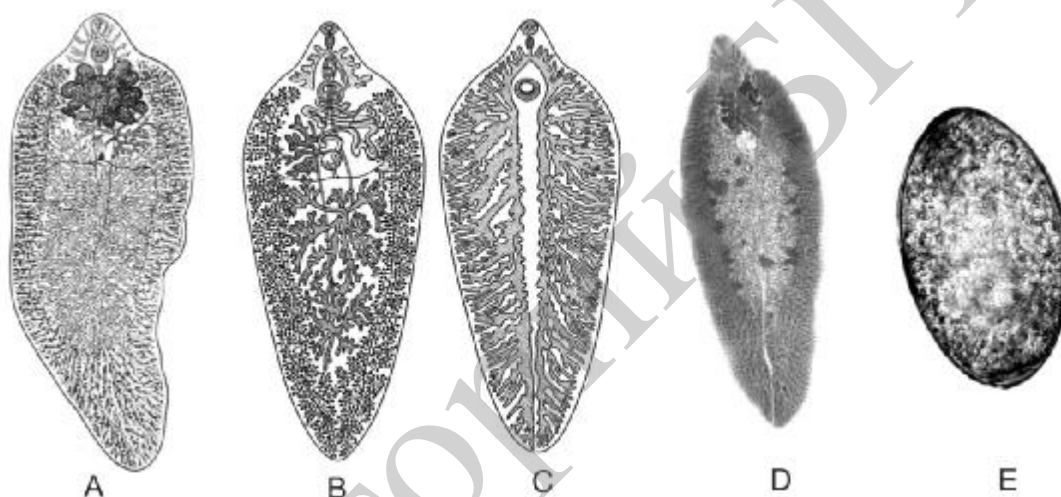

Fig. 33. Morphological peculiarities of *F. hepatica*:

A — a sketch of the parasite's structure; *B* — the genital system structure; *C* — the digestive system structure; *D* — *F. hepatica* (magnifier); *E* — an egg of *F. hepatica* (7×40)

Development cycle: principal hosts — herbivorous animals, sometimes a human. An intermediate host — a mollusk (*Limnea truncatula*). Life cycle stages: marita – egg – miracidium – sporocyst – redium – cercarium – adolesca- rium. The human is infected wile drinking water from stagnant water reservoirs or eating improperly washed vegetables and greenery, which may have adoles- cercaria on them. In the intestines the membrane of adolescertcaria is dissolved, parasites permeate into the liver through the portal vein or through the intestinal wall into the abdomen, and then — into the liver.

Pathogenic action:

1. *Mechanic* (destruction of hepatic cells and obstruction of bile ducts). Liver cirrhosis develops in intensive invasion.
2. *Toxic-allergic* (poisoning by waste products).
3. *Feeding on the host and metabolic impairments* (absorption of nutrients and vitamins).

Characteristic symptoms: pains in the right hypochondrium, nausea, vomiting, jaundice of scleras, indigestion, weakness, headache, skin itching, rash and fever. The liver is enlarged, dense and painful. Complications: inflammation of bile ducts, liver abscess, jaundice.

Laboratory diagnosis: revealing of eggs in feces or duodenal content. Eggs are large ($135 \times 80 \mu\text{m}$), oval and yellowish-brown, there is a lid on one of the poles. Eggs (transit) may be revealed in healthy people after eating liver of animal sick with fascioliasis. Immune examination is effective.

Prophylaxis: not to use water for drinking and watering vegetable gardens from open reservoirs; to wash vegetables thoroughly; to reveal and treat sick persons, sanitary popularization activity, sanitize animals, provide protection of water reservoirs from contamination with feces of sick animals and people.

5. Cat liver fluke.

Opisthorchis felineus — a biohelminth, pathogen of opisthorchiasis. The disease is common in Siberia along the banks of large rivers. Some foci occur in Belarus and other countries.

Morphological peculiarities: the body length is 10 mm. There is a uterus in its middle part, then — a rounded ovary and a bean-like semen-receiver. There are 2 rosette-like testicles in the back part of the body, and between them is an S-shaped canal of the excretory system. The middle intestine canals do not branch; viteline glands are located on both sides of the body (fig. 34).



Fig. 34. Morphological peculiarities of *O. felineus*:

A — a sketch of the marita's structure; B — a marita ($\times 20$); C — a sketch of the egg structure; D — an egg (7×40)

Development cycle: principal hosts — the human, cat, dog and other fish-eating animals. The first intermediate host — fresh water mollusks (*Bithynia leachi*), the 2nd — fresh water fish, of Life cycle stages: marita – egg – miracidium – sporocyst – redium – cercarium – metacercarium. Infecting of the human occurs in eating undercooked fish, containing metacercaria. Maritas are localized in the liver and pancreas of a principal host.

Pathogenic action:

1. *Mechanic* (injury of the walls of bile ducts and their obstruction by suckers, impairment of the liver and pancreas).
2. *Toxic-allergic* (poisoning by waste products).
3. *Feeding at cost of the host and impairment of metabolic processes*.
4. *Mutagenic* (The primary liver cancer is often the case).

Characteristic symptoms: severe pains in the right hypochondrium (in the liver area), worsening of appetite, nausea, vomiting, indigestion, weakness, headache. The liver is enlarged.

Laboratory diagnosis: revealing of eggs in feces or duodenal content. Eggs are $26\text{--}30 \times 10\text{--}15 \mu\text{m}$ in size, of yellowish-brown color, oval, there is a lid on one pole. Immunological methods — revealing anti-bodies in the blood serum.

Prophylaxis: eating properly boiled, fried or salted fish; observing the rules of salting fish, revealing and treating sick persons, protection of water from contamination with feces of animals and people, sanitary-popularization activity.

6. Lung fluke.

Paragoniums westermani — a biohelminth, pathogen of paragonimosis. The disease is common in the South-Eastern Asia and South Asia, Central Africa and South America.

Morphological peculiarities: the body shape is egg-like, a bit flattened in a dorsal-ventral department; the length is 7,5–12 mm (fig. 35). On the sides from an abdominal sucker a lobular ovary is on one side, and the uterus — on the other. Viteline glands are located in lateral parts of the body. Backward from the uterus and ovary are 2-blade testicles.

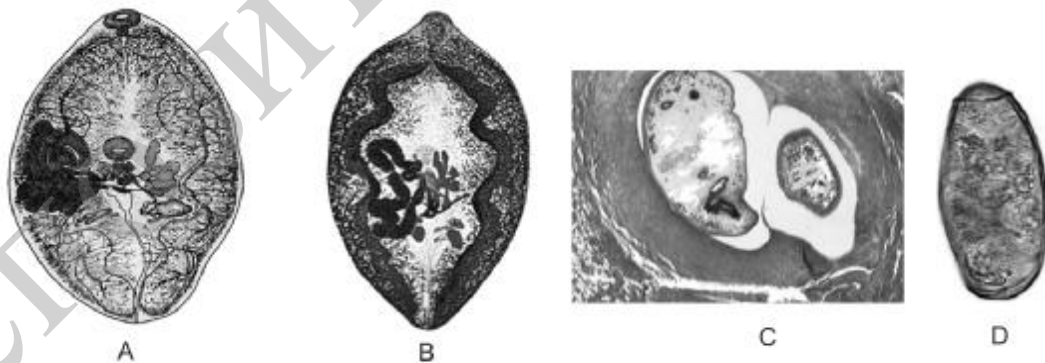

Fig. 35. Peculiarities of *P. westermani* morphology:

A — a marita structure sketch; *B* — a marita ($\times 20$); *C* — parasites in the lung tissue; *D* — an egg (7×40)

Development cycle: principal hosts — a human, dog, cat, pig and other mammals. The 1st intermediate host — fresh water mollusks of g. *Melania*, the 2nd — craw-fish and crabs. *Life cycle stages:* marita – egg – miracidium –

sporocyst – redium – cercarium – metacercarium. Infecting of the human occurs while eating craw-fish and crabs having metacercaria. In the gastro-intestinal tract of the host parasites are released of their membranes, permeate into the abdomen through the intestinal wall, and then through the diaphragm — into the pleura and lungs. Localization of a marita — small bronchi, where cavities are formed around parasites; they are filled with exchange products and tissue decay. Eggs are excreted into the environment with mucous discharge or feces.

Pathogenic action:

1. *Mechanic* (injury of the intestinal wall, diaphragm, pleura and lungs).
2. *Toxic-allergic* (poisoning by waste products).
3. *Feeding on the host's organism and impairment of metabolic processes.*

Characteristic symptoms: chest pains, breathlessness, cough with purulent sputum and sometimes with blood, elevation of temperature, headache. Complications: cardio-pulmonary insufficiency, brain abscesses, meningoencephalitis.

Laboratory diagnosis: revealing eggs in the sputum or feces. Eggs are large (up to 100 μm), oval, of yellowing color, with a lid and a thick membrane.

Prophylaxis: not to eat craw-fish and crabs improperly cooked; sanitary-popularization activity, protection of water reservoirs from contamination by feces of humans and animals, revealing and treating sick persons.

7. Blood flukers.

Schistosomes (blood flukers) inhabit countries with a tropical and sub-tropical climate. In humans one can meet: *Schistosoma haematobium*; *S. japonicum*: *S. Mansoni*. *S. haematobium* — is a pathogen of a urogenital schistosomosis (bilgariasis). *S. Mansoni* — is a pathogen of an enteric schistosomosis. *S. japonica* — is a pathogen of a Japanese schistosomosis (Katayama disease) — a variety of an enteric schistosomosis with severe affections of the intestines, liver, sometimes CNS.

Morphological peculiarities: have separate sexes, a male's body is short and broad (10–15 mm), a female's one up to 20 mm (fig. 36). The female takes place in the gynecofornous canal on the abdominal side of the male. Males have a developed abdominal sucker, which ensures a reliable fixation to the walls of blood vessels.

Development cycle: principal hosts — the human and various mammals, intermediate hosts — fresh-water mollusks. Life cycle stages: marita – egg – miracidium – sporocyst I – sporocyst II – cercarium. Maritas are localized in veins of the abdominal cavity and human urogenital system. Females lay eggs in the vascular lumen of the bladder walls, intestines. Eggs have sharp thorns, which help them get into the organ lumen and then into water, and develop in the mollusk's body. Cercaria leaves mollusks and actively implant into the human skin during bathing, working in water, drinking water from open reservoirs. Clothes do not protect from permeation of cercarias. In the organism cercarias migrate

through lymphatic and blood vessels into the right atrium, right ventricle and then to the lungs, further — into veins of mesentery, intestines, urogenital system.

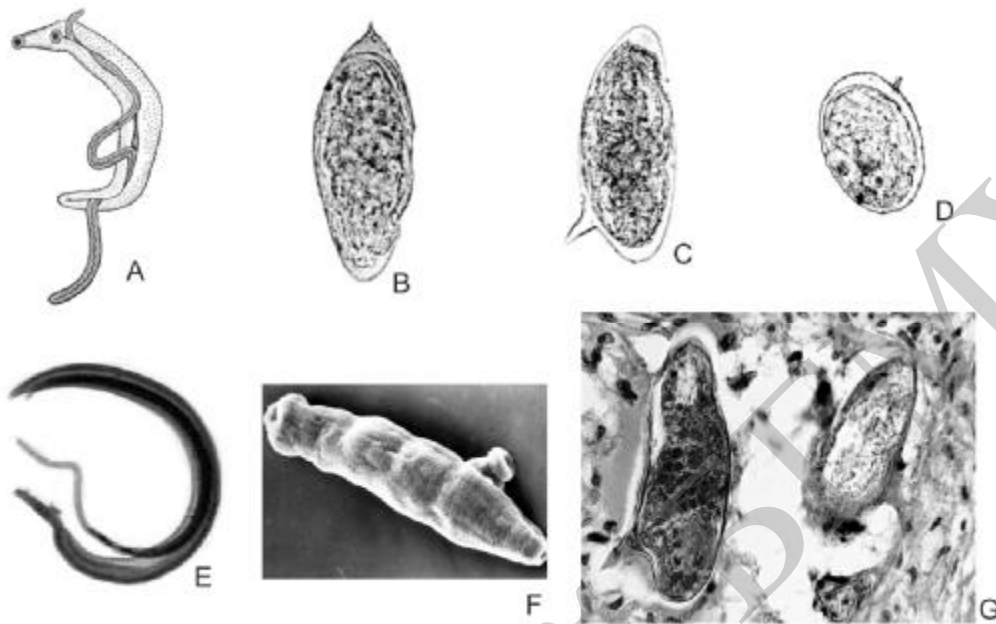

Fig. 36. Morphology peculiarities of schistosomosis pathogens: A — a sketch of the marita structure; B — an egg of *S. haematobium* (7×40); C — an egg of *S. Mansoni* (7×40); D — an egg of *S. japonicum* (7×40); E — maritas (×20); F — a schistosomule (7×40); G — an egg of *S. Mansoni* in the wall of the intestines (7×40)

Pathogenic action:

1. *Mechanic* (walls injury of the urogenital system and intestines by eggs).
2. *Toxic-allergic* (poisoning by waste products).
3. *Feeding on the host's organism and impairment of metabolic processes* (absorption of nutrients, vitamins, corpuscular elements of blood).
4. *Mutagenic* (provoke cancerous diseases of the bladder, urinary ducts and intestines).

Characteristic symptoms: dermatitis, itching at the site of cercaria invasion. In the migration period of young schistosomes there appears cough with mucus and hemoptysis, symptoms of bronchial asthma on the background of general malaise, headache, weakness and lowered appetite.

Characteristic signs of a urogenital schistosomosis are: disuria (impairment of urination) hematuria (excretion of blood at the end of urination), painful urination.

Characteristic signs of an **enteric** schistosomosis are: pains in the abdomen, irregular stool, the presence of blood and mucus in feces, diarrhea, edema of lower extremities and the abdomen.

Laboratory diagnosis: revealing eggs of *S. Mansoni* and *S. japonicum* in feces and biopates of the intestinal mucous membrane; eggs of *S. haematobium*

in urine and bioplates of the bladder mucous membrane. Immunological methods are used.

Prophylaxis: not to bathe, wash, not to drink, not to use water for domestic needs, which contains cercaria; revealing and treating sick persons, protection of water reservoirs from contamination with urine and feces, sanitary-popularization activity.

8. Biological bases of prophylaxis of trematodosis.

It is a complex of measures that are based on studying biology of the pathogen, migration ways, development stages, biology of intermediate hosts that give a possibility to interrupt some link of the parasite development cycle.

Basic terms and concepts:

- 1. Adolescarium** — a dormant larval stage of the liver sucker.
- 2. Dermo-muscular sac** — a body wall of flat worms that is formed by tegument and 3 layers of smooth muscles.
- 3. Marita** — a sexually mature stage of flukers.
- 4. Metacercarium** — an invasive stage for a final host in the development cycle of flukers.
- 5. Miracidium** — the 1st larval stage in the flukers development cycle.
- 6. Redium** — a larval stage of flukers in the organism of the 1st intermediate host.
- 7. Sporocyst** — a larval stage of flukers. That develops in the organism of the 1st intermediate host from a miracidium.
- 8. Tegument** — an external layer of a dermato-muscular sac of flukers.
- 9. Cercaria** — a mobile larva of the fluker that is excreted from the mollusk's organism into water.

PHYLUM PLATHELMINTHES, CLASS CESTOIDEA

1. Characteristic of the class of tape worms, adaptability features to parasitism.

There are 1800 species of endoparasites, their body is flattened in a dorsal-ventral direction, looks like a tape. Sizes from 1 mm to 10–18 m in length. At the front end is a head (*scolex*) with fixation organs: *suckers*, *a proboscis with hooks*, *bothria*; then goes a neck, then a body (*strobila*) consisting of segments (*proglottid*). New proglottids detach themselves and come outside. An external layer of the dermato-muscular sack, *tegument*, has hair-like growths (*microtrichia*) that absorb nutrients from the host's intestines. The digestive, circulation and respiratory systems are absent. The excretory system is presented by protonephridia. The nervous system and sense organs are poorly developed. Cestodes are hermaphrodites. In proglottids, beginning with the neck, there develops a

male sex system at first, then a female one (hermaphroditic segments in the middle of the strobila); in mature segments (at the end of the body) there stays a uterus filled with eggs. In tenia the uterus is closed, in Diphyllbothria — open.

2. Peculiarities of development cycles in tenia and Diphyllbothria.

Types of finnas. The larva of an oncosphere (a 6-hooked round-shaped germ) develops in the egg. In the intestines of an intermediate host the oncosphere comes out of membranes, permeates into blood vessels using hooks, is carried to tissues and organs and transformed into a *finna* (fig. 37).

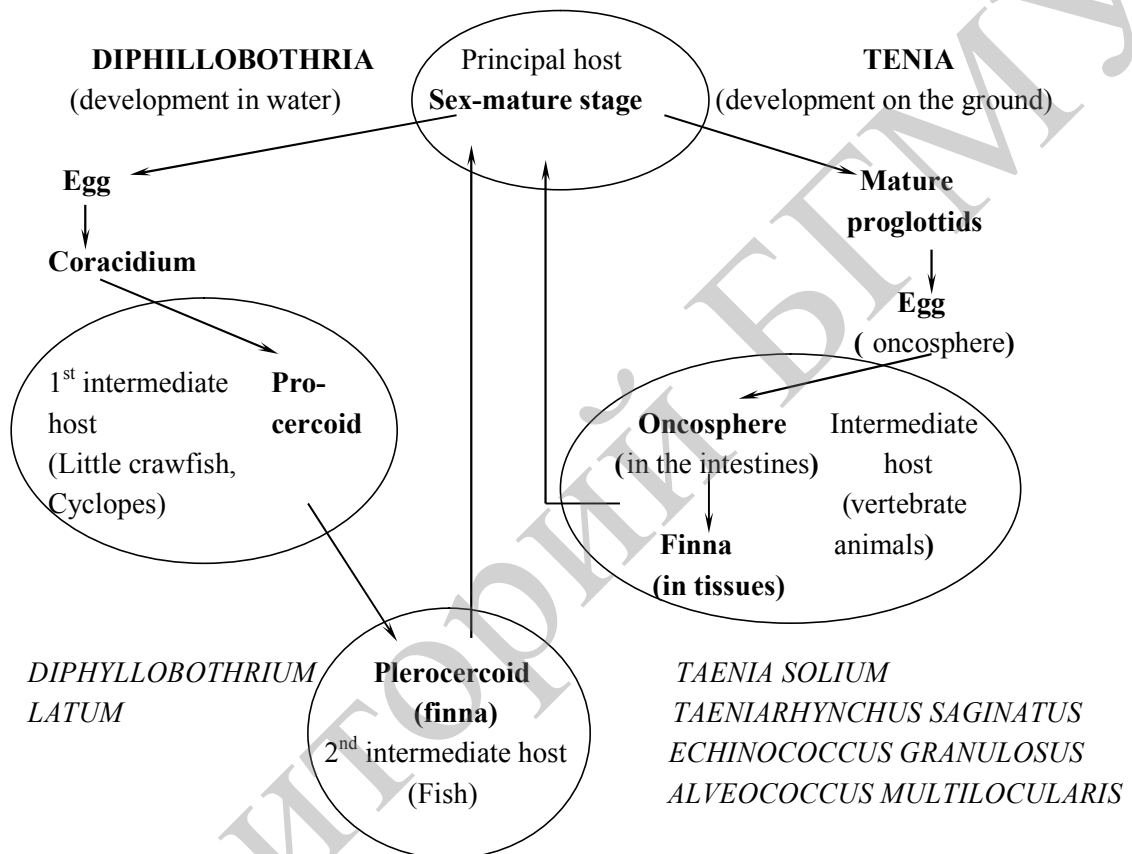

Fig. 37. Diagram of development cycles of cestodes

A cysticerc is a bladder-like finna filled with fluid, inside of which one scolex is screwed. The *coenurus* is a bladder with several screwed heads. *A cysticercoid* has a widened part with a screwed scolex, and behind — a caudal appendix. An *echinococcus* — is a finna as a large mother bladder with daughter and granddaughter bladders, inside of which are scolexes. A *plerocercoid* is a worm-like larva with two bothria. Finnas develop into an adult individual in the intestines of final hosts. Under the action of digestive juices the scolex screws outside, attaches to the intestinal wall, and proglottids start detaching themselves from the neck.

Diseases caused by cestodes are *cestodoses*.

3. Taenia solium and Taeniarhynchus saginatus.

Taeniarhynchus saginatus — is a biohelminth, a pathogen of teniarhynchosis. The disease is common everywhere.

Morphological peculiarities: the length of a sexually mature parasite is 4–10 m. There are 4 suckers on the skolex. Hermaphrodite proglottids have a double-lobular ovary, viteline glands are located under it; vesicle-like testicles — in lateral parts of a proglottid. The uterus in sexually mature segments contains 17–35 side branches and contains up to 175 000 eggs (fig. 38). Mature segments may crawl out of an anal opening and move along the human body and linen.

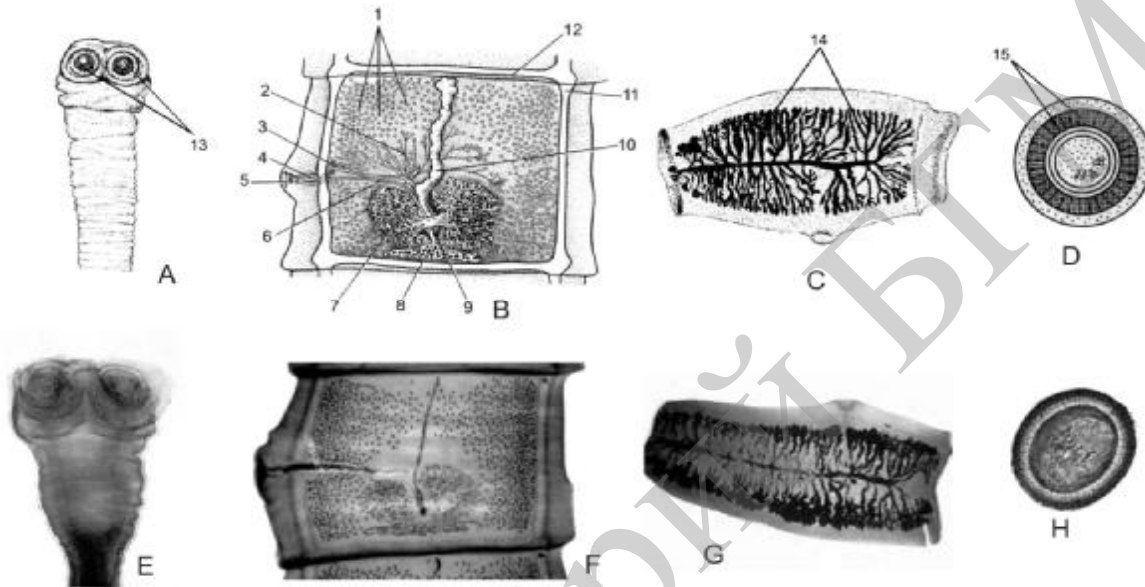

Fig. 38. Morphology of *Taeniarhynchus saginatus*:

A–D — sketches, *E–H* — microphotographs: *A, E* — skolexes, *B, F* — hermaphrodite proglottids, *C, G* — mature proglottids, *D, H* — eggs: 1 — testicles; 2, 3 — semen ducts; 4 — cirrus; 5 — sexual cloaca; 6 — vagina; 7 — ovary; 8 — viteline gland; 9 — ootype; 10, 14 — uterus; 11, 12 — excretory canals; 13 — suckers; 15 — radial banding

Development cycle: a principle host is a human, an intermediate one — cattle that get infected while swallowing eggs of tenia with grass. The human gets infected while eating undercooked beef with finnas (cysticercs). The life span of tenia in the human organism is up to 25 years.

Pathogenic action:

1. *Mechanic* (by irritation of the intestinal mucous membrane by suckers).
2. *Toxic-allergic* (poisoning by waste products).
3. *Feeding on the host's organism and impairment of metabolic processes.*

Characteristic symptoms: itching around the anus, pains in the abdomen, unstable stool, weakness, impairment of appetite, loss of weight.

Laboratory diagnosis: revealing segments or eggs in feces. Eggs are rounded, have a double-contour lined thick membrane, inside they contain a 6-hooked oncosphere.

Prophylaxis: personal — not to eat untested beef. **Social** — making a veterinary expertise of cattle carcasses, revealing and treating sick persons, protecting pastures from contamination with human feces, building sanitary facilities in settlements (closed toilets in rural areas), sanitary-popularization activity.

Taenia solium — a biohelminth, causes teniasis in the human (a sexually mature form) and cysticercosis (a larval form).

Morphological peculiarities: the length of a sexually mature form is 2–3 m, there are 4 suckers and a proboscis with 2 rows of hooks on the skolex (fig. 39).

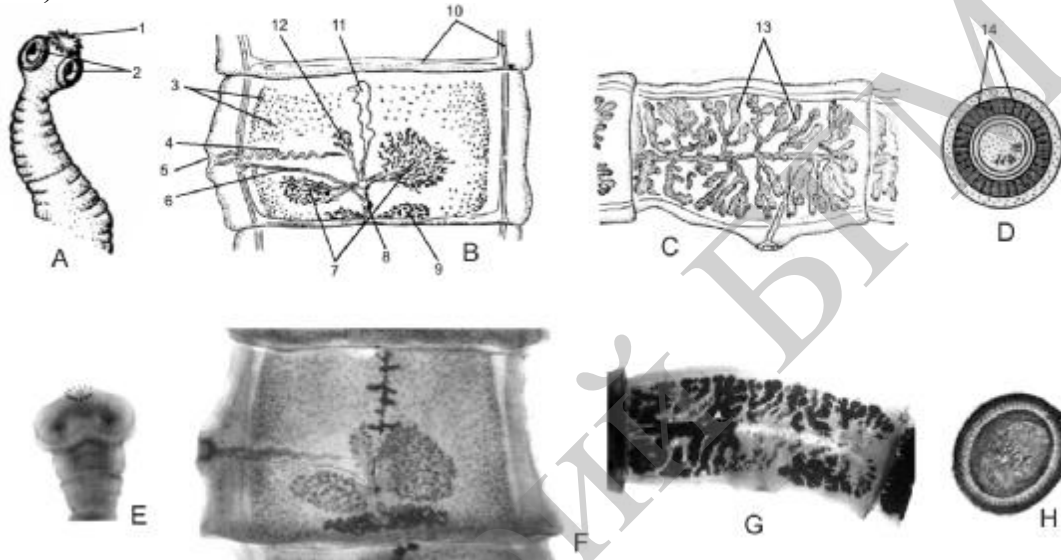

Fig. 39. Morphology peculiarities of *Taenia solium*:

A–D — sketches, *E–H* — microphotographs: *A, E* — skolexes, *B, F* — hermaphrodite proglottids, *C, G* — mature proglottids, *D, H* — eggs: 1 — hooks; 2 — suckers; 3 — testicles; 4 — a semen duct; 5 — a sexual cloaca; 6 — a vagina; 7 — an ovary; 8 — an ootype; 9 — vitelline gland; 10 — excretory canals; 11, 13 — uterus; 12 — additional lobe of the ovary; 14 — radial lining

A hermaphrodite proglottid contains a 3-lobed ovary. A mature proglottid contains a uterus with 7–12 lateral branches. Mature segments are immobile.

Development cycle: a principal host is a human, an intermediate — domestic or wild pigs, sometimes a human. Getting infected by teniasis occurs while eating undercooked pork with cysticercs. In the intestines under the action of digestive juices a scolex cysterca screws out, fixes itself to the intestinal wall, and proglottids begin detach themselves. In 2–3 months a helminth reaches its sexual maturity. The life span of a tenia is several years.

Pathogenic action is similar to that of *Taenia solium*.

Characteristic symptoms: pains in the abdomen, nausea, vomiting, indigestion, headache, dizziness.

Laboratory diagnosis: revealing segments or eggs in feces. Eggs of *Taeniarhynchus saginatus* and *Taenia lolium* are similar.

Prophylaxis: personal — not to eat untested pork. **Social** — veterinary expertise of carcasses of pigs and wild pigs, revealing and treating sick persons, protection of the environment from contamination with human feces, building sanitary facilities in settlements (closed toilets), sanitary-popularization activity.

Cystercosis. The pathogen of cystercosis is a larval stage of an armed цепеня — cysticerc. **The human gets infected with cystercosis:**

1) when neglecting rules of personal hygiene and swallowing eggs which can be on hands and food;

2) in autoinvasion: if a person is ill with teniasis, proglottids may get into the stomach during vomiting, under the action of digestive juice oncospheres are released and in various organs (subcutaneous cellular tissue, muscles, eyes, brain) finnas develop;

3) in treating teniasis with preparations that dissolve proglottids.

Pathogenic action:

1. *Mechanic* (pressure on tissues).

2. *Toxic-allergic* (poisoning by waste products).

Symptoms depend on intensity of infection and localization of cysticercs. Their presence in CNS is accompanied by headaches, convulsion attacks, paralysis of extremities and may even end with a fatal outcome. Intra-ocular cystercosis may cause a complete loss of vision.

Laboratory diagnosis: immunological methods.

Prophylaxis: personal — observing rules of hygiene, **social** — sanitary-popularization activity, revealing and treating sick persons.

4. Dwarf tenia.

Hymenolepis nana — is a contact helminth, a pathogen of hymenolepidosis. Pre-school children fall ill more often.

Morphological peculiarities: the length of a tenia is 1–5 cm, contains about 200 proglottids, there are 4 suckers and a proboscis with a double corolla of hooks on a scolex. The uterus is closed, but a thin wall of proglottids is easily destroyed and eggs come outside into the intestinal lumen (fig. 40).

Development cycle: the human and a principal and intermediate host. Infection occurs in neglecting rules of personal hygiene and swallowing eggs of tenia, from which oncospheres come out in the small intestine. They implant into cilia of the intestinal mucous membrane and transform into cysticercoids. Finnas destroy a cilia, fall into the intestinal lumen, attach to the mucous membrane and in 2 weeks form sexually mature forms. The parasite's life span is 1–2 months. The development of oncospheres is possible without passing into the environment and it leads to autoreinvasion.

Pathogenic action:

1. *Mechanic* (destruction of cilia of a thin intestine, irritation of the mucous membrane by fixation organs of the parasite).

2. *Toxic-allergic* (poisoning by waste products).

3. Feeding on the host's organism and impairment of metabolic processes.

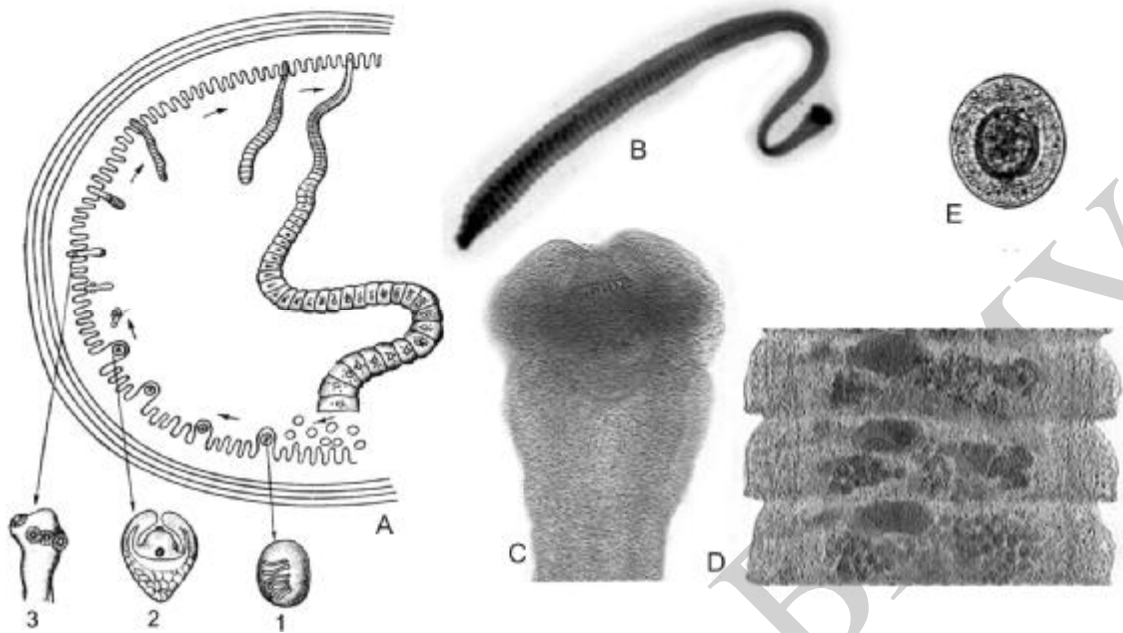

Fig. 40. Morphology of *Hymenolepis nana*:

A — a development sketch in a small intestine: 1 — an oncosphere; 2 — a cysticercoid; 3 — a skolex; B — a tape form ($\times 20$); C — a skolex (7×8); D — mature proglottids (7×8); E — an egg (7×40)

Characteristic symptoms: pain in the abdomen, worsening of appetite, nausea, indigestion, general weakness, irritability; in intensive invasions — vomiting, dizziness, seizures, fainting. Children retard in mental and physical development.

Laboratory diagnosis: revealing eggs in feces. Eggs are rounded with 2 translucent membranes, between which pass twisting filaments.

Prophylaxis: personal — observing rules of hygiene. **Social:** 1) cultivating hygienic skills in children; 2) revealing, isolating and treating sick persons; 3) thorough wet cleaning of children's rooms and sanitary treatment of toys; 4) sanitary-popularization activity.

5. *Tenia echinococcus* and *alveococcus*.

Echinococcus granulosus — is a biohelminth, a pathogen of echinococcosis.

Morphological peculiarities: the length is 3–5 mm. The scolex has suckers and a proboscis with 2 rows of hooks. The strobila consists of 3–4 proglottids. The last but one proglottid is hermaphrodite, the last one — mature. The uterus is branched, closed (fig. 41).

Development cycle: principal hosts — carnivorous animals (dogs, wolves, coyotes), intermediate ones — the human, herbivorous and omnivorous animals (large and small cattle, pigs, camels, deer, etc.).

Infection of final hosts occurs in eating organs of affected animals. Finns in the intestines give a great number of sexually mature forms. Mature proglot-

tids of tenia are capable of crawling from the anus and moving on the animal hair scattering eggs. Eggs and proglottids, having got on the grass, are swallowed by intermediate hosts. In the intestines, oncospheres come out of eggs, get into the blood stream and are carried to various organs (liver, lungs), where a finna develops. The human gets infected from sick dogs while neglecting rules of personal hygiene. There is a possibility to get infected from sheep and other animals, the hair of which contains eggs that have got there from grass or soil. In the human echinococcus affects the liver, lungs, brain, muscles and bones.

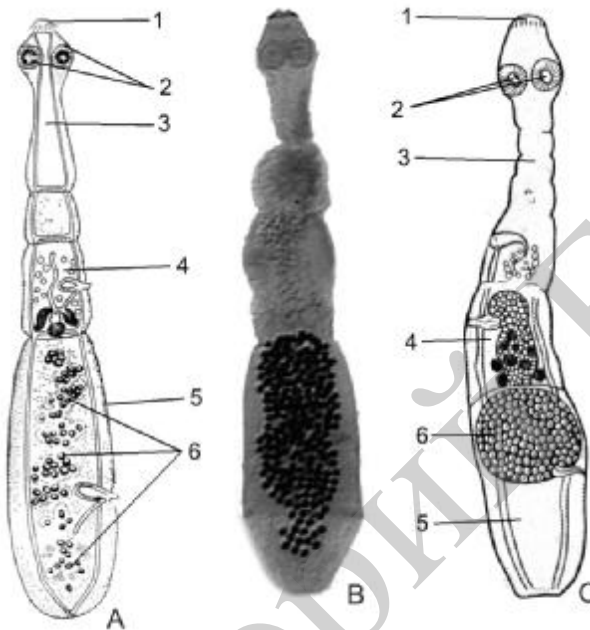

Fig. 41. Morphology of *Echinococcus granulosus* and *Alveococcus multilocularis*: A, B — *Echinococcus granulosus*; C — *Alveococcus multilocularis*: 1 — a proboscis with 2 corollas of hooks; 2 — a sucker; 3 — a neck; 4 — a hermaphrodite proglottid; 5 — a mature proglottid; 6 — a uterus; A, C — sketches; B — a microphotograph (7×8)

Pathogenic action:

1. *Mechanic* (pressure on tissues and destruction of affected organs).
2. *Toxic-allergic* (poisoning by waste products).

Characteristic symptoms: skin itching and rash, pain and pressure in the right hypochondrium. If a left lung is affected, the patient suffers from pains in the chest, cough, breathlessness, sometimes hemoptysis. The echinococcus bladder may burst into a bronchus, abdominal and thoracic cavity or become purulent. These complications may result in a fatal outcome.

Laboratory diagnosis: is based on an X-ray and immune examination (revealing anti-bodies in the blood serum).

Prophylaxis: personal — observing rules of hygiene, washing hands after dealing with dogs, sheep, the hair of which can contain eggs of echinococcus. **Social** — dehelminthization of service dogs, never feed them with animals organs affected by echinococcus, killing stray dogs, sanitary-popularization activity.

Alveococcus, *Alveococcus multilocularis* — a biohelminth, pathogen of alveococcosis.

Morphological peculiarities: sexually mature forms of echinococcus and alveococcus are similar, but an alveococcus has a ball-like uterus; a finna of alveococcus is filled with a jelly-like mass; daughter bladders detach themselves only outside (fig. 41). Alveococcus is called a multichamber echinococcus.

Development cycle: final hosts are carnivorous animals (foxes, dogs, cats, polar foxes). Intermediate hosts — are mice-like rodents, sometimes — the human. The human may get infected through dirty hands after contact with skins of foxes and wolfs, from dogs, while eating contaminated vegetables, forest berries and water.

Pathogenic action is similar to the action of echinococcus. Alveococcosis has a malignant course: daughter bladders detach themselves outside, proliferate into adjacent tissues (growth as in malignant tumors).

Characteristic symptoms: are similar to those of echinococcus and depend on localization of the parasite.

Laboratory diagnosis: an immunological and X-ray methods.

Prophylaxis is the same as in echinococcosis.

6. *Diphyllobothrium latum* — a biohelminth, pathogen of diphyllobothriosis.

Morphological peculiarities: the body length is 10–18 m. There are 2 sucking slots on the skolex — bothria. The size of proglottids in width is larger than in length (fig. 42). Mature proglottids contain an open rosette-like uterus.

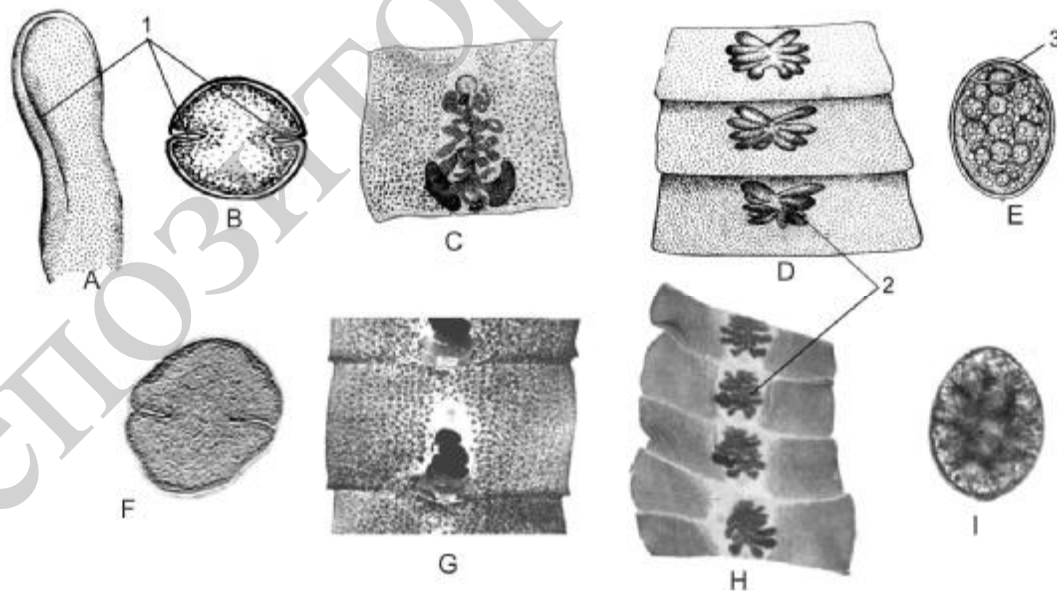

Fig. 42. Morphology of *Diphyllobothrium latum*:

A–E — sketches; *F–I* — microphotographs; *A* — a skolex, *B*, *F* — a transverse section of the skolex, *C*, *G* — a hermaphrodite proglottid, *D*, *H* — a mature proglottid, *E*, *I* — an egg; *I* — bothria; 2 — a uterus; 3 — an egg

Development cycle: principal hosts — the human and fish-eating mammals (cats, dogs, polar foxes, bears), the 1st intermediate host — small craw-fish (Cyclops, daphnia), the 2nd — fish, a reservoir host — predator fish. Eggs are excreted with feces out of the organism of a final host. They get into water, where in 3–5 weeks they excrete a larva, *coracidium*. The coracidium is swallowed by the 1st intermediate host. The coracidium transforms into a larva in its intestines, a *proceroid*. When a fish swallows a small craw-fish, the proceroid transforms in its muscles and sexual organs into a *plerocercoid*. Principal hosts get infected while eating fish or caviar containing plerocercoids. The life span of *Diphyllobothrium* in the human organism is up to 25 years. The localization of the parasite is a small intestine.

Pathogenic action:

1. *Mechanic* (injures a mucous membrane of the intestines by bothria).
2. *Toxic-allergic* (poisoning by waste products).
3. *Feeding on the host's organism and impairment of metabolic processes* (selectively absorbs vitamin B₁₂, which results in the development of malignant anemia)

Characteristic symptoms: weakness, nausea, pain in the abdomen, meteorism, subfebrile temperature. Signs of anemia appear: sharp general weakness, sleepiness, dizziness, dyspeptic events. Bright-red spots and fissures appear on the tongue, atrophy of nipples occurs. The skin is pale with a yellowish shade; the liver and spleen are enlarged.

Laboratory diagnosis: revealing eggs and proglottids in feces. Eggs are oval, there is a lid on one pole, on the other — a protuberance.

Prophylaxis: personal — exclusion of raw, half-raw, improperly cooked fish and caviar. **Social** — protection of water reservoirs from contamination with human feces, revealing and treating sick persons, sanitary-popularization activity.

7. Biological bases of cestodoses prophylaxis.

It is a complex of preventive measures that are based on studying the pathogens biology, ways of migration, development stages, biology of intermediate hosts, which gives a possibility to interrupt some link of the parasite development and prevent its further development.

Basic terms and concepts:

1. **Biohelminths** — worms, the development cycle of which occurs while changing hosts.
2. **Bothria** — fixation organs of *Diphyllobothria*.
3. **Contact helminthes** — worms, whose eggs are transmitted in contact of a healthy person with a sick one or through domestic objects.
4. **Plerocercoid** — a finna of a *Diphyllobothria latum*.
5. **A prglottid** — a segment of tape worms.

6. **Scolex** — a head of tape worms.
7. **Strobila** — a body of tape worms consisting of segments.
8. **Cisticerc** — a finna of *Taeniarhynchus saginatus* and *Taenia solium*.
9. **Cysticercoid** — a finna of a dwarf tenia.
10. **Echinococcus** — a tape worm, pathogen of echinococcosis.

PHYLUM NEMATHELMINTHES, CLASS NEMATODA

CLASSES I

1. General characteristic of the phylum of ring worms and the class of ring worms proper.

Over 15 000 species inhabit water, soil, decaying organic substances; many of them have adapted to a parasitic style of life.

Characteristic features of the phylum: 1) they have three layers; 2) a bilateral symmetry of the body; 3) a cylindrical or spindle-like shape of the body; 4) the presence of a dermato-muscular sac and the body primary cavity; 5) the presence of organ systems — nervous, digestive, excretory and genital; 6) they have separate sexes; 7) a posterior intestine and the anus have appeared. The type includes 5 classes. The class of ring worms proper has a medical significance.

Class of ring worms proper (Nematoda). The body is spindle-like, its length is from a mm to 1,5 m, a transverse section presents a circle. The body wall is a *dermato-muscular sac*, consisting of a cuticle, hypoderm and the 1st layer of smooth muscles. The body cavity is primary (*pseudocoel*). It contains internal organs. *The digestive system* is divided into 3 departments: anterior, middle and posterior. *The excretory system* is presented by 1–2 cutaneous glands. The function of excretion is also performed by phagocytes. The nervous system consists of a supra-pharyngeal and sub-pharyngeal ganglia, a para-pharyngeal ring and longitudinal trunks. *Sense organs*: tactile and chemical senses.

Nematodas have separate sexes, a sexual dimorphism is marked: males are smaller than females and their back end of the body is spirally screwed on the abdominal side. *The genital system* is tubular. In females it starts with paired ovaries that pass into egg-ducts, then into the uterus and vagina. The sexual system of males consists of an unpaired testicle, semen duct, ejaculation canal that opens into the posterior intestine. Some species are viviparous. The majority of nematodas are geohelminthes.

Diseases caused by ring worms are called *nematodoses*.

2. Human ascarides.

Ascaris lumbricoides — is a geohelminth, pathogen of ascariasis. The disease is spread everywhere, excluding arctic areas, deserts and semi-deserts.

Morphological peculiarities: the length of a female is 40 cm, of a male — 25 cm. The body is cylindrical, sharpened at the ends; on the anterior end of the body are cuticular lips (fig. 43).

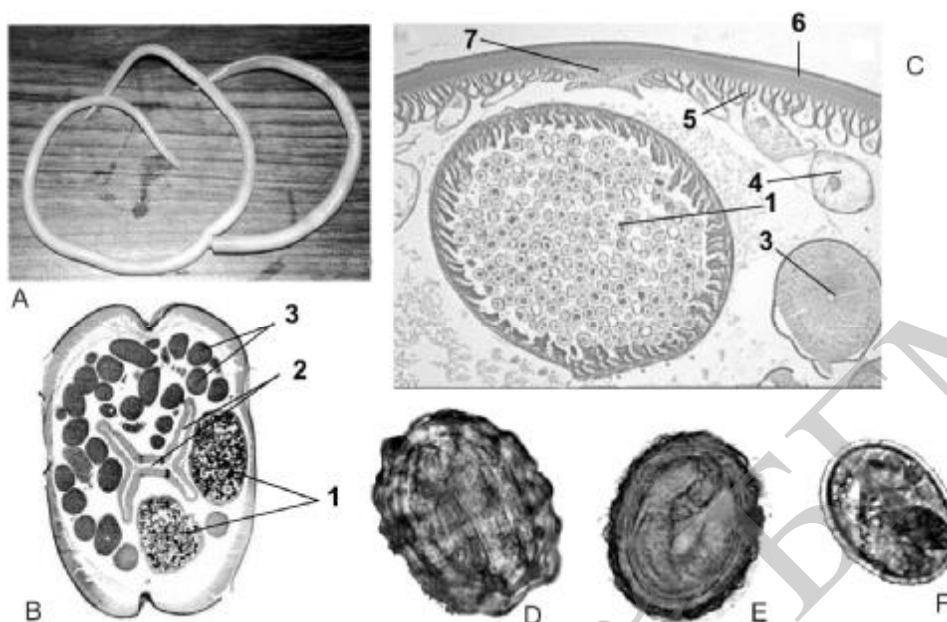

Fig. 43. Morphology of *Ascaris lumbricoides*:

A — sexually mature helminthes (photograph), *B* — a transverse section (7×8), *C* — a fragment of the transverse section in the uterus area (7×40): 1 — the uterus filled with eggs; 2 — a middle intestine; 3, 4 — an ovary; 5 — muscular fibers; 6 — a cuticle; 7 — a hypodermic cylinder; *D*, *E* — fertilized eggs with a larva (7×40); *F* — an unfertilized egg (7×40)

Development cycle: a sexually mature form is localized in a thin intestine. A fertilized female lays up to 240 000 eggs a day, they are excreted into the environment with feces. In soil, when an optimal temperature is 20–25 °C, humidity is sufficient and oxygen is available, infection larvae develop in eggs in 21–24 days. Such eggs get into the human organism with unwashed vegetables, fruit and water. In a thin intestine larvae come out of eggs, perforate its wall, get into blood vessels and accomplish a *migration*: They pass through the liver, right atrium, right ventricle with a flow of blood; then they are carried into the pulmonary trunk and alveolar capillaries. Through the capillary walls larvae get into alveoli, ascend into bronchioles, bronchi, trachea and get into the pharynx, are swallowed. In 2,5–3 months they transform into sexually mature forms in a thin intestine. Larval migration lasts about 2 weeks. The life span of mature ascarides is 1 year.

In the human organism larvae of other ascarid species may also migrate (those of the pig, dog, etc.), they cause a syndrome of Larva migrans.

Pathogenic action of ascarid larvae:

1. *Toxic-allergic* (poisoning by waste products).
2. *Mechanic* (injury of the liver, rupture of capillaries, injury of alveoli, eosinophilic infiltrates in the lungs).

3. *Feeding on the host's organism and impairment of metabolic processes* (absorption of nutrients and vitamins).

4. *Mutagenic*.

Characteristic symptoms of migrational ascariasis: general weakness, fever, headaches, perspiration, a persistent spastic cough especially at night, itching, skin rash, edema of lids and face.

Characteristic symptoms of enteric ascariasis: pains in the abdomen, nausea, vomiting, diarrhea, worsening of appetite, weakness, irritability, worsening of memory, loss of weight.

Complications of enteric ascariasis: mechanic jaundice, purulent pancreatitis, purulent cholangitis, appendicitis, peritonitis, spastic and mechanic intestinal obstruction. Sometimes ascarides are found in frontal sinuses, cranial cavity, middle ear and ovaries.

Prophylaxis: personal — observing rules of hygiene, thorough washing of vegetables, fruit and berries with hot water. It is necessary to protect food from flies and cockroaches — mechanic transmitters of ascarid eggs. **Social** — revealing and treating sick persons, protection of the environment from contamination with ascarid eggs, sanitary-popularization activity.

3. Human vlasoglav (whipworm).

Trichocephalus trichiurus — a geohelminth, pathogen of trichocephaliasis. The disease is common everywhere.

Morphological peculiarities: the length of a female is up to 5 sm, males are a bit shorter. The anterior end of the body is filament-like, the posterior — is thickened. The esophagus is in the anterior department is, in the posterior one — all other organs (fig. 44).

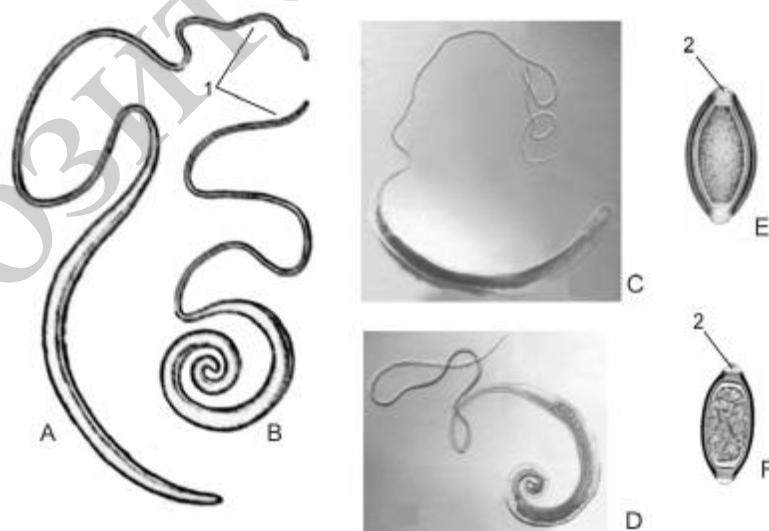

Fig. 44. Morphology of *Trichocephalus trichiurus*:

A, B, E — sketches; C, D, F — microphotographs; A, C — sexually mature females, B, D — males, E, F — eggs: 1 — an anterior end of the body; 2 — a plug on the pole

Development cycle. A fertilized female lays up to 60 000 eggs a day; they are excreted to the environment with feces. The development of eggs occurs in soil. In optimal conditions, when the temperature is 25–30 °C, the humidity is high and oxygen is available, an invasion larva develops in 25–30 days. The human gets infected eating vegetables, fruit and water contaminated with parasite's eggs. In the intestine larvae come out of eggs that in 1–1,5 months transform into sexually mature forms without migration. The vlasoglavs' life span in the human is about 5 years. Parasites are localized in the upper department of a large intestine (mainly in the caecum).

Pathogenic action:

1. *Mechanic* (injury of the mucous membrane of the intestine).
2. *Toxic-allergic* (poisoning by waste products).
3. *Feeding on the host's organism and impairment of metabolic processes* (they «sew» the intestinal mucous membrane by an anterior end and feed on blood).
4. *Mutagenic*.

Characteristic symptoms: pains along a large intestine, irregular stool, meteorism, poor appetite, nausea, vomiting, weakness, headache. *Complications:* anemia, appendicitis and convulsive attacks.

Laboratory diagnosis: revealing vlasoglav's eggs in feces. Eggs have a lemon shape with plugs on the poles.

Prophylaxis: the same as in ascariasis.

4. Seat worms.

Seat worm, *Enterobius vermicularis* — a contact helminth, a pathogen of enterobiosis. The disease is common everywhere.

Morphological peculiarities: the length of a female is about 10 mm, that of a male — 2–5 mm (fig. 45). There are cuticular swellings — vesicles, and on the posterior part of the esophagus — a ball-like dilation — a bulbus, that take part in fixation of the parasite to intestinal walls.

Development cycle: they are localized in the lower department of a small and in the initial department of a large intestine. After fertilization females crawl out of the anus, excrete an irritating fluid and lay eggs on the skin of the perineum. If the temperature is 34–36 °C and humidity is high (70–90 %), the eggs become infectious in 4–6 hours. The patients scratch itching sites and eggs get under nails, which in the morning are brought into the mouth and scattered on surrounding objects. In the intestines larvae come out of eggs and in 2 weeks reach their sexual maturity. The life span of a seat worm is about a month. Pre-school and junior school children fall ill more often.

Pathogenic action:

1. *Mechanic* (injury of the intestinal mucous membrane).
2. *Toxic-allergic* (poisoning by waste products).
3. *Feeding on the host's organism and impairment of metabolic processes*.

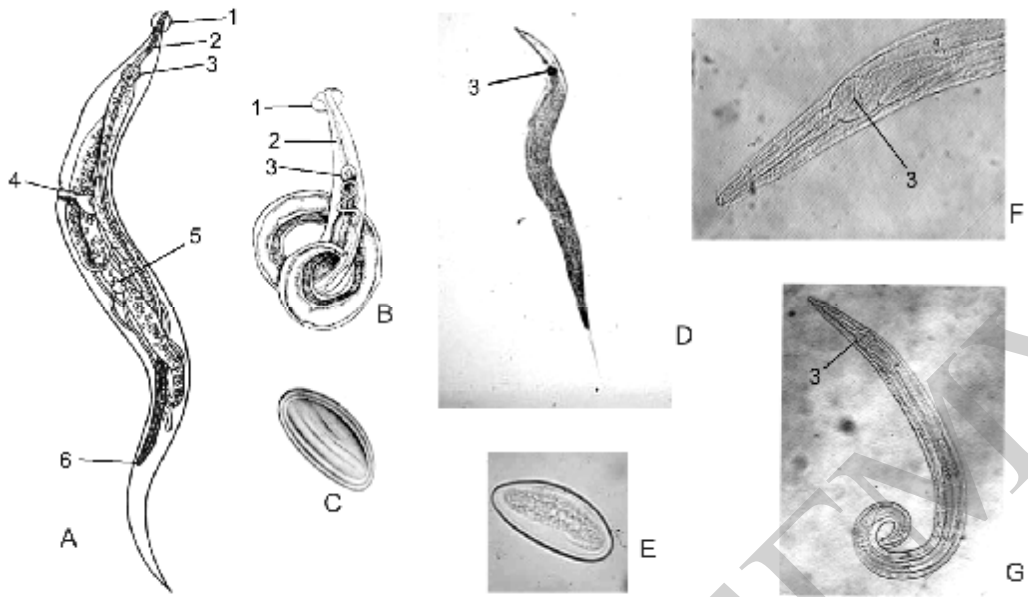

Fig. 45. Morphology of *Enterobius vermicularis*:

A–C — sketches; D–G — microphotographs; A, D, F — a female, B, G — a male: 1 — a vesicle; 2 — the esophagus; 3 — a bulbous; 4 — a genital opening; 5 — the uterus; 6 — the anus; C, E — an egg

Characteristic symptoms: itching and a burning sensation around the anus. Itching troubles day and night, becomes unbearable, spreads to the perineum, sexual organs and abdomen. The well-being and sleep of patients becomes worse, there appears irritability, nervous break-downs, diarrhea with mucus, nausea, vomiting, grumbling and flatulence, the progress in studies becomes worse.

Laboratory diagnosis: revealing eggs by a sticky tape. Eggs are colorless, asymmetric, flattened from one side.

Prophylaxis: observing personal hygiene, clean hands and linen. **Social** — cultivating hygienic skills in children, examination of the personnel of pediatric establishments, isolation and treatment of sick persons, systemic wet cleaning of rooms, sanitary treatment of toys, sanitary-popularization work with parents and educators of pre-school establishments.

5. *Trichinella*.

Trichinella spiralis — a biohelminth, a pathogen of trichinellosis.

Morphological peculiarities: females have sizes of 3–4 mm, males — 1,5–2,0 mm. There is an unpaired sexual tube in females. Larvae are screwed like a spiral and encapsulated with a connective tissue (fig. 46).

Development cycle: they parasitize carnivorous and omnivorous animals (pigs, wild boars, cats, dogs, mice, rats, bears, etc.). One and the same organism is at first a principal (sexually mature forms in the intestines) and then an intermediate host (larvae in muscles). Getting infected occurs while eating meat contaminated with larvae (of pork, meat of wild boars, bears, etc.). In a small intes-

tine capsules of larvae are digested, larvae transform in sexually mature forms. After fertilization females implant into the mucous membrane of a small intestine and produce living larvae. The larvae are carried over the organism by a flow of blood and lymph, stop in the skeletal musculature. The diaphragm, intercostal and masticatory muscles are affected most severely. Larvae get into a muscular fiber and become spiralized. A capsule is formed round larvae, which is calcified in a year. Larvae preserve their vitality in the capsule up to 20–25 years. To transform larvae into sexually mature forms they must get into the intestines of another host. The human is a biological dead end for them.

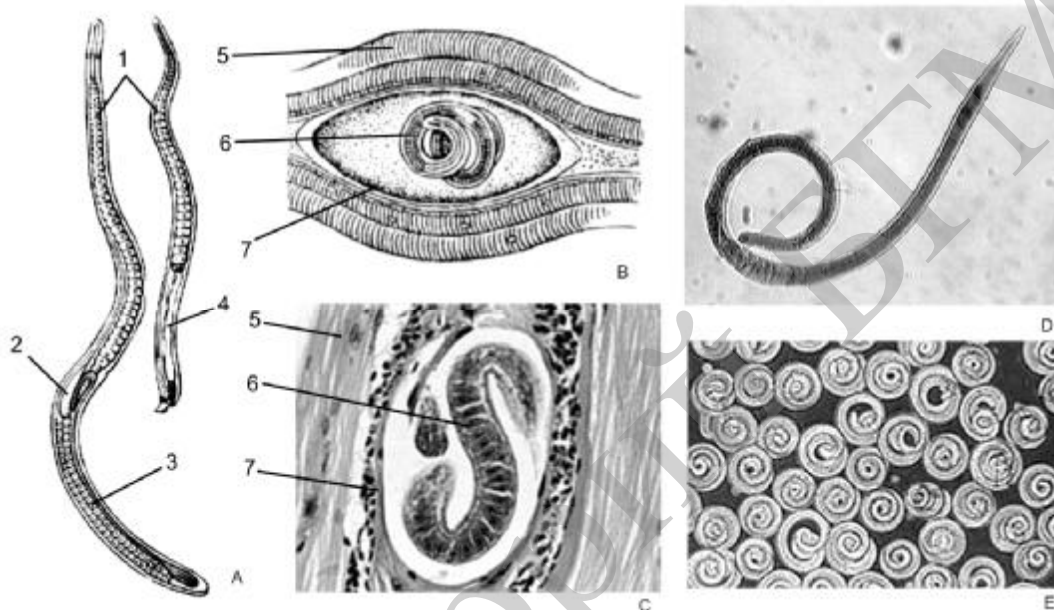

Fig. 46. Morphology of *Trichinella spiralis*:

A — sexually mature forms (a sketch), *B* — an encapsulated larva (a sketch), *C* — an encapsulated larva (7×8): 1 — the esophagus; 2 — the uterus; 3 — an ovary; 4 — a testicle; 5 — a muscular fiber; 6 — a larva; 7 — a capsule; *D* — a male (7×40); *E* — decapsulated larvae (7×8)

Pathogenic action:

1. *Toxic-allergic* (poisoning of the organism by waste products and dead bodies decay).
2. *Mechanic* (injury of intestinal walls and muscular fibers).
3. *Feeding on the host's organism and impairment of metabolic processes.*
4. *Mutagenic.*

Characteristic symptoms: pains in the abdomen, nausea, vomiting, diarrhea. Then allergic rash appears and pain in muscles (ocular, masticatory muscles and muscles of calves, waist and shoulder girdle), the temperature elevates to 40–41 °C, edema of lids and face is noted. Complications: myocarditis, pneumonia, meningoencephalitis, polyneuritis, thromboembolia, etc.

Diagnosis: the clinical picture of the disease (edema of the lids and the face, muscular pains), taking case history (eating untested meat of pigs, wild boars). *Laboratory investigations:* general blood analysis (eosinophilia) and immunological methods, microscopic investigation of biotates of calves muscles and acromiohumeral muscles.

Prophylaxis: personal — exclusion of untested meat from the diet (thermal preparation of meat does not kill larvae). **Social** — killing rodents being reservoirs of invasion, veterinary control over meat products, zoohygienic keeping of pigs (not allowing them to eat rats), deratization and sanitary-popularization activity.

6. Biological bases of prophylaxis of nematodosis.

It is a complex of prophylactic measures that are based on studying biology of the pathogen, ways of migration, development stages and biology of intermediate hosts, which gives a possibility to interrupt some link of the parasite's development cycle.

Basic terms and concepts:

- 1. Migration ascariasis** — a disease caused by ascarides' larvae.
- 2. Bulbus** — dilation of the esophagus.
- 3. Vesicule** — swelling of a cuticle around the oral opening of a seat worm.
- 4. Geohelminthes** — worms the larvae of which develop in soil.
- 5. Dehelmithization** — a complex of measures to destroy parasitizing worms in the human organism.
- 6. A capsule** is formed by a connective tissue, it protects a trichinella larva from being digested by the host's organism.
- 7. Migration** — movement of a larval stage of ring worms in the human organism.
- 8. Nematodoses** — diseases caused by ring worms.
- 9. Larva migrans** — a syndrome that occurs in migration of larvae of animal ascarides (of pigs, dogs, etc.) in the human organism.
- 10. Muscular tremor** — convulsive trembling of muscles.

CLASSES II

1. Medina.

Dracunculus medinensis — a biohelminth, a pathogen of dracunculosis. Foci of the disease are in Africa, the Near East, South-Western Asia and South America.

Morphological peculiarities: the length of a filament female is 30–150 cm. Viviparous. Larvae come out through ruptures of the uterus and cuticle on the anterior end of the body. The length of a male is 12–29 cm.

Development cycle: a principal host is the human, sometimes dogs and monkeys. Intermediate hosts — are small craw-fish-cyclops. Sexually mature females are localized in subcutaneous adipose cellular tissue of lower extremities. After fertilization larvae develop (microfilaria). A female approaches with its anterior end to the skin surface, where a bladder 2–7 cm in diameter is formed and filled with fluid. Then the bladder bursts out. When water gets into a wound, a medina protrudes its anterior end and produces up to 3 million larvae, while it itself undergoes dissolution. Larvae are swallowed by a cyclop. The human gets infected while drinking water from open reservoirs. In the intestines cyclops are digested, and microfilaria migrate through its wall and by blood and lymphatic vessels into the subcutaneous cellular tissue of lower extremities. They reach their sexual maturation in 10–14 months after infection.

Pathogenic action:

1. *Mechanic* (larvae injure intestinal walls, females — subcutaneous cellular tissue).
2. *Toxic-allergic* (poisoning the organism by waste products and decay of dead parasites).

Characteristic symptoms: erythema, thickening of the skin, pains in the extremities, movement impairment, vesicles and ulcers at the site, where the helminth comes out on surface. When vesicles burst, fever, diarrhea, urticaria and vomiting are noted.

Laboratory diagnosis: is not needed (the parasite is well seen as twisted subcutaneous rollers).

Prophylaxis: personal — usage of unboiled and unfiltered water should be excluded in foci of dracunculosis. **Social** — revealing and treating sick persons, protection of water sources from contamination, sanitary-popularization activity.

2. Duodenal assassin worm.

Ancylostoma duodenale — a geohelminth, a pathogen of ankylostomiasis. The disease is spread in countries with a subtropical and tropical climate.

Morphological peculiarities: a female is 10–13 mm in length, a male — 8–10 mm. There is a funnel-like mouth capsule with 4 cuticular teeth on the head part (fig. 47).

Development cycle: adult forms are localized in the duodenum. After fertilization the female lays eggs that get into the environment with feces. Under optimal conditions in a day, non-infectious (rabdit) larvae come out of eggs in the soil. After several sloughing they transform into infectious (filarial-like) larvae (fig. 48).

Infesting of the human occurs: 1) in active permeation of larvae through the skin, 2) through the mouth with contaminated food and water, 3) intra-uterinely by a hematogenic way through the placenta. Having permeated through the skin larvae accomplish a migration: they are carried to the heart, lungs with blood, pass through alveolar walls and get into the respiratory tract,

ascend to the pharynx, are swallowed and reach the duodenum. If a larva gets to the human organism through the mouth, no migration occurs. In the intestines larvae of an assassin worm transform into sexually mature forms. The life span of sexually mature parasites reaches 5–6 years.

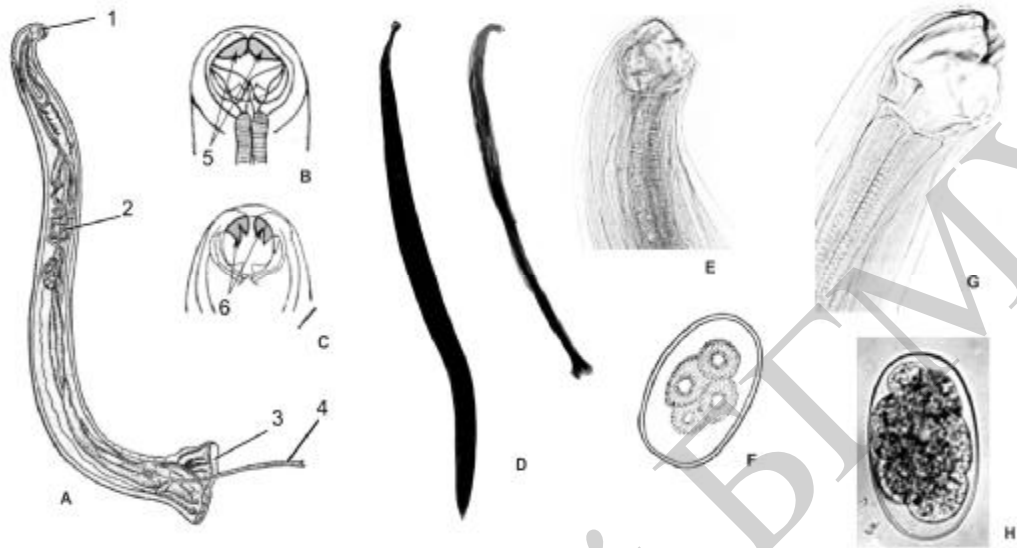

Fig. 47. Morphology of duodenal assassin worms: A–C, F — sketches; D, E, G, H — microphotographs; A, D — sexually mature forms, B, E — a mouth capsule of a necator, C, G — a mouth capsule of an assassin worm: 1 — a mouth capsule; 2 — a testicle; 3 — a sexual bag; 4 — spicules; F, H — an egg

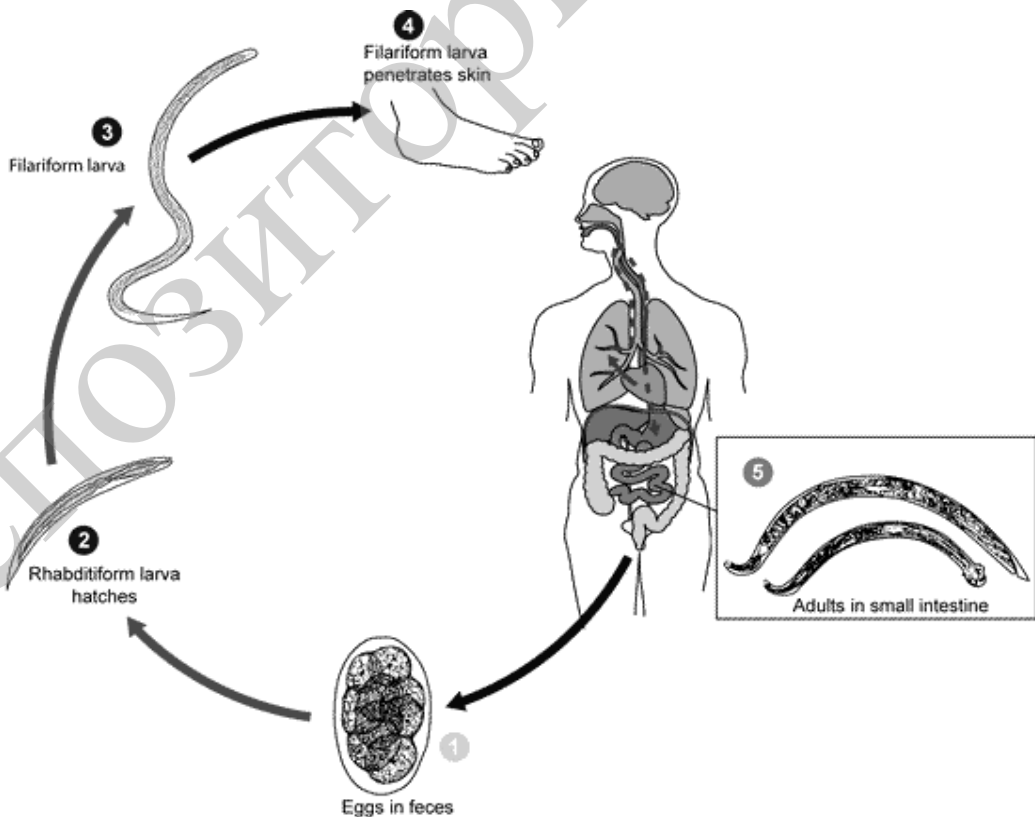

Fig. 48. Life cycle of assassin worms

Pathogenic action:

1. *Mechanic* (rupture of capillaries, injury of alveoli, the mucous membrane of the intestines by larvae, cuticular teeth of sexually mature forms).

2. *Toxic-allergic* (poisoning by waste products).

3. *Feeding on the host's organism* (each assessin worm consumes from 0,36 to 0,7 ml of blood a day) *and impairment of metabolic processes*.

Characteristic symptoms: painfulness at the sites of larvae permeation, later — itching, erythema with red papules, pains in the epygastic area, nausea and diarrhea. Development retardation is noted in children. In a chronic course one can observe edemas, headaches, breathlessness, memory and workability become worse.

Laboratory diagnosis: revealing eggs or larvae in feces.

Prophylaxis: personal — observing rules of hygiene. In foci of ankylostomosis one should not go bare-footed or lie on the ground. **Social** — revealing and treating sick persons, building sanitary facilities in settlements (running water, sewage systems), sanitary-popularization activity.

3. Necator, necator americanus — a geohelminth, a pathogen of necatorosis. The disease is common in tropical and subtropical regions of Asia and South America.

Morphological peculiarities: unlike the assassin worm it has 2 sharp cutting plates in the mouth capsule. **The development cycle, pathogenic action, characteristic symptoms, laboratory diagnosis and prophylaxis** are the same as in ankylostomosis.

4. Dwarf treadworm.

Strongiloides stercoralis — a geohelminth, pathogen of strongyloidosis. The disease is common in the South-East Asia, East and South Africa and South America.

Morphological peculiarities: colorless filament-like nematodas from 1 to 2–3 mm in size.

Development cycle: localization — the duodenum, bile and pancreatic ducts. After fertilization females lay eggs and males die. Rabdit (non-infectious) larvae come out of eggs, which are excreted into the environment with feces. The further development of rabdit larvae goes in soil **in two ways:** 1) if the conditions are unfavorable, they turn into filarial-like (infectious) larvae that actively get into the human skin and migrate around the organism (as assessin worm larvae); 2) if the conditions are favorable, the rabdit larvae transform into free living males and females. After fertilization free living females lay eggs producing rabdit larvae that transform either into sexually mature forms or in filarial-like larvae. There is also a possibility of a development way without leaving the intestines for the environment: after a slough rabdit larvae transform into filarial-like ones in the intestines, accomplish a migration and reach their sexual

maturity. Migrating larvae may transform into sexually mature forms already in the lungs.

Pathogenic action:

1. *Mechanic* (rupture of capillaries, breaking of alveoli by larvae, injury of the mucous membrane of a small intestine).
2. *Toxic-allergic* (poisoning by waste products).
3. *Feeding on the host's organism* (content of the intestines) *and impairment of metabolic processes*.

Characteristic symptoms: skin inflammation, weakness, irritability, headaches, skin itching, symptoms of bronchitis, pneumonia. Then appear signs of enteritis, gastroenteritis. Complications: perforation of the intestines with peritonitis, pancreatitis.

Laboratory diagnosis: revealing rabbit larvae in fresh warm feces, sometimes — in duodenal content, sputum, vomit masses. A high eosinophilia is noted in the blood, it reaching 70–80 %.

Prophylaxis is the same as in ankylostomoses.

5. Filarias.

Filaria — biohelminthes, pathogens of filariatoses, is widely spread in countries with a tropical and subtropical climate.

They have a filamentous shape, localized in tissues and cavities of the human body, and larvae (microfilarias) — in the blood or tissues. Filarias are viviparous. *A final host* is the human and mammals. *Intermediate hosts and carriers* — are 2-winged blood-sucking insects.

Wuchereria bancrofti — a pathogen of wucheriosis.

Morphological peculiarities: a female has a filamentous body of white color 8–10 cm in length, a male — 4 cm.

Development cycle: a principal host is the human, intermediate hosts and transmitters are mosquitoes of g. *Culex*, *Anopheles*, *Aedes* and *Mansonia*. Localization of sexually mature forms is lymphatic vessels and nodes. Females produce larvae that migrate into blood vessels (at day they are in deep vessels of internal organs, at night — in peripheral ones). When a sick person is bitten by a mosquito female, it gets infected with microfilarias. Microfilarias develop in the mosquito organism, and when it bites a human — they migrate into the lymphatic system and reach their sexual maturity (fig. 49).

Pathogenic action:

1. *Mechanic*: obstruction of lymphatic vessels, impairment of the lymphatic off-flow, a sharp increase of the affected organ.
2. *Toxic-allergic action of the parasite's metabolite products*.

Characteristic symptoms: at an early stage — fever, conjunctivitis, enlargement of lymphatic nodes, attacks of bronchial asthma. At the 2nd stage — inflammation of lymphatic nodes and vessels, microfilarias appear in the blood. At the 3rd stage — the presence of lymph in the urine, testicle dropsy, diarrhea

with lymph, elephantiasis of lower extremities, mammary glands, sexual organs.

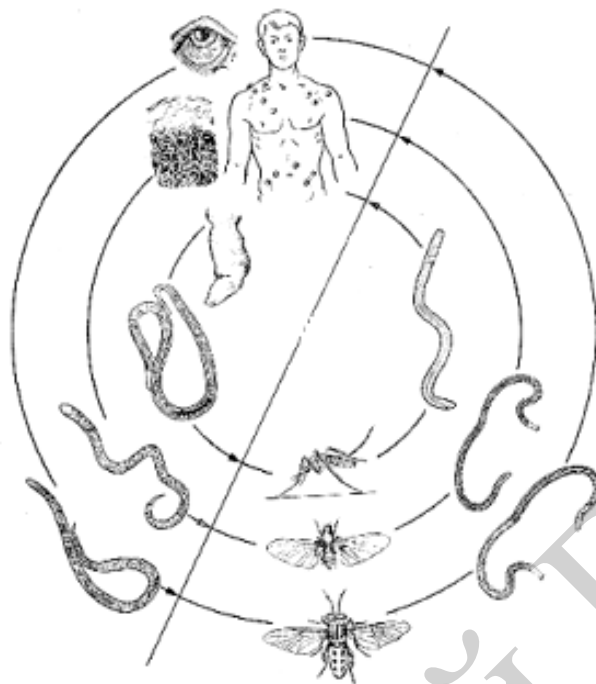

Fig. 49. Diagram of filarial development cycles

Diagnosis: revealing microfilaria in blood.

Prophylaxis: personal — protection from mosquito bites and chemoprophylaxis. **Social:** revealing and treating sick persons, killing transmitters, sanitary-popularization activity.

Brugia malayi — a pathogen of *brugiosis*. The morphology is similar to that of *W. bancrofti*. The life cycle does not differ from the cycle of wuchereria. A final host is the human, monkeys, cats and dogs. Intermediate hosts and transmitters — mosquitoes of g. *Mansonia*. It is extremities that are mainly affected. Pathogenic action, symptoms and diagnosis are the same as in wucheriosis.

Onchocerca volvulus — a pathogen of *onchocercosis*.

Morphological peculiarities: a principal host is the human, an intermediate host and transmitter — midges of g. *Simulium*. Sexually mature forms are localized in the superficial layers of the skin. After fertilization females produce microfilarias that permeate into the skin, eyes and lymphatic nodes. In biting a sick person larvae that become infectious get into the stomach of a midge together with blood. When this midge bites a healthy person, larvae get into the skin, migrate into the subcutaneous adipose cellular tissue, where they reach their sexual maturity.

Pathogenic action:

1. *Toxic-allergic* (poisoning by waste products).
2. *Mechanic* (injury of the skin, lymphatic vessels).

Characteristic symptoms: onchocercotic dermatitis (itching, skin eruptions, its thinning, loss of elasticity, formation of small wrinkles — an «orange skin» or «crocodile skin», «elephant skin», elephantiasis of the face («lion's muzzle»). Complications — eye injuries, loss of vision.

Laboratory diagnosis: revealing microfilarias in section of superficial parts of the skin or of sexually mature forms — in onchocercomes.

Prophylaxis: personal — protection from midges' bites. **Social** — revealing and treating sick persons, killing midges, sanitary-popularization activity.

Loa loa — a pathogen of loaiasis.

Morphological peculiarities: a filamentous body is up to 5 cm in length in females and to 3 cm in males.

Development cycle: a final host is the human, monkeys, an intermediate host and transmitter — horse flies. Localization of sexually mature forms — the subcutaneous cellular tissue, eye serous cavities, while larvae are localized in the circulation system. Larvae (microfilarias) are characterized by a day periodicity of migrations in the human organism. After a horse fly bite microfilarias become infectious in its organism. The human gets infected through a horse fly bite.

Pathogenic action:

1. *Toxic-allergic* (poisoning by waste products).
2. *Mechanic* (injury of tissues).

Characteristic symptoms: pains in the extremities, paresthesia (impairment of sensitivity), edemas, eye affection — edemas and hyperemia of lids, pains, worsening of eye-sight. Abscesses develop as a result of a secondary infection in muscles and lymphatic nodes.

Laboratory diagnosis: revealing microfilarias in smears and in a thick drop of blood. Parasites are seen beneath the conjunctiva.

Prophylaxis: personal — protection from attacks of horse flies. **Social** — revealing and treating sick persons, killing transmitters, sanitary-popularization activity.

6. Diagnostic methods of helminthes.

Macroscopic methods:

1. **Examination of excrements.** Small portions of excrements are mixed with water in a flat bath or a Petri's plate. They are looked through under good illumination on a dark background, if necessary using a magnifying glass. One can reveal integral helminthes, their skolexes, tears of a strobila, proglottids.

2. **Settling method.** Excrements are mixed with water and left in a glass cylinder, then the upper layer of the fluid is pored off. This is repeated several times. After the fluid becomes translucent, it is pored off, and settlings are looked through in a glass bath of a Petri's plate. The method allows to reveal helminthes, their skolexes, scraps of a strobila, proglottids and to diagnose teniasis and teniarynosis.

Microscopic methods:

1. **Native smear.** A small part of excrements is brought by a stick on the object glass into a drop of the 50 % of water-glycerin solution and rubbed until an even smear is obtained, then it is examined under the microscope.

2. **Thick smear with cellophane (Kato's method).** Helminthes eggs are revealed in a thick smear of excrements, lighted by glycerin and stained with malachite green. The method reveals eggs of ascarides, vlasoglavs, diphyllbothria, trematodas, tenias.

3. **Schulman's method.** 2–3 g of excrements are mixed with a 5-fold volume of physiological solution or water with circular motions of a glass stick. Eggs and larvae accumulate in the center. After mixing a drop is carried on the end of the stick to the object glass, it is covered with the cover glass and examined under the microscope. This method reveals larvae of an assassin worm, necator, dwarf treadworm.

4. **Method of a sticky tape** is used for diagnosis of enterobiosis. A piece of translucent polyethylene tape 4–5 cm long is applied with a sticky side across the anus to perineum folds, is taken off at once and is stuck to the object glass. The obtained preparations are studied under the microscope. Investigations are performed in morning hours.

Enrichment methods:

1. **Sedimentation methods:** if the specific weight of eggs is greater than the specific weight of the fluid, then eggs are concentrated in the sediment, which is studied under the microscope. It is used for revealing trematoda eggs.

Goryachev's method is used for diagnosis of opistorchosis.

Krasilnikov's method. Under the action of detergents included in the composition of washing substances helminthes' eggs are concentrated in the sediment. The method allows revealing eggs of all helminthes excreted with excrements.

2. **Floation methods:** if the specific weight of eggs is less than the specific weight of the fluid, then eggs float to the surface of the fluid and then the film is studied. It is used for revealing eggs of assassin worms, vlasoglavs and dwarf tenias.

Fulleborn's method. Saturated solution of NaCl is used. Eggs of nematodas, dwarf tenia and diphyllbothrium float up well.

Kalantaryan's method. Excrements are mixed up with a saturated solution of NaNO₃ in ratio 1:20. Eggs of the majority of helminthes quickly float up and are revealed in a superficial film. Oncosphere of tenias and eggs of trematodas do not float up.

Diagnosis of tissue helminthes. To diagnose tissue helminthes (trichinellosis, cysticercosis and etc.) **immunological methods** are used: a complement linkage reaction (CLR), reaction of an indirect hemagglutination and others.

Muscular biopsy method for diagnosis of trichinellosis: a piece of the acromioclavicular muscle or a calf is taken in aseptic conditions. Under the microscope one can see spiralized larvae of trichinellas in capsules inside muscular fibers.

Method of digesting muscles: finely cut muscles are flooded with gastric juice and placed into the thermostat in 37 °C for 12–16 hours. Then the sediment is put on the object glass with a dropper and studied under the microscope. Trichinella larvae are revealed to be free of capsules.

Method of a blood smear and a thick drop for diagnosis of filariatoses. The blood is taken from a finger mainly at night. Microfilarias are revealed as thin twisted filaments.

Basic terms and concepts:

1. **Dracunculosis** — a disease caused by medinas.
2. **Rabbit larva** — a non-infectious stage of assassin worms.
3. **Filarious larva** — an infectious stage of assassin worms.
4. **Microfilarias** — larvae of filarias parasitizing in the blood or tissues.
5. **Onchocercoma** — a subcutaneous node, where are sexually mature forms of onchocercs.
6. **Tissue helminthes** — diseases caused by parasites localized in tissues and closed cavities.
7. «**Tropical eosinophilia**» — a syndrome that develops at an early stage of wuchereriosis.
8. **Filariatoses** — a group of diseases caused by filarias.
9. **Chyluria** — the presence of pus in the urine.
10. **Elephantiasis** — impairment of the off-flow of lymph and «overgrowing» of the organ.

PHYLUM ARTHROPODA, CLASS ARACHNOIDEA

1. General characteristic and systematization of the Arthropoda phylum (Arthropoda).

The number of species is over 1,5 million. **Characteristic features:** 1) development of organ systems from 3 germinal layers; 2) bilateral symmetry of the body; 3) heteronomous segmentation; 4) 2 departments (the head-breast and the abdomen) or 3 (the head, the breast and the abdomen); 5) segmental extremities; chitinized cuticle (an external skeleton); 7) appearance of striated muscles and separation of muscular groups; 8) mixocoel; 9) development of the circulatory, respiratory, digestive, excretory, nervous and genital systems of organs.

The digestive system consists of 3 departments: anterior, middle and posterior. It starts with an oral and ends with an anal opening. A complex oral apparatus is developed. There are digestive glands in the middle department. *Ex-*

cretory organs — are modified metanephridia (green and coxal glands) and Malpighian vessels. *Respiratory organs* — branchia, pulmonary sacs and trachea. The circulatory system is not locked. The heart is located on the dorsal side. *The nervous system*: a large supratharyngeal ganglion performing the function of the brain, a peripharyngeal nervous ring and an abdominal nervous chain. *Sense organs* are developed (tactile, olfactory, gustatory, vision and hearing). Arthropoda have separate sexes (with a complete and incomplete metamorphosis).

Classes: Crustacea, Arachnoidea and Insecta.

2. General characteristic and systematization of the Arachnoidea class (Arachnoidea).

The number of species is about 40 000. They adapted for living on the ground. They have 2 departments of the body — the head-breast and the abdomen. The body is covered with a chitinized cuticle, the hypoderm is located beneath it. Derivatives of the hypoderm — webbed and venomous glands. 6 pairs of extremities are located on the breast. The first 2 pairs (cheliceres and pedipalpa) are to grasp and fragmentize food. The rest 4 pairs — are walking limbs. The *digestive system* is adapted for eating semi-fluid food. *The excretory system*: coxal glands and Malpighian vessels. *Respiratory organs*: pulmonary sacs and trachea. The circulatory system has a very complex structure in scorpions and spiders, whose respiratory organs are pulmonary sacs. There is a tube-like heart with orifices — *ostia* (3–7 pairs), 2 short aortas (anterior and posterior) and per a pair of lateral arteries branching off from each heart chamber. The hemolymph contains *hemocyanin*. The head ganglion performs functions of «the brain». The nervous chain is characterized by concentration of ganglia. Sense organs (vision, tactile, olfaction and taste) are well developed. Arachnoidea have *separate sexes*. Dimorphism is marked. The reproduction is sexual, the development is direct and indirect.

Orders: scorpions (Scorpiones), spiders (Aranei), ticks (Acarina).

3. Ixodous, argasal and gamasal ticks. Order of Acari — ticks. Family of Ixodae — ixodous ticks.

Representatives: *Ixodes ricinus* — a dog's tick, *Ixodes persulcatus* — a Russian spring-summer tick, *Dermacentor pictus*, *Dermacentor marginatus*.

Morphological peculiarities: the body sizes are from 5 to 25 mm. They inhabit open spaces (forests). The body has no departments. There are 4 pairs of walking limbs. The first 2 pairs of limbs form the oral apparatus of a stabbing-sucking type — «head». The head is located terminally on the anterior end of the body and is seen from the dorsal side. There is a chitin corselet that covers the whole dorsal part in the male, in the female — only the frontal part, which provides a greater resilience of the abdomen in blood sucking. In ticks of *Ixodes* genus the corselet is dark-brown; in ticks of *Dermacentor* genus it has a marble pattern. There are eyes (fig. 50).

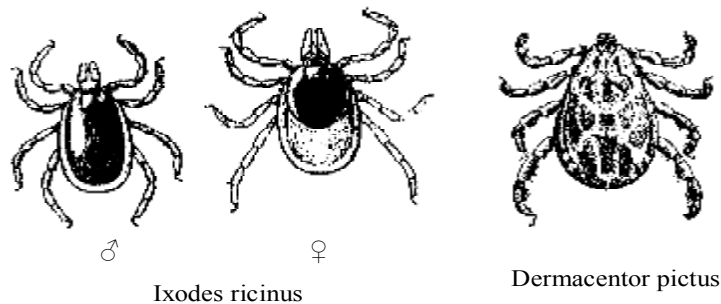

Fig. 50. Ticks of Ixodae family

Peculiarities of biology. Blood sucking lasts up to several days. They can fast up to 3 years. Their bites are painless, the saliva contains anesthetics. The female lays about 17 000 eggs in soil fissures, bark of dead trees. **Development stages:** an egg – a 6-legged larva – several stages of nymphs – an imago. Blood sucking occurs at every stage.

Medical significance: they are specific pathogen transmitters of a Russian spring-summer encephalitis. The virus of encephalitis affects salivary glands and gonads of ticks; transmission of pathogens is possible in blood sucking and transovarially. Reservoirs of an encephalitis virus — birds, wild rodents. Ixodous ticks transmit hemorrhagic fevers, brucellosis, tick enteric fever, they support foci of plague and tularemia. Ticks of Dermacentor genus transmit a pathogen of a Scotch encephalitis.

Family of Argasidae — argasal ticks.

Representatives: Ornithodoros papillipes, Argas persicus.

Morphological peculiarities: the body sizes of a tick are from 2 to 30 mm. A chitin corselet is absent. The «head» is not seen from the dorsal side. There is a marginal welt. Vision organs are absent (fig. 51).

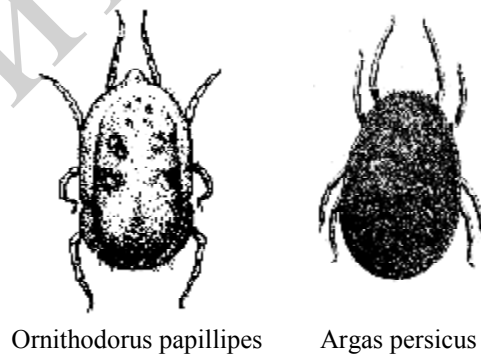

Fig. 51. Ticks of Argasidae family

Peculiarities of biology: argasal ticks — sheltic forms (caves, holes of rodents, abandoned buildings). Blood sucking lasts to about 50 minutes. They can fast up to 12–15 years. Egg-laying contains 50–200 eggs. There are several stages of nymphs. Transovarial transmission of pathogens is possible.

Medical significance: they are specific transmitters of a tick recurrent fever (tick spirochetosis). Natural reservoirs of the pathogen — cats, dogs and wild rodents. The saliva of ticks has a toxic action, and at bite sites ulcers may develop.

Gamasidae family — gamasal ticks.

Representative: *Dermanissus gallinae* — a hen's tick.

Morphological peculiarities: Body sizes are 0,2–0,3 mm. The body is covered with bristles. Eyes are absent.

Peculiarities of biology: females feed on blood, there is a gonotrophic cycle; they inhabit holes of rodents, birds' nests. From pigeons' nests they can get to human dwellings through ventilation pipes.

Medical significance: they are permanent or temporary ectoparasites. The saliva of ticks is poisonous and causes dermatitis. When they get into respiratory ways, they cause asthmatic symptoms. Transmit pathogens of tick spirochetosis, encephalitis, hemorrhagic fevers. May transmit pathogens of the plague and tularemia.

Fighting measures against ticks: wearing special clothes, using repellents, examination of the clothes and the body to remove ticks after going to the forest; use of acaricides, killing rodents (hosts — feeders).

4. Sarcoptic and tyroglyphic ticks. Tyroglyphidae family — tyroglyphic ticks.

Representative: *Tyroglyphus farinae* — a flour tick.

Morphological peculiarities: they are small (0,4–0,7 mm), have no eyes, the body is of a light-yellow color and egg-shaped.

The place of inhabitation is soil, decaying wood, birds' nests, rodents' holes. Birds and insects transmit ticks. They may inhabit food stores (flour, groats, corn, cheese, etc.), spoil them contaminating with their excretions; affect corn in granaries.

Medical significance: while eating contaminated food one may have catarrhal symptoms of the gastric-intestinal tract. During harvesting and threshing the corn, ticks get into respiratory ways causing asthmatic symptoms, or if it is the skin — dermatitis (grain scabby).

Sarcoptidae family — sarcoptic ticks.

Representative: *Sarcoptes scabiei* — a scabby tick.

Morphological peculiarities: the sizes are 0,3–0,4 mm. Legs are shortened, of a conical shape; the body is broad, oval, of a yellow color, is covered with bristles, eyes are absent. It breathes with the surface of the whole body.

Development cycle: they are permanent hyperdermal parasites of the human and animals. A tick's female gnaws passages in the thickness of the corneous layer of the skin per 2 mm a day. Males do not make any passages. Ticks feed on the host's tissues. After fertilization, the female lays about 50 eggs. The development from an egg to an imago takes about 1–2 weeks. Adult ticks

live up to 2 months. Infection occurs in a direct contact with a sick person or their things, where may be ticks.

Medical significance: they cause scabby, affect the skin of the hand back side of interdigital spaces and flexor surfaces of joints. Ticks cause a severe itching, becoming worse at night. Secondary infection gets in scratches causing suppuration. Ticks of dogs, horses, pigs and other animals may parasitize on the human.

Prophylaxis of scabby: following hygienic rules in dealing with animals and sick people, neatness of the body, linen and dwelling; revealing and treating sick persons, sanitary supervision over hostels, baths, sanitary-popularization activity.

5. The study of E. N. Pavlovsky about the natural origin of foci of transmissible diseases. Characteristic of a natural focus.

The diseases are **transmissible**, if their pathogens are transmitted through blood by a transmitter — an Arthropoda (ticks and insects).

Transmission of a pathogen by a transmitter occurs in blood sucking through a proboscis (*inoculation*), through coverings of the host contaminated by transmitter's excrements containing pathogens (*contamination*), through eggs in sexual reproduction (*transovarially*). Pathogens undergo definite development stages in the organism of specific transmitters (malaria plasmodia in a female of a malaria mosquito). Mechanic transmitters (flies, cockroaches) transmit pathogens on body coverings, on parts of the oral apparatus.

In an obligate-transmissible disease the pathogen is transmitted only by a transmitter (leishmanioses). *Facultative-transmissible diseases* (the plague, tularemia, anthrax) are transmitted through a transmitter and in other ways (through respiratory organs, foods of animal origin).

A transmissible disease is characterized by the presence of: 1) parasite — a pathogen; 2) a vertebrate — a host; 3) an arthropoda — a transmitter.

The natural focus and its structure. In 1940 E. N. Pavlovsky formulated a **study about natural foci of diseases**. A natural focus is a definite geographic landscape, where circulation of the pathogen from a donor to a recipient occurs through a transmitter. *Donors of a pathogen* — are sick animals, *recipients of a pathogen* — are healthy animals, which after getting infected become donors.

Basic terms and concepts:

1. Pedipalps and cheliceres — are the 1st and 2nd pair of modified extremities of the oral apparatus of Arachnida that serve for grasping and fragmentizing food.

2. Mechanic transmitter — is a transmitter, who carries pathogens on body coverings.

3. Specific transmitter — is a transmitter, inside which the pathogen undergoes its development.

4. Natural focus — is a definite geographic landscape, where the circulation of a pathogen occurs from a donor to a recipient through a transmitter without human assistance.

5. Transovarial transmission of a pathogen — is the transmission of a pathogen through eggs.

PHYLUM ARTHROPODA, CLASS INSECTA, ORDER DIPTERA

CLASSES I

1. General characteristic and systematization of Insecta class.

The number of species is over 1 million. There are 3 body departments: head, a breast and an abdomen. There are 2 pair of feelers (sense organs), an oral apparatus and a pair of eyes on the head. The thoracic department consists of three segments bearing per one pair of walking legs. In many of them on the 2nd and 3rd segments from the dorsal side are 1 or 2 pairs of wings. The abdomen consists of 6–12 segments. The body is covered with chitin, beneath is the hypoderm containing odorous, waxy and sloughing glands. *The muscular system* is differentiated and specialized. *The digestive system* consists of an anterior, middle and posterior departments. A complex oral apparatus contains upper jaws, lower jaws, a lower lip, an upper lip and a tongue (hypopharynx). Types of the oral apparatus: gnawing (bugs), stabbing-sucking (mosquitoes, fleas), licking (flies), sucking (butterflies). *The excretory system*: Malpighian vessels and a fat body (accumulation bud). *Respiratory organs* — trachea. *The circulatory system* is poorly developed. A multichamber tube-like heart and a branching off aorta are located on the dorsal side. The hemolymph transports nutrients and dissimilation products. The nervous system consists of «the brain» (a head ganglion) represented by 3 departments — anterior, middle and posterior. An abdominal nervous chain has a tendency to confluence of ganglia. *Tactile organs* — sensitive hairs scattered around the body. *Olfactory organs* are located on feelers and antennae on lower jaws. Taste receptors are on oral extremities and on paw segments. Eyes are simple or complex (faceted). The insects have separate sexes, a sexual dimorphism is marked. The reproduction is sexual. The development is direct or indirect (with a complete or incomplete metamorphosis). The following criteria were used for the division into classes: a type of the oral apparatus, the presence and the number of wings and the type of development (tab. 4).

Medical significance: they are pathogens transmitters of transmissible diseases, pathogens of diseases (larvae of flies, fleas), ectoparasites and venomous animals.

Orders of insects

Order	Metamorphosis	Wings structure	Oral apparatus
Bugs	Incomplete	2 pairs: front wings are semi-hard, on tops — membranous, the 2 nd pair — membranous	Stabbing-sucking
Cockroaches	Incomplete	2 pairs: cutaneous overwings and thin membranous back w	Gnawing
Lice	Incomplete	Are absent	Stabbing-sucking
Fleas	Complete	Are absent	Stabbing-sucking
2 winged	Complete	The front paire of wings — membra-neous, are narrowed at the base, the back pair is reduced and transformed into halteres	Stabbing-sucking, licking-sucking

2. Order of Lice (Anoplura).

Representatives: genus of *Pediculus* and genus of *Phthirus*. The *Pediculus* genus is represented by one species of *Pediculus humanus* including 2 subspecies — a head louse and a body louse who freely cross and give fertile fillies, though they have some morphological and biological differences.

Head louse (*Pediculus humanus capitis*).

Morphological peculiarities: the length of a male is 2–3 mm, of a female — 3–4 mm. The posterior end of the male's body is rounded, of the female's — is forked. The oral apparatus is of a stabbing-sucking type (fig. 52).

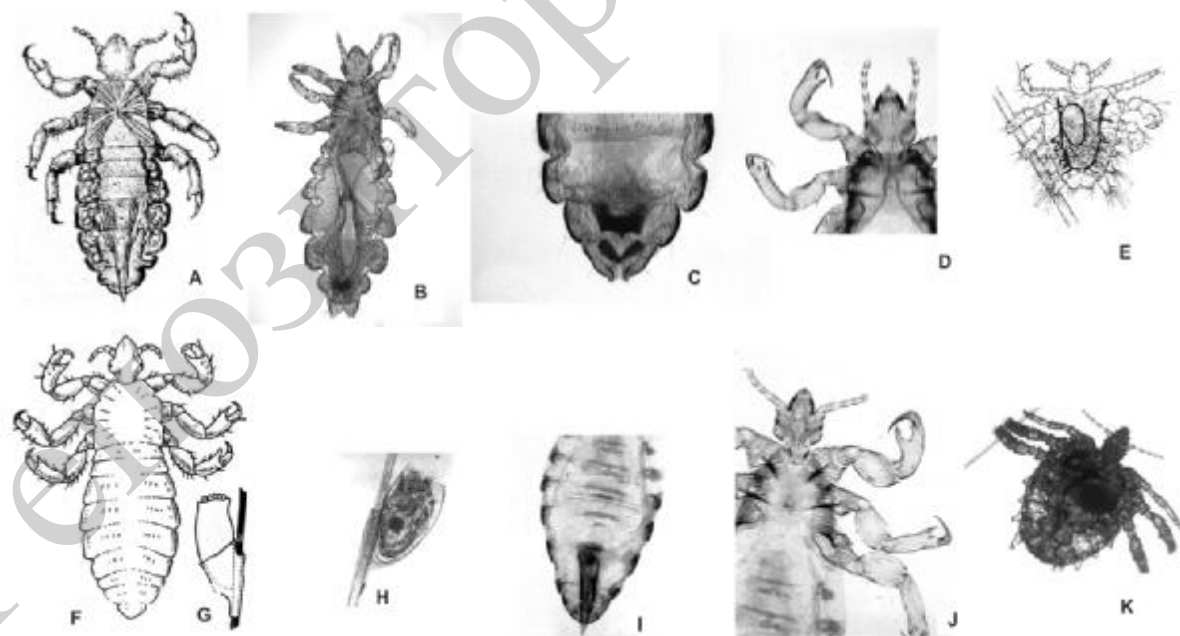

Fig. 52. Representatives of the Lice order:

A — *Pediculus humanus capitis* (a sketch); B, C, D — *Pediculus humanus capitis* (7×8); F — *Pediculus humanus humanus* (a sketch); G, H — nits; I, J — *Pediculus humanus humanus* (7×8); E — *Phthirus pubis* (a sketch); K — *Phthirus pubis* (7×8)

Development cycle: lives in the hairy area of the head. Feeds on human blood 2–3 times a day, may fast for some days. Eggs (nits) stick to hairs with a sticky secrete. During the whole life (about 38 days) a female lays about 300 eggs. A larva comes from an egg that in several days transforms into an imago (a sexually mature form).

Body louse (*Pediculus humanus humanus*).

Morphological peculiarities: has larger body sizes than a head louse (to 4,7 mm), carvings along the body edge are not so deep and pigmentation is slightly marked. **Development cycle:** lives on underwear and linen, but feeds on the skin. Nits stick themselves to hairs of the clothes. The life span is up to 48 days, the development cycle is no less than 16 days. By the end of its life the female can have about 4000 fillies.

Medical significance: lice of g. *Pediculus* cause pediculosis (a disease of tramps). Feeding on blood lice introduce saliva into the wound that causes itching in the human. Pediculosis is characterized by pigmentation and hardening of the skin. Lice are specific pathogens transmitters of a louse-born relapsing and a louse-born enteric fever. Getting infected with a louse-borne relapsing fever (pathogens — Obermeier's *Spirochaeta*) occurs by a specific contamination (while squashing it and rubbing its hemolymph into the skin during scratching). Getting infected with louse-borne enteric fever (pathogens — Provachek's rickettsia) occurs by *contamination* (in rubbing lice's feces into the skin or by a *specific contamination* (in squashing a louse the content of its intestine gets into bites wounds or into scratches on the skin).

Pubic louse (*Phthirus pubis*).

Morphological peculiarities: sizes up to 1,5 mm. The body is short, broad, trapeziform. **Life cycle:** parasitizes on the body parts covered with thin hard hair: on the pubis, in armpits, on brows and eye-lashes, in the beard. The female lays about 50 eggs during its life. The life cycle duration (from an egg to a sexually mature form that starts laying eggs) — 22–27 days. **Medical significance:** Causes phthiriosis (severe itching and hardening of the skin). Getting infected occurs in sexual contacts, rarely — through underwear and linen.

Fighting against lice: killing them in the environment, on the human body and on clothes.

3. Order of Fleas (*Aphaniptera*).

Morphologicval peculiarities: the body is flattened from the sides, a hard chitin covering, wings are absent. There are multiple hairs, bristles, small teeth on the body surface. There are short feelers and a pair of simple eyes on the head. The last pair of legs is longer than all the rest and serves for leaping. The oral apparatus is of a stabbing-sucking type. The life cycle lasts about 19 days. Fleas lay eggs in slits of the floor, in dry garbage. Development is accompanied with a complete metamorphosis. Larvae have a worm-like shape without limbs. In some time a larva pupates. An imago feeds on warm blood,

a larva — on organic leftovers. The life span of fleas may be over 1 year. **Representatives:** human fleas (*Pulex irritans*) and rats' fleas (*Ceratophyllus fasciatus* and *Xenopsylla cheopis*) (fig. 53).

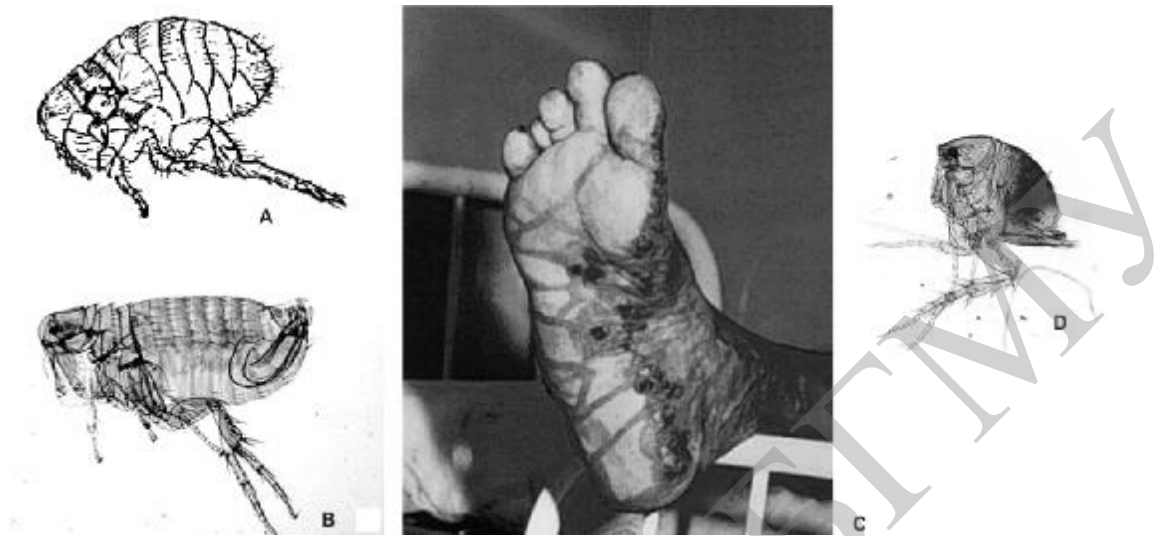

Fig. 53. Morphology of fleas:

A — *Pulex irritans* (a sketch); *B* — *Pulex irritans* (7×8); *C* — affected extremity in sarcopsyllosis; *D* — *Sarcopsylla penetrans* (7×8)

Medical significance: they are temporary ectoparasites (bites cause itching, dermatitis). Specific transmitters of the plague and tularemia pathogens. Natural reservoirs of the plague — rodents (rats, gophers and marmots). The human gets infected with the plague during contacts with a sick animal (taking off skins) or with a sick person (an air-drop way) and transmissively. Infection occurs on blood-sucking (*inoculation*). Infection is also possible in contamination: when the plague bacilli with fleas' feces get on the skin injured during scratching. Fleas of g. *Oropsylla* and *Xenopsylla* also transmit tularemia and rat's enteric fever, they are intermediate hosts of rats' and dogs' tenias.

Chigger flea (*Sarcopsylla penetrans*).

It is common in countries of South America and Africa, lives in sand, in dry grass and in shacks. **Morphological peculiarities:** it is 1 mm long, has a yellowish-grey color. **Life cycle:** Fertilized females are on the surface of the soil. They attack the human, get into the skin between toes or under nails. They feed on blood and lymph, which results in the development of some thousands eggs and enlargement of a flea to the sizes of a pea. There is marked a tumor-like tissue growth around such a flea. Mature eggs are excreted into the environment, the female dies and tears away together with injured tissues.

Medical significance: It is a parasite of the human and mammals (dogs, pigs and rodents), causes sarcopsyllosis. The formed wounds get inflamed and are very painful; often a secondary infection follows. Complications of sarcopsyllosis — gangrene and tetanus.

Fighting against fleas — keeping the rooms neat, wet cleaning, elimination of slits in the floor and walls, fighting against rodents (deratization), using insecticides and repellents. In countries of Africa and South America one should not walk on the ground bare-footed.

4. Order of cockroaches (Blattoidea).

Morphological peculiarities: large insects, the body length reaches 3 cm. The body is flattened in a dorsal-ventral direction. They have 2 pairs of wings: upper are cutaneous, lower are thin, membranous. In females the wings are reduced. The oral apparatus is of a gnawing type (fig. 54).

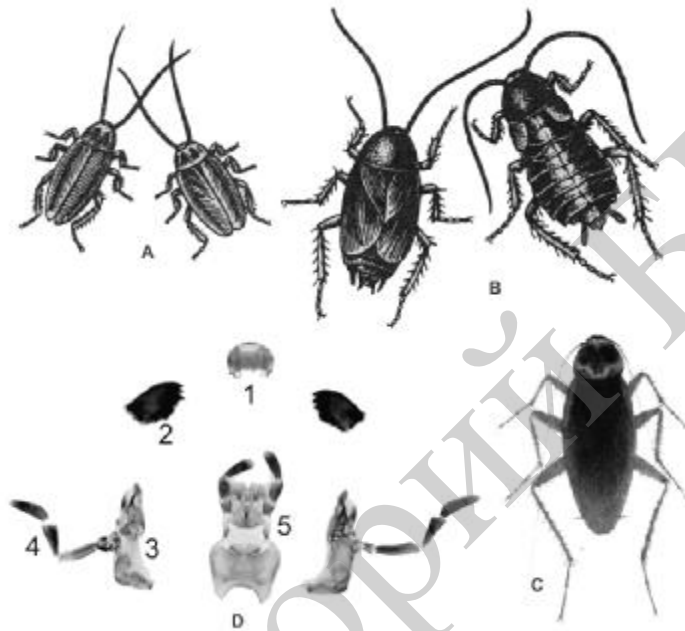

Fig. 54. Morphology of cockroaches:

A — *Blattella germanica*; B — *Blatta orientalis*; C — *Periplaneta americana*; D — oral organs of a black cockroach: 1 — an upper lip; 2 — an upper jaw; 3 — a lower jaw; 4 — mandibular probes; 5 — a lower lip

Life cycle: the development with an incomplete transformation lasts for several months. Females lay eggs in cocoons, which they carry about them 14–15 days. They are active at night, at day they hide in slots. They are met in human dwellings, at food production and public catering enterprises, in shops and canteens. Obligatory conditions for their existence in human dwellings: the presence of fluid, a definite temperature, sufficient amount of food. They feed on foods, human excretions and various wastes.

Representatives: a black cockroach or a kitchen cockroach (*Blatta orientalis*), a red or Prussian cockroach (*Blattella germanica*) and an American cockroach (*Periplaneta americana*).

Medical significance: mechanic pathogens transmitters of infectious and invasive diseases.

To fight cockroaches — insecticides, borax baits, ecological methods are used (one should not water flowers before night, to leave leftovers on the table, it is necessary to clean the room, to close up slots in the floor).

5. Order of Bugs (Heteroptera).

Bed bug (*Cimex lectularius*). **Morphological peculiarities:** their sizes are up to 8 mm (males are less than females), wings are reduced (fig. 55).

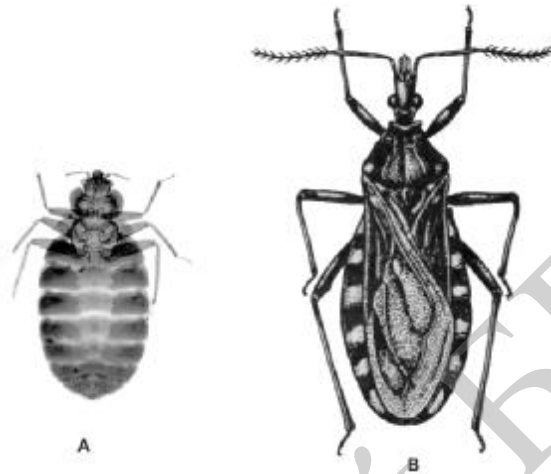

Fig. 55. Morphology of bugs:
A — *Cimex lectularius*; B — *Triatoma infestans*

A chitinous cover is of a dark-brown-red color. It has a specific smell excreted by odorous glands. The body is flattened in a dorsal-ventral direction. The abdomen shape changes from elongated-oval to round, depending on blood saturation.

Life cycle: at day and under artificial illumination bugs hide in slots of the floor, behind plinths, under wall-paper, in furniture grooves, behind the curtains. At night they appear from their shelter, attack the human and feed on blood. Females lay eggs in slots of the floor, books, on linen. In 2–3 weeks (depending on the temperature) larvae come out of eggs, which also feed on blood. Larvae slough several times and transform into imago. Mature bugs and larvae may fast long (for several months).

Medical significance: the saliva of a bug is poisonous and its bites are painful.

Kissing bug (*Triatoma infestans*).

Morphological peculiarities: large sizes (1,5–3,5 cm), an oval flattened in a dorsal-ventral direction body and well developed wings. **Peculiarities of biology:** inhabit rodents' holes, mud-houses and shacks of humans. At night they attack sleeping people and introduce their proboscis into the skin of the neck, face (more often around lips). Having satiated with blood, the bug turns around and defecates into the bite wound or a site of scratches.

Medical significance: a temporal ectoparasite and specific pathogens transmitter of American tripanosomosis (Chaggas disease) — a natural-focal

disease common in South America. In some people bugs' saliva causes a severe allergic reaction.

To fight against bugs insecticides are used, rodents are combated, as they are feeders of bugs, hygienic rules are observed.

Basic terms and concepts:

1. Inoculation — infecting the host through the transmitter's oral apparatus during blood sucking.

2. Insecticides — substances used against insects.

3. Contamination — infecting the host while rubbing transmitter's excrements in during scratching of bite sites.

4. Pediculosis — a disease caused by lice of g. *Pediculus*.

5. Phthiriosis — a disease caused by a pubic louse.

CLASSES II

1. Peculiarities of morphology and biology of Diptera order representatives.

They have one (anterior) pair of membranous translucent wings. The posterior pair transformed into halteres performing the function of an equilibrium organ. A large head is connected with a thoracic department with a thin stem that supports its mobility. Big facetious eyes are located on the head. The oral apparatus is licking, sucking or stabbing-sucking. They feed on blood and plants juices. The development goes with a complete metamorphosis.

2. Components of winged blood-sucking insects (midges, greases, mosquitoes, horse-flies).

Midges (*Simuliidae* family) resemble small flies (sizes of 2–3 mm). They live in damp wooded areas. Their development occurs in water, where females lay eggs on underwater stones and plants. Larvae develop in running water. Females feed on blood, attack animals and humans at day time in the open air. The saliva is toxic, bites are painful. Midges are mechanic pathogens transmitters of tularemia, anthrax, leper, are intermediate hosts and specific transmitters of onchocercosis.

Greases (*Ceratopogonidae* family) have sizes of 1–2,5 mm. They differ from midges as they have a more slender body, a comparatively long proboscis and longer legs (fig. 56). Are common everywhere. Only females feed on blood, they attack animals and humans in twilight (in the morning and in the evening). Larvae and crysalices develop in damp soil, forest litter, in small stagnant water reservoirs. Greases — are mechanic pathogens transmitters of tularemia, are intermediate hosts and specific transmitters of filariatosis.

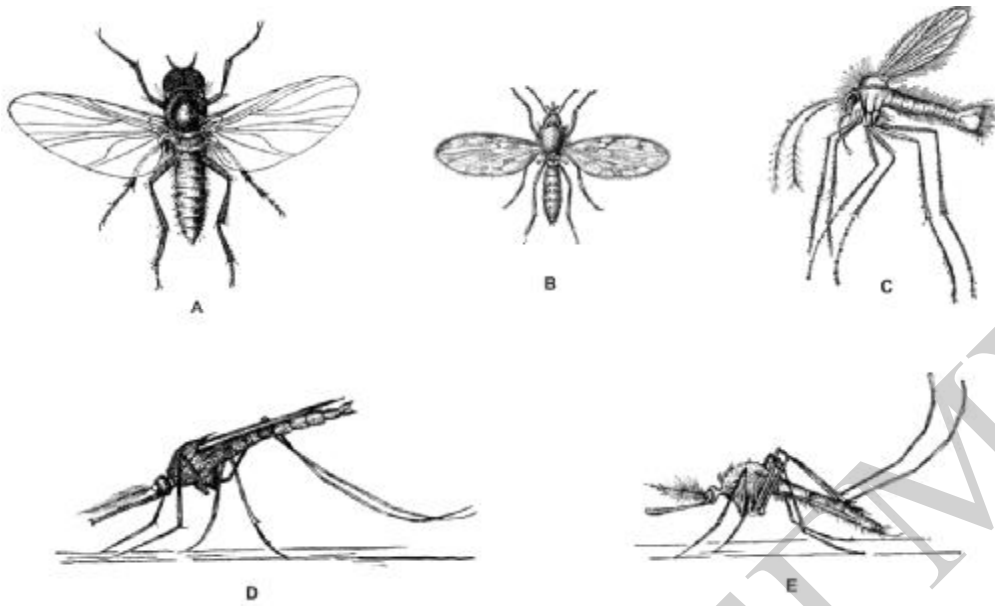

Fig. 56. Morphology of representatives of winged blood-sucking insects: *A* — a midge (Simuliidae); *B* — a gnat (Ceratomyzidae); *C* — a mosquito (Phlebotomidae); *D* — a gnat of g. *Anopheles*; *E* — a gnat of g. *Culex*

Mosquitoes (Phlebotomidae subfamily) inhabit countries with a warm climate, keep close to human dwellings. Besides they live in caves, rodents' holes, etc. Their sizes are 1,5–3,5 mm, coloration is brown-grey or light-yellow. The head is small. The oral apparatus is stabbing-sucking. Legs are long and thin. The body and wings are edged with fur. They lay eggs in protected from the sun places: rodents' holes, caves, tree hollows, in birds' nests, in garbage. Males feed on juices of plants, females — on blood (in twilight and at night). Bites are painful, blisters and itching appear at bite sites. Mosquitoes are specific transmitters of leishmaniasis and pappatachi fever. Transovarial transmission is characteristic of them.

Horse-flies (Tabanidae family) resemble big flies (their body length is up to 3 cm). They live in a forest and steppe zone. Males feed on plants' juices. Females have a stabbing-sucking oral apparatus and feed on blood of animals and humans. They attack more often in hot weather on pastures or near water reservoirs. They lay eggs (from 200 to 1000) on leaves of plants at river-sides. Larvae develop in silt on the bottom of water reservoirs or in damp soil. The saliva is toxic, bites are painful and cause itching. They are mechanic pathogens transmitters of tularemia, anthrax and poliomyelitis, are intermediate hosts and specific transmitters of loiasis.

Fighting measures with winged blood-sucking insects: treatment of living houses with insecticides, putting nets on windows and using repellents.

3. Gnats of *Culex*, *Anopheles* and *Aedes* genera.

Gnats (Culicidae family). There are often met gnats of three genera — *Anopheles*, *Culex* and *Aedes*.

Morphological peculiarities: mature gnats have a slender stretched body of small sizes. There are large facetious eyes, feelers and an oral apparatus on the head. Females have a stabbing-sucking oral apparatus and feed on blood. In males the oral apparatus is sucking. They feed on flowers nectar. Segmented feelers are on the sides of the oral apparatus. A pair of translucent wings is attached to the breast. The abdomen has 10 segments, the last two of them are modified into sexual appendices (fig. 57).

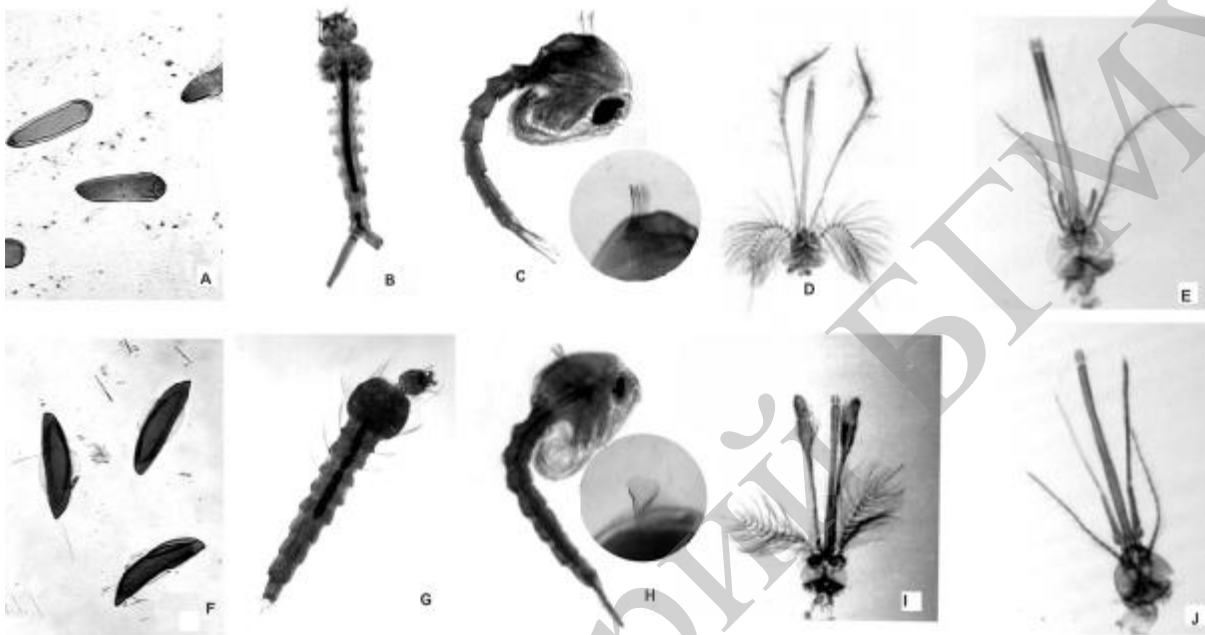

Fig. 57. Morphology of gnats:

A — gnat's eggs of *Culex* genus; *B* — a larva of *Culex*; *C* — a chrysalis of *Culex*; *D* — the head of a male of *Culex*; *E* — the head of a *Culex* female; *F* — gnat's eggs of g. *Anopheles*; *G* — a larva of *Anopheles*; *H* — a chrysalis of *Anopheles*; *I* — the head of an *Anopheles* male; *J* — the head of an *Anopheles* female

Biology of gnats. A new generation of gnats undergoes a period of physiological maturation lasting about 4 days. During this time they are near water reservoirs and feed on nectar. Then in twilight males form a swarm, females fly into it, crossing occurs, after which females must obligatorily drink some blood for eggs to develop. During digesting blood maturation of eggs occurs (**a gonotrophic cycle**). After the eggs have matured, the female flies to a water reservoir and lays eggs (350–450) on its surface. Larvae come out of eggs. A minimum term of development is 15 days in an optimal temperature (25 °C). In the majority of species of gnats (g. *Anopheles* and *Culex*) fertilized females and in species of g. *Aedes* — eggs are wintering. When autumn colds come males fertilize females and die.

Eggs. Gnats of *Anopheles* lay eggs in stagnant or slowly running waters with clean water. Eggs have a belt with air chambers and swim separately. Gnats of *Aedes* lay eggs by one into temporary reservoirs: in puddles, tins, tree hol-

lows. Eggs without air chambers have an oval stretched shape. Eggs of *Culex* without air chambers have a wedge shape and are laid on the surface of water stuck in a form of a boat.

Larvae. Larvae of *Culex* and *Aedes* gnats have a respiratory siphon on the last but one segment. Larvae form an angle with the water surface. Larvae of *Anopheles* gnats have no siphon and are located parallel to the water surface.

Chrysalises. Chrysalises have a comma shape. On the dorsal side of the head-breast is a pair of respiratory siphons. With their aid chrysalises «get hung» to a superficial film of the water. In gnats of *Culex* and *Aedes* siphons have a cylinder shape, in *Anopheles* they are funnel-like (conic).

Mature forms (imago) are distinguished by their seat, pattern of wings and structure of head appendices. In gnats of *Culex* and *Aedes* the abdomen is located parallel to the surface where they sit, in gnats of *Anopheles* — a posterior end of the abdomen is elevated. There are dark spots on the wings of malaria gnats, in non-malaria gnats they are absent. Feelers on males' heads are edged with thick fur, in females their fur is thin. In females of *Anopheles* mandible probes are equal in length to the proboscis, and in females of *Culex* and *Aedes* they comprise $\frac{1}{3}$ – $\frac{1}{4}$ of the proboscis length. In males of *Anopheles* mandible probes are equal in length to the proboscis and have mace-like thickenings, in non-malaria gnats they are usually longer than the proboscis and have no thickenings.

Medical significance: Gnats are temporary ectoparasites. Gnats of *Anopheles* are specific transmitters and final hosts of malaria pathogens, specific transmitters and intermediate hosts of wuchereria and brugia. Gnats of *Aedes* are specific pathogens transmitters of Japanese encephalitis, yellow fever, Dengue fever, lymphocytic choriomeningitis, anthrax, wuchereriosis, bruggiosis, tularemia. Gnats of *Culex* — are specific pathogens transmitters of Japanese encephalitis, tularemia and wuchereriosis.

4. Flies family (Muscidae).

Filth fly (*Musca domestica*) is common everywhere. Females' sizes are up to 7,5 mm. The body and paws are of a dark color, are covered with hairs (fig. 58).

There are claws and sticky cushions on the paws, due to them flies move on any planes. The oral apparatus is licking-sucking. The saliva contains enzymes diluting hard organic substances which it licks off later. They feed on foods and decaying organic leftovers.

Life cycle: in 4–8 days after crossing, in the temperature not lower than 17–18 °C the female lays up to 150 eggs in decaying organic leftovers, refuse, manure, human feces. In the temperature of 35–45 °C larvae come out of eggs in a day, they pupate in soil in 1–2 weeks in the temperature not higher than 25 °C. A new generation of flies appears in a month. Their life span is about 1 month. **Medical significance:** they are mechanic transmitters of enteric infec-

tions (cholera, paratyphus, dysentery, enteric fever), tuberculosis, diphtheria, helminthes eggs and protists cysts. There are up to 6 million bacteria on the fly's body, and up to 28 million in the intestine.

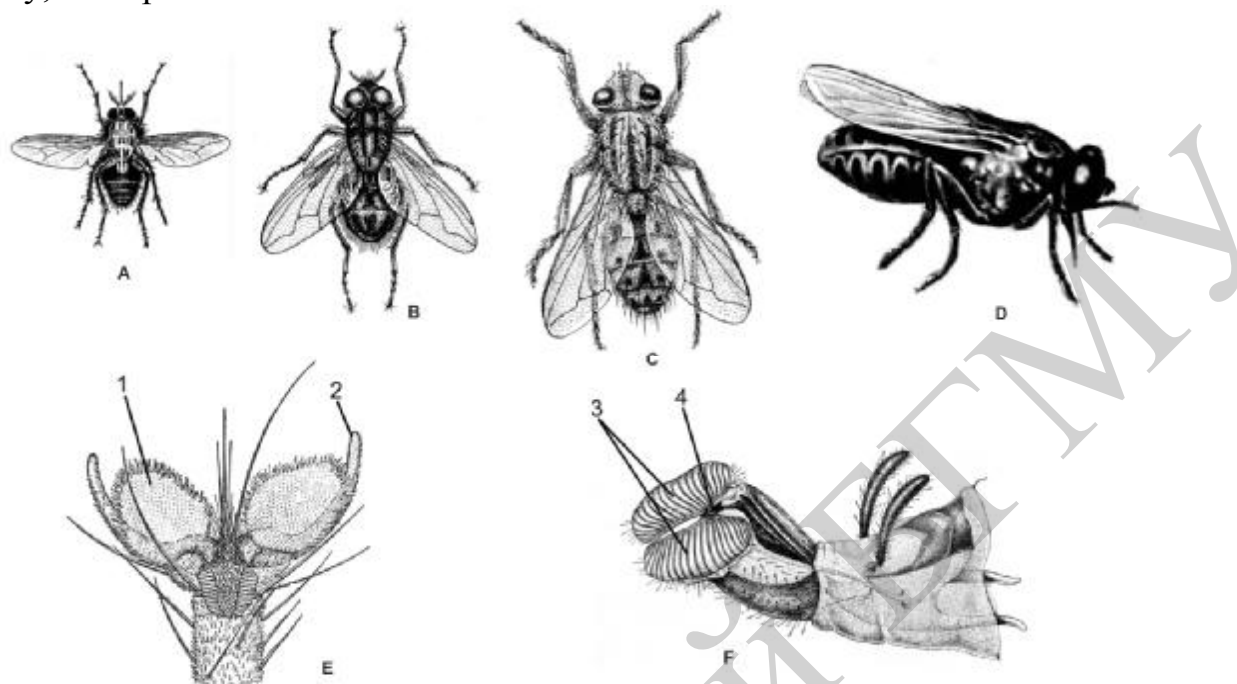

Fig. 58. Morphology of Mucidae family representatives:

A — *Stomoxys calcitrans*; B — *Musca domestica*; C — *Wohlfahrtia magnifica*; D — *Glossina palpalis*; E — a paw of the filth fly, F — oral organs of the filth fly: 1 — a cushion; 2 — a claw; 3 — a lower lip; 4 — an oral opening

Fighting against flies. To fight against winged flies, insecticides, sticking tapes, baits with poisons are used, they are also eliminated mechanically. In fighting against pre-imago stages, building of public facilities is of great importance: the presence of sewerage systems, closed garbage collectors, manure store houses, toilets, refuse removal, using insecticides.

Biting fly (*Stomoxys calcitrans*). It is 5–6 mm in size, coloration is grey with dark stripes on the breast and with spots on the abdomen. Using its proboscis the fly scrubs off the skin epidermis and feeds on blood (both males and females); the saliva contains poisonous substances causing a severe irritation. Bites are painful. The population of flies reaches its maximum in August–September. The female lives about 20 days. It is a mechanic pathogens transmitter of anthrax and sepsis. **Fighting measures:** the same as against the filth fly.

Tsetse fly (*Glossina palpalis*) is met in western areas of the African continent. It lives near human dwellings along banks of rivers and lakes with a high humidity of the soil. They have large sizes (up to 13 mm), the proboscis is strongly chitinized, protrudes forward. The coloration is dark-brown. Females are viviparous, lay only one larva on the soil surface. The larva permeates into the soil, pupates and in 3–4 weeks an imago form comes out. During the whole

life (3–6 months) females lay 6–12 larvae. It feeds on blood of animals and humans, is a reservoir and a specific pathogens transmitter of African trypanosomiasis. **Fighting measures:** cutting down bushes and trees along river and lake banks near settlements and along roads. Insecticides are used to fight against mature flies.

Wohlfahrt's fly (*Wohlfahrtia magnifica*) is common in countries with a moderate and hot climate. The body is of a light-grey color, its size is 9–13 mm and there are 3 dark longitudinal stripes on the breast. Mature flies feed on nectar of plants. Females lay 120–150 larvae in open cavities (the nose, eyes, ears) on the wounds and ulcers on animal bodies, sometimes — on humans (during sleep in the open air. Larvae live in ears, nose, frontal sinuses and eyes. Having implanted into tissues they destroy them to the bones. Parasitizing of larvae causes myiasis. The disease is accompanied by a severe pain, tissue necrosis. In 5–7 days larvae fall out into the soil and pupate. Prophylactic measures are directed towards prevention people from attacks of flies.

5. Medical significance of horse-flies.

Horse-flies (families: gastric horse-flies — *Gastrophilidae*, subcutaneous horse-flies — *Hypodermatidae* and cavital — *Oestridae*) are common everywhere. Mature horse-flies live several days and do not eat. They lay eggs or produce living larvae that cause myiasis.

Large gastric horse-fly (*Gastrophilus intestinalis*) lays eggs on the hair of horses (fig. 59). Larvae implant into the skin causing itching. Scratching itching sites with teeth horses swallow larvae. Larvae together with horse excrements get into the soil and pupate. Sometimes a female of the horse-fly lays eggs on the human hair. Larvae permeate into the skin (face, breast), where they make passages of 3–5 cm long and parasitize 1–2 months.

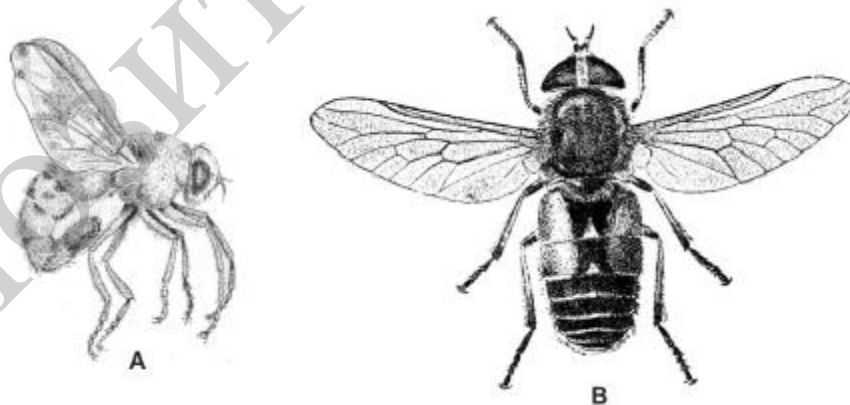

Fig. 59. Gadflies and horse-flies:

A — a horse-fly (*Gastrophilus intestinalis*); B — a gadfly (*Tabanus autumnalis*)

Ox gadfly (*Hypoderma bovis*) lays eggs on the hair of animals, sometimes on hairy parts of the human body, from where larvae migrate into tissues completing their development in the hypodermal adipose cellular tissue on the back, arms, face. Pupation occurs in soil.

Sheep gadfly (*Oestrus ovis*) and Russian gadfly (*Rhinoestrus purpureus*). Females are viviparous; they throw out a stream of fluid containing larvae in the air, into nostrils or eyes of animals or humans. The development of larvae occurs in nasal cavities, sinuses, in eye-balls, in the cranial cavity. They leave the host before pupation entering the environment through nostrils. Larvae of gadflies in the human are removed surgically.

6. Fighting measures with 2-winged insects.

Direct protection from attacks of insects (wearing of closed clothes, putting nets on windows), using insecticides and repellents; zooprophyllaxis — making biological barriers (cattle breeding farms) between hatching places of insects and dwelling houses; drainage of marshes, dissipation of chemical substances in wintering places of insects.

Basic terms and concepts:

1. Winged blood-sucking insects — a group of small 2-winged blood-sucking insects (midges, greases, gnats and mosquitoes).

2. Gonotrophic cycle — maturation of eggs in females of 2-winged insects in digestion of blood.

3. Zooprophyllaxis — making biological barriers between hatching places of gnats (houses for the cattle) and dwelling houses.

4. Myiasis — a disease caused by larvae of flies and horse-flies.

5. Repellents — chemical substances, which scare away insects.

EVOLUTION OF ORGAN SYSTEMS

CLASSES I

1. Biogenetic law, A. N. Severtsev's study about phylembryogeneses.

In 1866 E. Geckel formulated a biogenetic law: *ontogenesis is a short and fast recurrence of phylogenesis due to hereditary characters and adaptability*.

Ch. Darwin confirmed the association between onto- and phylogenesis and developed a study about **recapitulations** — recurrence of ancestors' characters in germs on phylogenesis in the process of ontogenesis.

Further embryological studies showed that this biogenetic law was valid only in general features: none of the germ's development stages repeated in full the structure of ancestors on phylogenesis; in ontogenesis the structure of embryos is repeated but not adult stages of ancestors.

The study of A. N. Severtsev about phylembryogenesis is very important for explanation of the relation between onto- and phylogenesis. **Phylembryogeneses** are embryonic reconstructions that are preserved in adult forms and have an adaptive significance. There are 3 types of phylembryogenesis:

1) **archalaxises** — are changes from the moment of an organ germination (the development of a hairy integument in mammals); for all that at the beginning of morphogenesis mutated genes become involved in the work and the development takes a new course (recapitulations are absent);

2) **deviations** — diverging from the middle of the organ development course (the development of scales in reptiles); initially the process goes according to phylogenesis (partial recapitulation), and in the middle of morphogenesis mutated genes interfere with the work and the course takes another direction;

3) **anabolia** — further development of the organ (from a 2-chamber heart to a 4-chamber heart); at first all preceding stages of the organ development recapitulate, and only at the end of embryogenesis mutated genes interfere and a new character is germinated.

In some development defects the human obtains characters characteristic of orders or classes of the Chordate type. They occur due to ontophylogenetic mechanisms: recapitulations, parallelisms. **Recapitulations** occur as a result of insufficiency or absence of anabolism. The examples of defects due to recapitulations: a 3-chamber heart, preservation of embryonic vessels, 2 aortal arches, retardation of kidneys development, doubling of ureters. **Parallelism** is an independent development of similar characters in the evolution of closely related groups of organisms (in the human and animals with similar origin). An example of parallelism in the human is polymastia.

2. Phylogenesis of body integuments in chordal animals.

Skin integuments develop from two germinal layers: an ectoderm (epidermis) and a mesoderm (derma).

Basic evolution directions:

1. Differentiation into 2 layers: an external layer — epidermis, an internal — derma and thickening of the derma.
2. From one-layer to multilayer epidermis.
3. Differentiation of the derma into 2 layers — papillary and net.
4. Appearance of subcutaneous adipose cellular tissue and improvement of thermoregulation mechanisms.
5. From unicellular glands to multicellular ones.
6. Development of various skin derivatives.

The Lancelet has a one-layer epidermis, it is cylindrical, has glandular cells excreting mucus. The derma is presented by a thin layer of incompletely formed connective tissue.

In lower vertebrates the epidermis is multilayer. Skin derivatives: unicellular (in fish) and multicellular (in amphibians) mucous glands; scales (in fish).

In amphibians the skin is thin, without scales, contains a great number of mucous glands, the secret of which moistens integuments and produces an anti-bacterial effect. The skin participates in gas exchange.

In reptiles corneous scales develop, and skin glands are absent.

In mammals: The epidermis and derma are well developed; there appears a subcutaneous adipose cellular tissue. A great number of glands are in the skin: sweat, sebaceous, lactiferous and odorous. There are also various derivatives of a corneous layer: hair, horns, claws and hoofs. There is a net and a papillary layer in the derma. The papillary layer contains nerve receptors, blood and lymph vessels.

3. Phylogenesis of the axial skeleton of the chordates.

Basic evolution directions:

1. Replacement of a chord for a spine, a cartilaginous tissue for a bony one.
2. Differentiation of the spine into departments (from 2 till 5).
3. Enlargement of the number of vertebrae in departments.
4. Formation of the chest.

Cartilaginous fish preserve a chord during all their life, but germs of vertebrae appear in them. In fish develop vertebral bodies, osteal and transverse processes and a spinal canal is formed. The spine consists of 2 departments: of the trunk and the tail. There are ribs in the trunk department that end freely in the abdominal side of the body.

In amphibians 2 new departments appear: cervical and sacral, each containing one vertebra. There is a cartilaginous breastbone. Ribs in caudates do not reach the breastbone, in non-caudates they are absent.

In reptiles the cervical department has 8–10 vertebrae, the thoracic and lumbar department — 22 vertebrae, the sacral — 2 and the caudal — some tens of vertebrae. The first two cervical vertebrae provide mobility of the head; the last 3 vertebrae have per 1 pair of ribs. The first 5 pairs of ribs of the lumbar-thoracic department are attached to a cartilaginous breastbone forming the chest.

In mammals the spine consists of 5 departments. The cervical department has 7 vertebrae, thoracic — from 9 to 24, lumbar — from 2 to 9, sacral — 4–10 and more, in the caudal department the number of vertebrae varies. There occurs reduction of ribs in the cervical and lumbar departments. The breastbone is bony. 10 pairs of ribs reach the breastbone forming the thorax.

4. Phylogenesis of the brain and visceral departments of the skull in chordates.

Basic evolution directions:

1. Joining a visceral (facial) department to a cranial one, enlargement of the cranial department volume.
2. Decrease in the number of bones at the expense of their fusion.
3. Replacement of a cartilaginous skull for a bony one.
4. Mobile joining of the skull with the spine.

The cranial department of the skull in vertebrates develops just as continuation of an axial skeleton, the visceral department being a support for the respiratory system and an anterior part of the digestive system. Germination of an axial

skull occurs from 2 basic departments: a chordal — **parachordaly** on the sides of the chord and perichordal — **trabecula** in front of the chord (fig. 60).

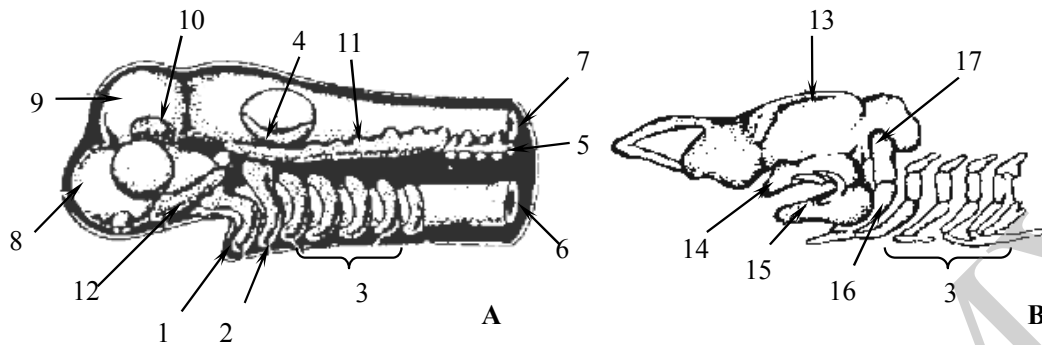

Fig. 60. A cartilaginous skeleton of the shark:

A — a germ, *B* — a mature species: 1 — a mandibular arch; 2 — a hyoid arch; 3 — III–IV branchial arches; 4 — a hearing capsule; 5 — a chord; 6 — an intestine; 7 — spinal cord; 8 — an anterior brain bladder; 9 — a middle brain bladder; 10 — orbital cartilages; 11 — parachordalies; 12 — trabeculae; 13 — a cranial skull; 14 — a palatal quadrate cartilage; 15 — a Meckel's cartilage; 16 — a hyoid; 17 — a hyomandibular cartilage

Trabeculae and parachordalies overgrow and fuse together forming the skull from beneath and the sides. Olfactory and hearing capsules adhere to it. Lateral sides are filled with orbital cartilages. The cranial skull undergoes 3 development stages: that of a connective tissue, cartilaginous and bony.

Fish. The cranial skull is cartilaginous. There appears an occipital department. A visceral skull consists of 5–6 cartilaginous arches that envelope an anterior department of the digestive tube. Arch I is mandibular, consists of an upper cartilage — a palatal quadrate that forms a primary upper jaw. A lower cartilage — Meckel's, forms a primary lower jaw. Arch II — hyoid, consists of 2 upper hyomandibular cartilages and 2 lower — hyoids. The hyomandibular cartilage adheres to the base of the cranial skull from each side; the hyoid connects with the Meckel's cartilage (a **hyostyle type**). The dome of the cranial skull is tightly connected with the spine.

The skull in **ground vertebrates** has a mobile connection with the spine.

Amphibians have functioning secondary jaws. The palatal-quadrate cartilage of the 1st maxilla arch adheres to the base of the cranial skull (an **autostyle type**). The hyomandibular cartilage of the hyoid arch loses its role of a maxilla arch pendant and transforms into a hearing bone (column). The Meckel's cartilage is reduced, the hyoid transforms into processes of the hyoid. The rest visceral arches (they are 6) are preserved as a hyoid and a cartilaginous pharynx.

In reptiles the skull ossifies, there are many covering bones. The connection of the visceral and cranial skull occurs at the expense of an ossified part of the reduced palatal-quadrate cartilage. The skull is **autostylish**. The jaws are secondary. The secondary hard palate and orbital arches are formed.

In mammals the dome of the skull is formed by frontal and bregma bones. The mandible consists of one bone and its process forms a joint connecting it with the cranial skull. The palatal-quadrate and Meckel's cartilages are transformed into an anvil and a hammer. The upper department of the hyoid arch forms a stirrup. Parts of branchial arches II and III form a shield-like pharyngeal cartilage, branchial arches IV and V are transformed into pharyngeal cartilages. **In higher mammals** the cranial skull volume is considerably increased. In the human the facial skull sizes are diminished as compared to the cranial department, the skull is rounded and smooth. An orbital arch is formed (**a synap-cidal type** of the skull).

5. Phylogenesis of the nervous system in chordates.

The nervous system has an ectodermal origin, is built as a nervous tube.

Basic evolution directions:

1. Differentiation of the nervous tube into the brain and the spinal cord.
2. Evolution of the brain :
 - a) from the stage of 3 brain bladders to 5 brain bladders and 5 brain departments;
 - b) appearance of the brain cortex and enlargement of its surface at the expense of furrows and convolutions;
 - c) from an ichthyopsidic to a sauropsidic and a mammal type of the brain.
3. Differentiation of the peripheral nervous system.

In the Lancelet CNS is presented by a nervous tube. Its anterior part is dilated, an olfactory pit is located on it. Light-sensitive cells are located through the whole length of the tube (Gesse's eyes).

On the front end of the nervous tube 3 brain bladders are germinated (anterior, middle and posterior). Then the anterior and posterior bladders are divided and 5 bladders form, from which the brain departments develop: frontal (**telen-cephalon**), intermediate (**diencephalon**), middle (**mesencephalon**), the cerebellum (**metencephalon**) and elongated (**myelocephalon**). There are cavities inside the departments (cerebral ventricles) that continue and pass into the spinal cord. The part of the brain located over the ventricles is called the **dome** (mantle), and below it — the **bottom** of the brain.

In fish the brain is small. The front brain is not divided into hemispheres. The dome is epithelial; the bottom of the brain is presented by striated bodies. Olfactory lobes are small. The intermediate brain is presented by the thymus and hypothalamus. The middle brain is large; it is an integrating center (an **ichthyo-cidic** type of the brain). In the area of the middle brain a convolution appears. The cerebellum is well developed. There are 10 pairs of intracranial nerves (fig. 61).

In amphibians: 1) the volume of the front brain increases; 2) the front brain is divided into 2 hemispheres; 3) a nervous tissue appears in the brain dome; 4) striated bodies are well developed. Olfactory lobes are separated from

the hemispheres. The intermediate brain is presented by the thalamus and hypothalamus. The middle brain is large and is an integrating center. The cerebellum is poorly developed. The elongated brain is developed as in fish. There are 10 pairs of intracranial nerves.

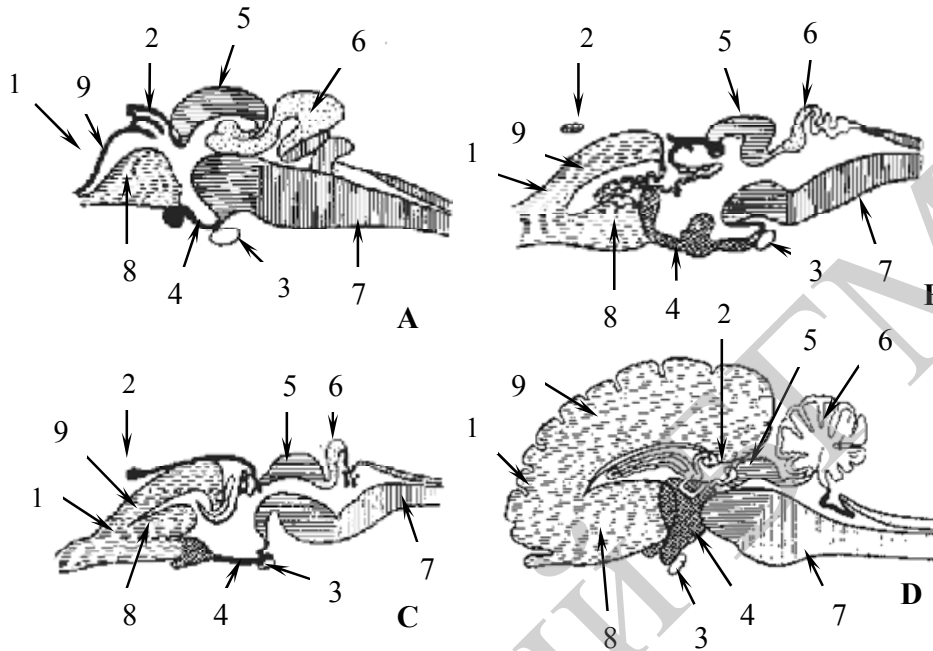

Fig. 61. The brain of vertebrates (a longitudinal section):

A — a bony fish, *B* — an amphibian, *C* — a reptile, *D* — a mammal: 1 — a front brain; 2 — an epyphysis; 3 — a hypophysis; 4 — an intermediate brain; 5 — a middle brain; 6 — a cerebellum; 7 — an elongated brain; 8 — striated bodies of the front brain; 9 — a mantle (dome)

In reptiles the front brain becomes the largest department. Large olfactory lobes are differentiated, sincipital lobes are separated. Hemispheres of the brain have cortex germs on lateral surfaces. The cortex has a primitive structure (3 layers of cells) — **archipallium**. The front brain (striated bodies) is an integrating center: such type of the brain is called **sauropsidic (striatal)**. The sizes of the middle brain are diminished (it loses the function of an integrating brain). The cerebellum is considerably enlarged. The elongated brain forms a sharp convolution in the vertical plane. There are 12 pairs of intracranial nerves.

In mammals the front brain reaches the most development at the expense of the secondary cortex (**neopallium**). In lower mammals the cortex surface is smooth, and in higher mammals furrows and convolutions form. The secondary cortex is an integrating center (a **mammal** type). The intermediate brain is covered by the front brain. The middle brain is diminished, forms a quadrihillock (2 upper prominences are subcortical centers of vision, 2 lower ones — subcortical centers of hearing). The cerebellum is considerably enlarged in sizes, is differentiated into two hemispheres and a middle part — a worm. There are 12 pairs of intracranial nerves, 3 convolutions of the brain: 1) sincipital — at the level of the middle brain, 2) occipital — in the area, where the elongated

brain passes into the spinal cord, 3) pontine — in the area of the posterior part of the brain.

6. Phylogenesis of the digestive system of chordates.

The digestive system develops from the endoderm, its initial and final departments — from the ectoderm.

Basic evolution directions:

1. Differentiation of the digestive tube into departments.
2. Development of digestive glands.
3. Appearance of teeth and their differentiation.
4. Enlargement of the absorption surface at the expense of the intestines elongation and appearance of cilia.

In the Lancelet the digestive system is presented by a straight tube that is differentiated into a pharynx and intestines. The pharynx is pierced with branchial slits. The digestive tube forms a hepatic growth.

In fish jaws and homogenous teeth appear (a homodontal dental system), an esophagus, stomach, small and large intestine. The liver is well developed; there is a gall-bladder. The pancreas is slightly separated.

Amphibians have an oral-pharyngeal cavity, homogenous teeth, esophagus, small and large intestine, liver, pancreas. There appeared a muscular tongue and salivary glands. There are no enzymes in the saliva. There appear a duodenum and rectum. The intestines end with a cloaca.

In reptiles the oral cavity is separated from the pharynx, differentiation of teeth starts (venomous teeth), stomach walls are thick, there is a caecum germ, the intestine elongates and ends with a cloaca.

Mammals have a heterodontal dental system (incisors, canines and molars). Fleshy lips appear. The saliva contains enzymes. The intestine is differentiated into a small and large intestine, the caecum is well developed, it has an appendix. The rectum is terminated with an anal opening. The mucous membrane of the intestines has a great number of folds, in a small intestine — cilia.

7. Ontophylogenetic etiology of the development defects of integuments, skeleton, nervous and digestive systems in the human.

Ontophylogenetic reasons of skin defects (etiology — recapitulations): absence of sweat glands, ichthyosis, redundant hairiness of the face and the body, polymastia.

Ontophylogenetic reasons of defects of the brain (etiology — recapitulations): absence of differentiation of hemispheres, incomplete separation of hemispheres of the front brain (prosencephalia), an ichthiopsidic, sauropsidic types of the brain.

Ontophylogenetic reasons of skeleton defects: additional ribs at the 7th cervical or at the 1st lumbar vertebra, splitting of dorsal vertebral arches, non-atresia of osteal vertebral processes (Spina bifida), increase of the number of sacral vertebrae, the presence of a tail.

Ontogenetic reasons of skull defects: increasing of bony elements, non-atresia of the hard palate «a cleft palate», frontal suture; one hearing bone; absence of the chin prominence.

Ontophylogenetic reasons of the digestive system defects: fistulas of the neck (rupture of branchial pockets), homodontal dental system, additional lobes of the liver and pancreas, shortening of the intestines.

Basic terms and concepts:

1. **Anabolia** — additions to the organ development. They arise after the organ has completed its development.

2. **Archallaxis** — changes since the time of the organ germination; the development goes by another way.

3. **Deviation** — deflection from the middle of the organ development. At early stages — a partial recapitulation.

4. **Sauropsidic type of the brain** — an integrating center — striated bodies of the frontal brain.

5. **Ichthiopsidic type of the brain** — an integrating center — the middle brain.

6. **Mammal type of the brain** — an integrating center — a new cortex of the brain.

7. **Parallelism** — an independent development of similar characters in evolution of closely related groups of organisms.

8. **Recapitulation** — recurrence of ancestral characters in germs on phylogenesis in the process of ontogenesis.

9. **Phylembryogenesis** — embryonic reconstructions that are preserved in mature forms and have an adaptive significance.

CLASSES II

1. Phylogenesis of the respiratory system of Chordates.

The respiratory system has an entodermal origin.

Basic evolution directions of the respiratory system:

1. From branchial slits of the Lancelet to the branchial apparatus of the fish.

2. Enlargement of the respiratory surface at the expense of branchial lobes formation; formation of branchial capillaries.

3. From the branchial apparatus to organs of ground respiration — lungs.

4. Development and differentiation of respiratory ways, formation of a bronchial tree.

5. Enlargement of the respiratory surface of the lungs, formation of the chest and appearance of the diaphragm.

In the Lancelet: 100–150 pairs of interbranchial septa piercing the pharynx, in the vessels of which gas exchange takes place. These are carrying to and carrying out branchial arteries. There are no branchial capillaries.

In fish in the anterior part of the pharynx branchia develop. In the capillaries of branchial lobes gas exchange takes place. In the **crossopterygian** fish appear organs of air breathing — a germ of a lung of ground vertebrates a paired growth of the pharyngeal wall with an abdominal side.

Caudalless amphibians have a common pharyngeal-tracheal chamber, in the caudates it is separated into a pharynx and a trachea (fig. 62).

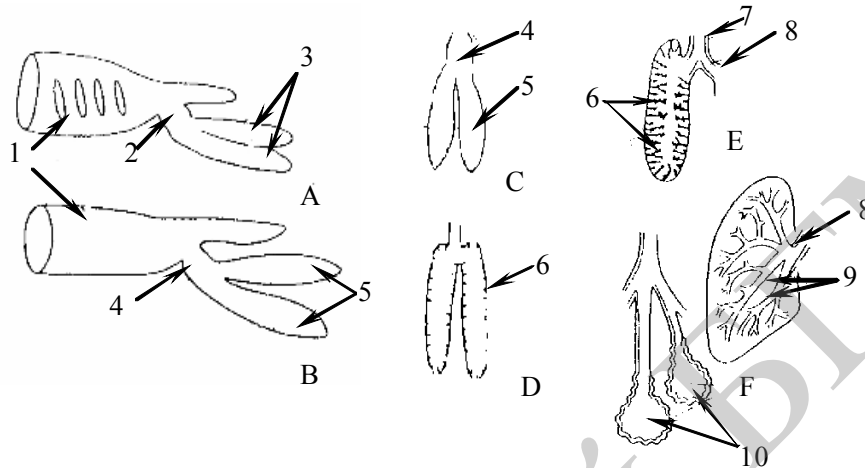

Fig. 62. Evolution of the lungs in vertebrates:

A — a pharynx and a swimming bladder (lungs) of the crossopterygian fish, *B* — a pharynx and lungs of the amphibians, *C* — a caudal amphibian, *D* — a caudalless amphibian, *E* — a reptile, *F* — a mammal: 1 — a pharynx; 2 — an unpaired chamber connecting the swimming bladder with the pharynx; 3 — sacs of the swimming bladder; 4 — a pharyngeal-tracheal chamber; 5 — lung sacs; 6 — intralung septa; 7 — a trachea; 8 — a bronchus; 9 — bronchial branches; 10 — alveoli

There appear Seiler's cartilages and voice cords in the pharynx. Caudalless amphibians have septa in the lungs. The lungs of **caudal amphibians** are presented by two thin-walled sacs without any septa. Ventilation of the lungs is weak, that's why the skin participates in respiration.

In reptiles the respiratory surface of the lungs is increased by cellular bars, where blood vessels pass. There appear out-of-lungs bronchi, in the pharynx — an innominate cartilage. Cartilaginous rings are formed in the trachea. The chest is formed: the connection of the ribs and the spine and breast is mobile, intercostal muscles develop.

In mammals a nasal cavity, a nasopharynx are formed, in the pharynx — a shield-like cartilage. A bronchial tree develops. Bronchioles and alveoli considerably increase the respiratory surface (the number of alveoli is up to 500 million). The chest separated by the diaphragm from the abdominal cavity takes part in respiration.

2. Phylogenesis of the blood circulatory system of chordates.

The blood circulatory system has a mesodermal origin.

Basic evolution directions:

1. Germination and differentiation of the heart (from a 2-chamber to a 4-chamber heart).
2. Development of the 2nd (pulmonary) blood circulation and a final separation of the venous and arterial blood.
3. Transformation of branchial arteries (arterial arches) and differentiation of vessels branching off the heart.

The Lancelet has one circulation. Through the abdominal aorta the venous blood comes into carrying-in branchial arteries, the number of which corresponds to the number of interbranchial septa (up to 150 pairs), where it gets enriched with oxygen. Through carrying-out branchial arteries the blood comes to carotid arteries (they carry blood to the anterior department of the body) and into a dorsal artery, which branches into multiple arteries, and carries the blood throughout the organism (fig. 63).

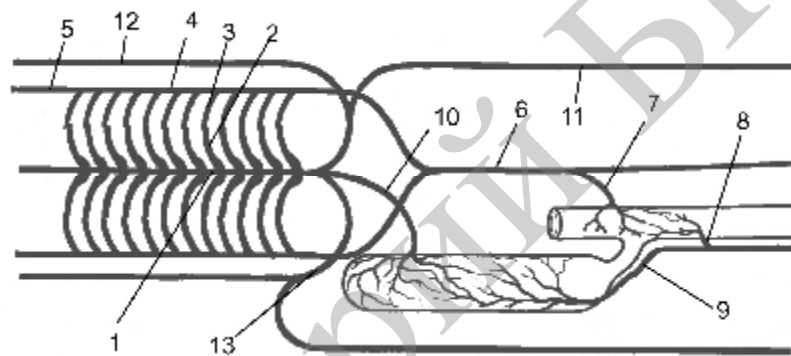

Fig. 63. The circulatory system of the Lancelet:

1 — an abdominal aorta; 2 — carrying-in branchial arteries; 3 — carrying-out branchial arteries; 4 — roots of a dorsal artery; 5 — carotid arteries; 6 — a dorsal artery; 7 — an intestinal artery; 8 — a subintestinal vein; 9 — a portal vein of the liver; 10 — a hepatic vein; 11 — a right posterior vein; 12 — a right anterior cardinal vein; 13 — a left Cuvier's vessel

After gas exchange the venous blood accumulates in paired anterior and posterior cardinal veins located symmetrically. The anterior and posterior cardinal veins from each side fuse into Cuvier's ducts. They empty into the abdominal aorta. In the area of a hepatic protuberance a portal system is formed, the blood from which passes into an abdominal aorta through a hepatic vein.

Fish have one circulation. The heart is located beneath the mandible and consists of two chambers (an atrium and a ventricle) and contains venous blood. A venous sinus adjoins the atrium, an arterial cone comes off the ventricle, which passes into the abdominal aorta. During embryogenesis 5–7 pairs of branchial arteries are germinated, then the 1st, 2nd and 7th are reduced, and the 3rd–6th pairs stop functioning.

In amphibians the 2nd circulation develops due to the appearance of the lungs. The heart consists of two atria and one ventricle. A venous sinus adjoins the right atrium, an arterial cone comes off the ventricle (fig. 64).

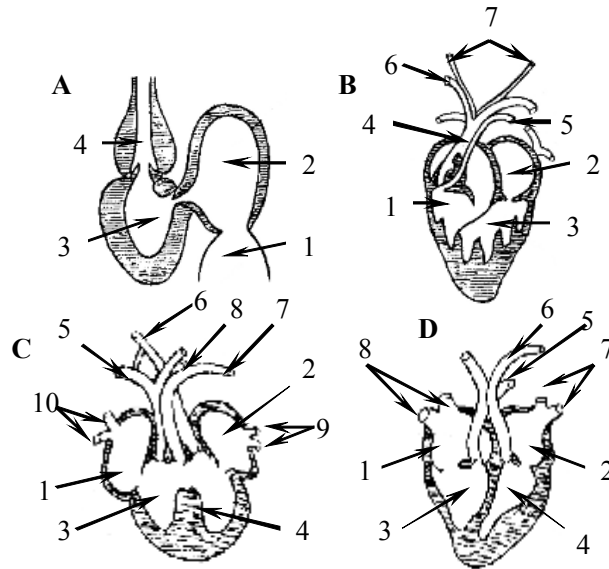

Fig. 64. Heart evolution of vertebrates:

A — fish: 1 — a venous sinus; 2 — an atrium; 3 — a ventricle; 4 — an aortal bulb; *B* — amphibian: 1 — a right atrium; 2 — a left atrium; 3 — a ventricle; 4 — an arterial cone; 5 — a left cutaneous-pulmonary artery; 6 — a right arch of the aorta; 7 — carotid arteries; *C* — reptiles: 1 — a right atrium; 2 — a left atrium; 3 — a ventricle; 4 — an interventricular septum; 5 — a right pulmonary artery; 6 — a right arch of the aorta; 7 — a left arch of the aorta; 8 — a left duct of Botallo; 9 — pulmonary veins; 10 — vena cava; *D* — a mammal: 1 — a right atrium; 2 — a left atrium; 3 — a right ventricle; 4 — a left ventricle; 5 — a left pulmonary artery; 6 — a left arch of the aorta; 7 — pulmonary veins; 8 — vena cava

The atria open into a common orifice: venous blood comes from the right atrium and arterial — from the left one. The blood in the right part of the ventricle is venous, it is mixed in the center and arterial in the left part. The blood is distributed into 3 pairs of vessels through the arterial cone: venous blood goes to the skin and lungs through the cutaneous-pulmonary arteries; mixed blood goes to all organs and tissues through aortal arches and arterial blood — to the brain through carotid arteries. 6–7 pairs of branchial arteries are geminated during embryogenesis: the 1st, 2nd, 5th and 7th are reduced, from the 3rd one carotid arteries develop, from the 4th one — arches of the aorta, from the 6th — cutaneous-pulmonary arteries (fig. 65).

In reptiles the heart consists of 3 chambers, an incomplete septum appears in the ventricle. The pulmonary artery springs off the right part of the ventricle, it carries venous blood to the lungs; from the left part — the right arch of the aorta that carries arterial blood to the brain and front limbs. The left arch of the aorta springs off the center of the ventricle, it carries mixed blood. Behind the heart 2 arches of the aorta fuse into one vessel and carry mixed blood to all organs. 6 pairs of branchial arteries are germinated. They transform into the same vessels as in amphibians (the 5th pair — into pulmonary arteries).

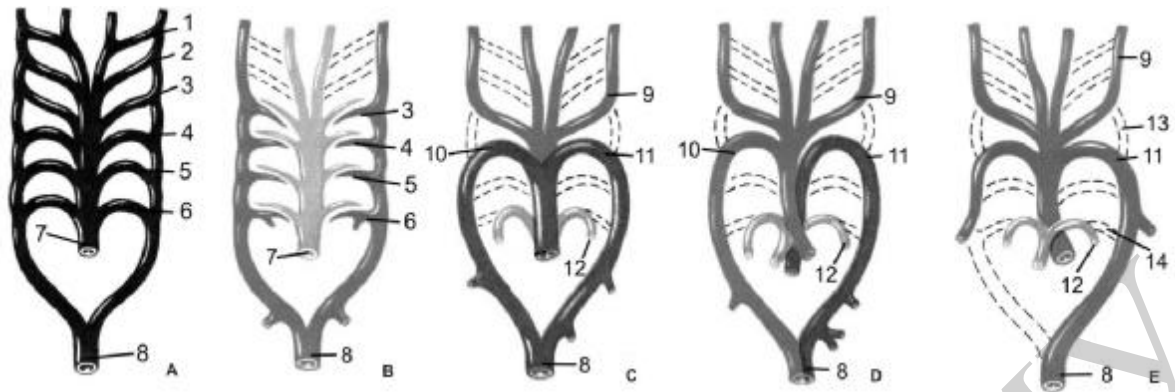

Fig. 65. Development of arterial arches in vertebrate animals:

A — a germ of a vertebrate, *B* — a fish, *C* — a caudalless amphibian, *D* — a reptile, *E* — a mammal: 1–6 — arterial (branchial arches); 7 — an abdominal aorta; 8 — a dorsal aorta; 9 — carotid arteries; 10 — a right arch of the aorta; 11 — a left arch of the aorta; 12 — pulmonary arteries; 13 — a carotid on-flow; 14 — a duct of Botallo

In mammals there is observed a complete division of the heart into the left and right halves, a complete separation of the blood into arterial and venous. The right heart part contains venous blood, while the left one — arterial blood. The pulmonary circulation starts from the right ventricle with pulmonary arteries and terminates in the left atrium with pulmonary veins. The general circulation starts from the left ventricle with a left arch of the aorta and ends in the right atrium with vena cava.

6 pairs of branchial arteries are geminated in embryogenesis, then in the process of development the 1st and 2nd pairs are reduced; the 3rd pair gives carotid arteries; the 4th right pair is reduced, the left one forms an arch of the aorta; the 5th pair is reduced; the 6th — forms pulmonary arteries.

3. Phylogenesis of the excretory system of chordates.

The excretory system has a mesodermal origin, it is built according to a nephridia type in the Lancelet, in vertebrates it is represented by kidneys.

Basic development directions:

1. From nephridia of the Lancelet to a compact organ — a kidney in vertebrates.

2. From a head kidney to a body and pelvic kidney at the expense of increasing the number of nephrons and coming together of the nephrons and blood capillaries, elongation of nephron canaliculi.

The Lancelet has 100–150 pairs of nephridia — short tubules that open with one end into a celom, and with the other — into a peribranchial cavity. A glomerule of capillaries is in the celom wall near canaliculi.

In phylogenesis of vertebrates 3 generations of kidneys change successively each other: a head kidney — **pronephros**, a primary (body) kidney — **mesonephros**, a secondary (pelvic) kidney — **metanephros**.

A nephron is a basic structural-functional unit.

The pronephros of fish and amphibian larvae has 6–12 nephrons. The nephron consists of a funnel (a nephrostoma) and a short canaliculus. Nephrostomas open into a celom, and canaliculi — into a ureter of the kidney. In the celom wall near nephrostomas a capillary glomerule is located (fig. 66).

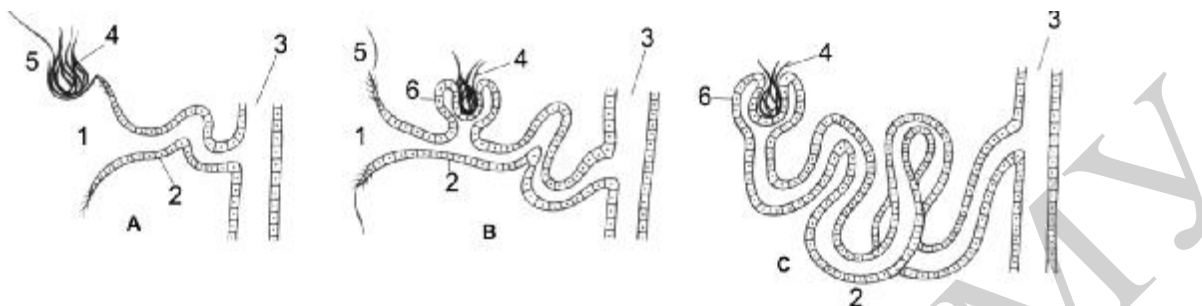

Fig. 66. Evolution of the nephron:

A — a pronephros, *B* — a mesonephros, *C* — a metanephros: *1* — a nephrostoma; *2* — a nephron canaliculus; *3* — a ureter; *4* — a glomerule; *5* — a celom; *6* — a nephron capsule

Dissimilation products pass from the blood into a celom, then through a nephrostoma into a canaliculus, and then into a ureter of the pronephros (pronephric canal). The ureter opens into the cloaca.

The mesonephros (mature fish and amphibians) contain approximately 100 nephrons. Around some capillary glomerule forms a wall growth of a canaliculus as a 2-walled capsule. Nephrostomas are preserved. Dissimilation products are removed from the blood in two ways. The 1st way — from a nephrostoma into a canaliculus, the 2nd — from a capillary glomerule into a canaliculus. In the process of development the perinephric canal is split longitudinally into 2 canals — Muller's and Wolf's. In the course of development the Muller's canal becomes atrophied in males of lower vertebrates, and in females it is transformed into an egg-duct. The Wolf's canal transforms into a ureter in females, in males it functions as a ureter and a semen-duct.

In amniots (higher vertebrates) a metanephros functions, it contains about 1 million nephrons. There is no nephrostoma, the canaliculus wall completely envelopes a capillary glomerule (forming a renal body: a capsule of Shumlyansky-Bowman and a capillary glomerule), then the canaliculus is differentiated into a descending part, the Henle's loop and an ascending part. Removal of dissimilation products from the blood occurs directly into a canaliculus. In vascular glomerule, filtration of blood plasma occurs, and in canaliculi — reverse absorption of water, amino acids and glucose from primary urine. The dilation of the posterior part of the ureter forms a urine bladder.

4. Ontophylogenetic reasons of development defects of the respiratory, cardio-vascular and urogenital systems in the human.

Ontophylogenetic etiology of the respiratory system in the human: underdevelopment of the pharynx or the lungs, cystic hypoplasia, abnormal branching of bronchi, hypoplasia of the diaphragm, etc.

Ontophylogenetic etiology of development defects of the cardiovascular system: a defect of the interventricular septum, non-atresia of a Botallo's duct, an abnormality of the aortic-pulmonary septum (incomplete separation of the arterial trunk into an aorta and a pulmonary trunk), transposition of vessels, preservation of 2 aortal arches, etc.

Ontophylogenetic etiology of development defects of the urogenital system: a pelvic position of kidneys, preservation of a mesonephros, doubling of the ureter, a bicornuate uterus, a duplex uterus and vagina (on the type of parallelism).

Basic terms and concepts:

1. **Arterial arches** — branchial arteries.
2. **Arterial cone** — a muscular tube, the walls of which are capable of pulsation; it starts from the ventricle and is divided into a cutaneous-pulmonary and carotid arteries and aortal arches.
3. **Botallo's duct** — connects the aorta with pulmonary arteries and results in the outflow of arterial blood from the general circulation to the pulmonary circulation.
4. **Venous sinus** — a site, where vena cavea open in to the heart.
5. **Secondary kidney (metanephros)** — a pelvic kidney.
6. **Capsule of Shumlyansky-Bowman** — a double-layer cup surrounding a capillary glomerule.
7. **Mesonephric canal** — a ureter of the primary kidney.
8. **Nephrostoma** — a nephron funnel that opens into a celom.
9. **Primary kidney (mesonephron)** — a trunk kidney.
10. **A front kidney (pronephros)** — consists of 6–12 nephrons that have a funnel and a short canaliculi.
11. **Transposition of vessels** — changing the position of vessels.

VENOMOUS ANIMALS

1. Classification of venomous animals (primarily-secondarily venomous, actively and passively venomous).

Animals are venomous, if their organism produces substances or accumulates metabolites, which, having got into the other organism, can cause impairment of its functions or death. There are about 5 000 species of venomous animals: protists — 21, coelenterate — 93, parasitic worms — 16, ring worms — 50, arthropoda — about 4000, mollusks — 91, echinodermata — 26, fish — 500, amphibians — 40, reptiles — 250, mammals — 1 species. In accordance with the presence or absence of special venomous glands in animals, a specific apparatus for injecting venom into the victim and some other features, they are divided into the following groups: primarily-venomous and secondarily-venomous.

To primarily-venomous are referred animals, special glands of which produce a venomous secretion or if they have specific venomous metabolites. As a rule, venomness of these animals is a species character (jellyfish, scorpions, snakes, fish).

Secondarily-venomous animals accumulate exogenic poisons from the environment, they become toxic in case they are eaten by other organisms (fish adsorb industrial toxins from water).

Primarily-venomous animals are divided according to the ways of producing and using venoms. Actively-venomous armed animals have a specific venomous apparatus and a wounding mechanism (striking cells on tentacles of jellyfish, a sting in hymenoptera and venomous teeth in snakes). Venom is injected into the body of the victim parenterally (avoiding the digestive tract). Actively-venomous unarmed animals have no wounding apparatus. Secretions of their glands are toxic in direct contact with integuments of the victim (skin glands of amphibians, anal glands of insects).

Passively-venomous animals (fish, caudal amphibians, mollusks) can have toxic metabolites that are accumulated in various organs and tissues. They are dangerous only in case of getting into the digestive tract of the victim.

2. Physiological characteristic of toxins of invertebrates (jellyfish, arachnida, hymenoptera), their action on the human; the first aid and prophylactic measures against bites and poisoning.

Characteristic of animal venoms. Animal venoms or zootoxins — are biologically active substances that actively interact with biological structures. By their chemical structure, zootoxins are very diverse (alkaloids, histamine, various enzymes and their inhibitors).

By the character of physiological impact on living systems, zootoxins are subdivided into: 1) neurotoxins acting predominantly on the nervous system; 2) cytotoxins causing damage of cells and tissues; 3) hemorrhagens impairing permeability of blood vessels and 4) hemolyzins destroying erythrocytes.

A clinical picture of poisoning the human depends on: the venom composition, the site of affection, the season of the year and the time of the day as well as a general condition of the person.

Coelenterate phylum («cross» jellyfish and Portuguese man-of-war) refers to actively-venomous, armed. Striking cells excrete a neurotropic poison. It blocks synapses.

Clinics. In sites of a «burn» by tentacles of the «cross» jellyfish appears a sharp pain, reddening, rash. General manifestations: elevation of temperature, dropping of a muscular tone, pains in extremities and lumber area; impairment of consciousness, hallucinations, delirium, impairment of respiration and cardiac activity, in severe cases — death.

The first aid and prophylaxis of poisoning. One should remove parts of tentacles and striking threads from the skin surface, then paint the sites of affection

with alcohol or soda solution. Not to bathe in the thicket of water plants and in places of jellyfish gatherings.

Phylum of Arthropoda, class of Arachnoidea, order of Scorpions (yellow, Italian, black). They are actively-venomous armed, have venomous glands located on the last segment of the abdomen. Excrete a neurotropic poison that blocks neuron-muscular synapses.

Clinics. At the site of a bite appears a severe pain, edema, reddening, blisters. General manifestations: headache, weakness, impairment of consciousness, breathing difficulty, tachycardia in children. Fatal outcomes are possible.

The first aid and prophylaxis of poisoning. Sucking off the venom, applying cold on the site of a bite, taking pain-killers. Injection of a specific serum. Protection from bites: examination of dwellings, bedding, clothes, shoes.

Order of Arachnoidea. Actively-venomous armed, having venomous glands, their ducts open on chelicerae.

Karakurts. The neurotropic venom: it blocks neuron-muscular synapses.

Clinics. At a bite site appears pain, numbness of extremities. General manifestations: pain quickly spreads throughout the body, headaches, breathlessness, heartbeat, bronchial spasms, vomiting and impairment of consciousness. Fatal outcomes are possible.

The first aid and prophylaxis of bites. Sucking off the venom, cauteration of the bite site, injection of an antikarakurt serum. Prevention from getting carakurts to the places of human lodging for the night.

Tarantulas. The venom contains cytotoxins and hemorrhagens, causes the impairment of wall permeability.

Clinics. At a bite site — pain, reddening, edema, skin necrosis. General manifestations: malaise, sleepiness, chills, pulse acceleration, perspiration.

The first aid and prophylaxis of bites. To paint the site with some disinfectants, provide rest, abundant drinking, pain-killers. Protection from bites.

Class of Insects, order of Hymenoptera (bees, wasps). Actively-venomous armed, have venomous glands, a sting at the end of the abdomen. The venom has a neurotropic and cytotoxic action. A strong allergen.

Clinics. After a bite — pain, edema, reddening. General manifestations: allergic reactions.

3. Physiological characteristic of toxins of vertebrate animals (fish, amphibians, reptiles), their impact on the human; the first aid and prophylactic measures against bites and poisoning.

Fishes poisonous for the human are divided into 2 groups:

1. Species having venomous glands, the secretion of which is introduced into the wound done by fin rays, teeth or thorns of branchial covers. Representatives: skates, sea dragons, ruffs and perches, murenas. They are spread predominantly in tropic latitudes of the Pacific and Atlantic Ocean.

Pathogenic action and clinics. Toxins pass into the organism through a wound on the skin. At the moment of a prick one feels pain that quickly spreads to the whole extremity. There appears a feeling of fear, breathlessness, heart pain, vomiting, sometimes — loss of consciousness. Inflammation, sometimes ulcers and tissue necrosis develop at a bite site. A severe poisoning ends with death within a day.

Treatment: sucking off the venom from the wound, applying a tourniquet, symptomatic treatment. As prophylaxis one should put on special clothes in dealing with fish.

2. Fishes of the 2nd group cause poisoning, when it is used as food (murena, tuna, mackerel, perch-like, ball-fish). When these fishes are used as food, poisoning develops in 20–30 min. There appears numbness of the tongue and fingers, nausea, vomiting, breathlessness, speaking and breathing difficulty. The treatment is symptomatic. As prophylaxis, one should exclude the aforementioned fishes from the diet.

Amphibians. There are some toxic substances in the skin of some amphibians. The most virulent venom is produced by African tree frogs and toads. The venom of the Columbian frog cocoa (the length of 2–3 cm, the weight — a bit more than 1 g) acts 50 times stronger than a tetanus toxin. Other venomous amphibians are not dangerous for the human (they have no mechanism for injecting the venom into tissues). When it gets on the skin and mucous membranes, reddening and inflammation are observed. These symptoms are relieved by washing with water. One should take care lest amphibians' venom gets into the eyes.

Class of Reptiles. Families of asps and sea snakes (a royal and Indian cobra, a glandulous snake). These are primarily-venomous armed animals. On the anterior part of the maxilla they have venomous mobile teeth with canals for the venom to flow down from venom glands.

Pathogenic action and clinics. The venom contains neurotoxins, cytotoxins, hemolyzins. At a bite site develops pain, edemas, inflammation. General manifestations: excitation is replaced by depression of CNS; swallowing, speech and breathing are impaired. Fatal outcomes are possible.

Family of Vipers (gurza, sand efa, steppe viper, copperhead, rattle snakes). They are primarily-venomous, armed animals. They have venomous glands and venomous teeth with canals.

Pathogenic action and clinics. The venom contains neurotoxins, cytotoxins, hemolyzins, they increase blood coagulation. At a bite site develops pain, edemas, tissue necrosis. General manifestations: weakness, nausea, dizziness, impairment of blood coagulation. Fatal outcomes are possible.

The first aid and prophylaxis. The bite site should be painted with an anti-septic and a tight dressing should be applied. The patient should be transported

in a lying position. Injection of snakes' antitoxins should be done. In places of snakes' inhabitation one should not touch them but wear high boots.

Basic terms and concepts:

1. Actively-venomous animals — have a special venomous apparatus and a wounding mechanism (striking cells or tentacles of jellyfish, a sting in hymenoptera, venomous teeth in snakes).

2. Secondarily-venomous animals — accumulate exogenic poisons and become toxic when other organisms eat them.

3. Passively-venomous animals — their metabolites accumulated in various organs and tissues may become toxic.

4. Primarily-venomous animals — are animals, special glands of which produce a venomous secretion or some of their metabolites are toxic.

OPEN TESTS

HUMAN IN THE SYSTEM OF NATURE

1. The ability for changing the parameters of vital activity according to the change of environmental conditions is called
2. Interactions of populations of various species reflect ... the level of vital organisation.
3. The quadratic weight parameter of the human brain is
4. Homo sapiens reasonable belongs to the family
5. Homo sapiens reasonable belongs to the subclass

BIOLOGY OF THE CELL. THE FLOW OF SUBSTANCE AND ENERGY IN THE CELL

6. The ability of biological membranes to divide cytoplasm into compartments is called
7. The receptor apparatus located on the outside surface of a plasmalemma is called
8. Microfilaments of cytoskeleton have the diameter of ... nanometers.
9. EPR (endoplasmic reticulum) and ... form the transport system of the cell.
10. Conversion of fats into carbohydrates in a plant cell occurs in
11. Glyoxysomes are formed in
12. The destruction of natural frames of a cell by lisosomes is called
13. Integrated proteins in the structure of the outer mitochondrion's membrane, forming pores and providing permeability of membranes, are called
14. The larger subunit of ribosomes contains 40–50 molecules of proteins and ... molecules of r-RNA (ribosomal ribonucleic acid).
15. The efficiency of the anoxic stage of energy metabolism comprises ... %.

TEMPORAL ORGANIZATION OF THE CELL

16. The nuclear plate is basically formed by proteins ...
17. On the site of primary metafasal chromosomal strangulation is ... which attached strands of segmentation spindle.
18. The part of the DNA molecule in the site of the secondary satellite chromosomal strangulation is called
19. The content of genetical material during the G₂ interphase period is
20. The content of genetical material in a cell at the diploten stage pro-phases of meiosis I
21. The content of genetic material in a cell at the diakinesis stage of the prophase of meiosis I is
22. The content of genetic material in a cell at the pachiten stage of meiosis I

23. The bivalents are interconnected at the diploten stage of the prophase of meiosis I only in the parts called
24. ... are found in the equatorial plane of the metaphase of meiosis I.
25. The content of genetic material in a cell in the metaphase of meiosis II is

BASES OF CYTOGENETICS

26. Classification of chromosomes based on the methods of their differential staining is called
27. Classification of chromosomes due to the size of chromosomes, their form and the position of centromere is called
28. The difference of one pair of chromosomes from another by the size, gene pattern, location of centromere is the rule of
29. Chromosomes of the average size with the centromere index of 27–35 belong to the group of ... according to Denver classification.
30. The Y-chromosome belongs to the group of ... according to Denver classification of human chromosomes.
31. ... pairs of chromosomes are chromosomes of group D (according to Denver classification).
32. Chromosomes with secondary strangulation are called
33. X-chromosome belongs to the group of ... according to Denver classification.
34. Make a record of gene localization if it is in the front of the third part of the long arm of chromosome 1.
35. Make a record of gene localization if it is in the front of the fourth part of the short arm of chromosome 6.

ORGANIZATION OF HEREDITARY MATERIAL

36. The ability of one bacteria culture to build within its DNA parts of another culture's DNA and thus to acquire its properties is called
37. The property of bacteriophages to transfer the genetic information from one bacteria to another is called
38. ... carried out experiments on tobacco mosaic virus which proved the role of nucleic acids in the inherited information transfer.
39. The autosyntetical function of the DNA molecule is its
40. The DNA-polymerase can move along the matrix chain from the ... end to the ... end.
41. The direction of the genetic information reading from the 5' to the 3'-end is the property of the genetic code called
42. The tRNA identification process of its amino acid is

43. There is the mRNA triplet ... during the translation initiation in the peptidyle center of a ribosome.

44. The process which begins with the first peptide bond formation and ends up with the last amino acid apposition to the polypeptide molecule is called

45. Antibiotics are the ... of protein biosynthesis.

46. A segment of the DNA molecule and an albumine octamer form

47. The length of the DNA molecule decreases by ... times at the first level of the genetic material packaging.

48. The decrease of the DNA length by 10–20 times occurs at the ... level of packaging.

49. As a result of all packaging levels the DNP molecule is shortened by ... time.

50. ... contain the reserve information providing variability.

51. The genes-regulators carry information for the synthesis of such proteins as

52. During the structural genes «expression» genes-operators get rid of

53. The substance which is broken up as a result of enzyme activity coded in the given operon is

54. The combination of the «ligation» reactions of separate informative fragments of pre-mRNA with the mature mRNA formation is

55. Leber's disease is caused by the mutations of ... genes.

GENETIC ENGINEERING

56. Such enzymes as ... are used in the genetic engineering for the necessary genes isolation.

57. Enzymes capable of cutting the DNA molecule in certain sites forming «sticky ends» are called

58. The method of ... underlies the compound genes synthesis by means of the reverse transcription processes.

59. Bacterial plasmids, phages, viruses and ... can be vector molecules in genetic engineering.

60. Hybrid vectors capable of developing both as a phage and as a plasmid are called

61. The plasmids containing the cos-site (the sticky ends) of phage λ DNA are called

62. The DNA fragments with the dimensions of ... are possible to clone in the cosmide vectors.

63. The basic vector for the animal genes cloning is the genome of the virus

64. Restrictase Eco R I at the ledge cut forms ... in the DNA.

65. Restrictase Hind II in the break up amidst the identified recognized part of the nucleotid pairs forms ... in the DNA.

INHERITANCE REGULARITIES. INTERACTION OF GENES

66. The attributes with different qualitative states are called

67. Gene penentrance should comprise ... % for exhibiting Mendel's second and third laws.

68. Bombay phenomenon is an example of the genetic interaction which is called

69. Splitting by 9:7 phenotype at the heterozygotes results from ... of interallelic genetic interaction.

70. The result of the independent gene combination of two allelic pairs at the analyzing cross is the splitting in the first generation brooding by phenotype equal to

71. Type of the interallelic gene interaction in which the degree of attribute characteristic exhibiting depends on the amount of dominant genes in the genotype is called

72. Alleles presented in the populations more than in two states are called

LINKAGE OF GENES

73. Conditions limiting manifestation of Mendel's 3rd law are gene interaction, except for full domination, lethal and semilethal genes, unequal probability of gametes formation and zygotes of different types, pleiotropic action of genes, an incomplete penetrance of a gene and a

74. If diheterozygous organism forms only 2 types of gametes ... linkage of genes is present.

75. If diheterozygous organism forms 4 types of gametes ... linkage of genes is present.

76. If between the genes located in one pair of homologous chromosomes there is a crossing-over ... linkage of genes is present.

77. Biological phenomenon breaking the linkage of genes is called

78. The distance between genes in Morgan units is equal to % of

79. At the linked inheritance the maximal size of a crossing-over is ... %.

80. Individuals formed from crossover gametes are called

81. The number of human autosomal groups of linkage is

VARIATION

82. Enzymes capable of cutting out the damaged area of a molecule of DNA during reparation are called

83. Transgenation in which one purine base is replaced with another purine base is called

84. Circular chromosomes appear as a result of ... in the terminal parts of chromosomes.

85. Infringement of repression and induction phase sequences in the regulation of gene work occurs in case of mutation of ... genes.

86. Non-disjunction of chromosomes at mitosis or meiosis leads to ... mutations.

87. Type of aneuploidy when only one chromosome out of a pair of homologous chromosomes is present in karyotype is called

88. Type of genomic mutation when somatic cells contain a similar set of chromosomes is called

89. Disease caused by the infringement of mechanisms of reparation and is characterized by insufficiency of marrow functioning resulting in cellular blood elements deficit and hyperpigmentation is called

BIOLOGY AND GENETICS OF SEX

90. Detection in female somatic cell nuclei of two sex chromatin lumps proves a ... syndrome.

91. Female phenotypic signs, low auricle location alary neck skin fold are characteristic of a ... syndrome.

92. Men with a female type of body build, gynecomastia and infringement of spermatogenesis process suffer from a ... syndrome.

93. Phenomenon when sexual excitement and satisfaction are achieved at changing into the clothes of an inverse sex is called

94. Human chromosomal sex diseases result from the infringement of ... process.

95. Features determined by genes located in non-homologous part of Y-chromosome are called

96. Persistent discordance of person's sexual self-consciousness to his real genetic and gonadal sex is called

BASES OF HUMAN GENETICS

97. Man to start with medical genetic examination of family and compiling genealogy is called

98. A sick baby's birth probability from heterozygous parents at autosomal-dominant type of inheritance (complete dominance, gene penetrance 25 %) makes ... %.

99. Probability of sick baby's birth at X-linked dominant type of inheritance from a heterozygous mother and a healthy father (gene penetrance 40 %) makes ... %.

100. The method of ... nucleic acids allows to determine the order of nucleotides in a molecule of DNA and to find a pathologic gene.

101. Type of inheritance at which the father transmits his hereditary feature to all daughters, but neither to sons is called

102. Method of human genetic that allows to reveal the role of hereditation and environment in the formation of features is called

103. Genetic method that allows reveal genomic and chromosomal mutations is called

104. Revealing heterozygous carriers of a pathologic gene allows biochemical ... tests.

105. Chorion biopsy is performed on ... weeks of pregnancy.

106. Forecasting changes of genetic organization of human populations can be carried out by means of a ... method.

107. In Down's syndrome the fetus blood of a pregnant woman is marked to have a ... level of a-fetoprotein.

108. Each pregnant woman undergoes a compulsory ... — a direct non-invasive method of prenatal diagnostics.

109. Mother's age of over 37 years, spontaneous abortions in the anamnesis, stillbirth and children with congenital malformation are indications for carrying out ... methods of prenatal diagnostics.

110. Y-sexual chromatin is determined at staining of buccal epithelium cells by

111. The main palmar angle in norm shouldn't exceed

112. Human populations with the number not exceeding 1500 people within-which marriages surpass 90 % are called

113. Genetic load has no phenotypic manifestation in case if ... of a pathologic gene is observed.

HUMAN GENETIC AND CHROMOSOMAL DISEASES

114. Increased concentration of copper in blood in Wilson's disease, is invoked by mutation of the gene responsible for synthesis of protein

115. Sickemia educes owing to a mutation leading to replacement in a β -circuit 6th position of glutamic acid on

116. Increase of uric acid and its salts level in the body with present deficit of the enzyme, catalyzing apposition of purine bases to nucleotides, is a sign of a ... syndrome.

117. Hereditary deficiency of enzyme tyrosinase leads to the development of

118. Cerulloplasmine deficit results in the ... disease.

119. Genetic diseases caused by the infringement of blood plasma lipid exchange due to enzyme or cellular receptor defects are called

120. Mutations to changes of chromosome number or infringement of their structure invoke the development of ... diseases.

121. ... syndrome results from trisomy on the 18th pair of autosomes.

MEDICAL-GENETIC CONSULTATION

122. Substitutive therapy is an example of the ... treatment of inherited diseases.

123. Dietotherapy is an example of the ... treatment of inherited diseases.

124. Administration of anesthetizing preparations is an example of the ... treatment of inherited diseases.

125. Removal of the 6-th finger is an example of the ... treatment of inherited diseases.

126. Genetic therapy is an example of the ... treatment of inherited diseases.

REPRODUCTION OF ORGANISMS

127. Exchange of genetic information between individuals of one species is called

128. Confluence of female and male pronuclei during fertilization is called

129. Syngensis without fertilisation is called

130. Ovum, containing much yolk deposited on one of the poles, is called

131. Complete equable fragmentation is typical for ... ova.

132. During gametogenesis in the period of reproduction cells divide by the mechanism of

133. During gametogenesis in the period of maturation cells divide by the mechanism of

134. Asexual reproduction of fetus, as a result of syngensis, is called

135. Gamones, contributing to spermatozoon fixation on the ovum membrane, are called

136. Spermatozoons possess the ability of fertilization during

BASES OF ONTOGENESIS (EMBRYONIC DEVELOPMENT)

137. Mitotic division of zygote and blastomeres on the initial stage of embryogenesis is called

138. Period of human embryonic development from the beginning of the 4th week to the end of the 8th week after fertilization is called

139. Method of gastrulation, when particular cells of blastoderm move into the blastocoel, multiply there and conform the second layer of cells, is called

140. Organisms, in which blastopore transmogrifies into the anally opening and mouth forms on the opposite side of the body, are called

141. Amnion, chorion, allantois, yolk sac and placenta are ... organs of chordates.

142. Principle cause of differentiation of cells in the process of embryogenesis is ... of the ovum cytoplasm.

143. Impact of one group of embryo cells on the neighboring ones by excretion of certain substances is called

144. Gradual decrease of metabolism intensity in fetus from head to the tail part is called ... of physiological activity.

BASES OF ONTOGENESIS (POSTEMBRYONIC DEVELOPMENT)

145. Thymus and spleen are characterized by ... type of growth.

146. Specific role in regulation of a person's stature belongs to the hormone of hypophysis

147. Acceleration of physical and physiological development of children and teenagers, acceleration of sexual maturity and acceleration of growth is called

148. Stable, genetically determined peculiarities of morphology, physiology and behaviour of a man make his

149. People of ... constitutional type are predisposed to neuroses, ulcerous disease, tuberculosis.

150. Peculiarities of development, course, treatment and prevention of diseases of the elder by studies the science called

151. Science, which studies healthy life style, is called

152. Condition, when cardiac and respiratory failure, loss of consciousness are observed, but the metabolism isn't impaired, is called ... death.

153. Voluntary cessation of the life terminally ill people with the aid of a medical worker is called

INTRODUCTION TO PARASITOLOGY

154. Free-living organisms, which can be parasites in case of invading the organism of other species, are called

155. Hosts providing optimal biochemical conditions for the development of the parasite and which have biocoenotic relations with it, are called

156. Hosts providing biochemical conditions for the development of the parasite, but which don't have biocoenotic relations with it, are called

157. Hosts characterized by the presence of biocoenotic relations with parasites, but have no optimal biochemical conditions for their development, are called

158. Way of parasite invasion in to the host organism with water and foodstuffs is called

159. Way of parasite invasion in to the host organism through mucous membranes of respiratory pipes is called

160. Way of parasite invasion in to the host organism by immediate contact with a sick person or animal and with household objects is called

161. Way of parasite invasion in to the host organism when transfusing unsterile donor blood is called

PHYLUM SARCOMASTIGOPHORA, CLASSES SARCODINA, ZOOMASTIGOTA

162. Vegetative form of protista is called

163. «Melting» of mucous membrane of the large intestine with formation of bleeding ulcers 2,5 cm in diameter is a pathogenic effect of

164. Amoeba Limax cause inflammatory processes in the cerebrum and its membranes; the disease is called

165. Supporting centre, which some representatives of class Zoomastigota can have, is called

166. Specific carrier of African surra agent is

167. Trypanosoma ... has flagellar and non-flagellar forms in its life cycle.

168. Hyperemia and edema 10–15 cm in diameter, which develop on the site of Trypanosoma cruzi invasion into the derm, are called

169. Stage of life cycle of Leishmania donovani, which parasitizes in the carrier, is called

170. Trichomonas vaginalis has ... flagella.

PHYLUM INFUSORIA, CLASS CILIATA PHYLUM APICOMPLEXA, CLASS SPOROZOA

171. Pathogenic agent of tropical malaria is Pl.

172. Pathogenic agent of quartan is Pl.

173. Stage of the life cycle of malarial plasmodium, invasive for intermediate host in transmitting way of infection, is called

174. Final stage of development of malaria pathogenic agent in the human organism is called

175. Tape-like shizont are characteristic of Pl.

176. Semi-lunar gamonts are characteristic of Pl.

177. Specific formation on the arrow-headed end of toxoplasma, providing the parasite fixation to the host's cell, is called

178. Main hosts of toxoplasma are representatives of the family

179. Invasive stage of toxoplasma for the main host is ... and

180. Invasive stage of toxoplasma for intermediate hosts are ... and

PHYLUM PLATHELMINTHES, CLASS TREMATODA

181. Metacercaria, adolescaria or cercaria of flukes for the final host are
182. Fluke, in the hindquarter of which 2 rosette-like testicles are situated, between which an shaped curved secretory channel passes, is called
183. Life cycle of Cat liver fluke includes stages: egg → miracidium → sporocysts → redia → ... → metacercarium.
184. Fluke, which is egg-shaped and has an abdominal sucker somewhere in the middle of the body, is called
185. Larva of *Paragonimus westermani*, which is an invasive stage for the final host, is called
186. Special fillet for the localization of a female schistosome in a male schistosome is called
187. Life cycle of schistosomes includes stages: egg → miracidium → sporocysts I → ... → cercarium.
188. Larva of schistosomes, invasive for the final host, is called

PHYLUM PLATHELMINTHES, CLASS CESTOIDEA

189. From class of Tape worms contact helminth is
190. Hermaphrodite progottids of *Taeniarhynchus saginatus* have an ovary, consisting of ... sections.
191. Mature proglottid of *Taeniarhynchus saginatus* have... side branches.
192. *Taenia solium* is characterized by the finna of ... type.
193. Hermaphrodite progottids of *Taenia solium* have an ovary consisting of ... sections.
194. Mature proglottid of *Taenia solium* have... side branches.
195. Finna of *Hymenolepis nana* is called
196. Strobilus of *Hymenolepis nana* contains approximately ... proglottids.
197. Man is a ... host for *Echinococcus* and *alveococcus*.
198. Life cycle of *Diphyllobotrium latum* includes the following stages: ovum → ... → procercoïd → plerocercoid → adult individual.

PHYLUM NEMATHELMINTHES, CLASS NEMATODA

199. Symplastic tissue of Nematode's dermato-muscular sac is called
200. Body wall of roundworm consists of ... smooth muscle layer(s).
201. Contact helminth among roundworms is
202. Life span of mature *Ascaris* in the human body is about
203. Pig and dog *Ascaris* larva migrating in the human body cause ... syndrome.
204. Nematode with anterior end of the body is filament-like, the posterior — is thickened is called

205. *Enterobius vermicularis* life span in human organism is about
206. Following methods are used for the diagnosis of trichinellosis: ..., muscle digestion and immunological.
207. Funnel-like mouth capsule with 4 cuticular teeth on the head part is typical for
208. Noninvasive ancylostomas larvae with bulbus in the esophagus are called
209. Nematode with parasitic and free living stages in development cycle is called
210. Nodules covered with connective tissue capsule and containing dead or alive pubertal *Onchocerca volvulus* are called
211. Following methods can be used to reveal intact helminthes, their scolex and parts of their body in faeces:
212. Method of diagnosing helminthiasis using saturated sodium nitrate solution with specific gravity 1,4 is called
213. Method of diagnosing helminthiasis based on helminth's ovum heaving in saturated solution NaCl is called
214. Biopsy and muscle digestion, smear and thick blood drop, and ... refer to diagnostic methods of tissue helminthiasis.

PHYLUM ARTHROPODA, CLASS ARACHNOIDEA

215. Representatives of the family ... of acarians have eyes.
216. Ixodae family includes genuses *Ixodes*, *Hyalomma* and
217. Method of pathogen transmission from imago to larval stages through ovum is called
218. Ticks *I. ricinus* are pathogen carriers of ... and
219. Ticks *I. persulcatus* are pathogen carriers of
220. Ticks *D. pictus* are pathogen carriers of tularemia and
221. Ticks *D. marginatus* are pathogen carriers of tularemia, brucellosis and
222. Ticks *D. nutalli* are pathogen carriers of
223. *Hyalomma* acarians genuses are pathogen carriers of
224. Absence of dorsal shield and eyes, and presence of marginal welt are typical for acari family
225. Grain scabby is caused by ... acarian.

PHYLUM ARTHROPODA, CLASS INSECTA, ORDER DIPTERA

226. Fleas have the most important epidemiological significance because they are specific infection carrier of
227. Natural reservoir of the plague is
228. Plague pathogen in flea stomach breeds rapidly and forms

229. *Sarcopsylla penetrans* causes ... in man.
230. *Pediculus humanus capitis* and *Pediculus humanus humanus* cause ... in man.
231. *Phthirus pubis* causes ... in man.
232. Lice ova is called
233. Lice of *Pediculus* genus are specific infection carriers of pediculoses ... and
234. Pedicular louse relapsing fever pathogens are
235. Filth fly is a ... pathogen carrier of infectious and invasive diseases.
236. *Stomoxys calcitrans* is a mechanical pathogen carrier of ... and
237. *Glossina palpalis* is a specific infection carrier of
238. Human and animal diseases caused by some fly larvae (Wolffartov's, botflies), are called
239. Midges lay ova on
240. In tropical region midges are specific pathogen carriers of
241. Mosquitos are specific pathogen carrier of fever ... and
242. Winged blood-sucking insects consists of mosquitos, gadfly, midges and
243. Ovum maturation in a female gnats occurring only during blood digestion is called
244. Gnats of ... genus deposit ova in clean clear water reservoirs.

EVOLUTION OF ORGAN SYSTEMS

245. Phylembryogeneses, in which recapitulations are completely absent, are called
246. Ontophylogenetic mechanisms of congenital abnormalities are recapitulations and
247. Thin smooth skin without scales containing a great number of multicellular mucous glands and participating in gas exchange is typical for the class
248. Brain type in which corpus striatum of forebrain is the main integrative centre is called
249. Initiation of cranium cerebral section in the vertebrate originates from two sections: chordal (parachordals) and
250. Junction type of visceral and cerebral cranium through second branchial arch is called
251. Duodenum and rectum first appear in ... in evolution.
252. In fish ... joins atrium.
253. In amphibians ... develop from the sixth pair of branchial arteries.
254. In reptiles ... develop from the six pair of branchial arteries.

255. In mammals ... develop from the third pair of branchial arteries.
256. Lancelet organs of excretion are called
257. In adults pronephros functions only in
258. Mesonephros consists of approximately ... nephrons.

VENOMOUS ANIMALS

259. Actively poisonous animals with specialized venomous organs and injuring adaptations are called

260. According to physiological effect on living systems zootoxins are divided into neurotoxins, cytotoxins, hemorrhagins and

261. Venomous organs of Physaliae are

262. By physiological effect scorpion toxin refers to

263. By physiological effect karakurt toxin refers to

264. By physiological effect Brazilian spider toxins refer to cytotoxins and

265. By physiological effect Hymenoptera toxins refer to cytotoxins and

266. Poison of Colombian cocoa frog is more potent stronger than tetanus toxoid in ... times.

267. Viper snakes are primarily-venomous ... animals.

CLOSE TESTS

HUMAN IN THE SYSTEM OF NATURE

1. Organization levels of living matter are: a) molecular-genetic and cellular; b) tissue and colonial; c) subcellular and siphon; d) organism, biospheric and colonial; e) population-specious and biogeocenotic.

2. The substrate of life is the: a) complex of proteins and carbohydrates; b) complex of proteins and fats; c) complex of fats and carbohydrates; d) complex of fats and nucleic acids; e) complex of proteins and nucleic acids.

3. Living things as the open systems are characterized by: a) metabolism with the environment; b) absence of metabolism with the environment; c) energy exchange with the environment; d) absence of energy exchange with the environment; e) information exchange with the environment.

4. The human as the biological being is characterized by: a) heredity and variation; b) public mode of life; c) struggle for existence; d) metabolism, mentality and consciousness; e) presence of the second alarm system.

5. The human as the social being is characterized by: a) heredity, variation and mentality; b) presence of the second alarm system and public mode of work; c) metabolism, growth, development and ability to work; d) growth, development and ability to work; e) public mode of life and consciousness.

6. The human has following attributes of Mammals class: a) primary body cavity and teeth differentiation; b) mammary glands and diaphragm; c) hair covering and left arch of the aorta; d) diaphragm and dextral arch of the aorta; e) dextral arch of the aorta and intra-womb development.

7. The human has following attributes of Primates group: a) presence of nails; b) binocular eyesight and placenta presence; c) hair covering; d) opposition of the upper extremities thumbs; e) arms of catching type and teeth differentiation.

8. Species attributes of Homo sapiens (a reasonable man) are: a) high degree of brain development; b) mentality and consciousness, straight walking; c) presence of hair covering and nails; d) arms of catching type and straight walking; e) high opposition of the upper extremities thumbs.

BIOLOGY OF THE CELL. THE FLOW OF SUBSTANCE AND ENERGY IN THE CELL

9. Properties of elementary membrane are: a) plasticity; b) tightness and ability to flow; c) semi-permeability; d) elasticity; e) ability for self-locking.

10. Transport of substances into the cell demanding ATP energy is: a) receipt of ions into the cell by concentration gradient; b) phagocytosis; c) pinocytosis and diffusion; d) osmosis and endocytosis; e) receipt of substances into the cells against the concentration gradient.

11. Cell anabolic system organelles are: a) mitochondria and endoplasmic reticulum; b) ribosomes and Golgi's complex; c) endoplasmic reticulum; d) lysosomes and peroxisomes; e) glyoxysomes and ribosomes.

12. Cell catabolic system organelles are: a) mitochondria; b) ribosomes, glyoxysomes and endoplasmic reticulum; c) endoplasmic reticulum and mitochondria; d) Golgi's complex and peroxisomas; e) peroxisomas and lysosomes.

13. Ribosomes are located: a) on membranes of endoplasmic reticulum and in hyaloplasm; b) in hyaloplasm and karyoplasm; c) on internal nuclear membrane and in chloroplasts; d) on external nuclear membrane and in the mitochondria; e) in mitochondrial matrix and lysosomes.

14. Functions of the endoplasmic reticulum are: a) synthesis of proteins; b) DNA synthesis and compartmentalization; c) synthesis of fats and carbohydrates; d) compartmentalization and transport of substances; e) formation of peroxisomas and RNA synthesis.

15. Functions of Golgi's complex are: a) sorting, packing and secretion of substances; b) formation of lysosomes and complex organic substances compounds; c) synthesis of ATP, proteins and glyoxysomes; d) synthesis of cytoplasmic membranes; e) protein synthesis and substance secretion.

16. Functions of mitochondria are: a) synthesis of specific proteins; b) splitting of proteins into amino acids; c) synthesis of monosaccharides and ATP; d) synthesis of AMP (adenylic acid); e) splitting of organic substances into H_2O and CO_2 .

17. Anaerobic stage of energy metabolism occurs in: a) intestine; b) cytoplasm and mitochondria; c) cytoplasm and endoplasmic reticulum; d) cell cytoplasm; e) Golgi's complex and cell nucleus.

TEMPORAL ORGANIZATION OF THE CELL

18. In the pre-synthetic period of interphase occurs: a) synthesis of RNA, proteins and enzymes; b) synthesis of DNA, RNA, proteins and ATP; c) ATP synthesis and cell growth; d) accumulation of DNA nucleotides, synthesis of achromatic spindle proteins; e) synthesis of DNA, RNA and achromatic spindle proteins.

19. In the post-synthetic period of interphase occurs: a) synthesis of DNA and enzymes; b) synthesis of DNA, r-RNA, cell growth; c) ATP synthesis; d) accumulation of DNA nucleotides; e) synthesis of acromatic spindle proteins.

20. The content of cell genetic material at the end of synthetic period of interphase is: a) $1n$ $1chr$ $1c$; b) $1n$ $2chr$ $2c$; c) $2n$ $1chr$ $2c$; d) $2n$ $2chr$ $4c$; e) $1n$ $4chr$ $4c$.

21. Reasons of mitosis are: a) increase of nuclear-cytoplasmic ratio; b) decrease of nuclear-cytoplasm ratio; c) replication of DNA molecule and

«wound hormones»; d) «wound hormones» and mitogenetic rays; e) infringement of karyolemma integrity.

22. The content of cell genetic material in mitosis telophase is: a) 1n 1chr 1c; b) 1n 2chr 2c; c) 2n 1chr 2c; d) 2n 2chr 4c; e) 1n 4chr 4c.

23. Cells dividing by mitosis are: a) somatic; b) cells of gonads; c) gametogoniums; d) tumor cell; e) cells of regenerating tissues.

24. Cells dividing by amitosis are: a) somatic and old cells; b) cells of gonads and embryo; c) gametogoniums; d) tumor cells; e) cells of regenerating tissues.

25. Cells dividing by meiosis are: a) somatic and old; b) cells of gonads and embryo; c) gametocytes; d) tumor cells; e) cells of regenerating tissues.

26. Content of cell genetic material in meiosis I prophase is: a) 1n 1chr 1c; b) 1n 2chr 2c; c) 2n 1chr 2c; d) 2n 2chr 4c; e) 1nbiv 2chr 2c.

27. In meiosis I telophase occurs: a) spiralization of the chromatin and nucleolus dissolution; b) depolarization of chromosomes and nucleolus formation; c) formation of karyolemma; d) conjugation of chromosomes and crossing-over; e) cytokinesis.

BASES OF CYTOGENETICS

28. Karyotype is: a) monoploid complement of chromosomes; b) complement of somatic cell chromosomes; c) complement of gonad cell chromosomes; d) diploid complement of chromosomes; e) set of genes in diploid complement of chromosomes.

29. Ideogram is: a) unsystematized karyotype; b) systematized karyotype; c) genes location order in chromosome; d) nucleotides location order in gene; e) chromosomes karyotype arrangement by decreasing of their size.

30. Denver classification of human chromosomes takes into account: a) size of chromosomes; b) amount of chromatids; c) character of chromosomes coloring; d) centermeric index; e) centromere presence.

31. Centermeric index is: a) quantity of chromosome centromere; b) length ratio of the short and long chromosome arms; c) ratio of the short arm length and all chromosome length; d) length ratio of the long and short chromosome arm; e) ratio of the long arm length and all chromosome length.

32. Paris classification of human chromosomes takes into account: a) size of telomere; b) quantity of chromatids; c) character of chromosomes coloring; d) centermeric index; e) presence of secondary constriction and satellites.

33. Group A in Denver classification of human chromosomes includes: a) large submetacentric; b) small submetacentric; c) small metacentric; d) large metacentric; e) small acrocentric.

34. Group B in Denver classification of human chromosomes includes: a) large submetacentric, (TSI) 24–30; b) small submetacentric, (TSI) 24–30;

c) small metacentric, (TSI) 27–35; d) large metacentric, (TSI) 34; e) small acrocentric, satellite.

35. Group C in Denver classification of human chromosomes includes:

a) large submetacentric, (TSI) nearby 15; b) submetacentric of moderate size, (TSI) 27–35; c) small metacentric, (TSI) 36–46; d) large metacentric, (TSI) 27–35; e) small acrocentric, (TSI) 13–33.

36. Group D in Denver classification of human chromosomes includes:

a) large submetacentric, (TSI) 27–35; b) small metacentric, (TSI) 13–33; c) large metacentric, satellite; d) acrocentric of moderate size, (TSI) nearby 15; e) small acrocentric, (TSI) nearby 15.

37. Group E in Denver classification of human chromosomes includes:

a) large submetacentric; b) small submetacentric; c) small metacentric; d) large metacentric, X-chromosome; e) small acrocentric.

38. Group F in Denver classification of human chromosomes includes:

a) large submetacentric, (TSI) 36–46; b) small submetacentric, (TSI) 36–46; c) small metacentric, (TSI) 13–33; d) large metacentric, (TSI) 34, satellites; e) small acrocentric, (TSI) 13–33.

39. Group G in Denver classification of human chromosomes includes:

a) large submetacentric; b) small submetacentric and Y-chromosome; c) small metacentric, (TSI) 13–33; d) large metacentric, (TSI) 26–40; e) small acrocentric.

ORGANIZATION OF HEREDITARY MATERIAL

40. Amount of A+G is equal to amount of: a) A + T; b) C + T; c) G + T; d) A + C; e) G + C.

41. Complementary nucleotide pairs of DNA double chain are kept by following type of bond: a) hydrogen; b) covalent; c) phosphodiester; d) peptide; e) disulfide.

42. DNA functions are: a) storing and reproduction of the genetic information; b) transport of amino acids to ribosome; c) transmission of the genetic information to daughter DNA molecules; d) transport of amino acids; e) determination of r-RNA synthesis.

43. Functions of t-RNA are: a) storing of the genetic information; b) transport of amino acids to ribosome; c) transfer of the genetic information to daughter t-RNA molecules; d) direct participation in gathering of polypeptide molecules; e) transfer of the genetic information from DNA to the ribosome.

44. Gene properties are: a) stability and lability; b) integrity and pleiotropia; c) integrity, specificity and unambiguity; d) discretion and absence of specificity; e) specificity, tripletness and universality.

45. Specificity is the gene property to: a) mutate; b) determine synthesis of the certain polypeptide; c) be responsible for exhibiting several characters;

d) vary the degree of its phenotypic manifestation; e) have different frequency of phenotypic manifestations.

46. Pleiotropia is the gene property to: a) mutate; b) determine synthesis of the certain polypeptide; c) be responsible for exhibiting several characters; d) vary the degree of its phenotypic manifestation; e) have different frequency of phenotypic manifestations.

47. Elementary structural gene unit is: a) nitrogenous base; b) pair of complementary nucleotides; c) codon; d) one nucleotide; e) triplet of the nucleotides.

48. Elementary functional gene unit is: a) one nucleotide; b) pair of complementary nucleotides; c) codon; d) transcript; e) triplet of the nucleotides.

49. Heterosynthetic gene function is: a) transcription and replication; b) translation and transcription; c) DNA replication and reparation; d) transformation and translation; e) only translation.

50. The genes are classified into: a) structural, modifiers and repressors; b) introns, exons and inhibitors; c) functional and structural; d) corepressors and operators; e) regulators and intensifiers.

51. The role of structural genes is to: a) contain the information about protein-repressor structure; b) contain the information about structure of the proteins-enzymes; c) contain the information about structure of the proteins-histones; d) contain the information about RNA structure; e) contain the information about structure of RNA and protein-repressor.

52. The role of functional genes is to: a) contain the information about protein-repressor structure; b) contain the information about structure of the proteins-enzymes; c) contain the information about structure of the proteins-histones; d) contain the information about m-RNA structure, regulate work of structural genes; e) contain the information about r-RNA structure.

53. The transcript consists of: a) exons and genes-operators; b) genes-operators and genes-regulators; c) structural gene and initiator; d) promoter, terminator and repressor; e) initiator and genes-regulators.

54. Processes happening during pre-mRNA maturing are: a) reading of nucleotides location order from one DNA chain; b) transfer of pre-mRNA in cytoplasm; c) enzyme destruction of pre-mRNA non-informative part; d) splicing of exons; e) splicing of introns.

55. Intron functions are: a) regulation of translation and DNA replication; b) regulation of transcription; c) participation in the crossing-over and regulation of translation; d) containing of supply information providing variability; e) regulation of translation.

56. Criteria of cytoplasmic heredity are: a) presence of splitting characters in fillies according to Mendel's laws; b) absence of splitting characters in fillies according to Mendel's laws; c) possibility to reveal linkage groups;

d) inheritance goes on mother's line; impossibility to reveal linkage groups;
e) identical results of recurrent crossings.

57. Features of human mitochondrial genome are: a) cycle DNA contains 16 500 pairs of nucleotides; b) cycle DNA contains 500 pairs of nucleotides and includes r-RNA genes; c) both chains are transcribed, contains gene of cytochrome b; d) one chain is transcribed; includes r-RNA genes; e) contains the information about 22 t-RNA, cycle DNA contains 160 pairs of nucleotides.

GENETIC ENGINEERING

58. The purpose of gene engineering is: a) designing of genetic structures according to a given plan; b) decoding of the nucleotide order of DNA site; c) creation of organisms with the new genetic program; d) revealing of bunches of coupling; sequenation of genes; e) construction of a chromosome genetic map.

59. The basic stages of gene engineering are: a) obtaining necessary genetic materials; b) construction of a chromosome genetic map; c) decoding of the nucleotide order of a DNA site and recombinant DNA building; d) selection of the transformed cells; e) incorporation of a recombinant DNA molecules in a chromosome.

60. Means of reception of genes for transplantation: a) synthesis of simple genes by chemical reactions; b) synthesis of genes on a molecule of protein; c) synthesis of complex genes by reverse transcription; d) construction of a genetic map of a chromosome; e) a cutting of genes by restrictases.

61. Recombinant DNA molecules can be received by methods of gene embedding in: a) a protein; b) bacteria plasmid; c) a virus genome; d) a lipid; e) a bacteriophage genome.

62. The enzymes used in gene engineering are the following: a) DNA-polymerase; b) lipase and restrictase; c) revertase and restrictase; d) restrictase and amylase; e) ligase.

63. By methods of gene engineering are received: a) the strains of Escherichia coli, capable to inulin synthesize; b) the strain of Escherichia coli, capable to somatotropinum synthesize; c) plants, capable to acquire atmosphere nitrogen; d) microorganisms, capable to synthesize carbohydrates of oil from alimentary proteins; e) antiviral serums.

64. The future of gene engineering is based on the following achievements of molecular biology: a) opportunities of genetic information transmission in eukaryote by sexual way; b) receiving of paravariations with help of chemical mutagenes; c) sequenation of genes; d) substitution of defective genes; e) including in human genome synthetically synthesized genes.

65. The chemical basis of plasmids is made of the following molecules: a) RNA; b) DNA; c) proteins; d) lipids; e) polysaccharides.

INHERITANCE REGULARITIES. INTERACTION OF GENES

66. The main features of G. Mendel's hybridological method are: a) one or of two pairs of alternative attributes is analyzed; b) many of alternative attributes are analyzed; c) analysis starts with cross of homozygous organisms; d) hybrids of several generations are analyzed; e) hybrid of just one generation is analyzed.

67. Positions of a hypothesis of «purity of gametes»: a) genes of one allelic pair of a hybrid organism are hybridized; b) genes of one allelic pair of a hybrid organism are not hybridized; c) genes of different allelic pairs can be hybridized; d) both allelic genes get in one gamete; e) from each pair of allelic genes one gene gets into gamete.

68. The conditions necessary for exhibiting of laws of Mendel: a) co-dominance; b) semidominance; c) presence of lethal genes; d) the mechanism of equiprobable formation of gametes and zygotes of a different type; e) genes of different allelic pairs are in one chromosome.

69. Analyzing cross is used to reveal: a) mutations; b) a phenotype of the individual; c) a genotype of the individual with a recessive character; d) a genotype of the individual with dominant character; e) lethal genes.

70. The characteristic of incomplete domination: a) the dominant gene does not completely suppress the action of a recessive gene; b) the dominant gene completely depresses the action of a recessive gene; c) homo- and heterozygotes are indistinguishable phenotypically; d) homo- and heterozygotes are identical phenotypically; e) the dominant gene in a heterozygous state is shown stronger, than in homozygous.

71. The characteristic of co-domination is: a) the dominant gene does not completely suppress the action of recessive gene; b) it is a type of interaction of allelic genes, genes are equivalent; c) homo- and heterozygotes are indistinguishable phenotypically; d) it is a type of interaction of not allelic genes; e) the dominant gene in a heterozygous state is shown stronger, than in homozygous.

72. The characteristic of polymeria is: a) mutual influence of genes of different alleles, that occupy the neighboring locuses of one chromosome; b) presence of 2 dominant genes from different allelic pairs leads to exhibiting of a new attribute; c) presence of 2 recessive genes from different allelic pairs leads to exhibiting of a new attribute; d) one gene influences the exhibiting of different attributes; e) genes from different allelic pairs influence a degree of manifestation of one character.

LINKAGE OF GENES

73. The phenomenon of linkage is observed in locating of genes of different allelic pairs: a) in one chromosome; b) in different chromosomes; c) only in autosomes; d) only in X-chromosome; e) only in a Y-chromosome.

74. Complete linkage of genes is observed: a) in females of *Drosophila* and the male of a silkworm; b) if genes of different allelic pairs are located in different chromosomes; c) if there is a crossing-over; d) if there is no crossing-over; e) in males of *Drosophila* and female of a silkworm.

75. Incomplete linkage of genes is observed: a) if genes of different allelic pairs are located in one chromosome; b) if genes of different allelic pairs are located in different chromosomes; c) if there is a crossing-over; d) if there is no crossing-over; e) in males of *Drosophila* and the female of a silkworm.

76. The main provisions of the chromosomal heredity theory are: a) allelic genes are located in the linear order in identical locus's of homologous chromosomes; b) allelic genes occupy different locus's of homologous chromosomes; c) the number of linkage groups is equal to monoploid set of chromosomes; d) the number of linkage groups is equal to diploid set of chromosomes; e) between homologous chromosomes of *Drosophila* male the crossing-over is possible.

77. Phenotype splitting for monohybrid cross of homozygotes at complete dominance: a) is absent; b) 3:1; c) 1:2:1; d) 9:3:3:1; e) 1:1.

78. Phenotype splitting for incomplete linkage of genes in Morgan's experiences: a) 3:1; b) 1:2:1; c) 9:3:3:1; d) 1:1; e) 41,5:8,5:8,5:41,5.

79. Phenotype splitting for complete linkage of genes in Morgan's experiences: a) 41,5:8,5:8,5:41,5; b) 3:1; c) 1:2:1; d) 9:3:3:1; e) 1:1.

SPLITTING FOR VARIATION

80. The properties of modifications: a) have adaptive character; b) are inherited; c) are not inherited; d) are a stuff for natural selection; e) are a stuff for artificial selection.

81. Biological mutagens produce: a) structure infringement of genes and chromosomes; b) a polyploidy; c) formation of thymine dimers; d) haploid; e) embedding of its DNA in DNA of host cells.

82. Characteristic attributes of gametic mutations are: a) occur in sex cells; b) occur in somatic cells; c) show at the individual; d) are transferred to offsprings offsets at a syngensis; e) are transferred to offsprings at an asexual reproduction.

83. Kinds of functional genes mutations: a) a transposition; b) infringement of alternating recognition and terminations; c) infringement of alternating initiation and elongation; d) impairment of alternating of an induction and repression; e) transitions.

84. The polyploidy is: a) not multiple monoploid augmentation of chromosome number; b) multiple monoploid augmentation of chromosome number; c) not multiple monoploid decrease of chromosome number; d) multiple monoploid decrease of chromosome number; e) a unary set of chromosomes.

85. Haploidy is: a) a positive mutation; b) nullsomy; c) monosomy; d) absence of one chromosome; e) a unary set of chromosomes.

86. Kinds of structural genes mutations: a) transductions; b) a transposition; c) translocations; d) alteration of a reading frame; e) transitions.

87. Sequence of dark stages reparations of a genetic stuff: 1) synthesis of a new field of DNA; 2) «ligation» of the synthesized field of DNA with the main strand; 3) «the recognition» the damaged field; 4) «cutting» of the damaged field; 5) replication of a DNA molecule; a) 1–5–2–3; b) 5–1–3–2; c) 3–4–5–2; d) 3–4–2–1; e) 3–4–1–2

88. In a basis of a carcinogenesis according to the concept of oncogene lays: a) protooncogenes are received from parents or introduced into the cell by viruses; b) chromosome mutations of somatic cells; c) presence of protooncogenes in somatic cells of an organism; d) genomic mutations of somatic cells; e) incorporations of virus DNA in genome of somatic cells.

BIOLOGY AND GENETICS OF SEX

89. The germ formation of gonads occurs on the week of embryogenesis: a) 1st; b) 2nd; c) 3rd; d) 4th; e) 5th.

90. The differentiation of germs into gonads occurs on the following weeks of embryogenesis a) from 1st to 4th; b) from 4th to 6th; c) from 4th to 8th; d) from 4th to 12th; e) from 10th to 15th.

91. Till 4th week of an embryogenesis the germ formation of gonads goes under the control of genes of: a) autosomes; b) one X-chromosome; c) two X-chromosomes; d) Y-chromosomes; e) X-and Y-chromosomes.

92. The germ differentiation into gonads occurs under the control of genes of: a) autosomes; b) one X-chromosome; c) the second X-chromosome; d) Y-chromosomes; e) cytogene.

93. At absence in karyotype of the second gonosome gonads: a) are differentiated; b) are not differentiated; c) connective tissues are formed on their place; d) atrophy partially; e) atrophy completely.

94. Physical abnormality in the determination of sex in human: a) a genetic gender; b) homosexuality; c) transvestism; d) gametic gender; e) hermaphroditism.

95. Transvestism is the phenomenon, when the person: a) chooses the sexual partner of other gender; b) chooses the sexual partner of the same gender; c) the sexual satisfaction is reached during putting on clothes of the opposite gender; d) wishes to change his/her gender; e) infertile.

96. Record of the karyotype at Turner's syndrome is : a) 46, XY, 5p-; b) 45, X0; c) 47, XXY; d) 47, XX, 21 +; e) 46, XX, 9p +.

97. Record of the karyotype at Klinefelter's syndrome is : a) 47, XXY; b) 45, X0; c) 47, XXX; d) 46, XY; e) 46, XY, 9p +.

98. A Barr's body is: a) an activated Y-chromosome; b) inactivated Y-chromosome; c) activated X-chromosome; d) inactivated X-chromosome; e) inactivated X-and Y-chromosomes.

BASES OF HUMAN GENETICS

99. The difficulty to study human genetics is: a) simple karyotype; b) early puberty; c) small amount of offsprings; d) a plenty of offsprings; e) an experimentation opportunity.

100. The stages of genealogic analysis: a) the collecting of the anamnesis; b) definition of frequencies of genes and genotypes in a population; c) construction of a genetic map of chromosome; d) studying of a role of the environment in exhibiting of attribute; e) analysis of a family tree.

101. Sequence of cytogenetic method stages: 1) processing of the cells by hypotonic solution NaCl; 2) a staining of chromosomes; 3) a stop of mitosis (colchicines) at a stage of a metaphase; 4) cultivation of cells on artificial nutrient mediums; 5) stimulation of mitosis by PHA. a) 1-5-3-4-2; b) 4-5-3-1-2; c) 4-1-5-3-2; d) 5-3-4-1-2; e) 4-5-1-3-2.

102. Holsinge's formula is used for calculation: a) frequencies of genes and genotypes in a population; b) quotient of inheritance; c) roles of environment in exhibiting an attribute; d) probabilities of inheritance; e) degree of genetic risk.

103. Biochemical methods of human genetics are studying: a) the general blood analysis; b) activity of enzymes of a blood plasma; c) activity of enzymes of a gastric juice; d) structure of primary urine; e) regional frame of enzymes.

104. Methods of recombinant DNA are based on: a) use of mathematical expression of the law of Hardy-Weinberg; b) opportunities of abjection of DNA fragments and an establishment sequence of nucleotides in them; c) construction and analysis of family trees; d) studying of enzyme systems activity; e) microscopic karyotype studying.

105. Methods recombinant DNA allow: a) to isolate separate genes and their parts; b) to reveal genomic mutations; c) to create unlimited amount of copies of genes; d) to reveal chromosome mutations; e) to reveal phylum of inheritance.

106. Characteristic attributes of an ideal population are: a) great number; b) small number; c) complete panmixia; d) absence of mutations; e) presence of mutations.

107. In mathematical expression of the law of Hardy-Weinberg p designates frequency of: a) dominant gene; b) recessive gene; c) dominant homozygotes; d) recessive homozygotes; e) heterozygotes.

108. In mathematical expression of the law of Hardy-Weinberg q designates frequency of: a) dominant gene; b) recessive gene; c) dominant homozygotes; d) recessive homozygotes; e) heterozygotes.

109. In mathematical expression of the law of Hardy-Weinberg $2pq$ designates frequency of: a) dominant gene; b) recessive gene; c) dominant homozygotes; d) recessive homozygotes; e) heterozygotes.

110. Microbiologic tests give the ability to: a) build genetical maps of human chromosomes; b) determine amount of X-chromosomes; c) determine amount of Y-chromosomes; d) reveal some chromosome mutations; e) reveal some metabolism defects.

111. Dermatoglyphic analysis gives the ability to: a) study of pathogeny of skin diseases; b) develop measures for prophylaxis of skin diseases; c) establish the causes of originating of skin diseases; d) reveal hereditary components of disease; e) diagnose metabolism defects.

112. Direct noninvasive methods of prenatal diagnostics are: a) the definition of alpha-fetoprotein; b) the ultrasonography; c) the chorionbiopsy; d) the aminoicentesis; e) the fetoscopy.

113. Optimum terms for carrying out direct noninvasive methods of prenatal diagnostics are: a) 6–8 weeks; b) 8–10 weeks; c) 12–20 weeks; d) 23–30 weeks; e) 30–35 weeks.

114. The genetic load is: a) population saturation by positive mutations; b) population saturation by mutations, reducing adaptability of separate individuals; c) population saturation by neutral mutations; d) population saturation by negative mutations; e) absence of mutations in populations.

HUMAN GENETIC AND CHROMOSOMAL DISEASES

115. Diagnostic attributes of phenylketonuria are: a) «mice» smell, the intellect is not disturbed; b) hypererethism and hypertone of muscles, mental retardation; c) hypoerethism and hypotone of muscles, reduced skin pigmentation; d) convulsive epileptiform attacks, hemorrhages in joints; e) increased contents of phenylalanine hydroxylase in the blood.

116. Diagnostic attributes of albinism are: a) hyposensitivity to ultraviolet rays; b) milky-white skin color; c) hair depigmentation; d) hair pigmentation; e) decreased sharpness of vision.

117. Diagnostic attributes of galactosemia are: a) jaundice of newborns; b) vomiting, diarrhea, augmentation of liver and lien; c) depigmentation of skin and hair; d) propensity to self-damages; e) mental retardation.

118. Diagnostic attributes of illness of Wilson-Konovalov are: a) increased copper content in blood; b) increased iron content in blood; c) copper accumulation in tissues of liver and brain and their subsequent involution; d) iron accumulation in tissues of liver and brain and their subsequent involution; e) infringement of functions of liver and central nervous system.

119. Diagnostic attributes of hemophilia A are: a) time of blood coagulation — 5–6 minutes; b) nasal bleedings and paralysis of lower extremities; c) plural hematomas; d) hemorrhages in large joints and intellect decrease; e) blood in urine and high arterial pressure.

120. The karyotype for Patau's syndrome is: a) 47, XXY; b) 47, XX, 18+; c) 47, XXX; d) 48, XYY; e) 47, XY, 13+.

121. Diagnostic attributes of Edward's syndrome are: a) macrocephaly; b) congenital heart defects; c) big lower jaw and mouth opening; d) throat underdevelopment; e) «rocking foot».

122. The karyotype for Down's syndrome is: a) 45, XX, 21-; b) 47, XY, 13+; c) 47, XX, 21+; d) 47, XY, 21+; e) 46, XX, 5r-.

123. The karyotype for «Cat's cry» syndrome: a) 45, XX, 5-; b) 46, XY, 5-; c) 47, XX, 18+; d) 47, XY, 5+; e) 46, XX, 5r-.

MEDICAL-GENETIC CONSULTATION

124. The main aims of medical-genetic consulting are: a) the establishment of a genetic risk degree in the examined family; b) frequency decrease of all diseases; c) frequency reduction of genetic caused diseases; d) frequency reduction of congenital developmental anomalies; e) increase of birthrate.

125. High genetic risk is: a) up to 5 %; b) 5–10 %; c) 10–20 %; d) 20–30 %; e) about 50 %.

126. Indications to direct the family on medical-genetic consultation are: a) presence of similar hereditary diseases at several family members; b) physical retardation of the child; c) infection disease appearance in the family; d) parasitic disease appearance in family; e) divorce of spouses.

127. Application examples of symptomatic treatment of hereditary pathology are: a) pain killers in inflammatory processes; b) antibiotics in pain syndrome; c) sedatives in hypererethism; d) exception of non metabolic substance from the diet; e) surgical correcting of congenital defects.

128. Hereditary diseases, corrected by special diets are: a) Down's syndrome; b) phenylketonuria; c) mucoviscidosis; d) galactosemia; e) Duchenne's myodystrophy.

129. Application examples of pathogenic treatment of hereditary pathology are: a) pain killers in a pain syndrome; b) metabolic inhibition; c) genetic therapy; d) exception of non metabolic substance from the diet; e) restriction of non metabolic substance in the diet.

130. Application examples of etiological treatment of hereditary pathology are: a) metabolic inhibition; b) antibiotics; c) replacement therapy; d) exception of non metabolic substance from the diet; e) genetic therapy.

131. Metabolic inhibition includes: a) restriction of substance receipt with the food; b) accelerated removal of pathological reaction substrate from organ-

ism; c) compensation of not synthesized product; d) suppression of pathological substrate synthesis; e) organ protection against receipt of catabolism products surpluses.

REPRODUCTION OF ORGANISMS

132. Asexual reproduction characteristic is: a) two individuals participate in reproduction; b) one individual participates in reproduction; c) the genotype of daughter individual differs from parental ones; d) the genotype of daughter individual is identical to parental ones; e) the number of daughter individuals increases slowly.

133. Asexual reproduction forms of metazoans are: a) by vegetative organs; b) conjugation; c) copulation; d) polyembryony; e) fragmentation.

134. Sexual reproduction characteristic is: a) two individuals participate in reproduction; b) one individual always participates in reproduction; c) the genotype of daughter individual differs from parental one; d) the genotype of daughter individual is identical to parental ones; e) the number of daughter individuals increases quickly.

135. Sexual process is: a) the reproduction; b) the fusion of two gametes; c) formation of gametes; d) genetic information exchange between same species individuals; e) genetic information joining of same species individuals.

136. Isolecital ova characteristics: a) contains a lot of yolk; b) contains small amount of yolk; c) the yolk is evenly distributed; d) the yolk is concentrated on the vegetative pole; e) the yolk is located on the animal pole.

137. Progression of spermatozoons in female sexual ways is provided by: a) motility of spermatozoons; b) ova unmotility; c) contraction of uterus muscles; d) excretion of gynogammons; e) contraction of bladder muscles.

138. Fertilization stages are: a) ova destruction by spermatozoons hyaluronidase; b) the acrosome reaction; c) ova splitting; d) permeation of head, neck and tail of spermatozoon in ova cytoplasm; e) maturing of pronucleuses.

139. Features of human reproduction are: a) women are capable for reproduction from the puberty up to advanced age; b) men are capable for reproduction from the puberty up to 50 years; c) one oocyte of the second order is formed ones a moon month in women; d) spermatozoons are formed periodically in men; e) than older is the man, the greater is time interval between meiosis-1 and meiosis-2.

BASES OF ONTOGENESIS (EMBRYONIC DEVELOPMENT)

140. The type of zygote splitting depends on: a) ova sizes; b) ova form; c) yolk quantity; d) yolk location; e) potentialities of ova cytoplasm.

141. Dermatome derivatives are: a) intestine epithelium; b) nervous system; c) respiratory system; d) urinogenital system; e) derma.

142. First causes of cells differentiation during embryogenesis are: a) chemical homogeneity of the ovum cytoplasm; b) chemical heterogeneity of the ovum cytoplasm; c) chemical homogeneity of spermatozoon cytoplasm; d) chemical heterogeneity of spermatozoon cytoplasm; e) different possibilities of animal and vegetative poles of the ovum.

143. Realization of genes action during ontogenesis is: a) DNA → protein-enzyme → mRNA → biochemical reaction → attribute; b) DNA → mRNA → protein-enzyme → biochemical reaction → attribute; c) other genes influence on attribute exhibiting; d) other genes do not influence attribute exhibiting; e) environmental factors do not influence on attribute exhibiting.

144. The main mechanisms of cells differentiation are: a) blocking of different transcriptones at the certain development stage; b) incorporation in the work of all genes at the certain development stage; c) blocking of all genes at the certain development stage; d) unblocking of different transcriptones at the certain development stage; e) blocking of one gene at the certain development stage.

145. Characteristic attributes of totipotent cells are: a) their development is programmed; b) their development is not programmed; c) each of them can give rise to any cell type; d) each of them can give rise only to the certain cell type; e) the majority of transcriptones are blocked.

146. Characteristic attributes of determined cells are: a) their development is finally programmed; b) their development is not programmed; c) each of them can give rise to any cell type; d) each of them can give rise only to the certain cell type; e) the majority of genes blocks can join in the work.

147. The causes of embryogenesis critical periods are: a) change of conditions of embryo existence and feeding; b) transition from one development period to another one; c) appearance of new inducers; d) active dedifferentiation of cells; e) insufficient nourishment of the pregnant woman.

BASES OF ONTOGENESIS (POSTEMBRYONIC DEVELOPMENT)

148. Critical periods of a postnatal ontogenesis of the person: a) labors; b) new born; c) puberty; d) sexual withering; e) senile age.

149. The Characteristic of cerebral phylum of body height of organs and tissues of a human being: a) intensive body height since birth and till 10–12 years; b) uniform body height during the whole period; c) intensive body height in the first year of life and during puberty; d) intensive body height till 11–12 years, then decrease of volume of a tissues up to a level of an adult organism; e) a tachyauxesis during puberty.

150. Criteria of biological age: a) a degree of development of a scalp; b) the dimensions of genitals; c) skeleton maturity ;d) body height of the person; e) dental maturity.

151. The Constitution of the person is: a) hereditary features of morphology, physiology and behaviour; b) a momentary state of the person; c) persistent, genetically caused disturbances of morphology, physiology and behaviour; d) a reactivity; e) resistibility to disease-producing agents.

152. Hypersthenic persons are predisposed to: a) to neuroses; b) hypertension; c) stomach ulcer; d) atherosclerosis; e) obesity.

153. The essence aging of intoxicating hypothesis: a) changes of cytoplasm colloidal properties; b) decrease in production of sexual hormones; c) accumulation of waste products in large intestine and their adsorption in blood; d) disturbance of adaptation and regulation processes; e) accumulation of mutations.

154. The essence aging of genetic hypothesis: a) changes of colloidal properties of a cell cytoplasm; b) decrease in production of sexual hormones; c) impairment of reparation and DNA replication processes; d) impairment of adaptation and regulation processes; e) genetically programmed number of cell's mitosis.

155. The proof of genetically programmed number of cell's mitoses is: a) fibroblasts of man's embryos in culture give about 50 generations; b) at each DNA replication some nucleotides of telomeres are lost; at each DNA replication some nucleotides of telomeres are added; c) with each mitosis the length of telomeres decreases; d) with each mitosis the length of telomeres increases.

INTRODUCTION TO PARASITOLOGY

156. The Parasitism — such a cohabitation of different kinds of organisms, at which: a) organisms receive mutual benefit; b) the individual of one species uses the individual of other species only as habitation; c) the individual of one species uses the individual of other species as habitation and the source of nutrition, not causing any harm; d) the individual of one species uses the individual of other species as dwelling and the source of nutrition and harms her; e) none of the organisms receive any benefit.

157. Examples of parasites progressive morpho-physiological adaptation are: a) the presence of organs of bracing and special integuments of a body (the cuticle, tegument); b) simplification of the nervous system a constitution and sense organs; c) molecular «mimicry» and anti-enzymes discharge; d) a reduction of the tape worms alimentary system; e) a high fertility and intricit development of cycles.

158. Examples of biological acclimatization of parasites: a) presence of organs of bracing and anti-enzymes; b) simplification of the nervous system and sense organs constitution; c) perfection of various forms of an asexual reproduction and a high fertility; d) complex cycles of development, change of host and larvae migration over an organism of the host; e) immunosuppressive action.

159. Pathogenic action of the parasite: a) mechanical damage of organs and tissues and toxic-allergic; b) supply of the host by vitamins; c) supply of the host by nutrients; d) absorption of nutrients and vitamins from the organism of the host; e) opening a gate for a secondary infection.

160. Pathogenicity of a parasite does not depend on: a) the host genotype and factors of the environment; b) the genotype and virulence of a parasite; c) the host age and a feeding schedule; d) body height and a sex of the host; e) presence of other parasites in the host.

161. Levels of defense reactions in host organism are: a) subcellular and cellular; b) cellular and organism; c) both specific and histic; d) cellular and histic; e) population-specific.

162. Adaptation of parasites at the population level: a) presence of cyst and active search of host's; b) simplification of the nervous system constitution and the reduction of the alimentary system in tape worms; c) molecular «mimicry» and anti-enzymes discharge; d) involving of intermediate and reservoir hosts in to the development cycle; e) synchronization parasite development cycles and hosts behavior.

PHYLUM SARCOMASTIGOPHORA, CLASSES SARCODINA, ZOOMASTIGOTA

163. Sequence of stages of dysenteric ameba development cycle is: a) forma minuta → forma magna → tissue → cyst → forma magna ;b) forma magna → forma minuta → tissue → cyst → forma magna; c) the cyst → forma minuta → forma magna → tissue → forma magna; d) cyst → forma minuta → forma magna → tissue → forma minuta → cyst; e) histic → forma magna → forma minuta → the cyst.

164. Laboratory diagnosis of the American trypanosomiasis is based on: a) detection of trypanosomes in excrements and duodenal contents; b) immunological methods; c) detection of trypanosomes in blood smears; d) trypanosome detection in a neurolymph and in puncture specimens of the lymph nodes; e) trypanosome detection in skin sections and hypodermic tissues.

165. Diagnostic features of a visceral leishmaniasis are: a) fever, asthenia, a headache; b) a water bloody stool; c) anemia and an cachexia; d) enlargement of the liver and the spleen; e) pains along the small intestine.

166. Characteristic features of Acanthamoeba are: a) narrow long pseudopodia; b) short wide pseudopodia; c) do not form cysts in unfavorable conditions; d) trophozoite with two flagellum; e) have no flagellate form, in unfavorable conditions form cysts.

167. Reservoir hosts of African trypanosomiasis originators are: a) sick people and monkeys; b) cattle stock; c) dogs and wolves; d) opossums and armadillos; e) pigs and antelopes.

168. Diagnostic features of the African trypanosomiasis are: a) drowsiness, fever, an cachexia; b) a bloody diarrhea; c) a cardio muscular lesion; d) the liver and spleen enlargement; e) trypanosomic chancre on the skin, lymph nodes enlargement on the back of the head occiput.

169. Characteristic features of pathogenic action of cutanomucous leishmaniasis agent are: a) a skin lesion only; b) a skin, mucosa and cartilage lesion; c) a lesion of internals; d) involving a secondary infection; e) vision and hearing impairment.

170. Diagnostic features of lambliasis are: a) decrease of appetite and nausea; b) a headache and drowsiness; c) pains in epigastrium and in dextral subcostal area; d) pains in left subcostal area; e) a unstable stool.

**PHYLUM INFUSORIA, CLASS CILIATA
PHYLUM APICOMPLEXA, CLASS SPOROZOA**

171. Sequence of stages of the malaria development in preerythrocyte schizogonies is: a) sporozoits → blood schizonts → tissue schizonts → tissue merozoites; b) sporozoits → tissue schizonts → blood schizonts → tissue merozoites; c) sporozoits → tissue schizonts → tissue merozoites; d) blood schizonts → sporozoits → gametocytes; e) sporozoits → blood schizonts → tissue schizonts → gametocytes.

172. Sequence of stages of the development in erythrocytic schizogonies is: a) ring-shaped schizont → amoeboid schizont → gametocyte → rounded schizont → blood merozoite; b) rounded schizont → blood merozoite → gametocyte → ring-shaped schizont → amoeboid schizont; c) amoeboid schizont → ring-shaped schizont → rounded schizont → gametocytes → blood merozoite; d) ring-shaped schizont → amoeboid schizont → rounded schizont → blood merozoite → gametocyte; e) gamentocyte → rounded schizont → ring-shaped schizont → amoeboid schizont → blood merozoite.

173. Sequence of gametogonium stages in man malaria agent is: a) oocytes → gametocyte → macro-and microgametes → zygote → ookinete b) gametocytes → macro-and microgametes → zygote → ookinete; c) macro-and microgametes → ookinete → zygote → gametocytes; d) macro-and microgametes → zygote → ookinete → gametocytes; e) gametocytes → zygote → ookinete → macro-and microgametes.

174. Sequence of sporogonium stages of malaria agent in man is: a) micro- and macrogamete → ookinete → oocyte → sporozoites → tissue merozoites; b) ookinete → oocyte → sporozoites → tissue merozoites; c) oocyte → sporozoites → tissue merozoites; d) oocyte → ookinete → sporozoites e) oocyte → sporozoites.

175. Sequence of symptoms exhibiting during an malaria attack is: a) abundant perspiration → chill → fever; b) chill → abundant perspiration →

a fever; c) fever → chill → abundant perspiration; d) chill → fever → abundant perspiration; e) fever → abundant perspiration → chill.

PHYLUM PLATHELMINTHES, CLASS TREMATODA

176. The Female sexual system of flukes includes: a) spermaries, ovaries and uterus; b) ovaries, yolk glands and cirrus; c) ovaries, uterus, yolk glands and spermatheca; d) ovaries, spermatic vessels and uterus; e) an ootype, cirrus and yolk glands.

177. The First mediate hosts of flukes are: a) man and monkeys; b) cattle stock; c) cats and dogs; d) molluscums; fish, e) fishes, shrimps and crabs.

178. The Second mediate hosts of flukes are: a) may not be present; b) cattle stock; c) wild boars and house pigs; d) molluscums; e) fish, shrimps and crabs.

179. Laboratory diagnostics of fascioliasis is based on: a) detection of eggs in the phlegm and urine; b) detection of eggs in duodenal contents and excrements; c) immunological methods; d) radiological examination of the liver and pancreas; e) detection of maritas in excrements and duodenal content.

180. Methods of laboratory opistorchosis diagnosis are: a) Fulleborn and Kalantarjan; b) Gorachev; c) twistings by Schulman; d) native and thick blood film with cellophane; e) a sticky tape.

181. Laboratory diagnosis of a paragonimiasis is based on: a) detection of eggs in excrements and urine; b) detection of eggs in excrements and sputum; c) detection of larvae in excrements and sputum; d) detection of marits in the lung and liver; e) immunologic methods and roentgenoscopic examination of the lungs.

182. In urinogenital schistosomosis: a) the mesentery veins and the wall of the small intestine; b) veins of the uterus and the top third of the vagina; c) veins of the bladder and prostate; d) veins of the large intestine; e) veins of the lungs — are damaged.

183. In Menson schistosomosis: a) veins of the mesentery and the intestine; b) veins of the uterus and the vagina; c) veins of the bladder; d) the system of the portal vein of the liver and the liver itself; e) the brain — are damaged.

PHYLUM PLATHELMINTHES, CLASS CESTOIDEA

184. Sequence of tapeworm life cycle stages is: a) ovum → coracidium → proceroid → oncosphere → plerocercoid; b) ovum → oncosphere → the Finn; c) ovum → coracidium → proceroid → plerocercoid; d) cercarium → coracidium → proceroid → the Finn; e) proceroid → metacercaria → plerocercoid.

185. Means of teniasis infestation of man are: a) personal hygiene neglect; b) contacts with teniasis and cysticercosis patients; c) the usage of thermal-

ly insufficient beef; d) the usage thermally insufficient pork; e) the usage thermally insufficient processed fish, shrimps and crabs.

186. Means of cystiercosis infestation of man are: a) swallowing of armed tapeworm eggs neglecting personal hygiene; b) the usage of thermally insufficient pork and beef; c) the usage of thermally insufficient shrimps and crabs; d) contact with house pigs; e) autoinvasion in teniasis.

187. Pathogenic action of *Taeniarchynchus saginatus* is: a) brain and a spinal cord lesion; b) toxi-allergic; c) large intestine mucosa irritation; d) small intestine mucosa irritation; e) absorption of nutrients from the host intestine.

188. Diagnostic signs of *Taeniarchynchus* invasion are: a) bloody fluid stool; b) fever and gastric pains; c) gastric pains, nausea, vomiting; d) difficulty of respiration, a pains in the thorasic cavity; e) liver and spleen enlargement.

189. Invasion alveococci stage for man is: a) ovum; b) oncosphere; c) plerocercoid; d) cysticeroid; e) cysticercus.

190. Means of alveococcosis infestation of man are: a) neglect of personal hygiene after contacts with sick people; b) neglect of personal hygiene after contacts with carnivores; c) the usage of thermally insufficient pork and beef; d) transmissible; e) the usage of thermally insufficient fish.

PHYLUM NEMATHELMINTHES, CLASS NEMATODA

191. Sequence of ascarids larvas migration in a human being body is: a) intestine → dextral heart → lungs → blood vessels → liver → bronchi → trachea → pharynx → intestines; b) intestine → liver → bronchi → dextral heart → lungs → blood vessels → trachea → pharynx → intestines; c) liver → bronchi → dextral heart → lungs → blood vessels → trachea → pharynx → intestines; d) intestine → blood vessels → liver → dextral heart → lungs → bronchi → trachea → pharynx → intestines; e) intestine → blood vessels → dextral heart → lungs → liver → bronchi → trachea → pharynx → intestines.

192. Diagnostic migratory ascariasis signs are: a) an intestinal obstruction; b) fever and an asthmatic bronchitis; c) flying eosinophilic lungs infiltrates; d) the common bile duct occlusion; e) appendicitis.

193. Surgical ascariasis complications are: a) mechanical jaundice and intestinal obstruction; b) development of an adult species in an eyeball; c) perforation of the intestinal wall; d) pneumonia and bronchitis; e) pancreatitis and appendicitis.

194. The morpho-physiological features of *trichuris* are: a) female length — 5 cm, vesicula on the anterior end of a body; b) 3–5 cm female length, presence of a bulb and an oral capsule with teeth; c) 3–5 cm female length, threadlike anterior end of a body, thickened posterior end; d) cuticular lips available, eats the intestinal contents; e) eats blood.

195. The features of *trichina* development cycle are: a) there are 2 hosts: the basic and mediate; one organism is mediate at first and then is the basic host;

b) one organism is the basic one and then the mediate host; c) larva's development occurs in soil or in water; d) larva's are capable to in pour through the intact skin.

196. The Basic diagnostic signs of trichinosis are: a) brain lesion; b) gastrointestinal disorders; c) temperature rise and eosinophilla; d) eyelids face swelling, pains in muscles; e) liver and spleen enlargement.

197. The morpho-physiological features of filarial are: a) the form of a body is threadlike, lay eggs; b) the form of the body is ribbon-shaped, viviparous; c) the form of the body is threadlike; viviparous; d) the dimensions of the body are 3–10 mm; e) the dimensions of the body are 3–10 cm.

198. The features of filaria development cycles are: a) with the change of the hosts, mediate hosts are mainly representatives of dipterous group; b) larvae are capable to penetrate through the intact skin; c) discharge larvae into soil or water; d) discharge larvae into the tissues of the basic host; e) lay eggs in subcutaneous fatty tissue.

199. Final hosts of filaria are: a) human being man, monkeys; b) cats, dogs; c) herbivorous mammals; d) pigs and wild boars; e) the lowest crustaceans.

200. Intermediate filaria host are: a) man and monkeys; b) mosquito's and gnats; c) cats and dogs; d) crustaceans Cyclopes and daphnia; e) gnats and gadflies.

201. The means of filariasis mans invasion are: a) active penetration of larvae through the skin; b) the ingestion of Cyclopes with microfilaria; c) personal hygiene neglect; d) at contacts with filariasis patients; e) transmissibly.

202. The means of laboratory filariasis diagnostics are based on: a) detection of microfilaria in blood; b) detection of eggs and larvae in excrements; c) detection of microfilaria in skin sections and subcutaneous nodes; d) immunologic methods; e) detection of larvae in cross-striated muscles.

203. The Basic diagnostic features of ankylostomiasis are: a) pains along the large intestine; b) a headache and memory weakening; c) physical and intellectual retardation in children; d) anemia; e) pains in joints.

204. The means of laboratory ankylostomiasis diagnostics are based on: a) detection of eggs or larvae in excrements; b) detection of larvae or adult ankylostomas in blood; c) immunologic methods; d) detection larvae in cross-striated muscles; e) ankylostomae detection in punctated liver and pancreas.

PHYLUM ARTHROPODA, CLASS ARACHNOIDEA

205. Transmissible illnesses are the diseases transferred: a) at contact of a healthy and a sick person; b) at drinking of water from the open resources; c) at the use of the infested meat and a fish; d) blood-sicking transmitting agents; e) airborne.

206. The natural locus of transmissible illness includes: a) the originator and transmitting agents of the disease stimulator; b) resistant organisms to

the originator; c) acquisitive to the originator of organisms; d) man; e) the certain conditions of medium.

207. By their extent the natural locuses are divided into: a) narrowly limited and integrated; b) admixed; c) both diffusive and integrated; d) anthropurgic and admixed; e) synanthropic and diffusive.

208. By their origin the natural locuses are divided into: a) both narrowly limited and interfacing; b) admixed and diffusive; c) diffusive and interfacing; d) anthropurgic and admixed; e) synanthropic and natural.

209. Specific transmitting agents of illnesses originators are the following organisms: a) in the body of which the originator passes a part of its development cycle, obligatory for the parasite; b) in the body of which the originator does not pass a part of its development cycle, obligatory for the parasite; c) carrying originators on body integuments and paws; d) in the body of which the originator does not pass a part of the development cycle, facultative to the parasite; e) in which the originator passes through the gastrointestinal tract without reproduction.

210. Features of ixod ticks are: a) habitation — the open spaces of the forest-steppe region; b) habitation — caves, holes of gnawers, nidi of birds; c) bloodsucking time — from several hours to several days; d) duration of starvation — 10–12 years; e) amount of laid eggs — is 50–200.

211. D. gallinae Tick belongs to the family: a) Ixodae; b) Argasidae; c) Gamasidae; d) Tyroglyphidae; e) Sarcoptidae.

212. Characteristics of Tyroglyphidae ticks are: a) yellowish-brown colour, the form of a body is ovoid, fine; b) yellowish-brown colour, the absence of organs of sight; c) light-yellow colour, the form of a body is long oval, fine; d) light yellow colour, the form of a body is long oval, the absence of organs of sight; e) light yellow colour, the form of a body is ovoid, absence of organs of sight.

213. The Flour tick in a human organism affects: a) urinogenital and respiratory tracts; b) the liver and the pancreas; c) the blood and the lymph; d) the gastrointestinal tract; e) respiratory tract and the skin.

214. The medical T. farinae aspect is: a) a transmitting agent of tularemia originators and the anthrax; b) a transmitting agent of Russian tick-borne and Scottish encephalitis originators; c) causes scabies and bronchospasms; d) causes a «grain itch» and catarrhal signs of gastrointestinal tract; e) causes meningoencephalitis.

215. The medical S. scabiei aspect is: a) a transmitting agent of Russian tick-borne and Scottish encephalitis originators; b) a transmitting agent of tularemia and brucellosis originators; c) the originator of catarrhal symptoms of gastrointestinal tract; d) causes bronchospasms; e) the originator of scabies.

216. The ways and methods of mans scabies infestation are: a) transmissible and transplantsible; b) at contact with sick people and animals;

c) the use of insufficiently thermally prepared fish; d) through bed-clothes and household goods; e) drinking water from the open sources.

217. Preventive measures scabies are: a) revealing and treatment of patients, sanitary inspection of hostels and public baths; b) elimination of transmitting agents; c) maintenance of a body, linen and dwellings cleanliness; d) careful washing of vegetables and fruit; e) sufficient thermal processing of meat products.

PHYLUM ARTHROPODA, CLASS INSECTA, ORDER DIPTERA

218. Types of the insects oral cavity are: a) gnawing and stinging; b) sucking, licking and piercing-gnawing; c) gnawing, licking, piercing-sucking; d) sucking-gnawing and sucking; e) drinking up, sucking, stinging.

219. Morphological features of cockroaches: a) the dimensions of a body are up to 3 cm, compressed to the dorsoventral direction; b) the dimensions of a body are up to 3 cm, laterally clinched; c) the dimension of the body are up to 8 cm, the oral cavity is of a gnawing type; d) the dimensions of a body are up to 3 cm, the oral cavity is of a gnawing type; e) the body is flattened in dorsoventral direction, the oral cavity is of a piercing-sucking type.

220. Medical aspect of cockroaches: a) mechanical transmitting agents of eggs of helminths, cyst protists and originators of intestinal infections; b) specific transmitting agents of tularemia and a tuberculosis originators; c) specific transmitting agents of malaria and filariasis originators; d) gnaw infant's epidermis in nasolabial triangle and cause infection; e) originators of the cartarral symptoms in the gastrointestinal tract.

221. Morphological features of a bed bug: a) the body is laterally flattened, its dimensions are up to 8 cm; b) the body is flattened in dorsoventral direction, its dimensions are up to 8 mm; c) the body is flattened to a dorsoventral direction, its dimensions are up to 8 cm; d) dark brownish-red colour, there are scent glands; e) dark brownish-red colour, the scent glands are absent.

222. Morphological features of kiss bug: a) the dimensions of a body are up to 3,5 cm; b) the dimensions of a body are up to 3,5 mm; c) the body is flattened to a dorsoventral direction, there are wings; d) the body is laterally flattened, there are wings; e) dark brownish-red colour, the wings are absent.

223. Morphological features of Pediculus type lice are: a) the dimensions of a body are of 1–4 cm, the absence of wings; b) the dimensions of a body are of 1–4 mm, the presence of one pair of wings; c) the oral cavity is of a gnawing type; d) the dimensions of a body are of 1–4 mm, the absence of wings; e) the oral cavity is of a pricking-sucking.

224. Medical aspect of a bed bug: a) a mechanical transmitting agent of helminths eggs and cysts protists; b) a specific transmitting agent of the plague and tuberculosis originators; c) punctures are painful and causes dermatitis;

d) a mechanical transmitting agent of the tularemia originator; e) larva causes myiasis.

225. Morphological features of fleas are: a) the body is flattened to a dorsoventral direction; b) the body is laterally flattened; c) the oral cavity is of a pricking-sucking type and absence of wings; d) presence of one pair of wings and «salutatory» extremities; e) the oral cavity is of a gnawing type.

226. The medical aspect of fleas is: a) mechanical transmitting agents of tuberculosis and dysentery originators; b) specific transmitting agents of cyst protists and eggs of helminths; c) specific transmitting agents of the plague originator; d) punctures are painful and causes dermatitis; e) mechanical transmitting agents of tularemia originators.

227. Features of Pediculus family louse life cycle are: a) lay eggs in dry dust and on food products; b) eggs stick to hair; c) the development is direct; d) the development is with semimetamorphosis; e) the duration of life cycle is 2–3 months.

228. The medical aspect of Pediculus family louse is: a) mechanical transmitting agents of helminths eggs and cyst protists; b) specific transmitting agents of the louse-born recurrent typhus originator; c) specific transmitting agents of the louse-born typhus originator; d) pediculosis originators, punctures produce itching; e) originators of phthiriosis, punctures produce itching.

229. Morphological features of Phthirus type lice are: a) a body is short and wide, the dimension is up to 10 mm; b) a body is short and wide, the dimension is up to 1,5 mm; c) a body is extended, the dimension is up to 5 mm; d) the oral cavity is of pricking-sucking type; e) the oral cavity is of gnawing type.

230. Medical aspect of P. pubis louse is: a) mechanical transmitting agents of the recurrent and classical typhus originators; b) specific transmitting agents of cyst protists and of helminths eggs; c) originators of phthiriosis; d) specific transmitting agents of malaria originators; e) damages the skin with rare rigid hair, punctures produce itching.

231. Morphological features of a room fly: a) the dimensions of a body are about 7 cm, the oral cavity is licking-sucking; b) the dimensions of a body are about 7 mm, the oral cavity is licking-sucking; c) the body is covered with hair, one pair of wings; d) the oral cavity is licking-sucking, there's a pair of great facet eyes; e) the oral cavity is gnawing, two pairs of wings.

232. The medical aspect of a room fly is: a) a specific transmitting agent of bacteria, cyst protists and helminths eggs; b) a mechanical transmitting agent of bacteria, cyst protists and helminths eggs; c) a specific transmitting agent of the plague and Japanese encephalitis originators; d) larvae produce myiasis; e) a specific transmitting agent of African trypanosomiasis originators.

233. The medical aspect of a stable fly is: a) a mechanical transmitting agent of cyst protists and helminths eggs; b) mechanical transmitting agent of

sepsis and the anthrax originators; c) a specific transmitting agent of sepsis and the anthrax originators; d) larvae produce myiasis; e) punctures are painful.

234. The medical aspect of midges is: a) mechanical transmitting agents of cyst protists and helminths eggs; b) mechanical transmitting agents of the tuberculosis originator; c) mechanical transmitting agents of the tularemia originator, punctures unhealthy; d) mechanical transmitting agents of sepsis and anthrax originators; e) specific transmitting agents of the onchocercosis originator.

235. The medical aspect of black gnats is: a) mechanical transmitting agents of cyst protists and helminths eggs; b) mechanical transmitting agents of the tuberculosis originator; c) mechanical transmitting agents of tularemia originators, punctures are painful; d) mechanical transmitting agents of sepsis and anthrax originators; e) specific transmitting agents of filariasis originators.

236. The Family of horse fly is called: a) Muscidae; b) Tabanidae; c) Simuliidae; d) Culicidae; e) Phlebotomidae.

237. Morphological features of preimago stages of Anopheles mosquitos are: a) eggs have no air chambers, larvae have a siphon; b) eggs have air chambers, larvae have a siphon; c) larvae have no siphon, and pupas have a conical siphon; d) eggs have air chambers, pupas have a cylindrical siphon; e) eggs have air chambers, pupas have a conical siphon.

238. Morphological features of adult stages of Anopheles mosquitos are: a) short moustaches and mandibular feelers of female are very downy, feelers are equal to proboscis by length; b) short moustaches and mandibular feelers of a femail are poorly downy, feelers are equal to proboscis by length; c) mandibular feelers of males are very downy and by length are shorter than proboscis; d) mandibular feelers of males are very downy and at the end have clavate thickenings; e) mandibular feelers of males are very downy and at the end have no clavate thickenings.

239. The medical aspect of Anopheles sort mosquitos is: a) mechanical transmitting agents of helminths eggs and cyst protists; b) specific transmitting agents of tularemia and the plague originators; c) specific transmitting agents of malaria originators; d) specific transmitting agents of the onchocercosis originator; e) punctures are painful.

240. The medical aspect of Aedes sort mosquitos is: a) mechanical transmitting agents of tularemia and Japanese encephalitis originators; b) specific transmitting agents of cyst protists and helminths eggs; c) specific transmitting agents of the plague and tuberculosis originators; d) specific transmitting agents of malaria originators; e) specific transmitting agents of bancroftian filariasis originators.

241. The medical aspect of Culex sort mosquitos is: a) mechanical transmitting agents of tularemia and Japanese encephalitis originators; b) specific transmitting agents of cyst protists and helminths eggs; c) specific transmit-

ting agents of malaria originators; d) specific transmitting agents of bancroftian filariasis originators; e) punctures are painless.

242. The mosquitoes Family refers to: a) Muscidae; b) Tabanidae; c) Simuliidae; d) Culicidae; e) Phlebotomidae.

EVOLUTION OF ORGAN SYSTEMS

243. Directions of evolution of cord animal integuments: 1) differentiation to epidermis and derma; 2) from a single-layered epidermis to multi-layered; 3) division of derma into papillary and reticular layers; 4) from multilayered epidermis to single-layered; 5) development of derivatives of the skin; 6) from multicellular glands to monocellular. a) 1, 4, 5, 6; b) 1, 2, 3, 6; c) 1, 2, 3, 5; d) 2, 3, 4, 6; e) 2, 3, 5, 6.

244. Directions of evolution of cord animals axial skeleton: 1) changing of the chord by the spine; 2) from 2 spinal parts up to five ones; 3) increase in the number of vertebrae in the departments; 4) from a multiradial fin to a five-fingered extremity; 5) increase of mobility of bond junction with their girdles; 6) decrease in number of bones in free extremity and their enlargement a) 1, 4, 5; b) 1, 3, 5; c) 1, 2, 3; d) 1, 2, 4; e) 1, 3, 4.

245. Defects of mans skeletal development depending on ontophylogenetic conditions are the following: a) macrocephaly and the development of a tail part of the spine; b) defect of the backbone canal, due to spondylosis and additional wrist bones; c) a crevice of the hard palate and the development of tail part of the spine; d) microcephalia and the development of a tail part of the spine; e) microcephaly and multipapillary condition.

246. Directions of evolution of chord animals alimentary system are the following: 1) differentiation of the alimentary tract to departments; 2) development of alimentary glands; 3) appearance of dens and their differentiation; 4) appearance of a posterior part department of the intestines; 5) appearance of the oral cavity; 6) increase of sucking surface due to intestinal lengthening and appearance of villi. a) 1, 2, 4, 5; b) 1, 2, 5, 6; c) 1, 2, 3, 6; d) 1, 2, 3, 5; e) 1, 3, 4, 6.

247. Directions of evolution of chord animals branchial respiration are the following: 1) from the branchial lancet apertures to gills of fish; 2) from the branchial device of fish to branchial lancets apertures; 3) decrease in number of gills; 4) increase in number of gills; 5) increase of the respiratory surface due to the formation of branchial petals; 6) formation of branchial capillaries. a) 1, 2, 4, 5; b) 1, 3, 4, 6; c) 1, 3, 4, 5; d) 1, 2, 3, 5; e) 1, 3, 5, 6.

248. Directions of evolution of chordate animal lung respiration are the following: 1) from the lungs of an alveolar constitution to the honeycomb lungs; 2) a differentiation of the respiratory tract; 3) appearance of the vocal device; 4) from the saccular lungs to the lungs of an alveolar con-

stitution; 5) increase of the respiratory surface of the lungs; 6) decrease of the respiratory surface of the lungs. a) 2, 3, 4, 5; b) 2, 3, 4, 6; c) 1, 3, 4, 5; d) 1, 2, 3, 5; e) 1, 3, 5, 6.

249. Directions of evolution of chordate animals blood system are the followings: 1) from 2 chamber heart to 3 chamber one; 2) from 3 chamber heart to 4 chamber one; 3) decrease in number of arterial branchial arches; 4) increase in number of arterial branchial arches; 5) from 3 chamber heart to 2 chamber one; 6) appearance of pulmonary circulation and complete division of the arterial and a venous blood. a) 1, 2, 4, 5; b) 1, 2, 4, 6; c) 2, 3, 4, 6; d) 1, 2, 3, 6; e) 1, 2, 5, 6.

250. Directions of evolution of chordate animals urinary system are the following: 1) from the primary nephros to the metanephros; 2) from the primary nephros to the prenephros; 3) from a metanephros to the prenephros; 4) from the metanephros to the primary; 5) from the pronephric canal to the mesonephrogenic canal 6) from the mesonephrogenic canal to the metanephrogenetic one. a) 1, 3, 6; b) 1, 5, 6; c) 1, 4, 5; d) 1, 4, 5; e) 2, 5, 6.

251. Defects of mans urinary systems caused by onto-phylogenetic conditions are the following a) conservation of pronephric duct and presence of one nephros; b) presence of one nephros and conservation of mesonephric canal; c) presence of three nephroses and conservation of mesonephric canal; d) presence of primordial kidneys and conservation of mesonephric canal; e) conservation of mesonephric canal and doubling ureters.

VENOMOUS ANIMALS

252. Actively-venomous animals: a) jellyfish and snails molluscums; b) a cobra and a tarantula; c) a python and a tarantula; d) a tarantula and a fish-fugue; e) a fish-fugue and snails molluscums.

253. Passively-venomous animals: a) jellyfishes and a tarantula; b) a cobra and a boa; c) a python and a fish-fugue; d) a tarantula and snails molluscums; e) a fish-fugue and snails molluscums.

254. The armed active-venomous animals: a) snakes and slopes; b) a fish-fugue and wasps; c) bees and amphibious; d) snails molluscums and bees; e) snakes and amphibious.

255. Unaided active-venomous animals: a) both snakes and amphibious; b) a fish-fugue and slopes; c) bees and slopes; d) snails molluscums and amphibious; e) slopes and snails molluscums.

256. Toads and frogs are animals: a) primarily-venomous unaided; b) secondary-venomous unaided; c) active-venomous unaided; d) passively-venomous unaided; e) secondary-venomous armed.

257. Bees and wasps are animals: a) primarily-venomous armed; b) again-venomous armed; c) is actively-venomous armed; d) passively-venomous armed; e) passively-venomous unaided.

258. The Factors determining zootoxins venenation are the following: a) the structure and the quantity of the venom; b) a place of a lesion; c) sex of the affected person; d) a habitus of the affected person; e) time of a day.

259. In case of scorpions venoming: a) a sharp pain, a hyperemia and a hypostasis of the affected place; b) hyperemia and hypostasis of the injured place, sense of fear; c) neither hyperemias nor hypostasis of the injured place, nausea and vomiting; d) a sharp pain, a feeling of fear; e) sense of fear, nausea and vomiting are observed.

260. In case of tarantula venoming: a) a sharp pain and drowsiness; b) a hyperemia and a hypostasis of the affected place, a necrosis of the skin; c) neither hyperemias nor hypostasis of the affected place; d) hyperemia and hypostasis of the affected place, drowsiness; e) drowsiness, necrosis of the skin are observed.

261. In case of bees and wasps venoming: a) sharp pain, sense of fear; b) hyperemia and hypostasis of the affected place, allergic reactions; c) neither hyperemias nor hypostasis of the injured place; d) allergic responses, a sense of fear; e) a sharp pain are observed.

262. In case of cobra venoming: a) a sharp pain, an inflammation of lymphatic vessels; b) an inflammation of lymphatic vessels, a necrosis of tissues; c) a sharp pain, a necrosis of tissues; d) exaltation, and then CNS oppression, a necrosis of tissues; e) exaltation, and then CNS oppression, impairment of respiration are observed.

263. In case of Viperidae snakes venoming: a) a sharp pain and impairment of blood clotting; b) extremities numbness and hemorrhagic hypostases; c) hemorrhagic hypostases; d) extremities numbness and impairment of respiration; e) blood clot impairment and impairment of respiration are observed.

264. First aid in a venenation with hymenopterous venom is the following: a) to suck away venom, to treat the place of stinging with disinfectants; b) to remove a sting, to treat the place of stinging with disinfectants; c) to treat the place of stinging with disinfectants, to apply heat to a place of stinging; d) to apply a warm hard bandage to the place of stinging; e) to abandon a sting, to treat the place of stinging with disinfectants.

265. First aid in a venenation with a snakes venom is the following: a) to suck away venom and to treat the place of a puncture with disinfectants; b) to cauterize the place of puncture and to put a victim in a shade; c) to cauterize and to treat the place of a puncture with disinfectants; d) to transport a victim in lying position; e) to apply a hard bandage to a place of a puncture and to transport a victim in any position.

ANSWERS TO THE OPEN TESTS

HUMAN IN THE SYSTEM OF NATURE

1. Autoregulation. 2. Holocoenotic. 3. 32. 4. Hominid. 5. Placental.

BIOLOGY OF THE CELL. THE FLOW OF SUBSTANCE AND ENERGY IN THE CELL

6. Compartmentalization. 7. Glycocalyx. 8. 6–8.
9. Golgi's complex. 10. Glyoxysomes. 11. Golgi's complex.
12. Autophagy. 13. Porin. 14. 3. 15. 40 %.

TEMPORAL ORGANIZATION OF THE CELL

16. Lamins. 17. Kinetochore. 18. Nucleolar organizer.
19. $2n$ $2chr$ $4c$. 20. $1n_{biv}$ $4chr$ $4c$. 21. $1n_{biv}$ $4chr$ $4c$.
22. $1n_{biv}$ $4chr$ $4c$. 23. Chiasmata. 24. Bivalent chromosome.
25. $1n$ $2chr$ $2c$.

BASES OF CYTOGENETICS

26. Paris classification. 27. Denver classification. 28. Individuality.
29. C. 30. G. 31. 13–15. 32. Satellite.
33. C. 34. 1q31. 35. 6p41.

ORGANIZATION OF THE HEREDITARY MATERIAL

36. Transformation. 37. Transduction. 38. Fraenkel–Conrat.
39. Replication. 40. $3'$ – $5'$. 41. Unidirectionality.
42. Recognition. 43. AUG. 44. Elongation.
45. Inhibitor. 46. Nucleosome. 47. 5–7.
48. Chromatid. 49. 10 000. 50. Introns.
51. Repressors. 52. Repressors. 53. Inductor.
54. Splicing. 55. Mitochondria.

GENETIC ENGINEERING

56. Restrictase. 57. Restrictase. 58. Fermentative synthesis.
59. Liposomes. 60. Phasmids. 61. Cosmids. 62. 33–39.
63. SV40. 64. Sticky ends. 65. Obtuse ends.

INHERITANCE REGULARITIES. INTERACTION OF GENES

66. Alternative. 67. 100. 68. Recessive epistasis.
69. Complementary. 70. 1:1:1:1. 71. Cumulative. 72. Multiple.

LINKAGE OF GENES

73. Linkage of genes 74. Complete. 75. Incomplete.
76. Incomplete. 77. Crossingover. 78. Crossingover.
79. 50. 80. Recombinant. 81. 22.

VARIATION

82. Exonuclease. 83. Transition. 84. Deletions.
85. Functional. 86. Genomic. 87. Monosomy.
88. Haploidy. 89. Fanconi's anemia.

BIOLOGY AND GENETICS OF SEX

90. Trisomy. 91. Turner's syndrome. 92. Klinefelter's syndrome.
93. Transvestism. 94. Miosis. 95. Holandric. 96. Transsexualism.

BASES OF HUMAN GENETICS

97. Proband. 98. 18,75 %. 99. 20 %.
100. Hybridization. 101. X-lined dominant. 102. Twin.
103. Cytogenetic. 104. Loading. 105. 8–12.
106. Mathematical modeling. 107. Reduces. 108. Ultrasonography.
109. Direct invasive. 110. Acrichine-yperite. 111. 57°.
112. Isolate. 113. Heterozygous.

HUMAN GENETIC AND CHROMOSOMAL DISEASES

114. Ceruloplasmine. 115. Valine. 116. Lesch-Nyhan's syndrome.
117. Albinism. 118. Wilson's disease. 119. Hyperlipoproteinemia.
120. Chromosomal. 121. Edwards' syndrome.

MEDICAL-GENETIC CONSULTATION

122. Pathogenetic. 123. Pathogenetic. 124. Symptomatic.
125. Symptomatic. 126. Etiological.

REPRODUCTION OF ORGANISMS

- | | | |
|----------------------------------|--------------------|----------------------|
| 127. Conjugation. | 128. Syncaryogamy. | 129. Partenogenesis. |
| 130. Sharply telolecithal. | 131. Isolecithal. | 132. Mitosis. |
| 133. Miosis. | 134. Polyembryony. | |
| 135. Fertilizin (gynogamone II). | | 136. 24–48 h. |

BASES OF ONTOGENESIS (EMBRYONIC DEVELOPMENT)

- | | | |
|---------------------------|-------------------|------------------------------|
| 137. Splitting. | 138. Pre-fetal. | 139. Immigration. |
| 140. Deuterostomes. | 141. Provisional. | 142. Chemical heterogeneity. |
| 143. Embryonic induction. | 144. Gradient. | |

BASES OF ONTOGENESIS (POSTEMBRYONIC DEVELOPMENT)

- | | | |
|--------------------|-------------------------------|--------------------|
| 145. Lymphoid. | 146. Somatotropin. | 147. Acceleration. |
| 148. Constitution. | 149. Ectomorphic (asthenics). | 150. Geriatrics. |
| 151. Valeology. | 152. Clinical. | 153. Euthanasia. |

INTRODUCTION TO PARASITOLOGY

- | | | |
|-------------------------|-------------------|------------------------------|
| 154. False parasites. | 155. Obligatory. | 156. Potential. |
| 157. Permissive. | 158. Alimentary. | 159. Air-drop (respiratory). |
| 160. Contact-household. | 161. Transfusive. | |

PHYLUM SARCOMASTIGOPHORA, CLASSES SARCODINA, ZOOMASTIGOTA

- | | | |
|---------------------------|-------------------------------------|--------------------|
| 162. Trophozoit. | 163. Dysentery amoeba, balantidium. | |
| 164. Meningoencephalitis. | 165. Axostyle. | 166. Tsetse fly. |
| 167. Cruzei. | 168. Chagoma. | 169. Promastigota. |
| | | 170. 5. |

PHYLUM INFUSORIA, CLASS CILIATA

PHYLUM APICOMPLEXA, CLASS SPOROZOA

- | | | |
|----------------------------------|-----------------------------|-----------------|
| 171. falciparum. | 172. malaria. | 173. Sporozoit. |
| 174. Micro- and macrogametocyte. | | 175. malaria. |
| 176. falciparum. | 177. Conoid. | 178. Cats. |
| 179. Sporozoit, trophozoit. | 180. Sporozoit, trophozoit. | |

PHYLUM PLATHELMINTHES, CLASS TREMATODA

- | | | |
|-----------------------|-----------------------|---------------------------|
| 181. Invasive stages. | 182. Cat liver fluke. | 183. Cercaria. |
| 184. Pulmonary. | 185. Metacercaria. | 186. Gynecofornous canal. |
| 187. Sporocyst II. | 188. Cercaria. | |

PHYLUM PLATHELMINTHES, CLASS CESTOIDEA

189. Dwarf tenia. 190. 2. 191. 17–35.
192. Cysticerc. 193. 3. 194. 7–12.
195. Cysticercoid. 196. 200. 197. Intermediate.
198. Coracidium

PHYLUM NEMATHELMINTHES, CLASS NEMATODA

199. Hypoderm. 200. One. 201. Enterobius vermicularis.
202. One year. 203. Larva migrans. 204. Whipworm.
205. One month. 206. Biopsy. 207. Duodenal assasin worm.
208. Rabtid. 209. Dwarf treadworm. 210. Onchocerca.
211. Macroscopic methods. 212. Kalantaryan.
213. Fulleborn. 214. Immunological.

PHYLUM ARTHROPODA, CLASS ARACHNOIDEA

215. Ixodidae. 216. Dermacentor. 217. Transovarial.
218. Tularemia and Scotch encephalitic.
219. Russian spring-summer encephalitis. 220. Scotch encephalitic.
221. Spring-summer encephalitis. 222. Tick enteric fever.
223. Hemorrhagic fevers. 224. Argasidae. 225. Flour.

PHYLUM ARTHROPODA, CLASS INSECTA

226. Plague. 227. Rodents. 228. «Plague block».
229. Sarcopsillemis. 230. Pediculosis. 231. Phthiriosis.
232. Nit. 233. Louse-born relapsing and a louse-born enteric fever.
234. Obermeier's Spirochaeta. 235. Mechanical.
236. Anthrax, sepsis. 237. African trypanosomosis.
238. Myiasis. 239. Underwater stones and plants.
240. Onchocercosis. 241. Leischmaniosis and pappatachi fever.
242. Mosquitos. 243. Gonotrophic cycle. 244. Anopheles.

EVOLUTION OF ORGAN SYSTEMS

245. Archalaxises. 246. Parallelisms.
247. Amphibians. 248. Sauropsidic (striatal).
249. Trabeculae. 250. Hyostyle type.
251. Amphibians. 252. Venous sinus.
253. Cutaneous-pulmonary artery. 254. Pulmonary arteries.
255. Carotid arteries. 256. Nephridium.
257. Cyclostomes. 258. 100.

VENOMOUS ANIMALS

259. Armed. 260. Hemolyzins. 261. Striking cells.
262. Neurotoxin. 263. Neurotoxin 264. Hemorrhagens.
265. Neurotoxins. 266. 50. 267. Armed.

ANSWERS TO THE CLOSE TESTS

HUMAN IN THE SYSTEM OF NATURE

1. a, e. 2. e. 3. a, c, e. 4. a, c. 5. b, e. 6. b, c. 7. a, d. 8. a, b, e.

BIOLOGY OF THE CELL. THE FLOW OF SUBSTANCE AND ENERGY IN THE CELL

9. a, c, e. 10. b, e. 11. b, c. 12. a, e.
13. a, d. 14. a, c, d. 15. a, b, d. 16. a, e. 17. d.

TEMPORAL ORGANIZATION OF THE CELL

18. a, c. 19. c, e. 20. d. 21. b, d. 22. c.
23. a, c. 24. a, d, e. 25. c. 26. d. 27. c, e.

BASES OF CYTOGENETICS

28. b, d. 29. b, e. 30. a, d. 31. c. 32. c, d, e. 33. a, d.
34. a. 35. b. 36. d. 37. b, c. 38. b. 39. e.

ORGANIZATION OF THE HEREDITARY MATERIAL

40. b. 41. a. 42. a, c, e. 43. b. 44. a, b. 45. b.
46. c. 47. b. 48. c, e. 49. b. 50. c, e. 51. b, c, d.
52. a. 53. a, c. 54. c. 55. d. 56. b, d. 57. a, c.

GENETIC ENGINEERING

58. a, c. 59. a, d, e. 60. a, c, e. 61. b, c, e.
62. a, c, e. 63. b, c, e. 64. d, e. 65. b.

INHERITANCE REGULARITIES. INTERACTION OF GENES

66. a, c, d. 67. b, e. 68. d. 69. d. 70. a, d. 71. b. 72. e.

LINKAGE OF GENES

73. a. 74. d, e. 75. a, c. 76. a, c. 77. b. 78. e. 79. e.

VARIATION

80. a, c. 81. a, e. 82. a, d. 83. d. 84. b.
85. e. 86. d, e. 87. e. 88. a, c

BIOLOGY AND GENETICS OF SEX

89. d. 90. d. 91. b. 92. c. 93. b, c.
94. e. 95. c. 96. b. 97. a. 98. d.

BASES OF HUMAN GENETICS

99. c. 100. a, e. 101. b. 102. b. 103. b.
104. b. 105. a, c. 106. a, c, d. 107. a. 108. b.
109. e. 110. e. 111. d. 112. b. 113. c. 114. b, d.

HUMAN GENETIC AND CHROMOSOMAL DISEASES

115. b. 116. b, e. 117. a, b, e. 118. a, c, e. 119. c.
120. e. 121. b. 122. c. 123. b, e.

MEDICAL-GENETIC CONSULTATION

124. a, c, d. 125. d, e. 126. a. 127. c.
128. b, d. 129. b, d, e. 130. e. 131. b, d.

REPRODUCTION OF ORGANISMS

132. b, d. 133. b, c. 134. a, c. 135. d, e.
136. b, c. 137. a, d. 138. b. 139. c.

BASES OF ONTOGENESIS (EMBRYONIC DEVELOPMENT)

140. c, d. 141. e. 142. b, e. 143. b, c.
144. a, d. 145. b, c. 146. a, d. 147. a, c.

BASES OF ONTOGENESIS (POSTEMBRYONIC DEVELOPMENT)

148. b, c, d. 149. a. 150. c, e. 151. a.
152. b, d, e. 153. c. 154. c, e. 155. a.

INTRODUCTION TO PARASITOLOGY

156. d. 157. a, c. 158. c, d. 159. a, d, e.
160. d. 161. b, d. 162. a, d, e.

PHYLUM SARCOMASTIGOPHORA, CLASSES SARCODINA, ZOOMASTIGOTA

- | | | | |
|------------|---------------|---------------|---------------|
| 163. d. | 164. b, c, d. | 165. a, c, d. | 166. a, e. |
| 167. b, e. | 168. a, d, e. | 169. b, d. | 170. a, c, e. |

**PHYLUM INFUSORIA, CLASS CILIATA
PHYLUM APICOMPLEXA, CLASS SPOROZOA**

- | | | | | |
|---------|---------|---------|---------|---------|
| 171. c. | 172. d. | 173. b. | 174. e. | 175. c. |
|---------|---------|---------|---------|---------|

PHYLUM PLATHELMINTHES, CLASS TREMATODA

- | | | | |
|---------|------------|------------|------------|
| 176. c. | 177. d. | 178. a, e. | 179. b, c. |
| 180. b. | 181. b, e. | 182. b, c. | 183. a, d. |

PHYLUM PLATHELMINTHES, CLASS CESTOIDEA

- | | | | |
|---------|---------|------------|---------------|
| 184. b. | 185. d. | 186. a, e. | 187. b, d, e. |
| 188. c. | 189. a. | 190. b. | |

PHYLUM NEMATHELMINTHES, CLASS NEMATODA

- | | | | | |
|---------------|------------|---------------|------------|------------|
| 191. d. | 192. b, c. | 193. a, c, e. | 194. c, e. | 195. c. |
| 196. b, c, d. | 197. c, e. | 198. a, d. | 199. a, b. | 200. b, e. |
| 201. e. | 202. a, d. | 203. b, c, d. | 204. a. | |

PHYLUM ARTHROPODA, CLASS ARACHNOIDEA

- | | | | | |
|------------|---------------|------------|------------|---------|
| 205. d. | 206. a, c, e. | 207. a, c. | 208. d, e. | 209. a. |
| 210. a, c. | 211. c. | 212. e. | 213. d, e. | 214. d. |
| 215. e. | 216. b, d. | 217. a, c. | | |

PHYLUM ARTHROPODA, CLASS INSECTA, ORDER DIPTERA

- | | | | | |
|---------------|------------|------------|---------------|------------|
| 218. c. | 219. a, d. | 220. a, d. | 221. b, d. | 222. a, c. |
| 223. d, e. | 224. c. | 225. b, c. | 226. c, d, e. | 227. b, d. |
| 228. b, c, d. | 229. b, d. | 230. c, e. | 231. b, c. | 232. b. |
| 233. b, e. | 234. c, e. | 235. c, e. | 236. b. | 237. c, e. |
| 238. b, d. | 239. c, e. | 240. a, e. | 241. a, d. | 242. e. |

EVOLUTION OF ORGAN SYSTEMS

- | | | | | |
|---------|---------|---------|---------|---------|
| 243. c. | 244. c. | 245. b. | 246. c. | |
| 247. e. | 248. a. | 249. d. | 250. b. | 251. d. |

VENOMOUS ANIMALS

252. b.	253. e.	254. a.	255. d.	256. a, d.
257. a, c.	258. a, b.	259. a.	260. b.	261. b, e.
262. a, e.	263. a, c.	264. b.	265. a, d.	

Репозиторий БГМУ

LITERATURE

1. *Bekish, O.-Y. L. Medical biology : textbook for student of higher educational establishments / O.-Y. L. Bekish. Vitebsk : VSMU Press, 2003. 346 p.*
2. *Medical biology and genetics for international students 1st year : lecture course / I. V. Rachkovskaya [et al.]. Minsk : BSMU, 2014. 205 p.*
3. *Медицинская биология и общая генетика : терминологический словарь для иностранных студентов / В. Э. Бутвиловский [и др.]. Минск : БГМУ, 2007. 55 с.*
4. *Медицинская биология и общая генетика : тесты / В.Э. Бутвиловский [и др.]. Минск : БГМУ, 2006. 228 с.*
5. *Медицинская биология и общая генетика : сборник задач / В.Э. Бутвиловский [и др.]. 2-е изд. Минск : БГМУ, 2010. 264 с.*
6. *Медицинская биология и общая генетика : учеб. / Р.Г. Заяц [и др.]. 2-е изд., испр.: Минск : Выш. школа, 2012. 496 с.*
7. *Частная паразитология : учеб.-метод. пособие. / В.Э. Бутвиловский [и др.]. Минск : БГМУ, 2007. 107 с.*

CONTENTS

Human in the system of nature.....	3
Magnifying devices. Methods of studying cells	6
Biology of the cell. The flow of substance and energy in the cell.....	9
Temporal organization of the cell	14
Bases of cytogenetics	19
Organization of hereditary material	21
Genetic engineering.....	31
Inheritance regularities. Interaction of genes	35
Linkage of genes.....	40
Variation	43
Biology and genetics of sex.....	48
Bases of human genetics	52
Human genetic and chromosomal diseases.....	60
Medical-genetic consultation	63
Reproduction of organisms	66
Bases of ontogenesis (embryonic development).....	71
Bases of ontogenesis (postembryonic development).....	76
Introduction to parasitology	81
Phylum Sarcomastigophora, classes Sarcodina, Zoomastigota	86
Phylum Infusoria, class Ciliata, phylum Apicomplexa, class Sporozoa.....	98
Phylum Plathelminthes, class Trematoda.....	105
Phylum Plathelminthes, class Cestoidea	112
Phylum Nematelminthes, class Nematoda	120
Phylum Arthropoda, class Arachnoidea.....	135
Phylum Arthropoda, class Insecta, order Diptera	139
Evolution of organ systems	152
Venomous animals	165
Open tests	169
Close tests.....	182
Answers to the open tests	209
Answers to the close tests.....	214
Literature	218

Учебное издание

Бутвиловский Валерий Эдуардович
Давыдов Владимир Витольдович
Рачковская Ирина Владимировна и др.

**МЕДИЦИНСКАЯ БИОЛОГИЯ
И ОБЩАЯ ГЕНЕТИКА
ДЛЯ ИНОСТРАННЫХ СТУДЕНТОВ
1-го ГОДА ОБУЧЕНИЯ**

**MEDICAL BIOLOGY AND GENETICS
FOR INTERNATIONAL STUDENTS 1ST YEAR**

Учебно-методическое пособие

На английском языке

5-е издание, исправленное

Ответственный за выпуск В. Э. Бутвиловский
Переводчик Т. Ф. Данилова
Компьютерный набор В. В. Давыдова
Компьютерная верстка Н. М. Федорцова

Подписано в печать 16.04.14. Формат 60×84/16. Бумага писчая «Снегурочка».

Ризография. Гарнитура «Times».

Усл. печ. л. 12,79. Уч.-изд. л. 12,92. Тираж 60 экз. Заказ 335.

Издатель и полиграфическое исполнение: учреждение образования
«Белорусский государственный медицинский университет».

Свидетельство о государственной регистрации издателя, изготовителя,
распространителя печатных изданий № 1/187 от 18.02.2014.

Ул. Ленинградская, 6, 220006, Минск.