

ESSENTIAL CHEMISTRY FOR FOREIGN STUDENTS

Minsk BSMU 2018

МИНИСТЕРСТВО ЗДРАВООХРАНЕНИЯ РЕСПУБЛИКИ БЕЛАРУСЬ
БЕЛОРУССКИЙ ГОСУДАРСТВЕННЫЙ МЕДИЦИНСКИЙ УНИВЕРСИТЕТ
КАФЕДРА ОБЩЕЙ ХИМИИ

ОСНОВЫ ХИМИИ ДЛЯ ИНОСТРАННЫХ СТУДЕНТОВ

ESSENTIAL CHEMISTRY FOR FOREIGN STUDENTS

Учебно-методическое пособие

5-е издание



Минск БГМУ 2018

УДК 54(075.8)-054.6
ББК 24я73
О-75

Рекомендовано Научно-методическим советом университета в качестве учебно-методического пособия 20.06.2018 г., протокол № 10

Авторы: доц. С. В. Ткачѐв, доц. Т. В. Латушко, ст. преп. С. Р. Казюлевич, проф. Е. В. Барковский

Рецензенты: доц. О. Н. Ринейская; проф. В. К. Кухта

Основы химии для иностранных студентов = Essential chemistry for foreign O-75 students : учебно-методическое пособие / С. В. Ткачѐв [и др.]. – 5-е изд. – Минск : БГМУ, 2018. – 168 с.

ISBN 978-985-21-0081-6.

Содержит теоретический материал по основным разделам общей химии и состоит из 12 глав. Содержание издания знакомит студентов с основами строения вещества, химической термодинамикой и кинетикой, с коллигативными свойствами растворов, теоретической электрохимией, дисперсными системами и поверхностными явлениями. 1-е издание вышло в 2011 году.

Предназначено для студентов 1-го курса медицинского факультета иностранных учащихся с обучением на английском языке.

УДК 54(075.8)-054.6
ББК24я73

ISBN 978-985-21-0081-6

© ОУ «Белорусский государственный медицинский университет», 2018

PREFACE

Our goal in writing of this guide to present the material that is essential for a one-year foreign student. This guide is based on the lectures on General, Biophysical and Colloidal chemistry which are being delivered in the Byelorussian state medical university.

We have made an effort to write only those concepts which are either useful in the General, Organic and Biological chemistry or which help to give a picture of what presently concerns the future doctor.

As you know chemistry is based on the idea that matter is composed of particles such as electrons, protons and neutrons. They are organized into atoms and these atoms further combine to form molecules. These aspects have been explained in chapter one.

Chapter two includes the modern theories of chemical bonding and enables the students to understand the geometry of simple molecules.

Chemical thermodynamics and kinetics are fundamental to many disciplines other than chemistry. For example the most general problems of chemical thermodynamics are necessary for understanding of energy characteristics of chemical and physico-chemical processes of vital activity of organism. On the other hand the problems of chemical kinetics are necessary for pharmacokinetics and toxicology. These facts predisposed the laconic character of writing and led to inevitable simplification of the material given in chapter three and chapter four.

The chapter five describes the process of solution formation and thermodynamics of dissolving and shows that the dissolving is a spontaneous process. The concept of the ideal and non-ideal solutions is discussed. In this chapter we assess the colligative properties of solutions, paying special attention to their significance in medicine and pharmacology. We investigate the solution electrolytic behaviours in general.

The principles of dynamic acid-base equilibrium and the action mechanism of buffer solutions are given in chapter six.

The ions of some elements can attach other ions or neutral molecules and form more elaborate complex ions when the latter combine with ions of the opposite sign, various complex compounds are obtained. Chapter seven describes the formation and properties these complex compounds. General chemistry is closely connected with biology and medicine through biochemistry. In conjunction with pharmacology and medicine biochemistry will find ever more powerful means for fighting diseases. Chapter eight describes the theory of heterogeneous equilibria and explains their biochemical influence on the formation on bone tissue in a human body.

The chapter nine is a general introduction to electrical conduction of tissues and biological fluids. The application of conductometry in medical biologi-

cal research is described. Concept about the electrode and oxidation-reduction potentials is given.

The chapter ten includes the physico-chemistry of surface phenomena. In this chapter we examine surface energy and surface tension, surface active and surface inactive substances, concentrating mainly on the meaning of these properties in medicine.

The principles of chromatography are given in chapter eleven. Practical application of different types of chromatography in biology and medicine is described.

Certain phenomena connected with the colloidal state of matter are given in chapter twelve.

It is hoped that the guide will serve the needs of the students with respect to examination. We are conscious of the possible printing errors in this guide. We would welcome if these errors are brought to our notice.

CHAPTER 1

Basic concepts about the structure of matter

The atom is a complicated microsystem consisting of the moving elementary particles. It consists of a positively charged nucleus and negatively charged electrons. The main characteristics of the electron, proton, and neutron are given in table 1.1

Table 1.1

The Main Characteristics of Elementary Particles

Particle	Symbol	Rest mass, kg	Charge, C
Proton	p	1.673×10^{-27}	$+1.602 \times 10^{-19}$
Neutron	n	1.675×10^{-27}	0
Electron	e	9.1×10^{-31}	-1.602×10^{-19}

The properties of the nucleus depend mainly on its composition, i. e. on the number of protons and neutrons. The number of protons in the nucleus identifies the charge of the nucleus and its belonging to a given chemical element. Another important characteristic of the nucleus is the mass number (sign A) which is equal to the total number of protons (sign Z) and neutrons (sign N) in it as:

$$A = Z + N$$

Atoms with the same number of protons and with the different mass number are called isotopes. For example, chemical element hydrogen has three isotopes ^1H , ^2H , ^3H (where 1, 2 and 3 are mass numbers).

1.1. THE ELECTRON SHELL OF THE ATOM

Energy levels. Niels Bohr in 1913 made the revolutionary suggestion that the total energy (kinetic plus potential) of an electron in an atom is quantized, i. e.,

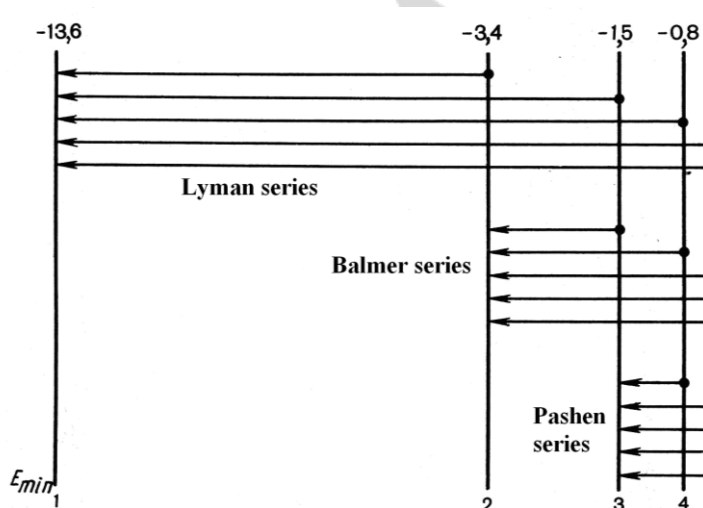

Fig. 1.1. Diagram of the energy levels and quantum transitions of the electron of a hydrogen atom

restricted to having only certain values. This means that in an atom an electron cannot have any energy but only certain specific values. The only way an electron can change its energy is in passing from one discrete energy level to another. If the electron is at a lower energy level, it can radiate energy, but only a definite amount. This amount of energy is equal to the difference between one energy level and another (fig. 1.1). The Bohr's

theory established the basis for quantum mechanics. It studies motion laws that govern the behaviour of small particles.

The wave nature of microparticles motion. Before all of the experiments mentioned above, it was known that all electromagnetic radiation could be described by the physics of waves, where the product of wavelength (λ) and frequency (ν) are equal to the velocity of light ($c = 2.998 \times 10^8$ m/s):

$$\lambda \nu = c$$

In 1924, Louis de Broglie proposed that an electron and other particles of comparable mass could also be described by the physics of waves. De Broglie suggested the extending corpuscular-wave concept to all microparticles, in which the motion of any microparticle is regarded as a wave process. Mathematically this is expressed by the de Broglie equation, according to which a particle of mass (m) moving at a velocity (ν) has a certain wavelength (λ):

$$\lambda = h / m \nu,$$

where h is the Planck's constant.

De Broglie's hypothesis was proved experimentally by the discovery of diffraction and interference effects in a stream of electron. According to the de Broglie equation the motion of an electron with the mass equal to 9.1×10^{-31} kg and the velocity equal to 10^8 m/s is associated with a wavelength equal to 10^{-10} metres, i. e. the wavelength approximately equals to the atom's size. When a beam of electrons is scattered by a crystal, diffraction is observed. The crystal acts as a diffraction lattice.

The uncertainty principle. In 1927, Werner Heisenberg set for the first time the uncertainty principle according to which it is impossible to determine accurately both the position (or coordinates) and the velocity of motion of a microparticle simultaneously. The mathematical expression of the uncertainty principle is:

$$\Delta x \cdot \Delta \nu > h/2\pi m$$

where Δx , $\Delta \nu$ are uncertainties of the position and velocity of a particle respectively.

It follows from equation that the higher the accuracy of a particle the coordinate the determination, the less certain the value of its velocity is. Thus the state of an electron in an atom cannot be represented as the motion of a material particle along the orbit. Quantum mechanics uses the idea of a statistical probability of finding the electron at a definite point in space around the nucleus. The position of the electron is not know with certainty, however; only the probability of the electron being in a given region of space can be calculated.

The electron cloud. Quantum mechanics is a new branch of physics. It describes the motion and interaction of microparticles. The model of an electron in an atom accepted in quantum mechanics is the idea of an electron cloud. Let us assume that we have photographed the position of an electron at some moment of

time in the three-dimensional space around the nucleus. The position of an electron is shown on the photographs as a dot (fig. 1.2). If we repeat the experience thousands of times, the new photographs taken at short intervals, will discover the electron in new positions. When all the photographs are superimposed on one another, we will get a picture resembling a cloud. A possible form of the electron cloud in an atom is shown in fig.1.3.

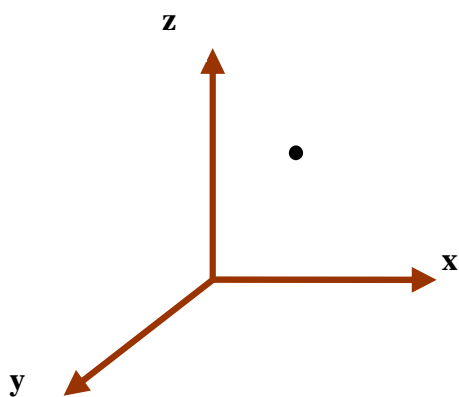

Fig. 1.2. The position of an electron

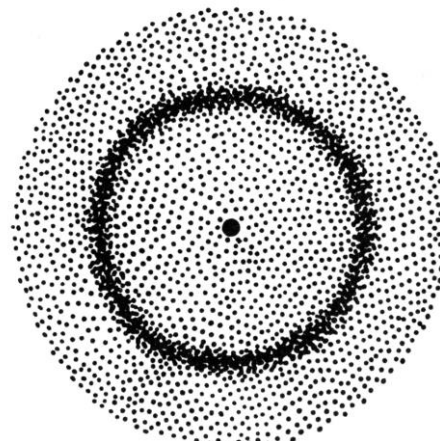

Fig. 1.3. A possible form of the electron cloud in an atom

The cloud will be the densest where the number of dots is the greatest, i. e. where probability of finding the electron in the cloud is the highest.

The stronger the bond between the nucleus and the electron the smaller the electron cloud will be and the denser the distribution of the charge. The space around the nucleus in which the probability of finding the electron is the highest is called the orbital. The configuration and size of the electron cloud is usually regarded as the shape and size of the orbital.

1.2. THE QUANTUM NUMBERS

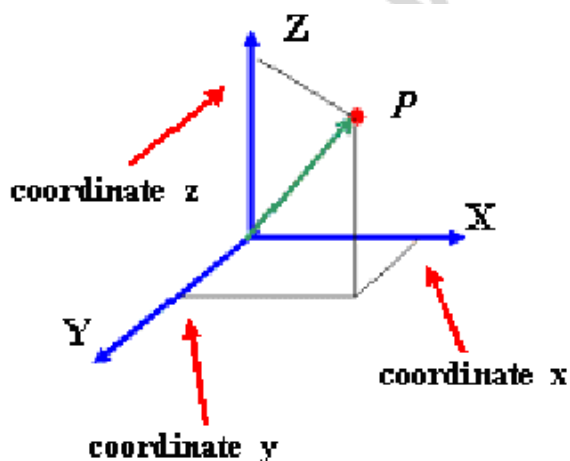

Fig. 1.4. The Cartesian coordinate system. The position of a point P in space can be specified by giving the x, y and z coordinates

In a three-dimensional world, three parameters are required to describe the location of an object in space (fig. 1.4). The position of a point P in space can be specified by giving the x, y, and z coordinates.

For the atomic electron, this requirement leads to the existence of three quantum numbers: n , ℓ , and m_ℓ , which define an orbital by giving the electron shell, the subshell, and the orbital within that subshell.

In case of the hydrogen atom, the first of these three quantum numbers alone is sufficient to describe the energy of the electron, but all three are needed to define the probability of finding that electron in a given region of space.

The principal quantum number n can have any integer value from 1 to infinity: $n = 1, 2, 3...$ It is the most important quantum number because its value determines the total energy of the electron. The value of n also gives a measure of the most probable distance of the electron from the nucleus: the greater the value of n , the more probable it is that the electron is found further from the nucleus.

An earlier notation used letters for the major electron shells: K, L, M, N, and so on, corresponding to $n = 1, 2, 3, 4$, and so on. That is, n is a measure of the orbital radial size or diameter.

In atoms having more than one electron, two or more electrons may have the same n value. These electrons are then said to be in the same electron shell, the shells being numbered according to their major quantum number.

The angular momentum quantum number ℓ is related to the shape of electron orbitals, and the number of values of ℓ for a given value of n states how many different orbital types or electron subshells there are in a particular electron shell: ℓ , the angular momentum quantum number = $0, 1, 2... (n - 1)$.

The integer values that ℓ may have are limited by the value of n : ℓ may be an integer from 0 up to and including $n - 1$. In other words, if n is 1, then there is only one ℓ value possible; ℓ can only be 0, and there can only be one type of the orbital or subshell in the $n = 1$ electron shell. In contrast, when $n = 4$, ℓ can have four values of 0, 1, 2, and 3. Because there are four values of ℓ , there are four orbital types or four subshells within the fourth major quantum shell.

The values of the ℓ quantum number are usually coded by a letter according to the scheme below.

Value of ℓ	Corresponding orbital label
0	s
1	p
2	d
3	f

Thus, for example, a subshell with a label of $\ell = 1$ is called a «p subshell», and an orbital found in that subshell is called a «p orbital».

Electron orbitals are labeled by first giving the value of n and then the value of ℓ in the form of its letter code. For $n = 1$ and $\ell = 0$, the label is 1s.

For a given n , there will be n values of ℓ and n orbital types; this means there is a total of n^2 orbitals in the n th shell.

Magnetic quantum number. The first quantum number (n) locates the electron in a particular electron shell, and the second (ℓ) places it in a particular subshell of orbitals within the shell.

The third quantum number (m_ℓ) then specifies in which orbital within the subshell the electron is located; m_ℓ is related to the spatial orientation of an orbital in a given subshell.

The number of m_ℓ values = the number of orbitals in a subshell. The integer values that m_ℓ may have are limited by ℓ ; m_ℓ values can range from $+\ell$ to $-\ell$ with 0 included: $m_\ell = 0, \pm 1, \pm 2, \pm 3, \dots \pm m_\ell$.

For example, when $\ell = 2$, m_ℓ has the five values $+2, +1, 0, -1, -2$. The number of values of m_ℓ for a given ℓ states how many orbitals of a given type there are in that subshell (table 1.2).

Table 1.2

Summary of the Quantum Numbers, Their interrelationships

Principal quantum number	Angular momentum	Magnetic quantum number	Number and type of orbitals in the subshell
Symbol = n Values = 1, 2, 3... (Orbital size, Energy)	Symbol = ℓ Values = 0... ($n-1$) (Orbital Shape)	Symbol = m_ℓ Values = $-1...0...+1$ (Orbital Orientation)	Number = number of values of $m_\ell = 2\ell + 1$ (Orbitals in a Shell = n^2)
1	0	0	1 1s orbital (1 orbital in the $n = 1$ shell)
2	0 1	0 $+1, 0, -1$	1 2s orbital 3 2p orbital (4 orbitals of 2 types in the $n = 2$ shell)
3	0 1 2	0 $+1, 0, -1$ $+2, +1, 0, -1, -2$	1 3s orbital 3 3p orbital 5 3d orbital (9 orbitals of 3 types in the $n = 3$ shell)
4	0 1 2 3	0 $+1, 0, -1$ $+2, +1, 0, -1, -2$ $+3, +2, +1, 0, -1, -2, -3$	1 4s orbital 3 4p orbital 5 4d orbital 7 4f orbital (16 orbitals of 4 types in the $n = 4$ shell)

Electron spin. Three quantum numbers (n , ℓ , and m_ℓ) allow us to define the orbital for an electron. To describe completely an electron in an atom with many electrons, however, we still need one more quantum number, the electron spin quantum number, m_s .

In approximately 1920, theoretical chemists realized that, since electrons interact with a magnetic field, there must be one more concept to explain the behaviour of electrons in atoms.

It was soon verified experimentally that the electron behaves as though it has a spin. This spin is much like that of the earth spinning on its axis, and, since the electron is electrically charged, the spinning charge generates a magnetic

field with north and south magnetic poles (fig. 1.5); that is, the electron acts like a tiny bar magnet.

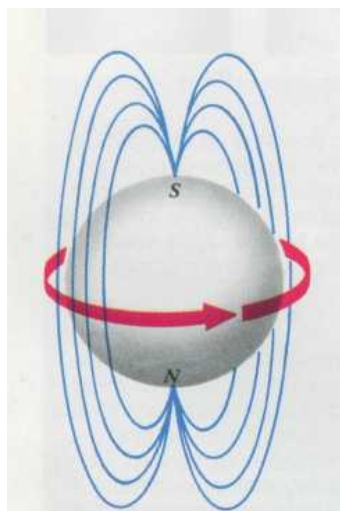

Fig. 1.5. Electron spin

The properties of magnets are related to the number of unpaired electrons in the atoms of which the magnet is composed. Thus, as expected, hydrogen atoms are paramagnetic to the extent of one unpaired electron. Helium atoms, which have two electrons, are not paramagnetic, however. The explanation for this experimental observation rests on two hypotheses: (1) the two electrons are assigned to the same orbital and (2) electron spin is quantized. The quantization of electron spin means that there are only two possible orientations of an electron in a magnetic field, one associated with a spin quantum number, m_s , of $+1/2$ and the other with an m_s value of $-1/2$. To account for the lack of paramagnetism of helium, we must assume the two electrons assigned to the same orbital have opposite spin directions; we say they are paired.

The implications of this observation are enormous and open the way to explain the electron configurations of atoms with more than one electron.

The shapes of atomic orbitals. When an electron has a value of $\ell = 0$, we say the electron occupies an s orbital.

All s orbitals are spherical in shape, but the 2s cloud is larger than the 1s cloud (fig. 1.6.): the point of maximum probability for the 2s electron is found slightly farther from the nucleus than that of the 1s electron.

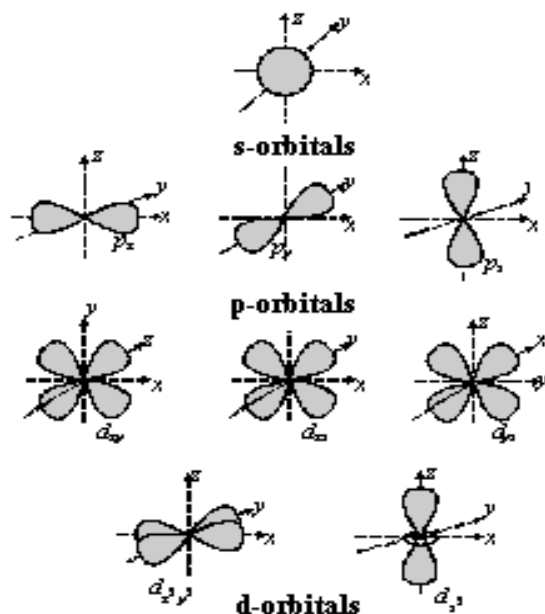

Fig. 1.6. The shapes of atomic orbitals

Atomic orbitals for which $\ell = 1$ are called p orbitals.

According to table 1.2, when $\ell = 1$, then m_ℓ can only be +1, 0 and -1. That is, there are three types of $\ell = 1$ or p orbitals. Since there are three mutually perpendicular directions in space (x, y, and z), the p orbitals are commonly visualized as lying along these directions, and they are labeled according to the axis along which they lie (p_x , p_y and p_z).

When $\ell = 2$, then m_ℓ can only be +2, +1, 0, -1 and -2. There are five types of $\ell = 2$ or d orbitals.

1.3. ELECTRON CONFIGURATIONS OF ELEMENTS

The Pauly principle. To make the quantum theory consistent with experiment, Wolfgang Pauli stated in 1925 the Pauli exclusion principle: No two electrons in an atom can have the same set of four quantum numbers (n , ℓ , m_ℓ , and m_s). This principle leads to yet another important conclusion, that no atomic orbital can be assigned to (or «contain») more than two electrons. If we consider the 1s orbital of the H atom, this orbital is defined by the set of quantum numbers $n = 1$, $\ell = 0$ and $m_\ell = 0$. No other set of numbers can be used. If an electron has this orbital, the electron spin direction must also be specified.

The orbital is shown as a «box», and the electron spin in one direction is depicted by an arrow:

Electron in 1s orbital



Quantum Number Set

$$n = 1, \ell = 0, m_\ell = 0, m_s = +1/2$$

If there is only one electron with a given orbital, you can picture the electron as an arrow pointing either up or down.

Thus, an equally valid combination of quantum numbers and a «box» diagram would be:

Electron in 1s orbital



Quantum Number Set

$$n = 1, \ell = 0, m_\ell = 0, m_s = -1/2$$

The pictures above are appropriate for the H atom in its ground state: one electron in the 1s orbital.

For the helium atom, the element with two electrons, both electrons are assigned to the 1s orbital. From the Pauli principle, you know that each electron must have a different set of quantum numbers, so the orbital box picture now is

Two electrons in the 1s orbital of He atom:

this electron has $n = 1$, $\ell = 0$, $m_\ell = 0$, $m_s = -1/2$

this electron has $n = 1$, $\ell = 0$, $m_\ell = 0$, $m_s = +1/2$

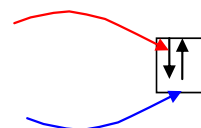

The Order of orbital energies and assignments. Generally, electrons are assigned to orbitals of successively higher energies because this will make the total energy of all the electrons as low as possible. The order of orbital energies is given in fig. 1.7.

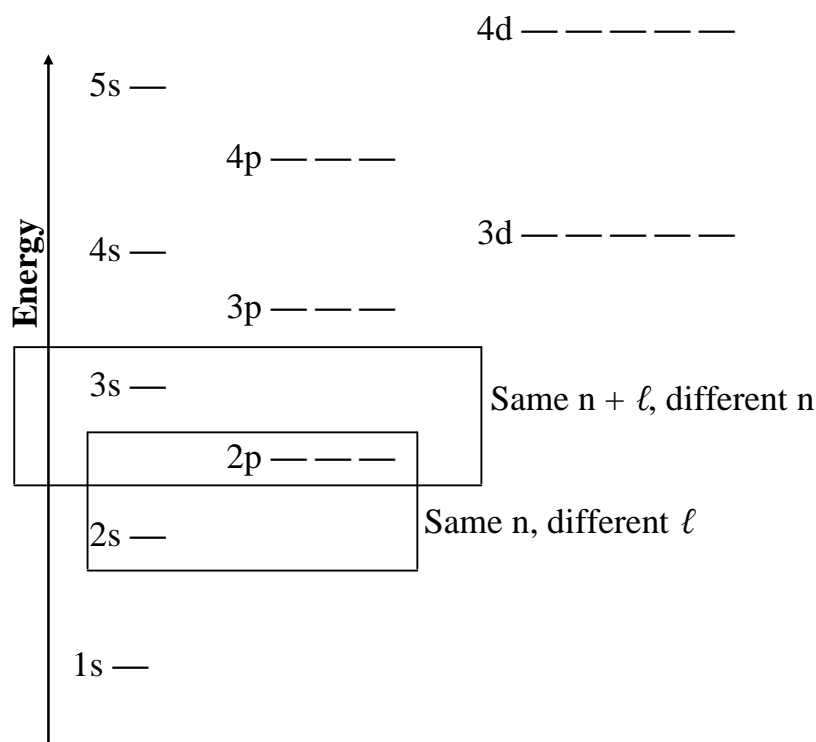

Fig. 1.7. The order of orbital energies

Here you see that orbital energies of many-electron atoms depend on both n and ℓ . The orbitals with $n = 3$, for example, do not all have the same energy; rather, they are in the order $3s < 3p < 3d$. The orbital energy order in fig. 1.7, and the determination of the actual electron configurations of the elements, lead to two general rules for the order of assignment of electrons to orbitals.

1. Orbital assignments follow a sequence of increasing $n + \ell$.
2. For two orbitals of the same $n + \ell$, electrons are assigned first to orbitals of lower n .

These rules mean electrons are usually assigned in order of increasing orbital energy. However, there are exceptions. For example, electrons are assigned to a 4s orbital ($n + \ell = 4$) before being assigned to 3d orbitals ($n + \ell = 5$). This order of assignment is observed in spite of the fact that the energies of these orbitals are in the order $3d < 4s$ (fig. 1.7).

Electron configurations of the main group elements. Configurations of the first ten elements are illustrated in table 1.3. The first two electrons must be assigned to the 1s orbital, so the third electron must use the $n = 2$ shell. According to the energy level diagram in fig. 1.8, that electron must be assigned to the 2s orbital. The spectroscopic notation: $1s^2 2s^1$ is read as «one es two, two es one».

Electron Configurations of the Elements with $Z = 1$ to 10

	ℓ	$1s$	$2s$	$2p$
	m_ℓ	0	0	+1 0 -1
H $1s^1$		↑		
He $1s^2$		↑↓		
Li $1s^2 2s^1$		↑↓	↑	
Be $1s^2 2s^2$		↑↓	↑↓	
B $1s^2 2s^2 2p^1$		↑↓	↑↓	↑
C $1s^2 2s^2 2p^2$		↑↓	↑↓	↑ ↑
N $1s^2 2s^2 2p^3$		↑↓	↑↓	↑ ↑ ↑
O $1s^2 2s^2 2p^4$		↑↓	↑↓	↑↓ ↑ ↑
F $1s^2 2s^2 2p^5$		↑↓	↑↓	↑↓ ↑↓ ↑
Ne $1s^2 2s^2 2p^6$		↑↓	↑↓	↑↓ ↑↓ ↑↓

The position of Li atom in the periodic table tells you its configuration immediately. All the elements of Group 1A (and IB) have one electron assigned to an s orbital of the nth shell, where n is the number of the period in which the element is found.

For example, potassium is the first element in the $n = 4$ row, so potassium has the electron configuration of the element preceding it in the table (Ar) plus a final electron assigned to the 4s orbital.

Copper, in Group IB, will also have one electron assigned to the 4s orbital, plus 28 other electrons assigned to other orbitals.

The configuration of Be $1s^2 2s^2$. All elements of Group 2A have electron configurations [electrons of preceding rare gas + ns^2], where n is the period in which the element is found in the periodic table.

At boron (Group 3A) you first encounter an element in the block of elements on the right side of the periodic table. Since the 1s and 2s orbitals are filled in a boron atom, the fifth electron must be assigned to a 2p orbital, the configuration of B atom $1s^2 2s^2 2p^1$. In fact, all the elements from Group 3A through Group 8A are characterized by electrons assigned to p orbitals, so these elements are sometimes called the p block elements. All have the general configuration of $ns^2 np^x$ where $x =$ group number .

Carbon (Group 4A) is the second element in the p block, so there is a second electron assigned to the 2p orbitals: the configuration of C $1s^2 2s^2 2p^2$.

In general, when electrons are assigned to p, d, or f orbitals, each electron is assigned a different orbital of the subshell, each electron having the same spin as the previous one; this proceeds until the subshell is half full, after which pairs of electrons must be assigned a common orbital.

This procedure follows the *Hund's rule*, which states that the most stable arrangement of electrons is that with the maximum number of unpaired electrons, all with the same spin direction. Electrons are negatively charged particles, so assignment to different orbitals minimizes electron-electron repulsions, making the total energy of the set of electrons as low as possible. Giving them the same spin also lessens their repulsions.

Electron configurations of the transition elements. The 3s and 3p subshells are filled at argon, and the periodic table indicates that the next element is potassium, the first element of the fourth period. This means, though, that potassium must have the configuration $1s^2 2s^2 2p^6 3s^2 3p^6 4s^1$ ([Ar] $4s^1$), a configuration given by the $(n + \ell)$ rule.

After electrons have been assigned to the 4s orbital, the 3d orbitals are those next utilized. Accordingly, scandium must have the configuration [Ar] $3d^1 4s^2$ and titanium follows with [Ar] $3d^2 4s^2$ and vanadium with [Ar] $3d^3 4s^2$. Notice in the orbital box diagrams in table 1.4 that one electron is assigned to each of the five possible d orbitals and that all have the same spin direction.

On arriving at chromium, we come to what some might call an anomaly in the order of orbital assignment. For complex reasons, among them the minimization of electron-electron repulsions, chromium has one electron assigned to each of the six available 4s and 3d orbitals.

Table 1.4

Orbital Box Diagrams for the Elements Ca Through Zn

		$3d$					$4s$
		+2	+1	0	-1	-2	0
Ca	[Ar] $4s^2$						$\uparrow\downarrow$
Sc	[Ar] $3d^1 4s^2$	\uparrow					$\uparrow\downarrow$
Ti	[Ar] $3d^2 4s^2$	\uparrow	\uparrow				$\uparrow\downarrow$
V	[Ar] $3d^3 4s^2$	\uparrow	\uparrow	\uparrow			$\uparrow\downarrow$
Cr*	[Ar] $3d^5 4s^1$	\uparrow	\uparrow	\uparrow	\uparrow	\uparrow	\uparrow
Mn	[Ar] $3d^5 4s^2$	\uparrow	\uparrow	\uparrow	\uparrow	\uparrow	$\uparrow\downarrow$
Fe	[Ar] $3d^6 4s^2$	$\uparrow\downarrow$	\uparrow	\uparrow	\uparrow	\uparrow	$\uparrow\downarrow$
Co	[Ar] $3d^7 4s^2$	$\uparrow\downarrow$	$\uparrow\downarrow$	\uparrow	\uparrow	\uparrow	$\uparrow\downarrow$
Ni	[Ar] $3d^8 4s^2$	$\uparrow\downarrow$	$\uparrow\downarrow$	$\uparrow\downarrow$	\uparrow	\uparrow	$\uparrow\downarrow$
Cu*	[Ar] $3d^{10} 4s^1$	$\uparrow\downarrow$	$\uparrow\downarrow$	$\uparrow\downarrow$	$\uparrow\downarrow$	$\uparrow\downarrow$	\uparrow
Zn	[Ar] $3d^{10} 4s^2$	$\uparrow\downarrow$	$\uparrow\downarrow$	$\uparrow\downarrow$	$\uparrow\downarrow$	$\uparrow\downarrow$	$\uparrow\downarrow$

1.4. THE PERIODIC TABLE. ATOMIC PROPERTIES AND PERIODIC TRENDS

Atomic size. For the main group elements, atomic radii increase going down a group in the periodic table and decrease going across a period (fig. 1.8).

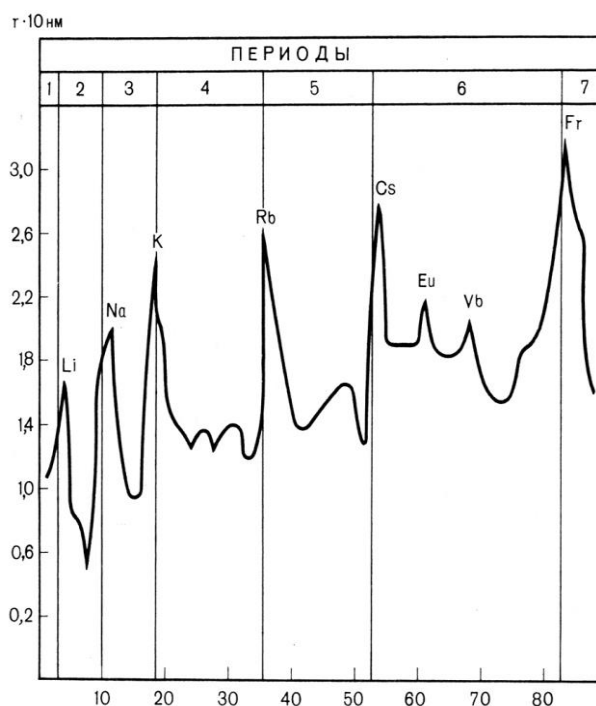

Fig. 1.8. Atomic radii of the elements

The reason atomic radii increase on descending a periodic group is clear. Going down Group 1A, for example, the last electron added is always assigned to an s orbital and is in the electron shell beyond that used by the electrons of the elements in the previous period. The inner electrons shield or screen the nuclear charge from the outermost ns¹ electron, so the last electron feels an effective nuclear charge, Z, of approximately +1. Since, on descending the group, the ns¹ electron is most likely found at greater and greater distances from the nucleus, the atom size must increase.

When moving across a period of main group elements, the size decreases because the effective nuclear charge increases.

Ionization energy. The ionization energy of an atom is the energy required to remove electron from an atom or ion in the gas phase: Atom in ground state (g) + energy → Atom⁺ (g) + e⁻, ΔE = ionization energy (IE)

The process of ionization involves moving an electron from a given electron shell to a position outside the atom. Energy is always required, so the process is endothermic and the sign of the ionization energy is always positive.

Each atom can have a series of ionization energies, since more than one electron can always be removed (except for H). For example, the first three ionization energies of Mg_(g) are:

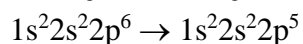
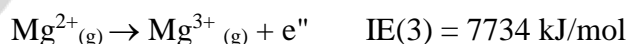
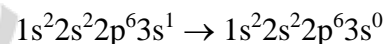
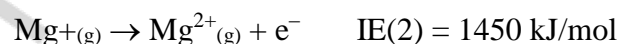
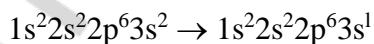

For the main group or A-type elements, first ionization energies generally decrease down a periodic group and increase across a period. The ionization energy decrease going down the table occurs for the same reason that the size in-

creases in this direction: the first-removed electron is farther and farther from the nucleus and so less and less energy is required for its removal. There is a general increase in ionization energy when moving across a period of the periodic table due to an ever increasing effective nuclear charge. The trend, however, is not smooth (fig. 1.9), and its peaks and valleys give us further insight into atomic structure. First, in spite of the general trend, the ionization energy for boron is less than that for beryllium. The reason for this is that the 2s orbital of beryllium is lower in energy than the boron 2p orbital. Therefore, less energy is required to remove the boron 2p electron than the 2s electron of beryllium.

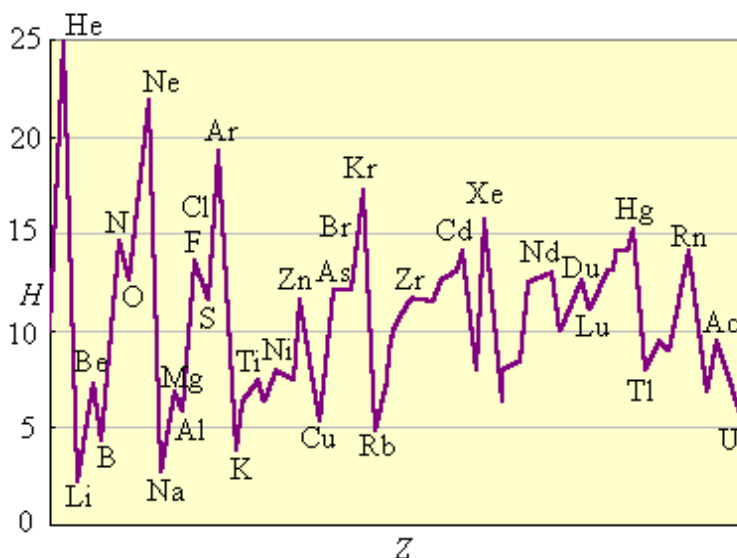

Fig. 1.9. First ionization energies of the elements

Electron affinity. A measure of the electron affinity of an element is the energy involved when an electron is brought from an infinite distance away up to a gaseous atom and absorbed by it to form a gaseous ion.



When a stable anion is formed, energy is released and the sign of the energy change is negative. The greater the electron affinity the more negative the value of EA. Fluorine, for example, has an electron affinity of -322 kJ/mol . The value of EA for the first ten elements is shown in table 1.5.

Table 1.5

Electron Affinities for the first and the second period elements

	H	He	Li	Be	B	C	N	O	F	Ne
EA, eV	0,75	-0,22	0,8	-0,19	0,30	1,27	-0,21	1,47	3,45	-0,57

$\text{F}_{(g)} + e^{-} \rightarrow \text{F}^{-}_{(g)} + 322 \text{ kJ/mol}$. The periodic trends in electron affinity are closely related to those for ionization energy and size.

There is a general increase across a period due to the general increase in Z, but there is evidence again for the competing effects of electron-electron repulsions and changes in nuclear charge. For example, just as electron-electron repulsions cause the ionization energy of oxygen to be lower than expected, the same effect

means nitrogen has almost no affinity for an electron: $\text{N}_{(g)} + e^- \rightarrow \text{N}^-_{(g)}$, no energy evolved or required.

When descending a periodic group, we expect the electron affinity to decrease for the same reason that the atom size increases and ionization energy decreases.

CHAPTER 2 Chemical Bond

2.1. VALENCE ELECTRONS

The outermost electrons of an atom, are the electrons affected the most by the approaching of another atom. They are called valence electrons. The rare gas core electrons and the filled *d*-shell electrons of Group 3A elements are not greatly affected by reactions with other atoms, so we focus our attention on the behaviour of the outer *ns* and *np* electrons (and *d* electrons in unfilled subshells of the transition metals). The valence electrons for a few typical elements are:

Core element	Electrons	Valence electrons	Periodic group
Na	$1s^2 2s^2 2p^6$	$3s^1$	1A
Si	$1s^2 2s^2 2p^6$	$3s^2 3p^2$	4A
Ti	$1s^2 2s^2 2p^6 3s^2 3p^6$	$4s^2 3d^2$	4B
As	$1s^2 2s^2 2p^6 3s^2 3p^6 3d^{10}$	$4s^2 4p^3$	5A

From the table above you see that the number of valence electrons of each element is equal to the group number. The fact that every element in a given group has the same number of valence electrons accounts for the similarity of chemical properties among members of the group.

A useful device for keeping track of the valence electrons of the main group elements is the Lewis electron dot symbol, first suggested by Lewis, in 1916. In this notation, the nucleus and core electrons are represented by the atomic symbol. The valence electrons, represented by dots, are then placed around the symbol one at a time until they are used up or until all four sides are occupied; any remaining electrons are paired with the existing electrons. The Lewis symbols for the first two periods are:

1A	2A	3A	4A	5A	6A	7A	8A
ns^1	ns^2	$ns^2 np^1$	$ns^2 np^2$	$ns^2 np^3$	$ns^2 np^4$	$ns^2 np^5$	$ns^2 np^6$
•Li	•Be•	•B•	•C•	•N•	•O•	•F•	•Ne•
•Na	•Mg•	•Al•	•Si•	•P•	•S•	•Cl•	•Ar•

The Lewis symbol emphasizes the rare gas configuration, $ns^2 np^6$, as a stable, low-energy state. In fact, the bonding behaviour of the main group elements can often be considered as being the result of gaining, losing, or sharing valence

electrons to achieve the same configuration as the nearest rare gas. All rare gases (except He) have eight valence electrons, this observation is called the *octet rule*. The view of covalent bonding just described implies that each unpaired valence electron in the Lewis structure of an isolated atom is available for sharing with another atom to form one bond. For example, the number of unpaired electrons on an atom of Groups 4A through 8A is just 8 minus the group number. (The number of unpaired electrons is equal to the group number for Groups 1A to 3A, but these elements, except boron, usually form ionic rather than covalent compounds.) For example, oxygen in Group 6A has $8 - 6 = 2$ unpaired electrons and forms 2 bonds.

2.2. IONIC BOND

One type of chemical bond is the ionic bond in which electrons are completely transferred from one atom to another. The formation of an ionic bond takes place in the reaction between the atom of low ionization energy with an atom of high electron affinity. An example of such a reaction is the reaction between sodium atoms and chlorine. A sodium atom has a low ionization energy: i.e. not much energy is required to pull off the outer electron.

A chlorine atom has a high electron affinity: i. e. considerable energy is released when an electron is added to its outer shell. Suppose these two atoms come together.

As shown in fig. 2.1 sodium initially has one valence electron, and chlorine has seven.

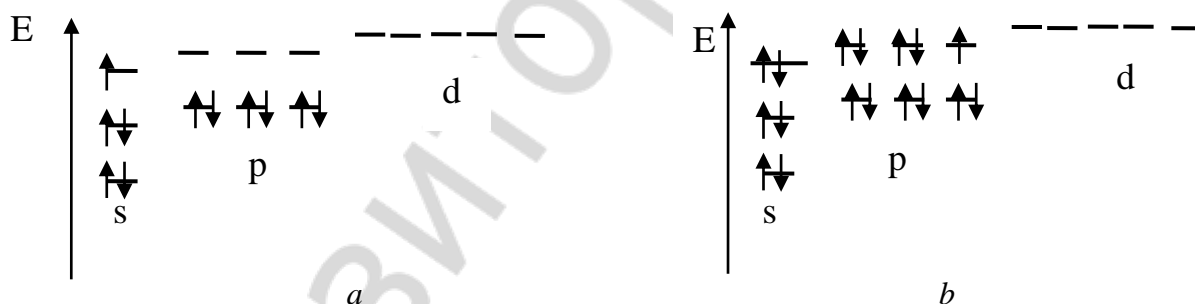
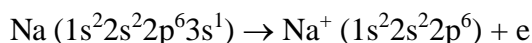

Fig. 2.1. Formation of an ionic bond:
a — sodium atom, *b* — chlorine atom

In case when electron transfer, chlorine has eight valence electrons. The chlorine has a negative charge because of the gain of an electron. Now the sodium has a positive charge because of the loss of a negative electron. Thus, a positive ion and a negative ion are formed. Because the ions have opposite electric charges, they attract each other to produce an ionic bond. The formation of an ionic bond has three steps:

Step 1. Sodium loses its outer electron and becomes positively charged



Step2. Chlorine gains an electron and becomes negatively charged

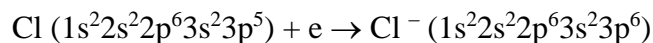

Step3. Sodium and chlorine ions combine and NaCl is formed

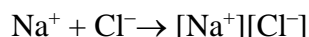

Since, in general, the elements on the left of the periodic table have low ionization potentials and the elements on the right have high electron affinity, mainly ionic bonds are formed (in reactions between these elements).

2.3. CHEMICAL BOND FORMATION

In case of a ionic bond where metals from the left side of the periodic table interact with nonmetals from the far right side, the result is usually the complete transfer of one or more electrons from one atom to another and the creation of an ionic bond.



When the elements lie closer in the periodic table, electrons are more often shared between atoms and the result is a covalent bond.



When two atoms approach each other closely enough for their electron clouds to interpenetrate, the electrons and nuclei repel each other; at the same time each atom's electrons attract the other atom's nucleus. If the total attractive force is greater than the total repulsive force, a covalent bond is formed (fig. 2.2).

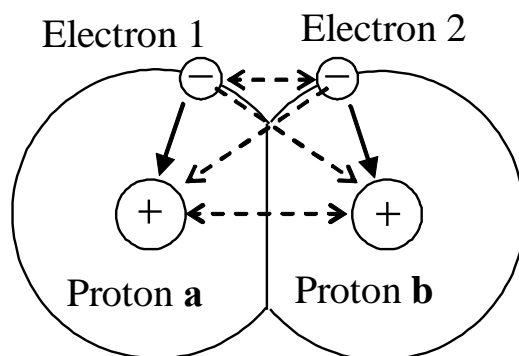

Fig. 2.2. The formation of a covalent bond in H_2 molecule. Pair of electrons (one electron from each atom) flows into the internuclear region and is attracted to both nuclei. It is this mutual attraction of 2 (or sometimes 4 or 6) electrons by two nuclei that leads to a force of attraction between two atoms and assists in bond formation.

The second view of bonding, based on quantum mechanics, is more adaptable to mathematical analysis, but a bit harder to visualize. Here we imagine combining an atomic orbital from each of the two atoms to form a *bond orbital*.

Like an atomic orbital, a bond orbital can describe either one or two electrons; if there are two electrons (a bond pair) in a bond orbital, they must be

paired with opposite spins. All the valence electrons of the atoms not involved in bonding are described by lone-pair orbitals, which are concentrated outside the bond region. The more the attraction between the bonding electrons and the nuclei exceeds the repulsion between the nuclei and between lone electron pairs, the stronger the bond will be between the atoms. Of course, a stronger bond means a more stable molecule with a lower potential energy.

The diagram in fig. 2.3 shows the energy changes as a pair of electrons initially associated with separate H atoms becomes a bonding pair in H₂. The energy of the electrons in a bond orbital, where the electrons are attracted by two nuclei, is lower than their energy in valence atomic orbitals. There is also a quantum mechanical effect related to the size of the bond region compared to the size of the atomic orbital; because the electron is free to move in a larger space, its kinetic energy is lower. This effect is quite important in explaining certain types of bonds but we shall not explore it further.

Thus, in general, electrons fall to a lower potential energy when they become bonding electrons, and this energy is given off in the form of heat and/or light.

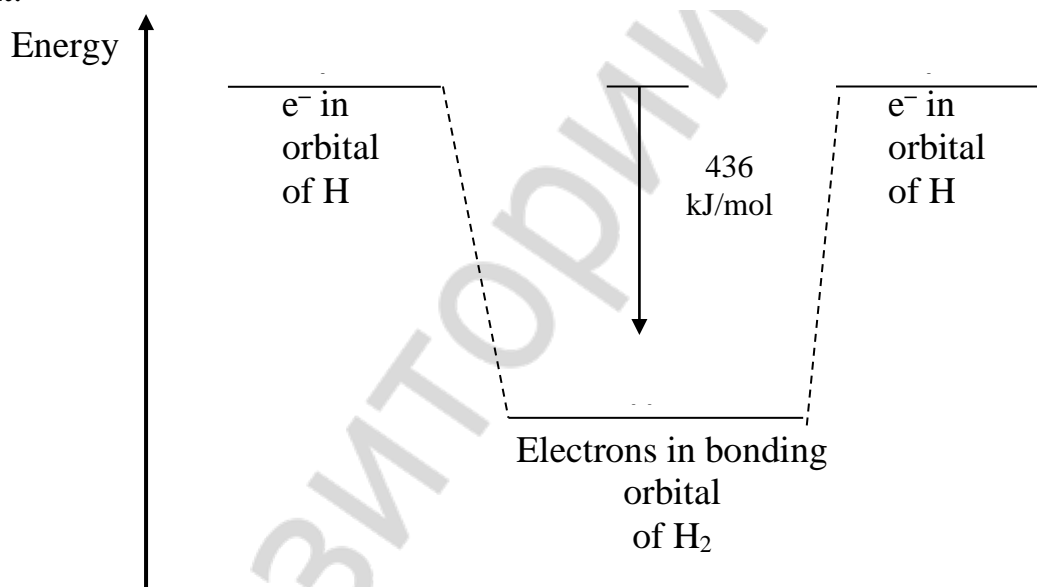

Fig. 2.3. Energy changes occurring in the process of bond formation between two H atoms

2.4. PROPERTIES OF COVALENT BOND

Single and multiple bonds. Molecules H-H, H-Be-H, H-O-H have a single pair of electrons (a **single bond**) between atoms. Single bonds are also called sigma bonds, symbolized by the Greek letter σ . Other structures, for example H₂C=CH₂, N \equiv N indicate two or three electron pairs (a multiple bond) between the same pair of atoms. In a double or triple bond, one of the bonds is a sigma bond, but the second (and third if present) is a pi bond, denoted by the Greek letter π . Multiple bonds are most often formed by C, N, O and S atoms.

The donor–accepter mechanism of formation of covalent bond. In all of the compounds shown so far each atom contributes one unpaired electron to a bond pair, as in $\text{H}\cdot + \cdot\text{H} \rightarrow \text{H}:\text{H}$

Some elements, such as nitrogen and phosphorus, tend to share a lone pair with another atom that is short of electrons, leading to the formation of a coordinate covalent bond:

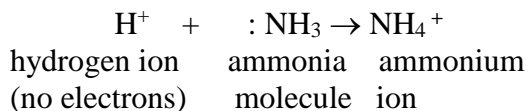

Once such a bond is formed, it is the same as any other bond; in the ammonium ion, for instance, all four bonds are identical.

The bond order. The bond order is the number of bonding electron pairs shared by two atoms in a molecule. Various molecular properties can be understood by this concept, including the distance between two atoms (bond length) and the energy required to separate the atoms from each other (bond energy).

BOND ORDER = 1. The bond order is 1 when there is only a sigma bond between the two bonded atoms. Examples are the single bonds in the following molecules.



BOND ORDER = 2. The order is 2 when there are two shared pairs between two atoms. One of these pairs forms a sigma bond and the other pair forms a pi bond. Examples are the $\text{C}=\text{O}$ bonds in CO_2 and the $\text{C}=\text{C}$ bond in ethylene, C_2H_4 .

BOND ORDER = 3. An order of 3 occurs when two atoms are connected by one sigma bond and two pi bonds. Examples are the carbon-carbon bond in acetylene (C_2H_2), the carbon-oxygen bond in carbon monoxide (CO), and the carbon-nitrogen bond in the cyanide ion (CN^-).

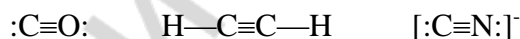

Bond length. The most important factor determining **bond length**, the distance between two bonded atoms, is the sizes of the atoms themselves. For

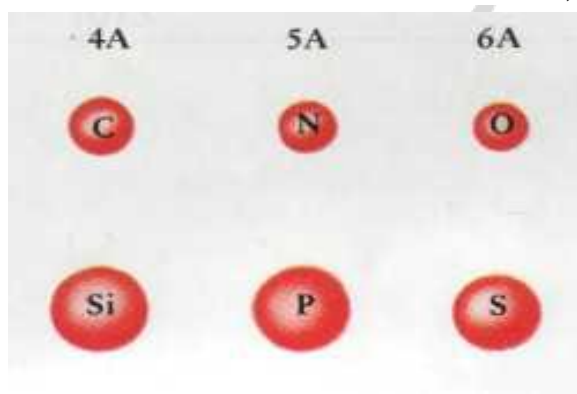

given elements, the order of the bond then determines the final value of the distance. Atom sizes vary in a fairly smooth way with the position of the element in the periodic table (fig. 2.4).

When you compare bonds of the same order, the bond length will be greater for the larger atoms. Thus, bonds involving carbon and another element would increase in length along the series

Fig. 2.4. Relative Atom Sizes for Groups 4A, 5A, and 6A.

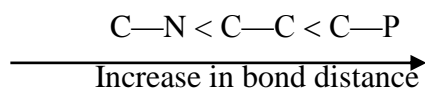

Similarly, a C=O bond will be shorter than a C=S bond, and a C≡N bond will be shorter than a C≡C bond.

The effect of bond order is evident when you compare bonds between the same two atoms. For example, the bonds become shorter as the bond order increases in the series C—O, C=O, and C≡O.

Bond	C—O	C=O	C≡O
Bond Order	1	2	3
Bond Length (pm)	143	122	113

Adding a π bond to the sigma bond in C—O shortens the bond by only 21 pm on going to C=O, rather than reducing it by half as you might have expected. The second π bond results in a 9 pm reduction in bond length from C=O to C≡O.

Bond energy. The greater the number of bonding electron pairs between a pair of atoms, the shorter the bond. This implies that atoms are held together more tightly when there are multiple bonds, and so it should not be surprising that there is a relation between the bond order and the energy required to separate atoms.

Suppose you wish to separate, by means of chemical reactions, the carbon atoms in ethane (H₃C—CH₃), ethylene (H₂C=CH₂), and acetylene (HC≡CH) for which the bond orders are 1, 2, and 3, respectively. For the same reason that the ethane C—C bond is the longest of the series, and the acetylene C≡C bond is the shortest, the separation will require the least energy for ethane and the most energy for acetylene.

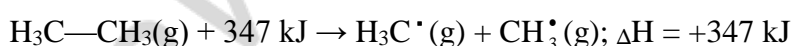
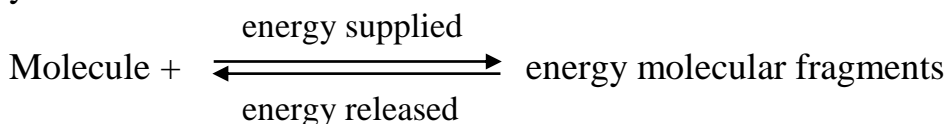

The energy that must be supplied to a gaseous molecule to separate two of its atoms is called the *bond dissociation energy* (or *bond energy* for short) and is given the symbol E_b . As E_b represents energy supplied to the molecule from its surroundings, E_b has a positive value, and the process of breaking bonds in a molecule is always endothermic. The amount of energy supplied to break the carbon-carbon bonds in the molecules above must be the same as the amount of energy released when the same bonds form. The formation of bonds from atoms in the gas phase is always exothermic. This means, for example, that ΔH for the formation of H₃C—CH₃ from two CH₃[•](g) fragments is -347 kJ/mol .

Polarity and electronegativity. Oxidation numbers. Covalent bonds are classified as polar or nonpolar. For example, the bonds in H₂ and Cl₂ are called nonpolar the bonds in HCl are polar. Not all atoms hold onto their valence elec-

trons with equal strength. The elements all have different values of ionization energy and electron affinity. If two different elements form a bond, the one with higher electronegativity will attract the shared pair more strongly than the other. Only when two atoms of the same kind form a bond we can presume that the bond pair is shared equally between the two atoms.

In H_2 and Cl_2 the «center of gravity» of the negative-charge distribution is at the center of the molecule, since the shared pair is distributed equally over the two atoms. In H_2 and Cl_2 contain an equal number of positive and negative charges (protons and electrons). Also the center of the positive charge coincides with the center of the negative charge. The molecule is a nonpolar molecule; it contains a nonpolar bond because an electron pair is shared equally between two atomic kernels. In case of HCl , the bond is called polar because the center of positive charge does not coincide with the center of negative charge. The formation of hydrogen chloride can be expressed as follows:

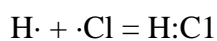

Although chlorine has a greater attraction for electrons than hydrogen, the HCl bond is not the ionic bond. Instead, there is a covalent bond arising from electron sharing of the odd electrons of the two atoms, the $1s$ of the H and the $3p$ of the Cl . The molecule as a whole is electrically neutral, because it contains an equal number of positive and negative charges. However, owing to the unequal sharing of the electron pair, the molecule chlorine end is negative, and the hydrogen end is positive. Because H and Cl are different atoms, the sharing of electrons is unequal. This arises because, the bonding electrons spend more time on the chlorine atom than on the hydrogen atom.

Thus, there is a fundamental difference between a single bond in HCl and a single bond in H_2 or Cl_2 . We usually indicate polarity by using the symbols δ^+ and δ^- , which indicate partial + and - charges. Some polar bonds in common molecules are HF , H_2O , NH_3 .

The electrical charge on a free atom is zero. If the atom is bound to another in a molecule, however, it is impossible to say what its charge may be, since some valence electrons are shared with other atoms. It is possible, though, to define the limiting case to determine at least the sign and maximum value of the charge on an atom involved in a bond. This limiting situation arises if we agree that all the bond pair electrons belong to the more electronegative atom in a bond, which amounts to assuming that all bonds are ionic. The charge on the atom calculated in this «ionic limit» is called the oxidation number.

Here you see that the oxidation number is given by the number of electrons acquired by the atom in excess of its valence electrons (negative oxidation number) or the number released by the atom (positive oxidation number) in the ionic limit.

Molecular Shape. Molecular polarity. Lewis structures only show how many bond pairs and lone pairs surround a given atom. However, all molecules are three dimensional, and most molecules have their atoms in more than one

plane in space. It is often important to know the way molecules fill space, because the structure partly determines the chemical functioning of the molecule. Pharmaceutical companies, for example, use knowledge of molecular shape to design drugs that will fit into the site in the body where pain is to be relieved or disease attacked.

To convey a sense of three dimensionality for a molecule drawn on a piece of flat paper, we use sketches such as a «ball and stick» model of methane, or we can draw structures in perspective using «wedges» for bonds that emerge from or recede into the plane of the drawing. A sampling of perspective sketches and ball-and-stick models of molecules for which we have already drawn Lewis structures is shown below. Although you do not yet know how to predict the structures there is an easy way to do it. Notice how the molecular shape changes with the number of sigma bonds plus lone pairs about the central atom.

Sigma bonds+lone pairs on central atom	Structure of molecule
2	Linear
3	Trigonal planar
4	Tetrahedral (or pyramidal)
5	Trigonal bipyramidal
6	Octahedral

The idea that will allow us to predict the molecular structure is that each lone pair or bond group (sigma + pi pairs) repels all other lone pairs and bond pair groups. Because the pairs try to avoid one another, they move as far apart as possible, and, since all of the pairs are «tied» to the same central atom nucleus, they can only orient themselves so as to make the angles between themselves as large as possible (fig. 2.5).

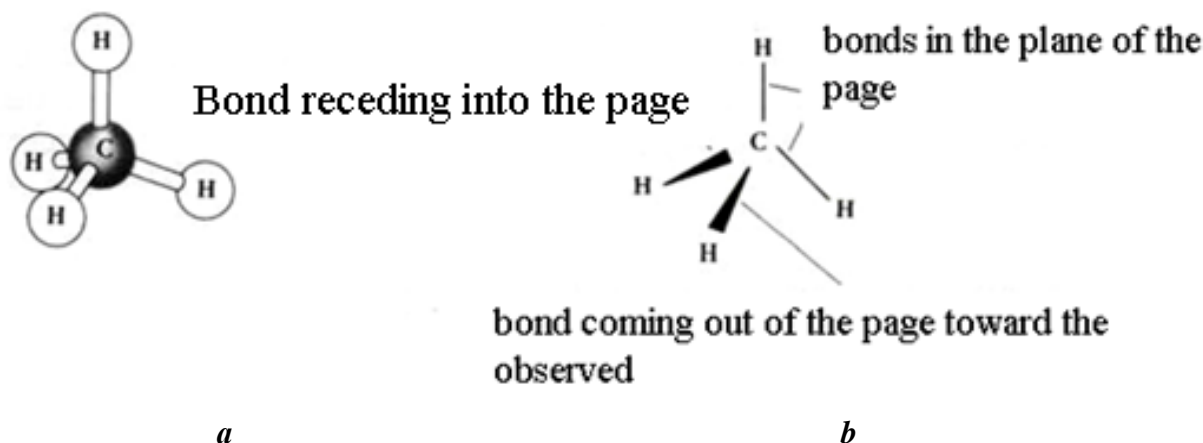

Fig. 2.5. The structure of methane, CH_4 , to show the ways molecular structures will be illustrated:

a — drawing of a ball-and-stick model, *b* — perspective drawing.

The adjective «polar» was used to describe the situation of separated positive and negative charges in a bond. However, because most molecules have at

least some polar bonds, molecules can themselves be polar. In a polar molecule, there is an accumulation of electron density toward one side of the molecule, so that one end of the molecule bears a slight negative charge, δ^- ; the other end has a slight positive charge of equal value, δ^+ . The experimental measure of this separation of charge is the molecule's dipole moment, which is defined as the product of the size of the charge (δ) and the distance of separation. The units of dipole moment are therefore coulomb \cdot meters; a convenient unit is the debye (D), defined as $1 \text{ D} = 3.34 \times 10^{-30} \text{ C} \cdot \text{m}$. Polar molecules will align themselves with an electric field, and they will also align themselves with each other. This interaction of polar molecules is an extraordinarily important effect in water and other substances.

Table 2.1

Perspective Molecular Sketches

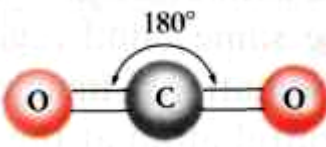
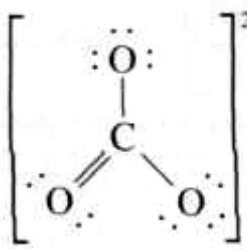
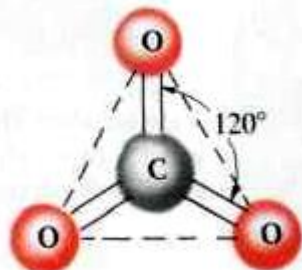
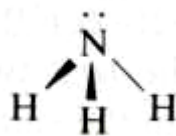
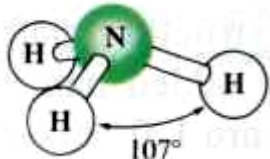
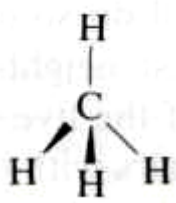
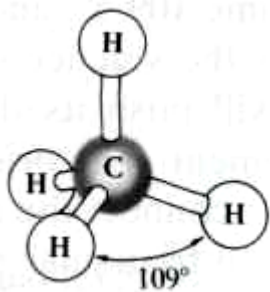
Molecule	Geometry	Perspective sketch	Ball-and-stick model
CO ₂	Linear	O=C=O	
CO ₃ ²⁻	Trigonal planar		
NH ₃	Pyramidal		
CH ₄	Tetrahedral		

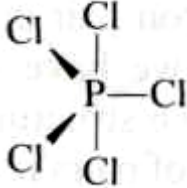
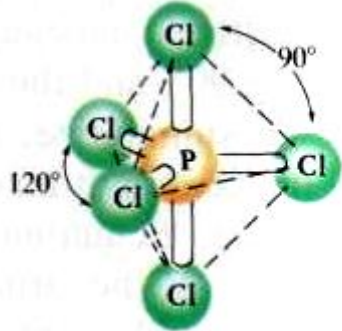
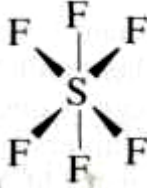
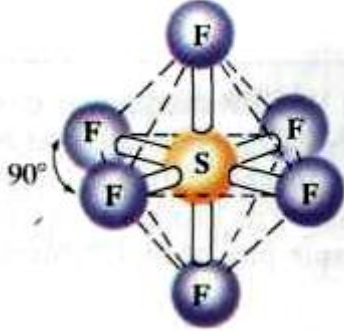
PCl ₅	Trigonal bipyramidal		
SF ₄	Octahedral		

2.5. THEORIES OF CHEMICAL BONDING

There are two commonly used approaches to chemical bonding: the *valence bond (VB) theory* and the *molecular orbital (MO) theory*. The former was first developed by Linus Pauling, while the latter by Robert Mullikan. Mullikan's approach is to combine pure atomic orbitals on each atom to derive *molecular orbitals* that are spread or *delocalized* over the molecule. Only after developing the molecular orbitals are the pairs of electrons of the molecule assigned to these orbitals; thus, the molecular electron pairs are more or less uniformly distributed over the molecule. In contrast, Pauling's approach is more closely tied to Lewis's idea of electron pair bonds, where each electron pair is confined to the space between two bonded atoms and of lone pairs of electrons localized on a particular atom. Only bonding and nonbonding (lone pair) orbitals are considered.

The Valence Bond theory. According to this theory, two atoms form a bond when both of the following conditions occur:

1. There is the *orbital overlap* between the two atoms (fig. 2.6). If two H atoms approach each other closely enough, their 1s orbitals can partially occupy the same region of space.

2. A maximum of two electrons, of the opposite spin, is present in the overlapping orbitals. Due to orbital overlap, the pair of electrons is found within a region influenced by both nuclei. This means that both electrons are mutually attracted to both atomic nuclei, and this, among other factors, leads to bonding.

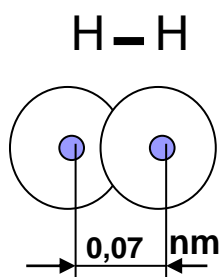

Fig. 2.6. The orbital overlap between the two H atoms

As the extent of overlap between two orbitals increases, the strength of the bond increases. This is seen in fig. 2.7 as a drop in energy as two H atoms, originally far apart, come closer and closer together.

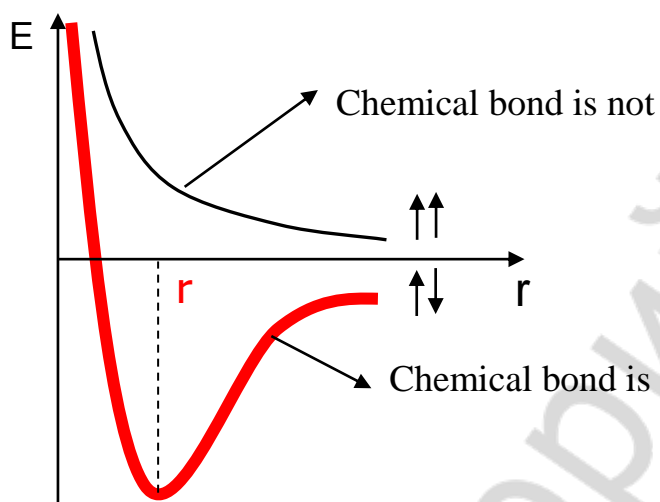

Fig. 2.7. Total potential energy change in the course of H–H bond formation

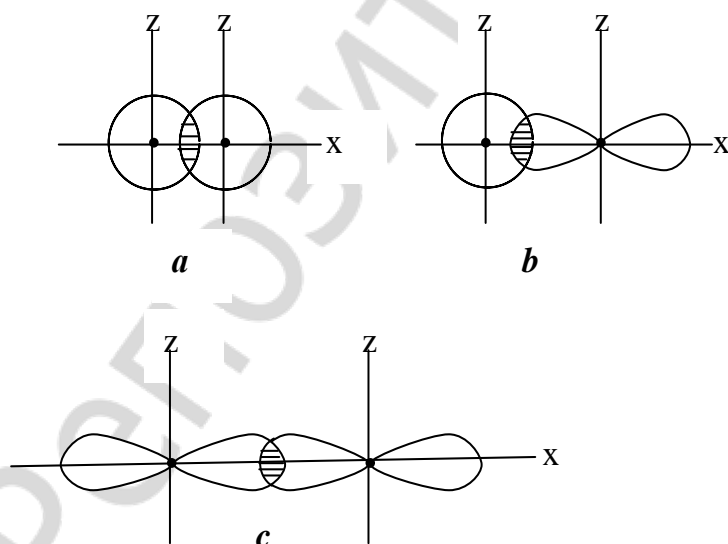

Fig. 2.8. The formation of σ -bond:
a — s — s; *b* — s — p; *c* — p_x — p_x

However, the figure also shows that as the atoms come very close to one another, the energy increases rapidly, due to the repulsion of one positive nucleus by the other. Thus, there is an optimum distance, the observed bond distance, at which the total energy is a minimum; here there is a balance of attractive and repulsive forces.

The overlap of two *s* orbitals, one from each of two atoms leads to a *sigma bond*: the electron density of a sigma bond is the greatest along the axis of the bond (fig. 2.8.). Sigma bonds can also form by the overlap of an *s* orbital with a *p* orbital or by the head-to-head overlap of two *p* orbitals.

Hybrid orbitals. An isolated carbon atom has two unpaired electrons, and so might be expected to form only two bonds.

Carbon Electron Configuration



However, there are four C–H bonds in methane and the geometry of the C atom in CH₄ is tetrahedral. There must be *four equivalent* bonding electron pairs around the C atom. The three *p* orbitals around an isolated atom lie at the angle of 90° to one another. Therefore, if sigma bonds were formed in some manner using pure *s* and *p* orbitals, the bonds would neither be equivalent nor would they be arranged correctly in space. Some other scheme is required to account for C — H bonds at an angle of 109° (table 2.1).

Pauling proposed *orbital hybridization* as a way to explain the formation of bonds by the maximum overlap of atomic orbitals and yet accommodate the use of *s* and *p* orbitals. In order for the four C—H bonds of methane to have their maximum strength, there must be maximum orbital overlap between the carbon orbitals and the H-atom *s* orbitals at the corners of a tetrahedron. Thus, Pauling suggested that the approach of the H atoms to the isolated C atom causes distortion of the four carbon *s* and *p* orbitals. These orbitals *hybridize* or combine in some manner to provide *four equivalent hybrid orbitals that point to the corners of a tetrahedron*.

We label each hybrid orbital as **sp³**, since the orbitals are the result of the combination of one *s* and three *p* orbitals on one atom (fig. 2.9). Each hybrid orbital combines the properties of its *s* and *p* orbital parents.

The theory of orbital hybridization is an attempt to explain how in CH₄ for example, there can be four equivalent bonds directed to the corners of a tetrahedron. Another outcome of hybrid orbital theory is that hybrid orbitals are more extended in space than any of the atomic orbitals from which they are formed. This important observation means that greater overlap can be achieved between C and H in CH₄, for instance, and stronger bonds result than without hybridized orbitals.

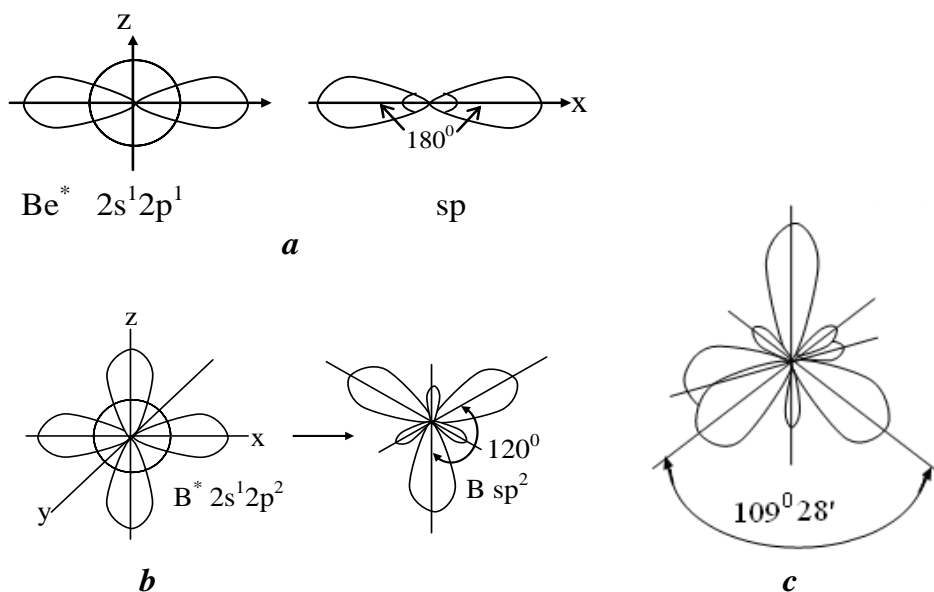
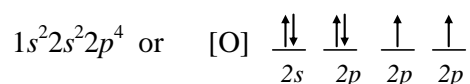

Fig. 2.9. Types of orbital hybridization:
a — sp — hybridization; *b* — sp^2 — hybridization; *c* — sp^3 — hybridization

The four sp^3 hybrid orbitals have the same shape, but they differ in their direction in space. Each also has the same energy, which is the weighted average of the parent s and p orbital energies. Four sigma bonds are to be formed by carbon, so each of the four valence electrons of carbon is assigned, according to Paul's principle and Hund's rule, to a separate hybrid orbital. Overlap of each half-filled sp^3 hybrid orbital with a half-filled hydrogen $1s$ orbital gives *four equivalent C–H bonds arranged tetrahedrally*, as required by experimental evidence.

Hybrid orbitals can also be used to explain bonding and structure for such common molecules as H_2O and NH_3 . An isolated O atom has two unpaired valence electrons as required for two bonds, but these electrons are in orbitals 90° apart.

Oxygen Electron Configuration



However, we know that the water molecule is based on an approximate tetrahedron of structural pairs: the two bond pairs are 105° apart, and the lone pairs occupy the other corners of the tetrahedron (fig. 2.10). If we allow the four s and p orbitals of oxygen to distort or hybridize on approach of the H atoms, four sp^3 hybrid orbitals are created. Two of these orbitals are occupied by unpaired electrons, and lead to the O–H sigma bonds. The other two orbitals contain pairs of electrons and so are the lone pairs of the water molecule.

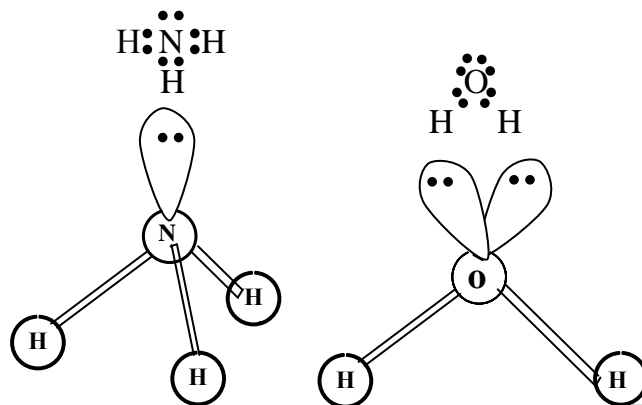

Fig. 2.10. Orbital hybridization in H₂O and NH₃ molecules

Molecular orbital theory. Molecular orbital (MO) theory is an alternative way to view electron orbitals in molecules. In contrast to the localized bond and lone pair orbitals of valence bond theory, pure s and p atomic orbitals of the atoms in the molecule combine to produce orbitals that are spread or delocalized over several atoms or even over the entire molecule. The new orbitals are called *molecular orbitals*, and they can have different energies. Just as with orbitals in atoms, molecular orbitals are assigned to electrons according to the Pauli principle and the Hund's rule.

One reason for learning about the MO concept is that it correctly predicts the electronic structures of certain molecules that do not follow the electron-pairing assumptions of the Lewis approach. The most common example is the O₂ molecule.

The electron dot structure of the molecule as $:\ddot{\text{O}} = \ddot{\text{O}}:$, with all electrons paired. However, experiments clearly show that the O₂ molecule is *paramagnetic* and that it has exactly two unpaired electrons per molecule. It is sufficiently magnetic that solid O₂ clings to the poles of a magnet. The molecular orbital approach can account for the paramagnetism of O₂ more easily than the valence bond theory. To see how MO theory can be applied to O₂ and other small diatomic molecules, we shall first describe *four principles* of the theory.

Principles of molecular orbital theory. The *first principle* of molecular orbital theory is that the number of molecular orbitals produced is *always* equal to the number of atomic orbitals brought by the combining atoms. To see the consequences of this, consider first the H₂ molecule.

Bonding and antibonding molecular orbitals in H₂. When the $1s$ orbitals of two atoms overlap, two molecular orbitals are obtained. The principles of molecular orbital theory tell us that, in one of the resulting molecular orbitals, the $1s$ regions of electron density *add* together to lead to an increased probability that electrons are found in the bond region. Thus, electrons in such an orbital attract both nuclei. Since the atoms are there by bound together, the molecular orbital is called a *bonding molecular orbital*. Moreover, it is a sigma orbital, since the region of electron probability lies directly along the bond axis. We label this molecular orbital σ_{1s} .

Since two combining atomic orbitals *must* produce two molecular orbitals, the other combination is constructed by *subtracting* one orbital from the other. When this happens there is reduced electron probability *between* the nuclei for the molecular orbital. This is called an *antibonding molecular orbital*. Since it is also a sigma orbital, it is labeled σ^*_{1s} , where the asterisk conveys the notion of an antibonding orbital.

A *second principle* of molecular orbital theory is that the bonding molecular orbital is lower in energy than the parent orbitals, and the antibonding orbital is higher in energy (fig. 2.11). The average energy of the molecular orbitals is slightly higher than the average energy of the parent atomic orbitals.

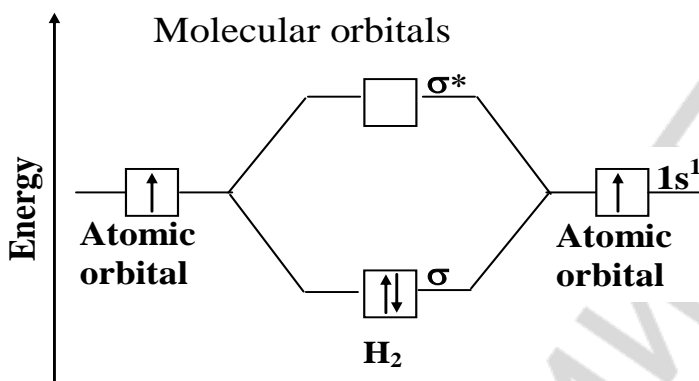

Fig. 2.11. Bonding and antibonding molecular orbitals in H₂

A *third principle* of molecular orbital theory is that the electrons of the molecule are placed in orbitals of successively higher energy; the Pauli principle and the Hund's rule are obeyed. Thus, electrons occupy the lowest energy orbitals available, and they do so with spins paired. Since the energy of the electrons in the bonding orbital of H₂ is lower than that of either parent 1s electron, the H₂ molecule is stable. We write the electron configuration H₂ as $(\sigma_{1s})^2$.

Next consider putting two helium atoms together to form He₂. Since both He atoms have 1s valence orbitals, they combine to produce the same kind of molecular orbitals as in H₂. The four helium electrons are assigned to these orbitals according to the scheme shown in fig. 2.12.

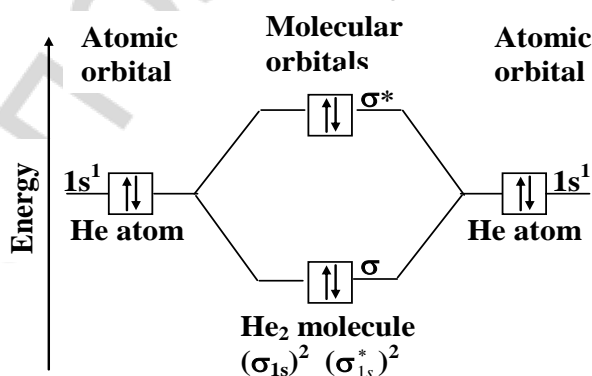

Fig. 2.12. Energy level diagram for the hypothetical He₂ molecule

The pair of electrons in σ_{1s} stabilizes He_2 . However, the two electrons in σ_{1s}^* destabilize the He_2 molecule a little more than the two electrons in σ_{1s} stabilize He_2 . Thus, molecular orbital theory predicts that He_2 has no net stability, and laboratory experiments indeed show that two He atoms have little tendency to combine.

Bond order. Bond order = number of electron pairs in bonding molecular orbitals — number of electron pairs in antibonding molecular orbitals.

In the H_2 molecule, there is one electron pair in a bonding orbital, so H_2 has bond order of 1. In contrast, the effect of the σ_{1s} pair in He_2 is canceled by the effect of the σ_{1s}^* pair, so the bond order is 0. Fractional bond orders are also possible. For example, even though He_2 does not exist, the He_2^+ ion has been detected. Its molecular orbital electron configuration would be $(\sigma_{1s})^2(\sigma_{1s}^*)^1$. Here there is one electron pair in a bonding molecular orbital, but one-half part in an antibonding orbital. Therefore, the net bond order is $\frac{1}{2}$.

Electron configurations for homonuclear, diatomic molecules. Molecular orbital electron configurations are given for the diatomic molecules B_2 through F_2 in table 2.2. We find there is an excellent correlation between the electron configurations and the bond orders, bond lengths, and bond dissociation energies shown at the bottom of the table.

Table 2.2

Molecular Orbital Occupations and Physical Data for Homonuclear, Diatomic Molecules of Second Period Elements

	B_2	C_2	N_2	O_2	F_2
σ_{2p}^*	<input type="checkbox"/>	<input type="checkbox"/>	<input type="checkbox"/>	<input type="checkbox"/>	<input type="checkbox"/>
π_{2p}^*	<input type="checkbox"/> <input type="checkbox"/>	<input type="checkbox"/> <input type="checkbox"/>	<input type="checkbox"/> <input type="checkbox"/>	<input type="checkbox"/> <input type="checkbox"/>	<input type="checkbox"/> <input type="checkbox"/>
σ_{2p}	<input type="checkbox"/>	<input type="checkbox"/>	<input type="checkbox"/>	<input type="checkbox"/>	<input type="checkbox"/>
π_{2p}	<input type="checkbox"/> <input type="checkbox"/>	<input type="checkbox"/> <input type="checkbox"/>	<input type="checkbox"/> <input type="checkbox"/>	<input type="checkbox"/> <input type="checkbox"/>	<input type="checkbox"/> <input type="checkbox"/>
σ_{2x}^*	<input type="checkbox"/>	<input type="checkbox"/>	<input type="checkbox"/>	<input type="checkbox"/>	<input type="checkbox"/>
σ_{2x}	<input type="checkbox"/>	<input type="checkbox"/>	<input type="checkbox"/>	<input type="checkbox"/>	<input type="checkbox"/>
Bond order	One	Two	Three	Two	One
Bond-dissociation energy (kJ/mol)	290	620	941	495	155
Bond distance (pm)	159	131	110	121	143

B_2 and C_2 are not ordinary molecules; C_2 , for example, has been observed only in the vapor phase over solid carbon at high temperatures. It is, however, worth noticing that the higher predicted bond order for C_2 than for

B_2 agrees well with the higher bond dissociation energy and shorter bond length of C_2 .

We know from experiment (and have also predicted from the electron dot structure) that N_2 is a diamagnetic molecule with a short, strong triple bond. The molecular orbital picture is certainly in agreement, predicting a bond order of 3.

The molecular orbital electron configuration for O_2 clearly shows that the bond order is two. Hund's rule requires two unpaired electrons, exactly as determined by experiment. Thus, a simple molecular orbital picture leads to a reasonable view of the bonding in paramagnetic O_2 , a point on which simple valence bond theory failed.

Finally, molecular orbital theory predicts the bond order of F_2 to be one, and the molecule does indeed have the weakest bond of the series in table 2.2.

CHAPTER 3

Chemical Thermodynamics

In the living organisms, the chemical energy is transformed to other forms of energy. Bioenergetics studies the transformation of different kinds of energy in the living organisms. Chemical thermodynamics is the base of bioenergetics.

Thermodynamics is the science about mutual conversions of different kinds of energy and transmission of energy in the form of heat and work .

There are three problems of chemical thermodynamics

1.Determination of the energy effects of the chemical and physico-chemical processes.

2.Determination of the possibility, direction and limits of spontaneous processes under given conditions.

3.Determination of the conditions of equilibrium of the systems.

3.1. TERMINOLOGY OF CHEMICAL THERMODYNAMICS

It is necessary to define precisely certain concepts, terms and quantities used in thermodynamics since any *ambiguity* can lead to wrong conclusions.

A thermodynamic system is a body or group of interacting bodies which we consider apart from its surroundings .For example, a gas in a vessel, a cell ,a plant, an organ, etc .

The following thermodynamic systems are known according to the character of interactions of its surroundings.

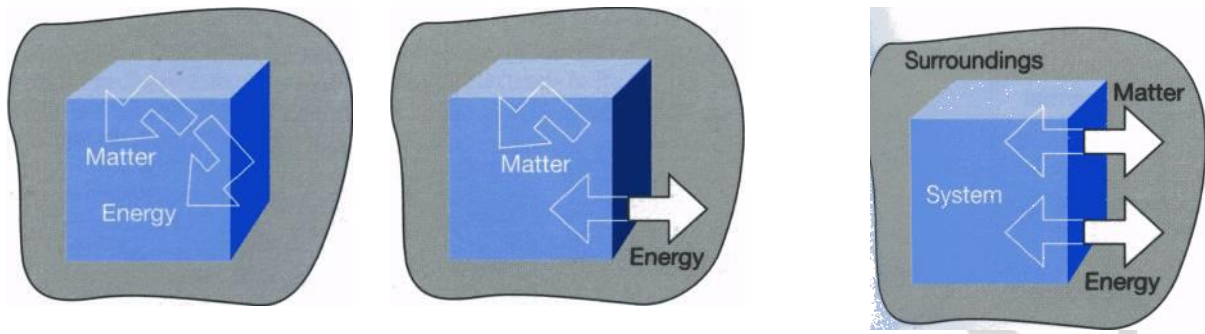

Fig. 3.1. Thermodynamic systems

1. An *isolated system* is one which cannot exchange energy or matter with its surroundings. There are no such systems in the nature.

2. A *closed system* is one which can exchange energy but not a matter with its surroundings. For example an electric lamp.

3. An *opened system* is one which can change energy and matter with its surroundings. For example, a living organism.

A *homogeneous system* is one consisting of a single phase, no any boundary surfaces, all parts of the system have the same physical and chemical properties. For example, the mixture of gases, the solutions.

A *heterogeneous system* is one consisting of several phases, has boundary surfaces and different physical and chemical properties. For example, an ice is in water, liquid and vapour.

A *phase* is the part of the system with the same physical and chemical properties. For example, ice-water (an ice is the first phase, water is the second phase).

The thermodynamic quantities of the state of the system. The thermodynamic quantities characterize the state of the system. The *independent thermodynamic quantities* can be measured. They are: temperature, pressure, mass, volume and density.

Thermodynamic quantities whose value depends only on the state of the system are called *functions of state*. The change of such quantities in a process depends only on the initial and final states of the system, it doesn't depend on the path by which the system is brought from one state to the other. For example, the internal energy depends on temperature, concentration, etc. It is impossible to determine the absolute value of functions of state, because they depend on the other thermodynamic quantities.

The functions of state are: U—the internal energy;

H—the enthalpy;

S—the entropy;

G—the Gibb's free energy.

Thermodynamic processes. Any change in the state of system is the thermodynamic process. Two types of thermodynamic processes are distinguished.

A *reversible thermodynamic process* is defined as a process in which the system *reverts* to its initial state without having caused any changes in its surroundings. If changes do take place in the surroundings, then the process is *irreversible*.

It must be stressed that reversibility and irreversibility, as defined in thermodynamics, do not coincide with the concepts, as applied to chemical reactions in chemistry, where the term «reversible» frequently denotes that a reaction may proceed in either direction, although the return to the initial state leads to changes in the surroundings.

Processes which are carried out at constant temperature are called *isothermal*. ($T = \text{const}$, $\Delta T = 0$)

If a reaction proceeds at constant volume ($V = \text{const}$, $\Delta V = 0$), the process is *isochoric*. Chemical reactions proceed more frequently at constant pressure. The process is *isobaric* ($p = \text{const}$, $\Delta p = 0$).

Adiabatic processes are those in which the system neither absorbs nor gives up heat on its surroundings.

3.2. ENERGY. INTERNAL ENERGY

The quantitative measure of motion of matter is energy. Energy can exist in various forms, all of which are forms of motion of matter. The forms of motion of matter are various and therefore the forms of energy are various as well (mechanical, electric, chemical, etc.) Every form of motion of matter corresponds to its form of energy. The various forms of energy transform into each other. For example, transformation of chemical energy into other forms of energy in a living organism (mechanical, heat energy, electric, etc.).

The joule (J) is a unit of energy. $1\text{J} = 1\text{Nm}$ (Newton-meter). One calorie is equivalent to 4.184 joules.

The internal energy. One of the most important quantities in chemical thermodynamics is the internal energy U of the system. This quantity is a function of state.

The internal energy U of a substance (or system) is the total energy of the particles forming the substance. It consists of the kinetic and potential energies of the particles. The kinetic energy is the energy of translational, vibrational and rotational motion of the particles (atoms, molecules, ions, electrons); the potential energy is due to the forces of attraction and repulsion acting between the particles (intra- and intermolecular interactions):

$$U = E_{\text{kin}} + E_{\text{pot}}$$

The internal energy does not include the kinetic energy of motion of the system as a whole or its potential energy due to position. It is impossible at pre-

sent to determine the absolute value of the internal energy of a system, but changes in internal energy can be determined for various processes, and this is enough for the fruitful application of this concept in thermodynamics:

$$\Delta U = U_2 - U_1,$$

where U_1 and U_2 are the internal energy of the system in the initial (1) and the final (2) state, respectively. The quantity ΔU is considered positive if the internal energy of the system increases as a result of the given process.

The internal energy only depends on the initial and final states of the system; it does not depend on the path by which the system is brought from one state to the other. The internal energy obviously depends both on the amount of the substance and on the environmental conditions. As all other things being the same, the internal energy is directly proportional to the amount of substance.

Energy can be transferred from one part of a system to another in the form of heat or work or simultaneously. *Heat and work are not functions of state, they are forms of energy transfer.*

1. *The heat (Q) is the form of energy transfer which is carried out as disordered motion of matter under the temperature's gradient.*

Such form of energy transfer occurs by the temperature's gradient only. If T_1 is greater than T_2 ($T_1 > T_2$) the energy transfer will take place. The process stops when T_1 equals T_2 (i.e. $T_1 = T_2$).

How does the energy transfer? Look at fig. 3.2.

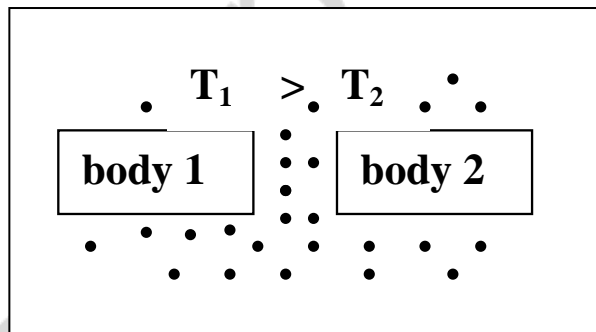

Fig. 3.2. The molecules move disorderly, collide with body 1, gain an excess of energy and then give to another molecules and at last to body 2

2. *Work* is one of the ways of transferring energy from one system (which performs work) to another system (on which work is performed). In the process the internal energy of the first system decreases, while that of the second system increases by an amount corresponding to the work performed (provided no heat has been transferred at the same time) fig.3.3.

The work (A) is the form of energy transfer which is carried out as ordered motion of matter. The work is connected with overcoming the force of friction and the movement of bodies in space.

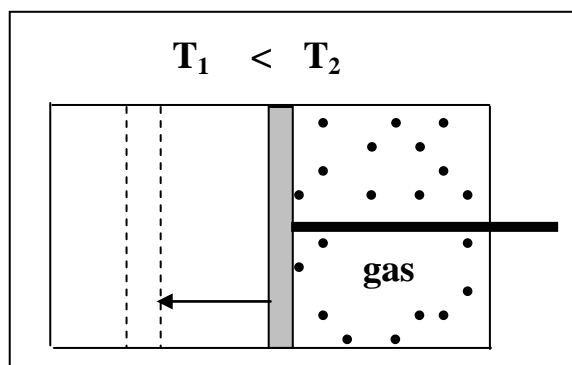

Fig. 3.3. The expansion of a gas makes piston to move

3.3. THE FIRST LAW OF THERMODYNAMICS

The first law of thermodynamics is intimately related to the law of conservation of energy, which establishes the equivalence of the different forms of energy and the relation between the amount of heat absorbed or evolved in a process, the work performed or obtained, and the change in the internal energy of the system.

A number of consequences of this law are of great importance for physical chemistry and for the solution of various technological problems. By means of this law we can perform calculations of the energy balance, and in particular, the heat balance, and the heats of various processes. The first law of thermodynamics is a postulate; it cannot be proven by logical *reasoning*, but follows from the sum total of human experience. Its validity is demonstrated by the complete agreement of all its consequences with experience.

A great part in the formulation of the first law, as we know it today, was played by Hess, Joule and Meyer, Helm Holts and others.

The first law can be formulated in several ways, which are essentially equivalent to one another. One of its forms is as follows.

*The heat energy (**Q**) flowing into a system can be used to change the internal energy of the system (ΔU) and allow the system to perform work (**A**) on its surroundings.* This statement can be written in equation form as $Q = \Delta U + A$, where **A** is the work of expansion.

The following highly useful formulation of the first law is a direct consequence of the proposition that the internal energy of an isolated system is constant «in any process the change in the internal energy of a system $\Delta U = U_2 - U_1$ is equal to the heat **Q** absorbed by the system minus the work **A** done by the system»:

$$\Delta U = Q - A$$

It goes without saying, that all the quantities are to be expressed in the same units. This equation is the mathematical expression of the first law of thermodynamics. By means of it we can define the concept of internal energy thermodynamically as a quantity, the increase in which during a process is equal to the heat absorbed by the system plus the work done on the system by external forces.

The application of the first law of thermodynamics to various processes:

1. *An isochoric process.*

In the course of chemical reactions, work is mainly done against the force of the external pressure. This work depends on the change in the volume of a system. For an isochoric process $V = \text{const}$, $\Delta V = 0$, we have $A = 0$, $A = p\Delta V$, $Q_v = \Delta U + A$ and consequently *the mathematical expression for the first law of thermodynamics at the isochoric process is $Q_v = \Delta U$* , where Q_v is the heat absorbed by the system in conditions of a constant volume.

The heat effect of a reaction at constant volume and temperature corresponds to the change in the internal energy of the system during the reaction. Or: *for a chemical reaction proceeding without a change in the volume of the system, a change in the internal energy equals the heat effect of the reaction taken with the opposite sign.*

The quantity Q_v , like U , is a function of state of a system.

The last equation ($Q = \Delta U$) allows us to determine the change in the internal energy in processes. For instance, when a substance is heated at constant volume, the change in the internal energy is determined from the heat capacity of this substance: $Q_v = \Delta U = nC_v\Delta T$, where C_v is the molar heat capacity of the substance at constant volume, n is the number of moles of the substance, and ΔT is the difference between the final and initial temperatures.

Examples of reactions proceeding at constant volume are reactions in a closed vessel (an *autoclave*), between solids and liquids without the evolution of gases, and between gases if their amount does not change.

2. *An isobaric process.*

For isobaric processes we have $p = \text{const}$ and $\Delta p = 0$, $A = p\Delta V$.

In case of isobaric process $Q_p = \Delta U + p\Delta V$;

$Q_p = U_2 - U_1 + pV_2 - pV_1$, where Q_p is the heat absorbed by the system at constant pressure.

Then we write $Q_p = (U_2 + pV_2) - (U_1 + pV_1)$.

With a view to the sign conventions adopted in thermodynamics, the work is positive if it is done on a system ($\Delta V < 0$) and negative if a system does work against the forces of its surroundings ($\Delta V > 0$).

The function $U + pV$ designated by H is called the enthalpy. The enthalpy, like the internal energy, is a function of state. The enthalpy has the dimension of energy. We obtain $Q_p = H_2 - H_1 = \Delta H$; $Q_p = \Delta H$.

The heat effect of a reaction at constant pressure and temperature corresponds to the change in the enthalpy of the system during the reaction.

The quantity Q_p , like Q_v , is a function of state of a system. *The enthalpy characterizes energy content of the system.*

The enthalpy, like the internal energy, characterizes the energy state of a substance, but includes the energy spent to overcome the external pressure, i.e. to do the work of expansion. Like the internal energy, the enthalpy is determined

by the state of a system and does not depend on how this state was reached. For gases, the difference between ΔU and ΔH in the course of a process may be considerable. For systems containing no gases, the changes in the internal energy and enthalpy attending a process are close to each other. The explanation is that the changes in the volume (ΔV) in processes occurring with substances in condensed (i.e. in the solid or liquid) states are usually very small, and the quantity $p\Delta V$ is small in comparison with ΔH .

The equation $Q_p = \Delta H$ allows us to determine the change in the enthalpy in different processes. Such determinations are similar to those of the internal energy, the only difference being that all the measurements must be conducted in conditions of a constant pressure. Thus, when a substance is heated, the change in its enthalpy is determined from the heat capacity of this substance at constant pressure. $\Delta H = Q_p = nC_p\Delta T$, where n is the number of moles of the substance, and C_p is its molar heat capacity at constant pressure.

3. An isothermal process

$T = \text{const}$ and then $\Delta U = 0$, and $Q_T = A$ i. e. heat transforms into the work of expansion $A = p\Delta V$.

4. An adiabatic process.

An adiabatic process is one in which the system doesn't change heat with its surroundings, the work is performed according decreasing of the internal energy of the system i. e. $Q = 0$, $Q = \Delta U + A$, $A = -\Delta U$.

3.4. THERMOCHEMISTRY

Thermochemistry is the branch of chemical thermodynamics devoted to a quantitative study of the energy effects of chemical and physico-chemical processes.

The heat effect of a reaction is the amount of heat evolved or absorbed in a reaction. Reactions proceeding with the liberation (release) of energy are called *exothermic*, reactions in which energy is absorbed, *endothermic*.

The magnitude of the heat effect depends on the nature of the reactants (initial substances) and the reaction products, their state of aggregation and temperature.

To be able to compare the heat effect of various reactions, one must indicate exactly the conditions under which these reactions occur, and also the physical state of each reaction component. Thermodynamic quantities are generally determined at *standard temperature and pressure (STP)*, namely, at $T = 298\text{K}$ (more exactly, 298.15K) and $p = 101\text{kPa}$ (more exactly, 101.325kPa).

The heat effect of a reaction is measured at a constant temperature (298K) and 101.325kPa (1atm) pressure for the formation of one mole of the product is called the standard heat effect of a reaction.

Heat effect can be included in the equations of reactions. Chemical equations in which the amount of liberated or absorbed heat is indicated are known

as *thermochemical equations*. The physical state of the reactant and products are indicated. The symbols of the elements and the formulas of substances indicate the amount of a substance, therefore the coefficients in thermochemical equations may be either integers or fractions.

There are two forms of writing thermochemical equations. The first form of writing is

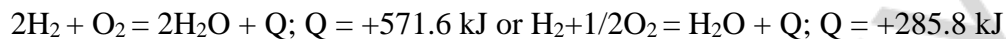

where Q is the thermochemical heat effect of reaction which characterizes the energy change in the surroundings. If energy (E) flows from a system to the surroundings this process is called *exothermic* and $Q > 0$. If energy (E) flows into the system from its surroundings this process is called *endothermic* and $Q < 0$.

Another way to write this equation is $\text{H}_2 + 1/2\text{O}_2 = \text{H}_2\text{O}$; $\Delta H = -286 \text{ kJ/mol}$, where ΔH is the thermodynamic heat effect of the reaction which reflects the energy changes in a reaction system. When $\Delta H < 0$, a reaction is *exothermic* and energy decreases in a system. When $\Delta H > 0$, a reaction is *endothermic* and energy increases in a system. In any case $Q = -\Delta H$.

3.5. HESS'S LAW

The fundamental principle on which all thermochemical calculations are based was established in 1840 by the Russian chemist, academician G.Hess. This principle is known as Hess's law and it is a particular case of the law of energy conservation. It can be formulated as follows:

«The isochoric and isobaric heat effect of a reaction depends only on the initial and final state of substances and does not depend on the intermediate stages of the process».

Hess's law allows us to calculate the heat effects of reactions when for some reason or other they cannot be measured directly. Let us consider as an example of such calculations the determination of the heat of formation of carbon monoxide from graphite and oxygen. It is very difficult to measure the heat effect of the reaction $\text{C}(\text{graphite}) + 1/2\text{O}_2(\text{g}) = \text{CO}(\text{g})$, because upon the combustion of graphite in a limited amount of oxygen, what is obtained, is not only carbon monoxide, but its mixture with carbon dioxide. But the heat of formation of CO can be computed if we know its heat of combustion (283 kJ/mol) and the heat of formation of carbon dioxide (393 kJ/mol).

The combustion of graphite is expressed by the thermochemical equation

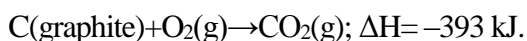

To calculate the heat of formation of CO, we shall write this reaction as two stages and summarize the thermochemical equations corresponding to these stages

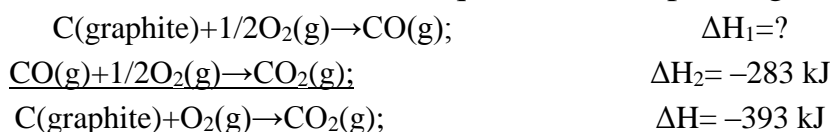

The above transformations can be depicted schematically as follows:

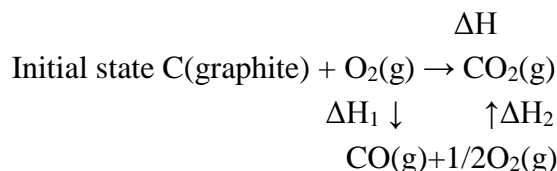

By Hess's law, $\Delta H = \Delta H_1 - \Delta H_2$. This enables us to find the value of ΔH_1 , which doesn't lend itself to experimental measurement, namely,

$$\Delta H_1 = \Delta H - \Delta H_2 = -393 - (-283) = -110 \text{ kJ.}$$

The heat effect of oxidation of glucose in the living organism and in the bomb calorimeter is the same!

The thermodynamical substantiation of Hess's law. Hess's law was established before the first law of thermodynamics. So Hess's law is a corollary of the first law of thermodynamics.

According to the first law of thermodynamics $Q_v = \Delta U$. ΔU doesn't depend on the path by which the system is brought from one state to the other. ΔU is a function of state. In this case Q_v doesn't depend on intermediate stages of proceeding of process as well.

$Q_p = \Delta H$, but ΔH doesn't depend on intermediate stages of proceeding of process, and in this case Q_p doesn't depend on intermediate stages of proceeding either.

$Q_T = A$, but work is not a function of state and it is a function of process.

Hence, Hess's law is strictly valid only for constant-volume processes (the isochoric processes) or for constant-pressure processes (isobaric processes). For these processes it is easily deduced from the first law of thermodynamics.

The corollaries of Hess's law. The physical state in which a pure substance is the most stable at $p=101\text{kPa}$ and a definite temperature (most often 298 K) is assumed to be the standard state of this substance.

The standard enthalpy of formation of substance (ΔH°_f) is defined as the heat of the formation of one mole of a compound from its elements at standard conditions ($T = 298 \text{ K}$, $p = 101 \text{ kPa}$). Standard enthalpies of formation for the elements are defined as zero.

Standard enthalpies of combustion of substance ($\Delta H^\circ_{\text{com}}$) is defined as the heat effect of oxidation of one mole of a compound by oxygen to the higher oxides. Standard enthalpies of combustion of the higher oxides and oxygen are defined as zero.

It follows from Hess's law that:

1. *The enthalpy of formation of substance is equal to the enthalpy of decomposition of substance but opposite in sign, i. e. $\Delta H_f = -\Delta H_{\text{decomp}}$; (Law of Lavoisier and Laplace).*

2. *The heat effect of a reaction equals the sum of the standard enthalpies of formation of the products minus the sum of the standard enthalpies of for-*

mation of the reactants taking into account the proper stoichiometric coefficients.

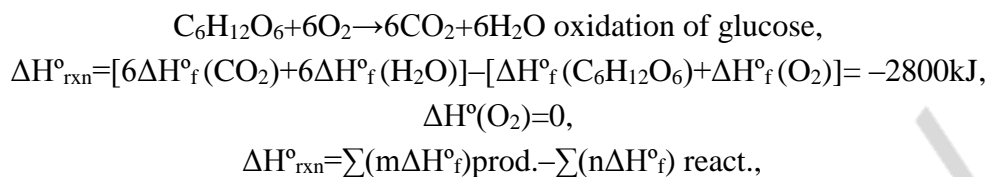

where **m** and **n** are the coefficients in the equation of the reaction.

3. The heat effect of a reaction equals the sum of the standard enthalpies of combustion of the reactants minus the sum of the standard enthalpies of combustion of the products taking into account the stoichiometric coefficients.

$$\Delta H^\circ_{\text{rxn}} = \sum(m\Delta H^\circ_{\text{com}})_{\text{react.}} - \sum(n\Delta H^\circ_{\text{com}})_{\text{prod.}},$$

subscript «rxn» is an abbreviation for «reaction».

3.6. THERMOCHEMICAL CALCULATIONS AND THEIR USING FOR CHARACTERISTICS OF BIOCHEMICAL PROCESSES

The values of the standard enthalpies is in the reference books. These values are used for the calculations.

Example. Calculate the heat effect of the reaction of oxidation of glucose.

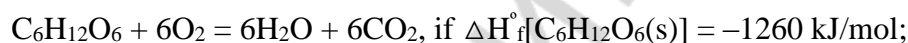

$$\Delta H^\circ_f[\text{CO}_2(\text{g})] = -393.5 \text{ kJ/mol}; \Delta H^\circ_f[\text{H}_2\text{O}(\text{l})] = -285.8 \text{ kJ/mol}.$$

Solution:

$$\begin{aligned} \Delta H^\circ_{\text{rxn}} &= (6\Delta H^\circ_f[\text{H}_2\text{O}(\text{l})] + 6\Delta H^\circ_f[\text{CO}_2(\text{g})]) - \Delta H^\circ_f[\text{C}_6\text{H}_{12}\text{O}_6(\text{s})] = \\ &= [6(-285.8) + 6(-393.5)] - (-1260) = -2815.8 \text{ kJ/mol}. \end{aligned}$$

It is known, the oxidation of one mole of glucose is attended by evolving of 2800kJ of energy in the process of vital activity of organism. The ≈80% of this energy distributes into the surroundings in the form of heat, the ≈20% of this energy is consumed for work (electrical, chemical, etc).

Thermochemistry is a theoretical base for a dietology. The thermochemical properties of foods are discussed in terms of their *specific enthalpy*, the magnitude of the enthalpy of combustion per gram of matter. The specific enthalpy of carbohydrates, which are the main source of energy for a human body, is about 6.7 kJ/g.

Specific enthalpy of lipids is much greater, at around 37.6 kJ/g. Lipids are commonly used as an energy store, to be used only when the more readily accessible carbohydrates have fallen into short supply.

Proteins are also used as a source of energy, but their components, the amino acids, are often too valuable to squander in this way, and are used to contract other proteins instead. When proteins are oxidized to urea, the equivalent specific enthalpy is comparable to that of carbohydrates (16,7 kJ/g).

Various foods have different compositions and hence different energy contents. Many labels on food packages show the calorie content of the food. The calorie (cal) is a non-SI unit of energy where 1 cal = 4.184 J (1 kcal = 4.184 kJ).

Daily Requirements in Energy depend upon muscle activity of a person:

1. Easy muscle work — 2500 kcal,
2. Average muscle work (students, doctors and some others) — 3500 kcal,
3. Hard muscle work — 4500 kcal,
4. Especially hard muscle work (sportsmen) — 7000 kcal.

High muscle activity increases energy requirements by 30–50 %. They are also increased by serious diseases of patients. Thus rheumatoid arthritis gives increase in energy requirements up to 10 %. High mental activity doesn't require increase in energy. Brain constantly oxidizes 5–6 g of glucose.

Table 3.1

Fuel values of food products

Food product	Content, %				Heat content kJ/kt
	Proteins	Lipids	Carbohydrates	H ₂ O	
Bread	6,3	1,3	46,1	43,9	9500
Noodle	11,0	0,9	74,2	13,6	14 980
Suger	—	—	99,9	0,1	17 150
Butter	0,5	83,0	0,5	16,0	32 470
Beaf	18	10,5	—	71,3	7150
Potatoes	2,0	—	21,0	76	3930
Apples	0,4	—	11,3	87	2130

Increase in energy of food products and decrease in physical activity is responsible to obesity. Obesity is a non inflectional Epidemic of the 21 century. 300 millions people suffer from obesity in the world. In high developed countries their number is 30 % of the total population. Obesity increases the risk of heart and oncological diseases, diabetes mellitus.

3.7. THE SECOND LAW OF THERMODYNAMICS

The multitude of different processes which take place in the world about us — in nature, technology, etc. — can be divided in two groups: *spontaneous and non-spontaneous processes*.

1. *The physical and chemical processes that occur without the outside energy are called spontaneous processes.*

Examples of the spontaneous processes are: the fall of a sphere, the mixing of gases, the neutralization of a strong acid by a strong base, any of the reactions occurring during the work of an electrochemical cell, the combustion of fuel, the detonation of an explosive, the rusting of iron, the transformation of a substance from the glassy to the crystalline state, etc.

Majority of the spontaneous processes are exothermic reactions because there is decrease in energy. Examples of the spontaneous exothermic reactions:

a) burning of a substance:

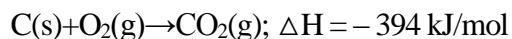

b) neutralization of an acid with a base:

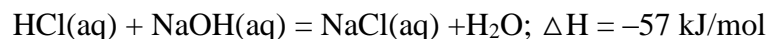

However, many spontaneous reactions may be endothermic. For example, dissolving NH_4NO_3 in water.

2. *The physical and chemical processes that occur with the outside energy are called non-spontaneous processes.*

In non-spontaneous processes work must be done on the system in an amount directly proportional to the change which is brought about.

Examples of non-spontaneous processes are: a separation of a mixture of gases, the motion of a sphere on an inclined plane upwards, the dissociation of water by an electric current, etc.

Changes that are spontaneous in one direction are non-spontaneous in the opposite direction.

The first law, as we have seen, states that the internal energy of an isolated system is constant, and that transformations between different forms of energy take place in equivalent amounts. This can also be expressed in the form of a relation between the change in the internal energy of a system, the amount of heat supplied to it, and the work performed. The first law, however, says nothing about the character, permissibility or direction of the processes by which the various conversions of energy are brought about.

The second law on the other hand, specifies what processes in the system of interest at given temperature, pressure, concentrations, etc., can occur spontaneously (i. e., without work being done on the system), what amount of work can be obtained from such processes, and what is the limit of the spontaneous process, i. e., to what state of equilibrium the system tends under the given conditions.

The second law allows us to indicate the external conditions necessary for the process of interest to proceed in the desired direction and to the required extent. For processes in which work must be done we can determine by means of the second law the amount of work required for the process to be carried out and the dependence of this quantity on the external conditions.

All this is of very great importance both for theoretical investigations in physical chemistry, and for the solution of various practical problems.

The second law of thermodynamics has a more limited field of application than the first law. It is of a statistical nature and is therefore applicable only to systems composed of a large number of particles, i.e. to systems whose behaviour can be described by the laws of statistics.

The changes in energy are not the only criterion for deciding the spontaneity of a reaction. The spontaneous processes lead to an equilibrium in a system

as the final result. The quantitative measure of approach of the system to the equilibrium is *entropy (S)*.

This function is introduced by the second law of thermodynamics.

Entropy is a measure of the degree of disorder of a system. When disorder increases, entropy also increases. The entropy, like the enthalpy and internal energy, is a function of state of a system, hence the change in the entropy ΔS during the transformation of a system is determined only by the initial and final states of the system, its temperature and pressure and does not depend on the path of the process.

For isolated systems, a change in the entropy is a criterion determining the direction of a process. *By the second law of thermodynamics in isolated systems the entropy of a spontaneous process increases, i. e. $\Delta S > 0$.*

In a closed system, the entropy may either increase or decrease during a process. It increases when a system passes from a more ordered state into a less ordered one.

The reverse transition of a system causes its entropy to diminish. *When the entropy is maximum the system is in condition of complete thermodynamic equilibrium ($\Delta S = 0$).*

The processes for which $\Delta S > 0$ include the expansion of gases, phase transitions during which a substance transforms from the solid to the liquid and gaseous states, and the dissolution of crystalline substances. The processes for which $\Delta S < 0$ include the compression of gases and the condensation and crystallization of substances.

Gaseous state is the most disordered and so has the highest entropy. Liquid state is less ordered and so has less entropy than the gaseous state. Solid state is the most ordered and so has the lowest entropy.

$$S(\text{solid}) < S(\text{liquid}) < S(\text{gas}).$$

The second law of thermodynamics will be expressed by the following expressions: $\Delta S > 0$, that S is positive for an irreversible spontaneous change;

$\Delta S = 0$, that S is zero for a reversible change.

In a chemical reaction, the entropy grows if the volume of the system increases. Examples are the reactions:

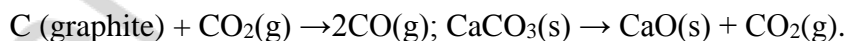

A decrease in the volume in a reaction is attended by a decrease in the entropy, e. g. $2\text{C}(\text{graphite}) + 3\text{H}_2(\text{g}) \rightarrow \text{C}_2\text{H}_6(\text{g})$.

Unlike H and U, we can determine the absolute values of the entropy for all pure substances at any temperatures. By the third law of thermodynamics, the entropy of pure substances existing in the form of perfect crystals is zero at 0K. In other words, at absolute zero, complete order sets in in a perfect crystal.

The *standard entropy* of pure substances is determined for one mole of a substance at $p = 101.325 \text{ kPa}$ and a definite temperature, generally 298 K . It is designated by S^0_{298} or S^0 . The unit of the entropy is $\text{J/mol} \cdot \text{K}$.

The standard entropy of simple substances does not equal zero.

The greater the disorder or randomness in a system, the larger the entropy.

1. The entropy of a substance increases as it changes from solid to liquid to gas:

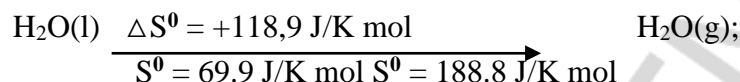

2. When pure solids or liquids dissolve in a solvent, the entropy of the substance increases.

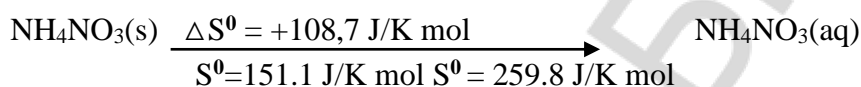

3. When a gas dissolves in a solvent, its entropy declines.

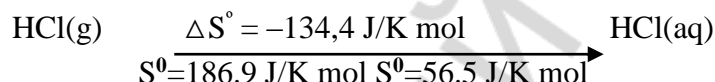

A gas is clearly the most disordered state. When the substance dissolves, there are intermolecular interactions that impose some order, and the entropy declines.

4. Entropy generally increases with increasing molecular complexity.

There are several aspects to the relation between molecular complexity and entropy. For example, the standard entropy increases as the number of ions per formula unit in an ionic solid increases.

	KCl(s)	CaCl ₂ (s)	GaCl ₃ (s)
S ⁰ (J/K mol)	83	115	142

Similarly, entropy increases as the number of atoms increases in a related series of molecules.

In the following series of straight-chain hydrocarbons (all C atoms are bound into a non branching chain), notice that the entropy increases by about 40 J/K mol every time another $-\text{CH}_2-$ group is added to the chain.

		S ⁰ (J/K mol) for gaseous compound
Methane	CH ₄	186.3
Ethane	C ₂ H ₆	229.6
Propane	C ₃ H ₈	269.9
Butane	C ₄ H ₁₀	310.0
Octane	C ₈ H ₁₈	463.6.

A corollary to this is that entropy increases when going from a three-dimensional network solid to one that is only two dimensional. The best examples are of course diamond and graphite, whose very low entropies reflect the high degree of order.

Diamond	2.38
Graphite	5.74
Quarts(SiO ₂)	41.8.

In general, elements that have a high degree of covalent bonding in the solid state (B, C, P, S) have relatively low standard entropies. Metals have values ranging from about 10 J/K mol to 80 J/K mol, while the gaseous elements have the highest values of all.

Since the entropy is a function of state, the change in the entropy ΔS attending a chemical reaction equals the difference between the values of the absolute entropies of the products and reactants at the temperature and pressure of the reaction. For a chemical reaction at standard temperature and pressure (**STP**) we have:

$$\Delta S^0_{\text{rxn}} = \sum m S^0_{\text{prod.}} - \sum n S^0_{\text{react}}$$

where m and n are the number of moles of products or reactants, respectively.

3.8. THE STATISTICAL INTERPRETATION OF ENTROPY

The statistical interpretation of entropy is based on the kinetic theory of gases.

Consider a system containing about five molecules. Every molecule has its own number. Take photograph of this system and have a photo. Then, take another photograph of this system and have another photo, etc. After all we conclude that a macrostate is the state of substance characterized by definite values of its macroscopic properties (temperature, pressure, volume, etc.); a microstate is the state of substance characterized by a definite state of each particle (molecule, atom). The same macrostate corresponds to a great number of various microstates. The number of microstates that form given macrostate is called *the thermodynamic probability* of the given state of the system (**W**)

If $W = 1000$ it means that one macrostate corresponds to 1000 microstates. (The thermodynamic probability should not be confused with mathematical probability which is not greater than one).

There is a relation between entropy and thermodynamical probability of the system (*Boltzmann's equation*):

$$S = k \ln W,$$

where k is a constant in energy or is Boltzmann's constant $k = \frac{R}{N_A}$, where R is the molar gas constant equal to 8.314 J/mol K; N_A is Avogadro's number equal to $6.02 \cdot 10^{23} \text{ mol}^{-1}$. $k = 1,38 \cdot 10^{-23} \text{ J/K}$.

Greater the thermodynamic probability of the given system, greater will be entropy.

3.9. THE THERMODYNAMICAL INTERPRETATION OF ENTROPY

If the statistical interpretation of entropy is given by L. Boltzmann, the thermodynamical interpretation of one is given by Clausius.

We know the entropy of a pure perfectly ordered crystalline substance is zero at the absolute zero of temperature ($S = 0$). In this case one macrostate corresponds to one microstate ($W = 1$), that is $S = 0$ and a system is in equilibrium ($\Delta S = 0$).

With elevation of the temperature the entropy increases, the thermodynamic probability increases but the order decreases in the system. So the entropy of a system depends on quantity of energy (**Q**) put into a system and temperature (**T**) at which the process is carried out. The change in entropy is related to the heat absorbed by the equation:

$$\Delta S_{\text{sys}} \geq Q_{\text{sys}}/T.$$

It is a mathematical expression of the second law of thermodynamics. *For processes with the system at equilibrium:*

$$\Delta S_{\text{sys}} = Q_{\text{sys}}/T \quad (3.1)$$

According to equation $\Delta S_{\text{sys}} = Q_{\text{sys}}/T$ in reversible isothermal processes the entropy change is equal to the heat of the process divided by the absolute temperature.

For a spontaneous process:

$$\Delta S_{\text{sys}} > Q_{\text{sys}}/T \quad (3.2).$$

This equation makes an important distinction between equilibrium and non-equilibrium systems; spontaneously changing systems experience greater disorder (3.2) than they would if the change were made under equilibrium conditions (3.1).

Proteins are formed in the living organisms from amino acids. The process is attended with the decreasing of entropy and consequently the proteins are higher ordered systems.

Synthesis of DNA, RNA proceeds with the decreasing of entropy as well. They are non-spontaneous processes. These processes are needed in energy.

The living organism is an open system which changes energy and matter with its surroundings.

We must consider the living organism as an open system with its surroundings. In this case $\Delta S_{\text{sys}} + \Delta S_{\text{sur}} > 0$. It is impossible to apply the second law of thermodynamics for living organism without biological processes as well.

3.10. THE GIBBS FREE ENERGY

In order to know about direction and limit of the processes in opened and closed systems it is necessary to take account of change in entropy of surroundings. It is very complex and sometimes impossible task.

Besides the change in the enthalpy in the course of a chemical reaction is not a criterion of its direction. Both exothermic and endothermic reactions may proceed spontaneously, although the latter are fewer in number under ordinary conditions.

Consequently the possibility of processes occurring in closed and opened systems at constant temperature and pressure is determined by the change in a thermodynamic function of state called the *Gibbs free energy* ΔG , which is related to the enthalpy and entropy by the equation:

$$G=H-TS, \quad (3.3)$$

where T is the absolute temperature. Synonyms of the Gibbs free energy are the isobaric — isothermal potential, isobaric potential, and the free energy at constant pressure.

The change in the Gibbs energy shows how the direction of a chemical reaction is affected by two competing trends simultaneously acting in a system, namely (3.1) the trend to a minimum energy, and (3.2) the trend to a maximum entropy. At constant temperature and pressure, the change in the Gibbs energy is:

$$\Delta G = \Delta H - T\Delta S \quad (3.4).$$

The notion about the Gibbs energy was introduced on the basis of equations of the first law and second law of thermodynamics.

The equation for the first law of thermodynamics is

$$Q = \Delta U + A \quad (3.5),$$

the equation for the second law of thermodynamics is

$$\Delta S = Q/T, \text{ or } Q = T\Delta S \quad (3.6)$$

Inserting in the expression (3.5) the value $Q = T\Delta S$ from (3.6) we obtain:

$$T\Delta S = \Delta U + A \quad (3.7).$$

The system can perform not only the work of expansion ($p\Delta V$) but perform another forms of work (electric, chemical, osmotic, etc.)

Write the maximum work of process (A_{\max})

$$-A_{\max} = p\Delta V + A_u \quad (3.8),$$

where A_u is the maximum useful work.

Comparing equations (3.7) and (3.8) we obtain

$$\begin{aligned} T\Delta S &= \Delta H + p\Delta V + A_u \\ -A_u &= \Delta U + p\Delta V - T\Delta S \\ -A_u &= U_2 - U_1 + pV_2 - pV_1 - TS_2 + TS_1 \\ -A_u &= \underbrace{(U_2 + pV_2)}_{H_2} - TS_2 - \underbrace{(U_1 + pV_1)}_{H_1} + TS_1 \\ -A_u &= (H_2 - TS_2) - (H_1 - TS_1); H - TS = G \end{aligned} \quad (3.9)$$

$$-A_u = G_2 - G_1 = \Delta G$$

$$-A_u = \Delta G \quad (3.10)$$

In the reversible and isothermal conducting of a process, ΔG is equal in magnitude, but opposite in sign, to the maximum useful work that the system does in the given process.

By useful work is meant all the work done in the course of a process less the work of expansion $p\Delta V$.

It follows from equation $A_u = -\Delta G$ that if a system performs work spontaneously ($A > 0$), then $\Delta G < 0$. In this case a criterion of a spontaneous process is:

$$A > 0 \text{ or } \Delta G < 0.$$

If the system doesn't perform work then $A = 0$ and $\Delta G = 0$. It is a criterion of equilibrium state.

The unit of the Gibbs free energy is J/mol.

The enthalpy and entropy factors and direction of a process

$\Delta G = \Delta H - T\Delta S$. The sign and the magnitude of ΔG are determined by two factors: entropy ($T\Delta S$) and enthalpy (ΔH).

The enthalpy factor defines the tendency of a system to its minimum of energy.

The entropy factor defines the tendency of a system to its disorder.

The Gibbs free energy is an integral function of state of a system.

Depending on the temperature, the influence of one of these factors on the value and sign of ΔG and consequently on the direction of a process may be determining the table 3.2.

Table shows the possibility (or impossibility) of the spontaneous proceeding of a reaction with different combinations of the signs of ΔH and ΔS .

1. If $\Delta H < 0$ for a reaction (an exothermic reaction), and $\Delta S > 0$, it follows from the equation $\Delta G = \Delta H - T\Delta S$ that at all temperatures $\Delta G < 0$. This signifies that the reaction can proceed spontaneously at any temperatures.

The exothermic reactions attended by an increase in the entropy can proceed spontaneously. $\Delta H < 0$, $\Delta S > 0$, $\Delta G < 0$

Table 3.2.

Directions of reactions with different signs of ΔH and ΔS

Sing of change in function			Possibility (impossibility) of spontaneous proceeding of reactions
ΔH	ΔS	ΔG	
-	+	-	Possible at any temperature
+	-	+	Impossible at any temperature
-	-	\pm	Possible at sufficiently low temperature
+	+	\pm	Possible at sufficiently high temperature

2. If $\Delta H > 0$ (endothermic reaction) and $\Delta S < 0$ it follows from the equation $\Delta G = \Delta H - T\Delta S$ that $\Delta G > 0$. *The endothermic reactions attended by a decrease in the entropy and the process can't proceed spontaneously:* (at an ordinary temperature and atmospheric pressure). ($\Delta H > 0$, $\Delta S < 0$, $\Delta G > 0$)

3. If $\Delta H < 0$ and $\Delta S < 0$ or $\Delta H > 0$ and $\Delta S > 0$. In this case value of ΔG depends on absolute values of ΔH and $T\Delta S$: if $|T\Delta S| > |\Delta H|$ then $\Delta G < 0$; if $|T\Delta S| < |\Delta H|$ then $\Delta G > 0$.

If $\Delta H < 0$ and $\Delta S < 0$, the reaction is possible ($\Delta G < 0$) provided that the term ΔH in the equation for the Gibbs energy is greater in magnitude than the term $T\Delta S$; since the magnitude of the term $T\Delta S$ increases with a growth in the factor T , this condition will be observed at sufficiently low temperatures.

In other words, at low temperatures, the spontaneous proceeding of exothermic reactions is most probable even if the entropy of the system diminishes.

At high temperatures, as can be seen from the table, reactions attended by a growth in the entropy are most probable, including endothermic reactions.

We must add that a negative value of ΔG for a reaction points only to the possibility of its occurring. Actually, the reaction may not be observed. The matter is that its rate may be low; hence, notwithstanding observance of the condition $\Delta G < 0$, the reaction will virtually not proceed. In these cases, an appropriate catalyst must be found to increase the rate of the reaction. Such cases are especially frequent at low temperatures.

4. If $\Delta H = T\Delta S$, then $\Delta G = 0$ and the equilibrium sets in (is settled) in the system.

Calculation of ΔG^0 in chemical reactions:

1. The standard free energy of formation ΔG_f^0 is the change of free energy during the formation of a substance in its standard state from the elements in their standard states. The standard free energies of formation of elements in their standard states are zero. The free energy change for a reaction can be found from values of ΔG_f^0 by general equation.

$$\Delta G_{\text{rxn}}^0 = \sum m \Delta G_f^0 \text{ prod.} - \sum n \Delta G_f^0 \text{ react.},$$

where m and n are the numbers of moles of a given product or reactant, respectively.

But the reactions don't proceed at standard conditions (the concentration can not be 1mol/liter).

2. For the reaction $A+B=C+D$ in real conditions calculation of ΔG can be performed according to the equation:

$$\Delta G_{\text{rxn}} = \Delta G^{\circ} + RT \ln [C][D]/[A][B],$$

where $[C]$, $[D]$, $[A]$ and $[B]$ are the concentrations of the substances; ΔG° is the standard change in the Gibbs energy of the reaction, R is the molar gas constant ($R = 8.314 \text{ Jmol/K}$); T is the temperature, K .

3. Alternatively, you can calculate the enthalpy and entropy changes for the reaction $\Delta H^{\circ}_{\text{rxn}}$ and $\Delta S^{\circ}_{\text{rxn}}$ and combine them using the Gibbs equation:

$$\begin{aligned}\Delta G^{\circ}_{\text{rxn}} &= \Delta H^{\circ}_{\text{rxn}} - T\Delta S^{\circ}_{\text{rxn}} \\ \Delta H^{\circ}_{\text{rxn}} &= \sum \Delta H^{\circ}_{\text{prod.}} - \sum \Delta H^{\circ}_{\text{react.}} \\ \Delta S^{\circ}_{\text{rxn}} &= \sum S^{\circ}_{\text{prod.}} - \sum S^{\circ}_{\text{react.}}\end{aligned}$$

a) $\Delta G^{\circ} < 0$ (is less than zero), a process is spontaneous at standard conditions;

b) $\Delta G^{\circ} > 0$ (is greater than zero), a process is not spontaneous at standard conditions;

c) $\Delta G^{\circ} = 0$, the process is at equilibrium.

3.11. BIOENERGETICS. ENDERGONIC AND EXERGONIC REACTIONS

Bioenergetics is thermodynamics of biological systems. It deals with the energy, heat and work exchange in plants, animals and human bodies. A human body is an open stationary system. Its main source of energy is chemical energy of food products (99 %). Carbohydrates are responsible for 55–60%, lipids — 20–25 %, and proteins — 15–20 %.

In general efficiency of food chemical energy conversion in a human body is approximately 20–25 %. Thus waste energy dissipated into surroundings is 75–80 %. 20 liters of water can be boiled if focused daily waste energy of one person. Biochemical reactions are chemical reactions which proceed in vivo. They are:

Exergonic (spontaneous) $\Delta G < 0$;

Endergonic (nonspontaneous) $\Delta G > 0$.

Many biochemical reactions are endergonic, but in some cases they can be carried out to an appreciable extent by coupling them with an exergonic reaction.

A coupled (conjugated) reaction is a process in which an endergonic reaction is made to proceed by coupling it to an exergonic reaction. Biologically coupled reactions are usually mediated with the aid of enzymes. A scheme of a coupled reaction can be represented as follows:

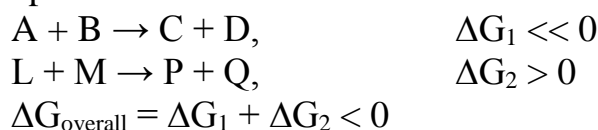

Carbohydrates and lipids metabolism involves highly spontaneous oxidation reactions:

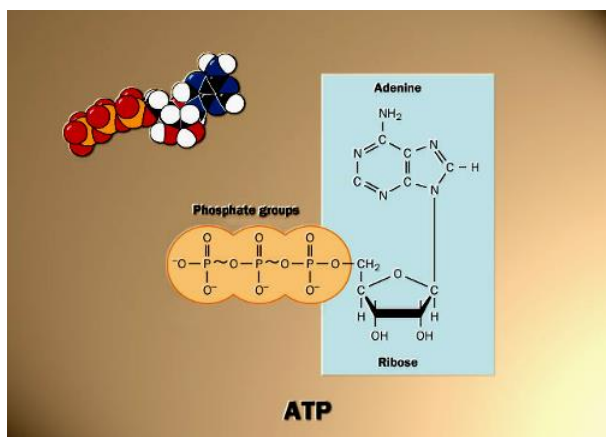
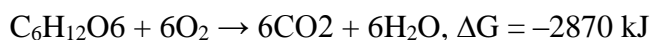
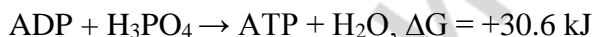

Fig. 3.4. The structure of ATP

Some of this energy is released as heat that maintains constant body temperature. Another portion is stored in high-energy molecules that a body uses as «power sources» for numerous reactions that occur within cells. The most important of these energy transport molecules is adenosine triphosphate (ATP) (fig.3.4).

Adenosine triphosphate (ATP) is a high-energy triphosphate ester used in living systems to provide chemical energy for metabolic needs.

Synthesis of ATP molecules from ADP and phosphoric acid is nonspontaneous under physiological conditions:



In cells ATP production is coupled with glucose oxidation. One molecule of glucose can convert as many as 36 ADP molecules into ATP molecules as it is oxidized to CO_2 and water:

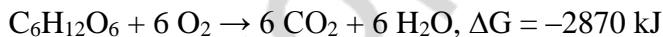

$$\Delta G_{\text{overall}} = -2870 + 1100 = -1770 \text{ kJ}$$

Although 1100 kJ of energy is stored in this coupled process, 1770 kJ of energy is “wasted”. Efficiency of a process is: $1100/2870 = 0.38$ or 38%

Thus cells harness 38% of the chemical energy stored in glucose to drive the biochemical machinery of metabolism. The remaining 62% of energy is dissipated as heat.

3.12. THERMODYNAMICS OF THE CHEMICAL EQUILIBRIUM

All chemical reactions can be divided into two groups: *irreversible* and *reversible* reactions. *Irreversible reactions proceed to the end* — until one of the reactants is completely used up. Irreversible reactions are characterized by the formation of an insoluble substance, the formation of a gas, the formation of a weak electrolyte (H_2O).

A reversible reaction is the reaction which can proceed either in the forward or in the reverse direction. Reversible reactions are characterized by the symbol \rightleftharpoons between the reactants and products. When the rates of the forward

(V_f) and reverse (V_r) reactions become the same, *chemical equilibrium sets in*, i. e. $V_f = V_r$. As soon as equilibrium has been reached, the concentrations of the substances (both the reactants and the products) remain unchanged provided the conditions are not altered. These concentrations are called *equilibrium concentrations*.

Chemical equilibrium is characterized quantitatively by a quantity known as the chemical equilibrium constant. *The chemical equilibrium constant is the ratio of the product of product equilibrium concentrations to the product of reactant equilibrium concentrations*. For example, for the reaction $aA + bB \rightleftharpoons cC + dD$ the chemical equilibrium constant is:

$$K = \frac{[C]^c [D]^d}{[A]^a [B]^b}$$

Concentrations of solids are assumed to be 1 and they can be left out of the concentration ratio without altering the value of K.

The numerical value of the equilibrium constant in the first approximation characterizes the yield of the given reaction (the yield of a reaction is defined as the ratio of the amount of a substance produced to its amount that would have been produced if the reaction proceeded to the end). For example, *when $K \gg 1$, the yield of a reaction is high*, because $[C]^c [D]^d \gg [A]^a [B]^b$ i.e. at equilibrium, the concentrations of the products are much greater than those of the reactants, and this is exactly what signifies that the yield of the reaction is high. *When $K \ll 1$ the yield of the reaction is low.*

The magnitude of the equilibrium constant depends on the nature of the reacting substances and on the temperature. It does not depend on the presence of catalysts. A catalyst does not affect the magnitude of the equilibrium constant and, consequently, cannot either increase or lower the yield of the reaction. It can only accelerate or retard the setting in of equilibrium.

The equilibrium constant determines the extent of a process by the instant of reaching the equilibrium state. The larger this quantity, the greater is the degree of conversion of the reactants into the products.

The ways of designation of the equilibrium constant:

1. *For solutions of non-electrolytes and sufficiently dilute solutions of electrolytes* the equilibrium constant K_c is used (the equilibrium concentrations are expressed in mol/liter in liquid phase):

$$K_c = \frac{[C]^c [D]^d}{[A]^a [B]^b}$$

2. *For strong electrolytes* the activity (a) is used:

$$K_a = \frac{a^c(C) \cdot a^d(D)}{a^a(A) \cdot a^b(B)}$$

3. *Chemical equilibrium between gases* at low pressures is expressed in terms of the partial pressures p_i of the reactants and products:

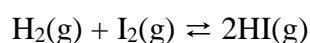

$$K_p = \frac{p^2(\text{HI})}{p(\text{H}_2) \cdot p(\text{I}_2)}$$

A relationship between K_c and K_p is given by an equation:

$$K_c = K_p \cdot RT^{(a+b-c-d)}$$

3.13. THE EQUATION OF THE ISOTHERM OF A CHEMICAL REACTION

$A + B \rightleftharpoons C + D$. The reaction takes place at constant temperature and constant pressure.

The change in the Gibbs energy of this reaction in real conditions is

$$\Delta G = \Delta G^\circ + RT \ln \frac{[C][D]}{[A][B]} \quad (3.11)$$

The value of the change in the Gibbs energy in a reaction depends on the temperature and also on the nature and concentrations of the reactants and products.

For the state of chemical equilibrium $\Delta G=0$, then we obtain from (3.11)

$$0 = \Delta G^\circ + RT \ln \frac{[C][D]}{[A][B]}, \text{ but } \ln \frac{[C][D]}{[A][B]} = \ln K_c \text{ and } \Delta G^\circ = -RT \ln K_c \quad (3.12)$$

We can write this equation (3.12) as $\ln K_c = -\Delta G^\circ/RT$ or in exponential form

$$K_c = e^{-\Delta G^\circ / RT} \quad (3.13),$$

where e is the base of natural logarithms ($e = 2.718\dots$).

From equation (3.13) we can deduce, that K_c depends on the temperature and the nature of the reactants (entropy and enthalpy factors).

With elevation of the temperature the equilibrium constant increases too.

The $\ln K_c$ determines the extent of a proceeding of a reaction.

K_c is the equilibrium constant expressed in terms of concentrations of the components A, B, C, and D in equilibrium.

If we introduce the value 2.303 (the number 2.303 is coefficient of transition from natural logarithm to common one) and the value of the molar gas constant $R=8.31 \text{ J/mol K}$ into the above equation (3.12), we get

$$\Delta G^\circ = -2.303 \cdot 8.31 \cdot T \log K_c = -19.1 \log K_c \text{ (J/mol)}$$

$$\text{or } \Delta G^\circ = -0.0119 \cdot T \log K_c \text{ (kJ/mol)}$$

Introduce the equation (3.12) into the equation (3.11), we get

$$\Delta G = -RT \ln K_c + RT \ln \frac{[C][D]}{[A][B]} \quad (3.14),$$

where $[A], [B], [C], [D]$ are not equilibrium concentrations. It is the equation of the isotherm of a chemical reaction, where $\ln \frac{[C][D]}{[A][B]}$ is the concentration term; $\ln K_c$ is the constant term.

The sign of ΔG depends on the real concentrations of the reactants and products for given time (for a moment).

The analysis of the equation (3.14):

1. $\ln \frac{[C][D]}{[A][B]} < \ln K_c$ and $\Delta G < 0$

A spontaneous chemical reaction occurs from left to right. If we change the concentrations we can affect the direction of the spontaneous proceeding of the reaction.

2. $\ln \frac{[C][D]}{[A][B]} < \ln K_c$ and $\Delta G > 0$

A spontaneous chemical reaction doesn't occur from left to right, but the reaction is spontaneous from right to left.

3. $\ln \frac{[C][D]}{[A][B]} = \ln K_c$ and $\Delta G = 0$

The system is in an equilibrium.

The equation $\Delta G^\circ = -19,1 \lg K_c$ makes it possible to calculate the equilibrium constant, if we know ΔG° and, conversely, to determine ΔG° for a reaction using the experimentally found value of the equilibrium constant. It must be stressed in this connection that the sign of ΔG° indicates the possibility or impossibility of a reaction proceeding only in standard conditions, when all the reactants and products are in standard states.

In the general case, however, the possibility (or impossibility) of a reaction is determined by the sign of ΔG , and not of ΔG° .

The equilibrium constant's dependence on the enthalpy and entropy factors indicates that it also depends on the nature of the reactants.

3.14. THE EQUATION OF THE ISOBAR OF A CHEMICAL REACTION

$p = \text{const}$, in the integral form we have the equation:

$$\ln \frac{K_1}{K_2} = \frac{\Delta H}{R} \left(\frac{1}{T_1} - \frac{1}{T_2} \right) \quad (3.15)$$

where K_1 and K_2 are equilibrium constants at the different temperatures T_1 and T_2 ; ΔH is change in enthalpy; R is the molar gas constant.

This equation relates the equilibrium constant, the enthalpy change and the temperature, i.e. it relates the kinetics and thermodynamics.

The equation is in the differential form $\frac{d \ln K_p}{dT} = \frac{\Delta H}{RT^2}$ (3.16)

These equations (3.15 and 3.16) establish a relation between the change in the equilibrium constant with temperature and the heat of the reaction. They are valid for processes which take place at constant pressure, and are called *the equations of the reaction isobar*.

For constant-volume processes a similar equation can be obtained:

$$\frac{d \ln K_c}{dT} = \frac{\Delta U}{RT^2} \quad (3.17),$$

This equation relates the change in the equilibrium constant with temperature to the heat of the reaction and is called *the equation of the reaction isochore*. ΔU is the change in internal energy.

The analysis of the equation of the Isobar of a chemical reaction (3.16):

1. $\Delta H < 0$ *exothermic reaction*.

When heat is evolved in the chemical reaction i. e. $\Delta H < 0$ and $\frac{\Delta H}{RT^2} < 0$ as well, then from equation (3.16) we conclude that $\frac{d \ln K_p}{dT} < 0$. This denotes that the equilibrium constant decreases with rise in temperature (the numerator decreases) and equilibrium is displaced towards the left. In other words, with rise in temperature equilibrium is displaced in the direction of the endothermic process.

With lowering in temperature the equilibrium constant increases ($dT < 0$) and equilibrium is displaced towards the right.

2. $\Delta H > 0$ *endothermic reaction*.

When heat is absorbed in the chemical reaction, i. e. $\Delta H > 0$ and $\frac{\Delta H}{RT^2} > 0$ as well, then from equation (3.16) we conclude that $\frac{d \ln K_p}{dT} > 0$. This denotes that the equilibrium constant increases with rise in temperature and with lowering in temperature the equilibrium constant decreases.

The equations (3.16) and (3.17) of the reaction isobar and isochore describe the change in the equilibrium constant with temperature. They express this dependence in differential form. For practical computations of equilibrium at different temperatures it is usually necessary to integrate these expressions.

3.15. LE CHATELIER PRINCIPLE

A change in the conditions (temperature, pressure, concentration) under which a system is in a state of chemical equilibrium disturbs equilibrium because of the different changes in the rates of the forward and reverse reactions ($V_f \neq V_r$). With time, new chemical equilibrium sets in in the system ($V_f = V_r$) that corresponds to the new conditions. The transition from one equilibrium state to another is called a *shift of equilibrium*.

The direction of a shift of chemical equilibrium as a result of a change in the external conditions is determined by *Le Chatelier's principle*: «if any change of conditions is imposed on a system in equilibrium, equilibrium will shift in the direction of the process that counteracts the imposed change».

For instance, *elevation of the temperature* leads to the shifting of equilibrium in the direction of the reaction attended by the absorption of heat, i. e. by cooling of the system;

an increase in the pressure causes equilibrium shift in the direction of a decrease in the total number of moles of gaseous substances, i.e. in the direction leading to lowering of the pressure;

the removal from a system of one of the products results in equilibrium being displaced in the direction of the forward reaction;

diminishing of the concentration of one of the reactants leads to shifting of equilibrium in the direction of the reverse reaction.

CHAPTER 4 Chemical Kinetics

Chemical kinetics is the science about rates and mechanisms of chemical reactions. Tasks of chemical kinetics:

1. The establishment of factors affecting rates of chemical reactions.
2. The establishment of mechanism of chemical reactions.

4.1. BASIC CONCEPTS OF CHEMICAL KINETICS, SIMPLE AND COMPLEX REACTIONS

Simple reactions have one step and their stoichiometric equations exactly express the real process.

For example: $\text{H}_2 + \text{I}_2 = 2\text{HI}$

Complex reactions have several steps and their stoichiometric equations don't express the real process which consists from several steps.

For example: $\text{H}_2\text{O}_2 + 2\text{HI} = \text{I}_2 + 2\text{H}_2\text{O}$

The first step $\text{H}_2\text{O}_2 + \text{HI} = \text{HOI} + \text{H}_2\text{O}$

The second step $\text{HOI} + \text{HI} = \text{I}_2 + \text{H}_2\text{O}$
 $\text{H}_2\text{O}_2 + 2\text{HI} = \text{I}_2 + 2\text{H}_2\text{O}$

Most reactions are complex. The mechanism of every chemical reaction is determined by the sum of steps. Every individual step of mechanism of chemical reaction is called a simple reaction.

Homogeneous and heterogeneous reactions. Homogeneous reaction refers to reaction occurring amongst species present in the same phase, or in liquid and gaseous solutions.

For example: $\text{N}_2 + \text{O}_2 \xrightarrow{t} 2\text{NO}$

$2\text{SO}_2 + \text{O}_2 \rightarrow 2\text{SO}_3$

When different phases occur, for example between two immiscible liquids or a solid and a liquid, the reaction is referred to as heterogeneous. The reaction can occur only at the surface of contact of the two phases:

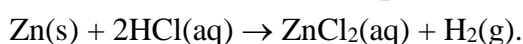

4.2. RATES OF REACTIONS

Chemical reactions proceed at different rates. The reaction of neutralization between aqueous acids and bases occurs almost instantaneously, while the rusting of iron is slow.

The rates of chemical processes in vivo differ greatly. The time of the total renewal of bone tissue is 4–7 years, the time of a half proteins renewal — 70 days, chemical reactions responsible for neural activity run instantly.

The rate of chemical reaction is a basic concept in chemical kinetics.

The rate of a reaction can be measured by the change of molar concentration of one of the reactants or products per unit time .

The rate of chemical reaction can be calculated from the formula

$$v = \frac{\Delta C}{\Delta t} ,$$

where ΔC is the change of concentration in mole /liter; Δt is the change of time in sec., min., hour.

$$[V] = \left[\frac{\text{mol}}{\text{liter} \cdot \text{sec.}} \right] \text{ or } \left[\frac{\text{mol}}{\text{liter} \cdot \text{min}} \right] .$$

This is an average rate of chemical reaction, i.e. the rate in the period of time from t_0 till t . The average rate is designated as \bar{v} . In practice the instantaneous rate is used. The instantaneous rate is the rate at the given moment of time (R).

The smaller the period of time Δt the nearer the average rate (\bar{v}) to the instantaneous rate (R), i.e. the average rate \bar{v} in the period of time from t_0 till t aspires to the instantaneous rate of chemical reaction provided t leads to t_0 (provided $t \rightarrow t_0$) or mathematically:

$$R = \lim_{t \rightarrow t_0} \bar{v} = \lim_{t \rightarrow t_0} \left(\frac{\Delta C}{\Delta t} \right)$$

The instantaneous rate i.e. the rate at instant t_0 will be the limit of the average rate $\frac{\Delta C}{\Delta t}$ as t tends towards t_0 .

The ratio $\frac{\Delta C}{\Delta t}$ can go on to the infinitesimals and give derivative $\frac{dC}{dt}$, i. e. $R = \pm \frac{dC}{dt}$.

In the way the derivative from concentration (C) to time (t) characterizes the instantaneous rate (real rate) of chemical reaction.

Measurement of rate of a chemical reaction. Rate of reaction is always to be determined experimentally and cannot be predicted theoretically.

1. Direct methods.

The concentration of reactants or products is determined depending on time. By plotting C against t a graph of the type shown in the fig. 4.1, 4.2 is obtained. This graphs are called a Rate Curve.

Knowing the Rate Curve for any substance it is easy to calculate the rate of decomposition or formation of the substance by measuring slope as shown in fig. 4.1, 4.2. The slope of the Rate Curve characterizes the real rate at the given moment, i. e. the tangent α of slope numerically equals the real rate. Mathematically: $\text{tg}\alpha \approx \frac{\Delta C}{\Delta t} \approx \bar{v}$ (average rate). Tangent of α approximately equals the ratio of ΔC to Δt and equals the average rate, or in differential form: $\text{tg}\alpha = \frac{dC}{dt} = R$, α is the angle of slope of Rate Curve.

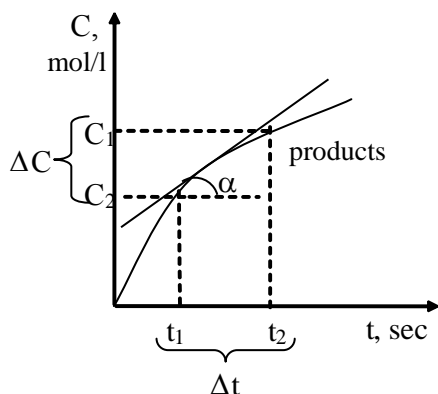

Fig. 4.1. The concentration increases

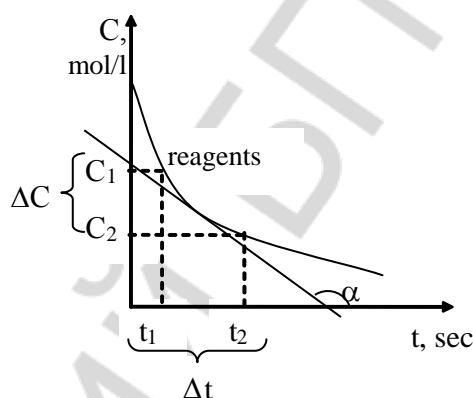

Fig. 4.2. The concentration decreases

2. Indirect methods.

During a chemical reaction the concentrations of the reactants present change with time, and hence the properties of the reaction mixture are apt to change. The rate of the reaction is determined by measuring a changing property, such as intensity of colour, partial pressure of one component, refractive index, pH (negative common logarithm of H^+ concentrations), conductivity et al.

4.3. FACTORS INFLUENCING THE RATE OF A REACTION

Experimentally, the reaction rate is found to be affected by the following factors:

1. Nature of reactants

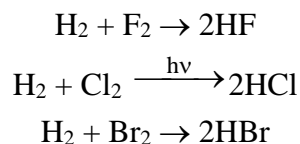

2. Effect of temperature

3. Effect of concentration

Experiment shows that the rate of a given reaction may be increasing the concentration of one or of all the reactants.

E. g. a very dilute aqueous hydrochloric acid solution reacts with zinc more slowly than a more concentrated solution of the acid. However, the quantitative influence of the concentration and how the reaction rate changes can be found only by experiment.

4. *Effect of pressure (gaseous systems)*

5. *The form of vessel*

6. *Catalysts*

The effect of concentration on the rate of chemical reaction. The effect of concentration on the rate of chemical reaction is expressed by basic postulate of chemical kinetics.

The rate of a chemical reaction (instantaneous) at a constant temperature is directly proportional to the product of the concentrations of the reactants to powers is expressed with small numbers.

Thus, for the reaction $mA + nB \rightleftharpoons C + D$ we have $V = k[A]^m[B]^n$, where V is the rate; k is the rate constant; and $[A]$ and $[B]$ are the concentrations of the reactants A and B ; m , n are small numbers. The equation reflecting the function connection between the rate of the reaction and concentration of the reactants is called kinetic equation where k is the rate constant:

$$V = \pm \frac{dC}{dt} = k[A]^m[B]^n,$$

Concentrations of solids are assumed to be 1 (constant) and they can be left out of kinetic equation.

Physical sense of k :

k is a such rate of the reaction when concentration of the reactants equal 1 mol/liter or product of this concentrations equal one, i. e. $\frac{dC}{dt} = k$ at $[A] = [B] = 1$ mol/liter.

Sometimes k is called the specific rate.

Chemical sense of k : the rate constant of the chemical reaction is quantitative measure of reaction ability of molecules.

The more k the more rate of the reaction.

The rate constant doesn't depend on concentration of the reactants but depends on temperature.

Write equation: $V = k[A]^m[B]^n$, where m is the order with respect to reactant A , while n is the order with respect to reactant B . The sum ($m + n$) is called the common (total) order of the reaction.

The order of the reaction is the formal magnitude and depends upon the concentration, the temperature, the catalyst. The order of the reaction can be positive, negative, whole or fractional numbers, nought.

The order of the reaction is determined by experimentally and it is not necessarily related to the equation written for the reaction. The order of the reaction cannot be predicted before.

Consider the balanced reaction between A and B to give C and D:

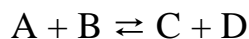

Assume that the reaction takes place in a container with a constant volume and of a constant temperature.

Take the substance A in excess and its concentration remains constant. Then we study the rate of the reaction to reactant B, changing its concentration.

$[B] \rightarrow V$ Then the order of the reaction

$2[B] \rightarrow 4V$ with respect to reactant B

$3[B] \rightarrow 9V$ is n, id est $2n = 2$

If we take the substance B in excess its concentration remains constant. Then we study the rate of the reaction to reactant A, changing its concentration.

$[A] \rightarrow V$ Then the order of the reaction

$2[A] \rightarrow 2V$ with respect to reactant A

$3[A] \rightarrow 3V$ is m, id est $m = 1$

4.4. CLASSIFICATION OF THE REACTIONS IN ORDER

1. Zero order reactions

Here the rate doesn't depend on the concentration. The rate is constant.

Kinetic equation is: $V = -\frac{dC}{dt} = k_0$,

where k_0 is the rate constant, the units of k_0 are: $[k_0] = [C][t^{-1}] = [\text{mol} \cdot \text{liter}^{-1} \cdot \text{sec}^{-1}]$, where C is concentration in mol/liter, t is time in seconds.

Examples:

a) Photochemical reactions: $\text{H}_2 + \text{Cl}_2 \xrightarrow{h\nu} 2\text{HCl}$

The rate of the reaction depends upon quantum's of light

b) Hydrolysis of an ester:

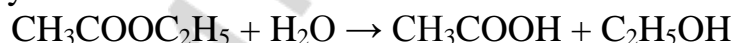

The ester is taken in excess and its concentration will be constant because expense of the ester is constantly filled in from the ester layer. In this way the concentration of the aqueous layer will remain constant and the rate will not vary, $V = \text{const}$.

c) Decomposition of some compounds on the surface of different substances when the rate of decay doesn't depend on its concentration in volume.

2. First order Reactions.

Here the rate depends on the concentration. Kinetic equation is

$V = -\frac{dC}{dt} = k_1C$, where k_1 is the rate constant. The unit of k_1 is sec^{-1} . $[k_1] = [\text{sec}^{-1}]$.

On separating the variables in equation $-\frac{dC}{dt} = k_1C$; $-\frac{dC}{C} = k_1dt$ and integrating, we obtain $\ln C = -k_1t + \text{const}_1$. Designating the initial concentration (of $t=0$) by C_0 , we determine the constant of integration $\text{const}_1 = \ln C_0$, whence

$$\ln C = -k_1 t + \ln C_0 \Rightarrow \ln C - \ln C_0 = -k_1 t \Rightarrow \ln \frac{C}{C_0} = -k_1 t; k_1 = \frac{1}{t} \ln \frac{C_0}{C}$$

or in common logarithm $k_1 = \frac{2,303}{t} \lg \frac{C_0}{C}$, where t is time; C_0 is the initial concentration; C is the concentration at t .

Examples:

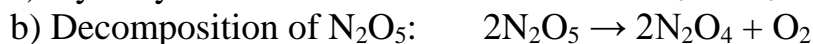
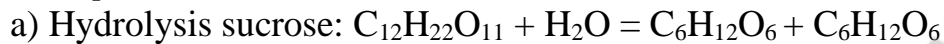

c) Decay of radioactive elements

3. Second order reactions.

Kinetic equation is $V = -\frac{dC}{dt} = k_2 C^2$ or $V = -\frac{dC}{dt} = k_2 C_1 C_2$, where k_2 is the rate constant.

The units of k_2 are therefore $\text{sec}^{-1} \cdot (\text{concentration}^{-1})$.

$$[k_2] = [\text{sec}^{-1}(\text{concentration}^{-1})] = [\text{liter} \cdot \text{mol}^{-1} \cdot \text{sec}^{-1}]$$

It should be noted that the rate constant for a second order reaction depends on the units of concentration used.

On separating the variables in equation $-\frac{dC}{dt} = k_2 C^2$; $-\frac{dC}{C^2} = k_2 dt$ and

integrating, we obtain $\frac{1}{C} = k_2 t + \text{const}_2$. The constant of integration may be determined if the concentration C is known for a given time t . For instance if the initial concentration at $t = 0$ is known, then $\text{const}_2 = \frac{1}{C_0}$, whence $\frac{1}{C} - \frac{1}{C_0} = k_2 t$,

or
$$k_2 = \frac{1}{t} \cdot \frac{C_0 - C}{C_0 \cdot C}$$

Examples:

a) Most well known second order reactions take place in solution

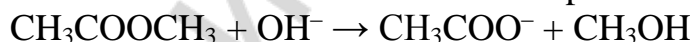

The «saponification» of an ester differs from first order aqueous hydrolysis in that the two reactants are present in approximately equal concentration, and both these concentrations affect the rate of reaction.

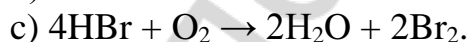
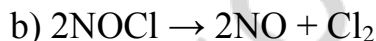

The units of rates of different order reactions are equal and therefore we can compare them.

The reaction rate constants have different units and we cannot compare them. It may be compared the rate constants of chemical reactions if orders of reactions are equal.

4.5. HALF – LIFE OF A REACTION

The time in which half of the reactant is consumed is called the half-life of a reaction. It is the time in which the concentration of a reactant is reduced to one half of its initial concentration and is written as $t_{1/2}$.

1). Putting $t_{1/2}$ and $C = \frac{C_0}{2}$ into equation for the first order reaction we obtain

$$k_1 = \frac{2,303}{t} \lg \frac{C_0}{C} = \frac{2,303}{t_{1/2}} \lg \frac{C_0}{1/2C_0} = \frac{2,303}{t_{1/2}} \lg 2 = \frac{2,303 \cdot 0,3010}{t_{1/2}} \Rightarrow t_{1/2} = \frac{0,693}{k_1}$$

This equation shows that half-life for a first order reaction is independent of the initial concentration.

2). For a second order reaction the half-life is:

$$k_2 = \frac{1}{t_{1/2}} \frac{C_0 - 1/2C_0}{C_0 \cdot 1/2C_0} = \frac{1}{t_{1/2} \cdot C_0}, \text{ whence } t_{1/2} = \frac{1}{k_2 C_0}$$

This equation shows that half-life for a second order reaction depends on the initial concentration of the reactant.

The more $t_{1/2}$ the more substance is in the organism. This concept is important for toxicology and pharmacology.

For simple reactions powers in kinetic equations are the corresponding stoichiometric coefficients in chemical equation $aA + bB \rightleftharpoons cC + dD$ and $\frac{dC}{dt} = k[A]^a[B]^b$.

This regularity is in accordance with the Law of mass action which is formulated by Guldberg and Waage (1867).

The Law of mass action is a particular case of base postulate of chemical kinetics and is only applied for simple reactions.

The Law of mass action states that for a homogeneous system at constant temperature the rate of simple reaction is directly proportional to the active masses of reactants in powers are the corresponding stoichiometric coefficients in chemical equation.

4.6. MOLECULARITY

It is defined as the number of molecules colliding and leading to chemical transformations. Molecularity characterizes the simple reaction, i.e. elementary act of the reaction (individual steps by which a reaction proceeds).

Molecularity has a definite physical sense .

Classification of molecularity:

1. *Unimolecular reactions.*

To unimolecular reactions belong some molecular decompositions and intramolecular rearrangements. Thus, the gas reaction $I_2 = 2I$ is unimolecular;

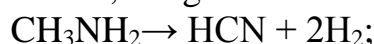



For simple unimolecular reactions $V = kC$, where C is the concentration of the initial substance.

2. Bimolecular reactions.

Bimolecular reactions are those resulting from collision of two molecules of the same or different species: $\text{CO} + \text{Cl}_2 \rightleftharpoons \text{COCl}_2$; $\text{I}_2 + \text{H}_2 \rightleftharpoons 2\text{HI}$
 $V = kC_1C_2$, where C_1 and C_2 are the concentrations of the reactants.

3. Trimolecular reactions.

To trimolecular reactions belong those which require a collision between three molecules (of the same or different species) in order to take place. In the general case the equation for the rate of simple trimolecular reactions assumes the form $V = kC_1C_2C_3$; an example of such a reaction is $2\text{NO} + \text{H}_2 = \text{N}_2\text{O} + \text{H}_2\text{O}$.

Theoretically higher molecularities are possible, but actually the simultaneous collision of three molecules is already highly improbable and trimolecular reactions are encountered rarely. Practically no reactions of a higher molecularity are known.

Molecularity is always a whole number and never greater than three. A molecularity of four is not known because collision of four particles in a single step is not favourable.

When the equation of the reaction indicates that a large number of molecules participate, this usually means that the process must proceed in a more complicated manner, namely through two or more consecutive stages of which each is due to collision between two, or, rarely, three molecules.

For example, $3\text{H}_2 + \text{N}_2 \rightleftharpoons 2\text{NH}_3$. It is a complex reaction.

For simple reactions the order of reaction and molecularity coincides. For complex reactions the order of reaction and molecularity doesn't coincide more off.

Let's take another reaction: $\text{H}_2\text{O}_2 + 2\text{HI} \rightarrow \text{I}_2 + 2\text{H}_2\text{O}$.

The oxidation of iodide ions to iodine by hydrogen peroxide solution is known to proceed via the following mechanism:

First step $\text{H}_2\text{O}_2 + \text{HI} \rightarrow \text{HOI} + \text{H}_2\text{O}$ slow

Second step $\text{HIO} + \text{HI} \rightarrow \text{I}_2 + \text{H}_2\text{O}$ fast

General rate of this reaction is determined by the slowest step, which is called the rate controlling or rate determining step.

The *seeming molecularity* of this reaction is three. This reaction is complex; the order of this reaction is two. It is known, if molecularity and the order don't coincide, it means:

- 1) the reaction is complex,
- 2) the rate of this reaction is limited by rate determining step.

4.7. THE EFFECT OF TEMPERATURE ON THE RATE OF CHEMICAL REACTION

Besides the concentrations of the reactants, the reaction rate must be influenced by the temperature, since raising the temperature increases the velocity of motion of the molecules, thus increasing the number of collisions. This dependence between the temperature and the reaction rate was first analyzed by Vant-Hoff (1887).

Vant Hoff's Rule: *each 10-degree rise in temperature approximately will speed up the reaction by 2–4 times.*

At temperature T the reaction rate is V_T at temperature $T+10$ the reaction rate is V_{T+10} then $V_{T+10}/V_T = \gamma$, where γ is *Vant Hoff's coefficient*.

From that equation we have: $V_{T+10} = V_T \cdot \gamma$ or in general $V_T = V_0 \gamma^{\Delta T/10}$.

The number characterizing the acceleration of a reaction due to raising the temperature 10°C is often called the temperature coefficient of the reaction or Vant Hoff's coefficient. For most reactions the values of these coefficients under ordinary conditions lie between 2 and 4. As the temperature is raised, the coefficients decrease and gradually approach unity.

The γ shows how many times does the reaction rate increase for a rise in temperature of 10°C . But this dependence is very rough.

4.8. COLLISION THEORY

The collision theory gives more exact dependence (function) between temperature and the rate of reaction.

This theory is connected with Arrhenius (1889).

The rate of homogeneous reactions depends on a number of collisions of the reacting particles per unit time. The number of collisions, in turn, is directly proportional to the concentration of the reactants.

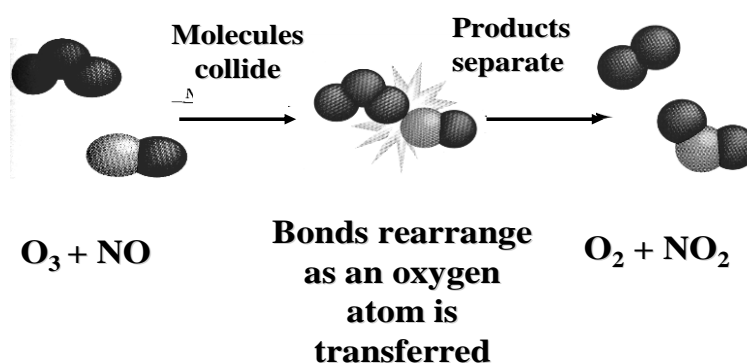

Fig. 4.3. The reaction between ozone and NO is believed to occur by a mechanism that consists of the single bimolecular step shown here in a molecular view

The collision theory is built on a number of assumptions.

1. A chemical reaction takes place when collisions take place between the reacting particles: atoms, molecules or ions.

2. No each collision between reactants is effective; effective in the sense that a reaction occurs.

According to the collision theory that only those collisions which involve more than a certain amount of energy, result in the formation of products. Obviously, not all collisions between reactants can lead to a reaction (fig. 4.2).

Energetic diagram (fig. 4.4) shows a rate of chemical reaction (elementary step of the reaction).

Reaction coordinate is a function of distance between atoms.

The term «reaction coordinate» refers to the relative distance between particles involved in the reaction. An average kinetic energy doesn't enough for overcoming of threshold energy.

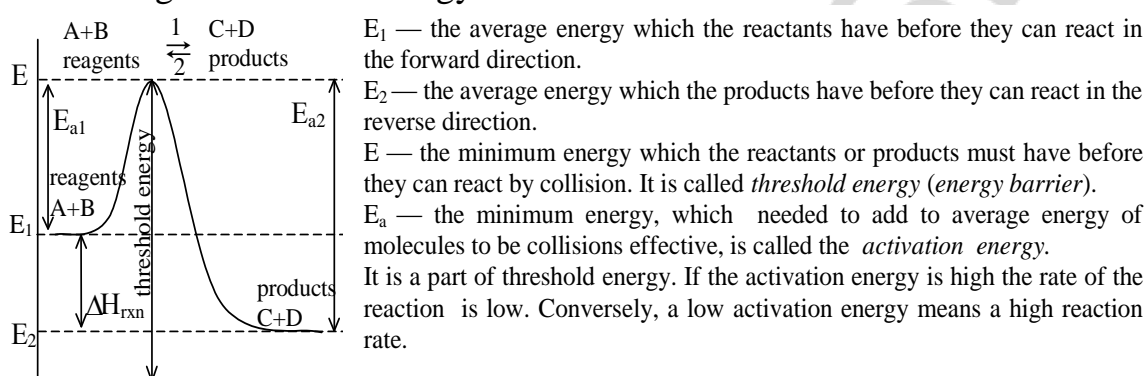

E_{a1} — the activation energy of forward reaction (1). E_{a2} — the activation energy of reverse reaction (2).

$E_{a1} < E_{a2}$

ΔH_{rxn} — is the heat effect of a reaction. According to the graph of fig. 4.1, ΔH of forward reaction (1) is negative ($\Delta H < 0$). In other words this reaction is exothermic ($E_1 > E_2$). ΔH of reverse reaction (2) is positive ($\Delta H > 0$), i. e. an endothermic reaction ($E_2 < E_1$).

Fig. 4.4. Energetic diagram

Normally, only a small fraction of the reacting molecules have enough kinetic energy to exceed the activation energy. The higher the temperature the greater the kinetic energy of reacting molecules and the larger is a fraction of active molecules in a mixture. Thus increase in temperature accelerates most chemical reactions.

According with Arrhenius the fraction of active collisions from total numbers of collisions is denoted as α and equals $\alpha = e^{-E_a/RT} = Z/Z_0$, where e is the base of natural logarithm; Z_0 is the total number of collisions; Z is the number of active collisions; E_a is the energy of activation [$J \cdot mol^{-1}$]; R is the molar gas constant equal to $8.314 J/mol K$; T is absolute temperature.

From expression Z (the number of active collisions) can be obtained:

$$Z = Z_0 e^{-E_a/RT}, \text{ where } \alpha = e^{-E_a/RT}$$

If a large-sized molecules react (proteins) it should be taken into account the steric factor P . It is known that collisions even between active molecules do

not always result in a reaction. The molecules must have a definite orientation. The proteins have active groups and macromolecules of proteins must have a definite orientation to collide their active groups.

The steric factor **P** takes into account a definite orientation or a favourable spatial collision.

The factor **P** is proportional to the ratio of the number of ways of the mutual orientation of the molecules favourable for proceeding of a reaction to the total number of possible ways of orientation: the greater this ratio the more rapidly will a reaction proceed. The steric factor P is usually much smaller than unity; it has an especially great influence on the rate of reactions proceeding with the participation of complex molecules (for example proteins), when the total number of various possible orientations is very great, and the number of favourable orientations are very limited:

$$Z = Z_0 \cdot P \cdot e^{-E_a/RT}$$

Arrhenius suggested the equation: $k = A \cdot \alpha$, $k = A \cdot e^{-E_a/RT}$, where k is rate constant; A is the total numbers of double collisions per second in 1cm³ of reaction system, A is a constant known as Arrhenius or frequency factor or A is a constant preexponential factor independent of the temperature and concentration; $\alpha = e^{-E_a/RT}$ is exponential factor, it is called Boltzmann factor and gives the fraction of collisions with energies greater or equal to activation energy.

Two important conclusions can be drawn from the Arrhenius equation:

- a) at constant temperature the greater the activation energy, the slower is the reaction;
- b) as temperature increases, rate of reaction also increases.

As the rate constant k is a product of two multipliers A and $e^{-E_a/RT}$ the k is a measure of the number of activated molecules per unit volume or it has a sense of the number of active collisions.

The temperature generally affects the exponential factor to a greater extent than the preexponential one. It is explained that the elevation of the reaction rate with increasing of temperature only depends on increasing the fraction of active collisions from total number of collisions. The higher temperature T, the less E_a/RT and the higher $A \cdot 1/e^{E_a/RT}$.

The following conclusions can be drawn from equation $k = A \cdot e^{-E_a/RT}$:

1. Even a slight decrease in the activation energy increases the rate of reaction quite substantially.
2. The temperature generally affects the reaction rate to a greater extent when the activation energy of a reaction is higher.
3. Reactions with high activation energies proceed at low rates when the temperature is low, but the influence of the temperature on the rate of such reactions is usually more appreciable (the temperature coefficient γ is larger).

The Arrhenius equation shows that the rate constant of a reaction grows with a decreasing activation energy.

Calculation of Activation energies from the Arrhenius equation. Let us see how equation $k = A \cdot e^{-E_a/RT}$ is applied for determining the activation energy. This equation is considerably simplified if the logarithm of the rate constant is taken as a function of the reciprocal absolute temperature:

$$\ln k = \ln A - \frac{E_a}{R} \cdot \frac{1}{T} \quad \text{or} \quad \lg k = \lg A - \frac{E_a}{2,3R} \cdot \frac{1}{T}$$

Calculate the rate constant for different temperatures.

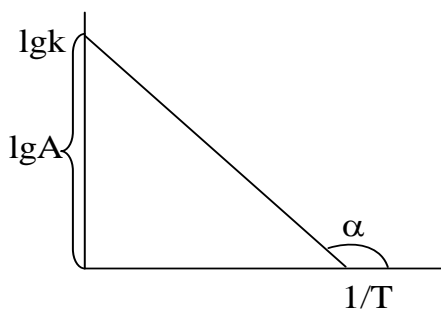

Fig. 4.5. The relationship between $\lg k$ and $1/T$

The experimental data $\frac{1}{T}$ and $\lg k$ usually give a straight line (fig. 4.5). Hence the logarithm of the rate constant of a reaction is practically linearly related to the reciprocal temperature ($1/T$):

$$\operatorname{tg} \alpha = - \frac{E_a}{2,3R}; \quad E_a = - 2,3R \operatorname{tg} \alpha \quad \text{at} \quad 1/T = 0; \quad \lg k = \lg A.$$

The collision theory gave an idea about active collisions and activation energy, proposed calculations for many reactions, but this theory is not free from limitations.

First of all the collision theory didn't explain the mechanism of the collision.

The collision theory doesn't explain reaction's mechanism, influence of a solvent and other factors on the rate of a reaction.

The collision theory only states that reaction can proceed after active collision from total number of collisions.

4.9. CONCEPT ABOUT KINETICS OF COMPLEX REACTIONS

Most reactions are complex.

The kinetics of complex reactions consisting of simple reactions, connected in one way or another, depends upon the nature of their interrelation and on the ratio of their reaction rates. Typical forms of such interrelations are: *simultaneous, consecutive, conjugate, reversible* reactions.

The theory of these reactions is based on the principle that when several reactions occur simultaneously, each takes place independently and each obeys the kinetic equations of the simple reactions.

1. *Simultaneous reactions* are those of the type

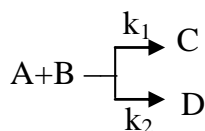

In such reactions the initial substance or substances can react simultaneously in different directions. An example of parallel reactions is the decomposition of potassium chlorate, which at moderate temperatures may occur in two parallel directions:

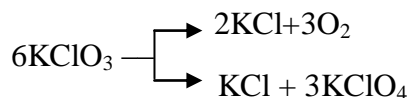

The other reaction is nitration of toluene. This reaction is the first stage for manufacture of novocain.

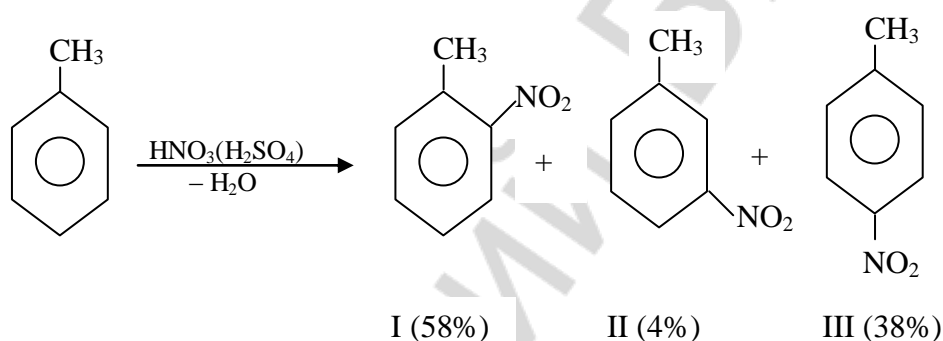

Toluene reacts with a mixture of concentrated nitric and sulphuric acids. The first product is a mixture of ortho- and para-nitro toluene (I,III). The latter product is very important for manufacture of anesthetic.

Simultaneous reactions are most frequently encountered in organic chemistry. For instance in the nitration of toluene with nitric acid in the presence of concentrated sulphuric acid the nitro group may occupy either the meta-, ortho- or the para-position (II, I, III).

If the reactions differ considerably in rate the reaction with the highest rate is usually called the *main reaction* and the others *side reactions*. However, if the difference is not very great, the main reaction is considered to be that which leads to the desired product, although its rate may be lower.

2. *Consecutive reactions* are those of the type $A \xrightarrow{k_1} B \xrightarrow{k_2} C$, where B is an intermediate in the formation of C, and k_1 and k_2 are the rate constants of the two stages of the reaction.

Scheme is that for the simplest type of consecutive reactions. It occurs in two stages, each of which is a simple unimolecular reaction. In the general case the number of stages may be more than two, and the stages may be not unimolecular.

Consecutive reactions are very wide spread. Among them is hydrolysis of dicarboxylic acid esters of glycol esters or of diacyl chlorides. The kinetics of

consecutive radioactive transformations may be considered as a particular case of the kinetics of a series of consecutive first order reactions.

A simple illustration of consecutive reactions may serve the saponification of diethyl oxalate by sodium hydroxide, which proceeds in two consecutive stages:

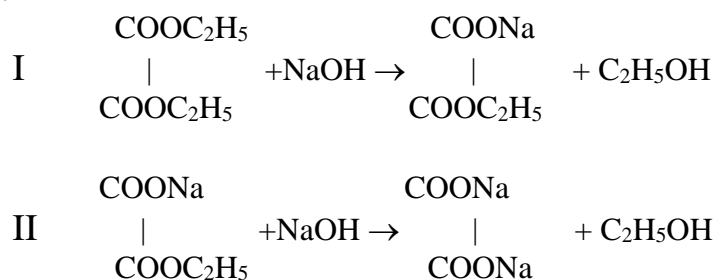

Calculation of the rates of consecutive reactions in the general form is very complicated. We shall only point out that *if one of the stages proceeds at a considerably lower rate than all others the over-all rate of the reaction will be determined by the rate of this stage.*

3. *Conjugated reactions* are defined as reactions of the type:

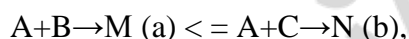

of which one, for example (a), takes place only together with the other, i.e. induced by the other (b). In such cases the substance C is an initiator for the first reaction. An example of such reactions are: hydrolysis of ATP (b) and the synthesis of proteins and peptides (a) in the living organism.

The free energy released by hydrolysis of ATP is necessary for the synthesis of proteins and peptides in living organism.

$\Delta G < 0$ hydrolysis of ATP — exergonic reaction;

$\Delta G > 0$ formation of peptide bond — endergonic reaction.

4. *Reversible reactions*

Reversible reactions proceed under given conditions both in the forward and reverse directions simultaneously $A+B \xrightleftharpoons[k_2]{k_1} C+D$, where k_1 is the rate constant of forward reaction; k_2 is the rate constant of the reverse reaction.

The state of a system when the rates of the forward and reverse reactions are equal: $V_1 = V_2$; $k_1 C(A)C(B) = k_2 C(C)C(D)$ is called a state of chemical equilibrium.

It is readily seen that on reaching a state of chemical equilibrium the concentration of each component of the reaction will remain constant.

Chemical equilibrium is dynamic, i. e. its setting in does not mean that the reaction has stopped.

Chemical equilibrium is characterized quantitatively by a quantity known as the *chemical equilibrium constant*.

The chemical equilibrium constant is the ratio of the rate constant of the forward and reverse reactions: $\frac{k_1}{k_2} = \frac{C(C)C(D)}{C(A)C(B)} = K_c$, where K_c is the chemical equilibrium constant expressed in terms of the equilibrium concentrations of the reactants and products.

The equilibrium constant determines the extent of a process by the instant of reaching the equilibrium state. The larger this quantity, the greater is degree of conversion of the reactants into the products.

The equilibrium constant depends on nature of the reactants and the temperature.

5. *Chain reactions.* Up to now, we dealt with chemical reactions proceeding comparatively simply. There is a broad group of reactions, however, that proceed in a more complicated way. Here, the formation of macroscopic amounts of the product is the result of a chain of elementary events of interaction. Such reactions are known as chain ones.

Chain reactions proceed with the participation of *active centers* – atoms, ions or radicals (fragments of molecules) having unpaired electrons and displaying, as a result, a very high reactivity.

The active centers are the initiators of chains of consecutive transformations of substances.

A simple example of a chain reaction is the reaction between gaseous bromine and hydrogen expressed by the ordinary equation: $H_2 + Br_2 = 2HBr$.

The chain reactions consist of some steps.

The first step – the initiation of the chain. Bromine molecules dissociate and this process can be expressed by the equation: $Br_2 \rightarrow Br^\cdot + Br^\cdot$.

The second step the propagation (and branching) of the chain

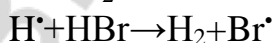
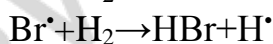
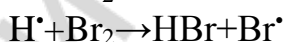
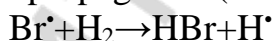

The third step the breaking of the chain (or the termination of the chain):

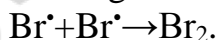

The same mechanism can prevail for the reaction between hydrogen and chlorine, oxidation of hydrocarbons, burning, explosions, polymerization reactions.

This is why the theory of chain reactions is the scientific foundation of a number of important branches of engineering and chemical technology.

Radical reactions proceed in vivo under the affect of different free radicals OH^\cdot , HOO^\cdot , ROO^\cdot , O_2^\cdot and some other. Scientists came to the belief that accumulation of free radicals in intracellular fluids is one reason for aging.

Rate of radical reactions can be increased greatly under the influence of radiation. Even small dozes of radiation can accelerate generation of free radicals.

Free radicals cause the destruction of cell membranes, suppress immune system of people, and cause different diseases. Radical reactions can be retarded by antioxidant substances: vitamins A, E, C and Selenium compounds.

Chains reactions also include nuclear chain reactions proceeding in atomic reactor or upon the explosion of an atomic bomb.

6. *Photochemical Reactions*. Photochemical reactions are reactions that take place under the influence of light (visible light, ultra-violet) or more seldom, infrared rays. Such reactions can occur in gases, liquids and solids. Molecules of reacting substances are excited by absorbing quanta of light under the photochemical effect of light, i.e. become reactive or decompose into ions and free radicals.

The photochemical reactions are characterized by quantum output (γ).

$$\gamma = \frac{\text{(an amount) a number of molecules of products}}{\text{an amount of absorbed quanta}}$$

The most important photochemical reaction is undoubtedly the photosynthesis taking place in plants. For example the reaction $6\text{CO}_2 + 6\text{H}_2\text{O} \rightarrow \text{C}_6\text{H}_{12}\text{O}_6 + 6\text{O}_2$ occurs in the presence of light. Under the action of solar light chlorophyll converts the CO_2 of the air into complex molecules of organic substances. In this case the light energy transforms into the energy of chemical bonds. This process is endothermal, taking place with increase in the Gibbs free energy ($\Delta G > 0$). It cannot occur in the absence of light.

Photochemical reactions are highly varied. Among them are the photosynthesis of carbohydrates carried out by plants under the action of the sun's rays, the photographic processes, luminescence phenomena, decolourization of dyes, etc. Photochemical reactions also greatly differ chemically. Under the action of light synthesis (phosgene, hydrogen chloride), decomposition (hydrogen peroxide), oxidation, etc. may take place.

The photochemical reactions are applied in medicine – the oxidation of bilirubin at jaundice of premature babies, the photochemical processes underlie mechanism of vision.

4.10. CATALYSIS AND CATALYSTS

Substances that are not consumed in a reaction, but affect its rate, are called *catalysts*. The phenomenon of the change in the rate of a reaction under the action of such substances is known as *catalysis*. Reactions proceeding under the action of catalysts are called *catalytic*.

The action of a catalyst in the majority of cases is explained by the fact that it lowers or increases the activation energy of a reaction. The catalyst is called *negative*, when it increases the activation energy; the catalyst is called *positive*, when it lowers the activation energy (table 4.1).

In the presence of a catalyst a reaction proceed through other intermediate stages than without it, and these stages are more accessible from the energy viewpoint.

Table 4.1

Activation energy of catalytical and noncatalytical chemical reactions

Reactions	E _m kJ/mol		Catalyst
	without a catalyst	with a catalyst	
C ₂ H ₄ → C ₂ H ₆	180	40	Pt
		8	Cu
2H ₂ O ₂ → 2H ₂ O + O ₂	750	55	I ₂

The catalyst doesn't effect on the total number of collisions in practice but has effect on the activation energy.

Catalyst have no effect on chemical equilibrium since they equally accelerate or lower the direct or reverse reactions. Catalysts only accelerate or lower the establishment of equilibrium in the system. *Catalysts have no effect on the equilibrium constant (K_c)*.

Depending on the physical state of the catalyst and reacting substances, *homogeneous and heterogeneous catalyses* are distinguished.

Examples of a *homogeneous catalysis* are:

a) the oxidation of CO (in the gaseous state in the presence of water vapour) by oxygen $2\text{CO} + \text{O}_2 \xrightarrow{\text{H}_2\text{O}} 2\text{CO}_2$;

b) $2\text{SO}_2 + \text{O}_2 \xrightarrow{\text{NO}} 2\text{SO}_3$;

c) the action of various enzymes in biological processes.

Examples of a *heterogeneous catalysis* are: a) the synthesis of ammonia

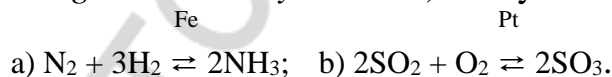

Autocatalysis is a process when a product of a reaction acts as a catalyst. An example of autocatalytic reaction is:

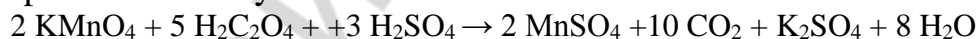

Catalyst: Mn²⁺

Catalysts are used very broadly in the chemical industry.

4.11. ENZYMES

Catalysis plays a very great role in biological systems. Most chemical reactions proceeding in the digestive system, in the blood and cells of animals and man are catalytic reactions. The catalysts, which in this case are known as enzymes, are simple or complex proteins. Thus, saliva contains enzyme ptyalin, which catalyzes the transformation of starch into sugar. An enzyme in the stomach, pepsin, catalyzes the decomposition of proteins. The human organism contains about 30000 various enzymes; each of them is an effective catalyst of the corresponding reaction.

Distinctive traits (properties) of enzymes:

1. *High catalytic activity. The high enzymatic activity.*

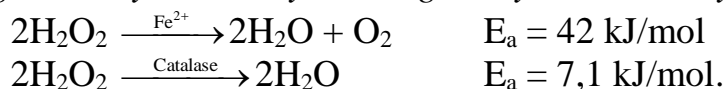

In the presence of the enzyme catalase (found, in particular, in the erythrocytes), this reaction can be effected at a much greater rate, yielding the same end products of hydrogen peroxide breakdown. Hydrolysis urea: by acid $E_a = 103 \text{ kJ/mol}$; by enzyme urease $E_a = 28 \text{ kJ/mol}$.

2. *Highly specific to substrate. High enzymatic specificity to substrate. High selectivity (one enzyme activates only one or two biochemical reactions).*

Enzymes exhibit specificity of action. In many instances, this property is the essential characteristic.

For example, pepsin splits the proteins of animal and vegetal origin but doesn't split carbohydrates or fats. Amylase splits starch, but doesn't split a saccharose although they are built of glucose residues.

3. *Enzymes act under mild conditions:* body temperature $25^\circ\text{--}40^\circ\text{C}$; normal pressure.

4. *Enzymatic reactions proceed without side reactions (side effects).*

5. *The rate of any enzymatic reaction depends on the enzyme and substrate concentrations.* The greater the enzyme concentration the greater the rate of enzymatic reaction. i. e. the reaction rate is proportional to the concentration of the enzyme present. The enzymatic reaction rate is proportional to the substrate concentration too.

At low substrate concentrations the reaction rate is directly proportional to the substrate concentration $V = k_1C$ and obeys the first order kinetics. At high substrate concentrations, the reaction rate attains a maximum and becomes constant, independent of the substrate concentration $[S]$. In this instance, the reaction obeys the zero order kinetics: $V = V_{\text{max}} = k_0$ (as the enzyme becomes fully saturated with substrate) and is wholly determined by the concentration of enzyme (fig.4.5).

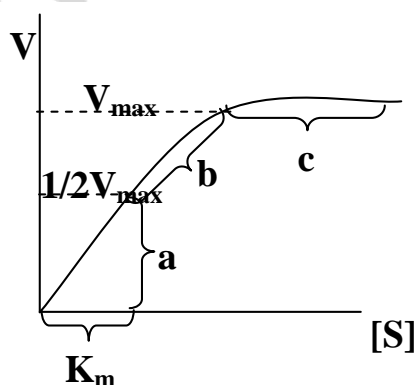

Fig.4.5. Theoretical relationship between the enzymatic reaction rate (V) and the substrate concentration[S] at a constant concentration of the enzyme

- a) first order reaction (of $[S] > K_m$, the reaction rate is proportional to the substrate concentration);
- b) mixed order reaction;
- c) zero order reaction ($V = V_{max}$, and the reaction rate is independent of the substrate concentration).

In their studies on enzyme saturation effect, L. Michaelis and M. Menten have developed a general theory of enzymatic kinetics.

They proposed the following chemical reaction $E + S \xrightleftharpoons[k_2]{k_1} [ES] \xrightarrow{k_3} E + P$, i. e. the enzyme E reacts with the substrate S to form an intermediate complex [ES] which further dissociates into a free enzyme and the reaction product P.

V_{max} is the maximum rate of reaction for complete saturation of enzyme with substrate.

The substrate concentration of which enzymatic reaction rate V is half the maximum rate i. e. $V = 1/2V_{max}$ is called by the *Michaelis constant* K_m .

K_m characterizes stability of enzyme-substrate complexes. The lower is K_m , the higher stability of a complex.

Factors affecting enzymatic reactions are:

1. *Temperature*
2. *Acidity and basicity of medium*
3. *Enzyme inhibitors.*

Enzymes work best at an optimum pH value, which varies from enzyme to enzyme. Most enzymes that are active within cells have a pH optimum fairly close to the range of pH within which cells normally function (fig.4.6). For example, the pH optima of two digestive enzymes, pepsin and trypsin, occur at about pH 2 and pH 8 respectively.

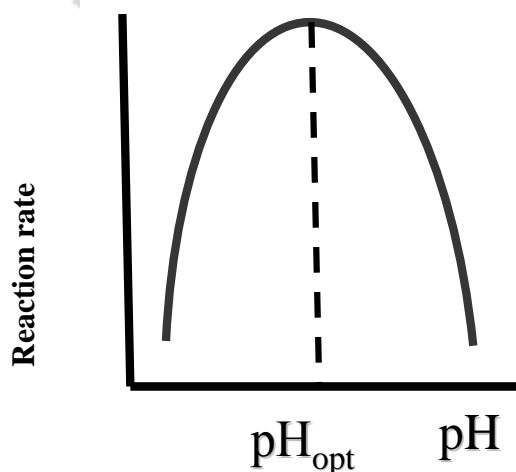

Fig. 4.6. The effect of acidity on enzymes' activity

We will consider two forms of inhibition (there are others):

1. Competitive inhibition (fig.4.7).
2. Noncompetitive inhibition (fig.4.8)

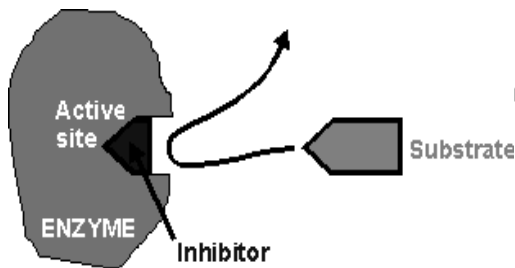

Fig. 4.7. Competitive inhibitors generally structurally similar to substrate and bind to active site – keeping out the substrate

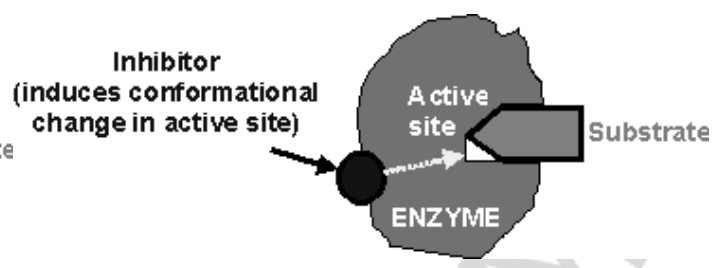

Fig. 4.8. Noncompetitive inhibitors bind away from the catalytic site but cause a conformational change to be transmitted to the active site

Practical application of Enzymes. Enzymes find wide application in many branches of food industry such as bread baking, brewing, wine production, tea production, tanning and fur dressing, cheese industry, cookery (in preparatory treatment of meat), etc. In recent years, enzymes are being increasingly used in chemical industry for carrying out chemical reactions such as oxidation, reduction deamination, decarborylation, dehydration, and condensation as well as for resolving and separating α -amino acid isomers for use in industry, agriculture and medicine.

At present, a new branch of knowledge, the industrial enzymology, is emerging, laying down the basis for further advance in biotechnology. An enzyme covalently bound («grafted») to an organic or inorganic carrier is called the *immobilized enzyme*. The technique of enzyme immobilization opens a route to the solution of key problems in enzymology including the provision for high specificity of enzymes and improvement to their stability, the ease of utilization and the feasibility of repeated use and application to flow processes of chemical synthesis. The industrial applications of such enzyme based techniques have become known as the *engineering enzymology*.

The immobilized β -galactosidase is used as means to decrease the milk sugar content in milk, which helps in dealing with the problem of lactose intolerance. Moreover, the milk thus processed can be stored in a frozen state for a longer period of time without souring.

Cellulose can be converted to glucose through the use of immobilized cellulases. In principle, the engineering enzymology can provide a means for obtaining alimentary products, in particular, carbohydrates, from liquid fuel (petrol) by splitting it to glyceraldehyde and then proceeding, with the participation of enzymes, to the synthesis of glucose and starch.

The progress in enzymology is increasingly gaining ground in medicine, especially, in many aspects of prophylaxis, diagnosis, and therapy. A notable progress has been recorded in a novel branch of enzymology — *medical enzymology*.

Medical enzymology is now advancing in three major directions.

1. *Enzymopathology*, which is concerned with the investigation of enzymatic activity in norm and pathology. As has been ascertained many hereditary disturbances of metabolism originate in the defect of a definite enzyme. For example a hereditary disease, phenylketonuria, manifested by neurologic disturbances, is the lost capacity of the liver cells to synthesize the enzyme that catalyzes the conversion of phenylalanine to tyrosine.

2. The second trend is *enzymodiagnosics* which is concerned with both the use of enzymes as selective reagents for identification and quantization of normal and abnormal chemical substances in blood plasma, urine, gastric juice (for example, for enzymatic urinary analyses of glucose, proteins and other substances, not detectable when they are in norm in urine, and the qualitative and quantitative analyses of the enzymes themselves in biological fluids under pathology. It should be remembered, however, that out of the whole wealth of enzymes (over 2000) that have been discovered in nature (and, partly, in the human organism), the diagnostic enzymology makes use of a rather limited set of enzymes and besides, for the diagnosis of a still smaller number of diseases (hepatitides, myocardial infarction, organic damage of the liver and others). Thus, the level of lipase, amylase, trypsin and chymotrypsin becomes drastically elevated in diabetes, malfunction of the pancreas, hepatic diseases, and other states.

3. The third trend in medical enzymology – *enzymotherapy*, i. e. the use of enzymes and regulators of enzymatic activity.

In the clinic, pepsin, trypsin and mixtures thereof are used to treat the gastrointestinal tract. RNase, DNase, hyaluronidase, collagenases, elastases taken separately or in combination with proteins, are used for the treatment of wounds, skin burns, and for the removal of edemas, hematomas, keloid cicatrices (in pulmonary tuberculosis). Enzymes are also applied in the treatment of cardiovascular diseases and for the dissolution of blood clots, for these purposes the immobilized streptokinase has been obtained.

CHAPTER 5

Solutions and Their Properties

5.1. THERMODYNAMICS OF THE PROCESS OF SOLUTION FORMATION

A solution is a homogeneous system consisting of two or more components the relative quantities of which may vary over a fairly wide range.

The most important are liquid solutions, which will be considered in this guide.

Any solution consists of a dissolved substance called the solute and the medium in which the solute is uniformly distributed as molecules or ions, called the solvent.

A solvent is a component that determines the state of a solution. It is usual to think of the component present in the largest amount as the solvent and the other component(s) as the solute. Solvents can be polar (H_2O , concentrated H_2SO_4) and non-polar (benzene, acetone, alcohols).

Water is the most important solvent in nature and the most abundant substance in the world. The unique physicochemical properties of water are responsible for its numerous biological functions in a human body. Water has one of the highest polarities of all liquids. This property makes water an excellent solvent for ionic compounds. Due to its very high heat capacity water regulates temperature of a cell from the heat generated by metabolic processes; due to its high molar heat of vaporization water protects a human body from overheating.

The human body is made mainly of water ($\frac{2}{3}$ of the body mass). Different organs and tissues contain variable amount of water: brain contains 75 % of water and even moderate dehydration or lack of water can cause headaches and dizziness; heart and muscles — 75 % of water; bones — 22 % of water; lungs and liver — 86 % of water; kidneys and blood — 83 % of water.

The loss of $\frac{2}{3}$ volume of intra-cellular fluid may cause death. The excess of water is also dangerous; it may result in cell swelling and edema.

The process of solution formation is a spontaneous process. When a solute is dissolved in a solvent, we mean that the attractive forces between solute and solvent particles are great enough to overcome the attractive forces within the pure solute and solvent. When solutes are dissolved, they become solvated if solvent molecules are bonded firmly to solute molecules or ions. If water is the solvent, this is called more specifically hydration.

Solubility is the maximum amount of material that will dissolve in a given amount of solvent at a given temperature to produce a stable solution. According to the solubility amount the solutes are divided into soluble, insoluble and low-soluble.

If two liquids mix to a considerable degree to form a solution they are said to be mixable. In contrast, immiscible liquids will not mix to form a solution; they will exist in contact with each other as separate layers. The nonpolar

liquids octane (a component of gasoline) and benzene are miscible; they mix in all proportions to form a homogeneous solution. On the other hand, polar water and nonpolar octane are immiscible.

A sugar is quite soluble in water, hydrogen bonding between sugar and water is strong enough that energy is supplied to disrupt the sugar/ sugar and water/ water interactions. On the other hand, sugar is not soluble at all in CCl_4 or other nonpolar liquids.

Salt dissolves in water because strong ion-dipole forces lead to strong ion hydration and help to break down the cation-anion attraction in the crystal lattice.

The heat or enthalpy of solution ($\Delta H_{\text{solution}}$) can be estimated from the lattice energy of NaCl (ΔH_1) and the heat of ion hydration to form aqueous hydrated ions (ΔH_2). According to Hess's law, the heat of solution is the sum of ΔH_1 and ΔH_2 . For NaCl there are: $\Delta H_{\text{solution}} = 774\text{kJ/mole} + (-760\text{ kJ/mole}) = +14\text{ kJ/mole}$ and the solution process is only slightly endothermic. This means that the energy required to break down the lattice (lattice energy) is smaller the energy given off in case the ions are hydrated (enthalpy of hydration).

The dissolution is a spontaneous process and free energy change ΔG is less than zero ($G < 0$). But the quantity (magnitude) and the sign of ΔG is determined by entropy and enthalpy factors:

$$\Delta G = \Delta H - T\Delta S \quad (5.1)$$

A dissolving is a physicochemical process composed of three main steps:

- 1) A destruction of a solute's crystal lattice which proceeds with heat absorption ($\Delta H_{\text{phase transformation}} > 0$);
- 2) A formation of solvates or hydrates complexes which runs with heat releasing ($\Delta H_{\text{hydration}} < 0$);
- 3) A diffusion of solute particles throughout a solution ($\Delta H_{\text{diffusion}} \approx 0$).

Thus the overall heat (enthalpy) of dissolution ($\Delta H_{\text{dissolution}}$) is an integral magnitude which is calculated as:

$$\Delta H_{\text{dissolution}} = \Delta H_{\text{phase transformation}} + \Delta H_{\text{hydration}}. \quad (5.2)$$

Heat of a solution process is defined as a heat amount absorbed or released when one mole of a solute is dissolved in the endless amount of a solvent under standard conditions.

Dissolving of most solids is endothermic ($\Delta H_{\text{dissolution}} > 0$) since the amount of heat absorbed in the first step exceeds the amount of heat released in the second step of a process. Dissolving of most gases is exothermic ($\Delta H_{\text{dissolution}} < 0$) since the first step of a process doesn't occur (gases do not form crystals under normal conditions). Dissolving of one liquid in another liquid is in fact a diffusion of one liquid into another. This process is accompanied by negligibly low heat effect ($\Delta H_{\text{dissolution}} \approx 0$), since diffusion proceeds without any heat absorption or releasing.

If the salt NaCl is dissolved it is transformed from the solid state to the liquid one. In this case $\Delta H_{\text{phase transformation}}$ is greater than zero, i. e. $\Delta H_{\text{phase transformation}} > 0$ (the heat is absorbed). The ions in solution form hydrates and this process is always exothermic, i. e. $\Delta H_{\text{hydration}} < 0$.

Thus, there are two variants: 1) if $\Delta H_{\text{phase transformation}} > \Delta H_{\text{hydration}}$, then $\Delta H_{\text{dissolution}} > 0$ and the process is endothermic; 2) if $\Delta H_{\text{phase transformation}} < \Delta H_{\text{hydration}}$, then $\Delta H_{\text{dissolution}} < 0$ and the process is exothermic.

The process of dissolution (endothermic or exothermic) depends on the entropy factor. So:

$$\Delta S_{\text{dissolution}} = \Delta S_{\text{phase transformation}} + \Delta S_{\text{hydration}}. \quad (5.3)$$

Because $\Delta S_{\text{phase transformation}} > 0$ (solid substance transforms into liquid), $\Delta S_{\text{hydration}} < 0$ (the disorder is diminished in system) and $\Delta S_{\text{phase transformation}} \gg \Delta S_{\text{hydration}}$, ΔS of dissolution is always greater than zero, i.e. $\Delta S_{\text{dissolution}} > 0$.

5.2. THE IDEAL AND NON-IDEAL SOLUTIONS

In thermodynamics all solutions are divided in two groups: ideal and non-ideal (or real) solutions. Liquids form an ideal solution only if they have nearly the same size and related constitution. Liquid heptane and hexane form an ideal solution because the interaction between a hexane molecule and another hexane molecule is the same as the interaction between a heptane molecule and another heptane molecule or between a hexane molecule and a heptane molecule. In short there is no interaction between molecules of a solute and molecules of a solvent.

Mixing of two substances results in an ideal solution only when:

1) ΔH mixing is zero, i. e. no heat is absorbed or released during dissolution: $\Delta H = 0$, but $\Delta G = \Delta H - T\Delta S$ and $\Delta G = -T\Delta S$. Entropy is increased because $\Delta G < 0$.

2) ΔV mixing is zero, i. e. the total volume of the solution is equal to the sum of the volumes of the pure components mixed to form a solution: $\Delta V = 0$.

There are no such solutions in nature. Non-ideal solutions are formed with a change in volume and enthalpy. The ideal solutions are close to dilute solutions.

All solutions have definite physical properties which depend on the nature of a solute, solvent and concentration (density, viscosity, conductivity). But dilute solutions of non-electrolytes have a number of properties quantitative expression of which depends only on the number of solute particles in a solution and on the nature of a solvent and not on the nature of the solute. They are:

- 1) Depression of the vapour pressure of a solvent over a solution;
- 2) Elevation of the boiling point of a solution;
- 3) Depression of the freezing point of a solution;
- 4) Osmosis and the osmotic pressure of the solution.

5.3. COLLIGATIVE PROPERTIES OF SOLUTIONS

The above properties are commonly referred to as colligative or collective properties because they are bound together through their common origin. Colligative properties depend only on the number of solute particles present, and not on their nature.

The first Raoult's Law deals with the vapour pressure lowering: the vapour pressure of the solution containing the nonvolatile solute is always smaller than that of the pure solvent.

When sugar is dissolved in water, the vapour pressure of the solution is different from that of pure water.

At the surface of a solution there are molecules of water as well as sugar molecules. Water molecules can leave the liquid and enter the gas phase, exerting a vapour pressure. However, there are not as many water molecules at the surface as in pure water, because some molecules have been displaced by dissolved sugar molecules.

Therefore, not as many water molecules are available to leave the liquid surface, and the vapour pressure is lower than that of the pure water at a given temperature. Hence, we may come to a conclusion that the *vapour pressure of the solvent*, P_{solvent} , will be proportional to the relative number of solvent molecules in a solution, that is, to their mole fraction, χ_{solvent} , then we have

$$P_{\text{solvent}} = P^{\circ}_{\text{solvent}} \chi_{\text{solvent}}, \quad (5.4)$$

where $P^{\circ}_{\text{solvent}}$ is the vapour pressure of the pure solvent.

In any solution, the mole fraction of the solvent will always be less than 1, so the vapour pressure of the solvent over the solution (P_{solvent}), must be less than the vapour pressure of the pure solvent ($P^{\circ}_{\text{solvent}}$). This *vapour pressure lowering*, $\Delta P_{\text{solvent}}$, is given by: $\Delta P_{\text{solvent}} = P^{\circ}_{\text{solvent}} - P_{\text{solvent}}$

Substituting $P^{\circ}_{\text{solvent}} \chi_{\text{solvent}}$ for P_{solvent} , we obtain $\Delta P_{\text{solvent}} = P^{\circ}_{\text{solvent}} - (P^{\circ}_{\text{solvent}} \chi_{\text{solvent}})$

or

$$\Delta P_{\text{solvent}} = (1 - \chi_{\text{solvent}}) P^{\circ}_{\text{solvent}}$$

In a solution that has only the solvent and one nonvolatile solute, the sum of the mole fractions of the solvent and the solute must be equal to 1.

$$\chi_{\text{solvent}} + \chi_{\text{solute}} = 1$$

Therefore, $1 - \chi_{\text{solvent}} = \chi_{\text{solute}}$, and the equation for $\Delta P_{\text{solvent}}$ can be rewritten as

$$\Delta P_{\text{solvent}} = P^{\circ}_{\text{solvent}} \cdot \chi_{\text{solute}} \quad (5.5)$$

or relative vapor pressure lowering is

$$\frac{P_0 - P}{P_0} = \chi_{\text{solute}}. \quad (5.6)$$

That is, the lowering of the vapour pressure of the solvent is proportional to the mole fraction (the relative number of particles) of the solute.

To make the equation (5.5) available for electrolytes' solutions the Van't Hoff's factor or the isotonic coefficient i , must be added:

$$\Delta P_{\text{solvent}} = P^{\circ}_{\text{solvent}} \frac{i n_{(\text{solute})}}{i n_{(\text{solute})} + n_{(\text{solvent})}} \quad (5.7)$$

The Van't Hoff's factor characterizes ionization of electrolytes, and its relationship with the degree of ionization is given below

$$\alpha = \frac{i - 1}{n - 1} \quad (5.8)$$

where n — the number of ions contained in a molecule.

5.4. THE SECOND RAOULT'S LAW

The Ebullioscopic Raoult's Law: the boiling-point of the solution containing the nonvolatile solute is always higher than that of the pure solvent.

The boiling-point of a liquid is a temperature under which its vapour pressure equals the external atmospheric pressure.

$$\Delta T_b = E \times C_m \quad (\text{for nonelectrolytes}) \quad (5.9)$$

$$\Delta T_b = i \times E \times C_m \quad (\text{for electrolytes}) \quad (5.10)$$

where ΔT_b is boiling-point elevation, which is equal to: $\Delta T_b = T_2 - T_1$, where T_1 and T_2 are boiling-points of a solvent and a solution respectively, C_m – molality, mol/kg, E – molar boiling-point elevation constant (0.52 for water).

The Cryoscopic Raoult's Law: the freezing-point of the solution containing the nonvolatile solute is always lower than that of the pure solvent.

The freezing-point of a liquid is a temperature under which its vapour pressure equals the vapour pressure of solid solvents.

$$\Delta T_f = K \times C_m, \quad (\text{for nonelectrolytes}) \quad (5.11)$$

$$\Delta T_f = i \times K \times C_m, \quad (\text{for electrolytes}) \quad (5.12)$$

where ΔT_f is freezing point depression, which is equal to: $\Delta T_f = T_1 - T_2$, T_1 and T_2 are freezing points of a solvent and a solution respectively, K – the molar freezing point depression constant (table 5.1).

For human blood plasma ΔT_f equals to 0.56° , for mammal blood plasma ΔT_f is a bit higher 0.58° .

Table 5.1

The Molar boiling-point elevation and the Freezing-point depression constants of several common liquids

Solvent	Normal freezing point ($^\circ\text{C}$)*	K (kg ·degree/mol)	Normal boiling point ($^\circ\text{C}$)*	E (kg·degree/mol)
Water	0	1.86	100	0.52
Benzene	5.5	5.12	80.1	2.53
Ethanol	-117.3	1.99	78.4	1.22
Acetic acid	16.6	3.90	117.9	2.93
Cyclohexane	6.6	20.0	80.7	2.79

* Measured at 1 atm.

The freezing point of depression and boiling point of elevation phenomena can be understood by studying phase diagrams of pure water and of water in an aqueous solution containing a nonvolatile solute (fig.5.1). At 1 atm, the freezing point of a solution lies at the intersection point of the dashed curve (between the solid and the liquid phases) and the horizontal line at 1 atm. Under the same pressure, the boiling point of a solution lies at the intersection point of the dashed curve (between the liquid and the vapor phases) and the horizontal line at 1 atm.

We can use this graph to determine ΔT_f and ΔT_b of a nonvolatile aqueous solution.

Cryoscopy and *Ebullioscopy* are experimental methods to determine molar masses of substances. They are widely used in pharmacology to determine molar masses of different medicines. In general, the freezing-point depression experiment is much easier to carry out.

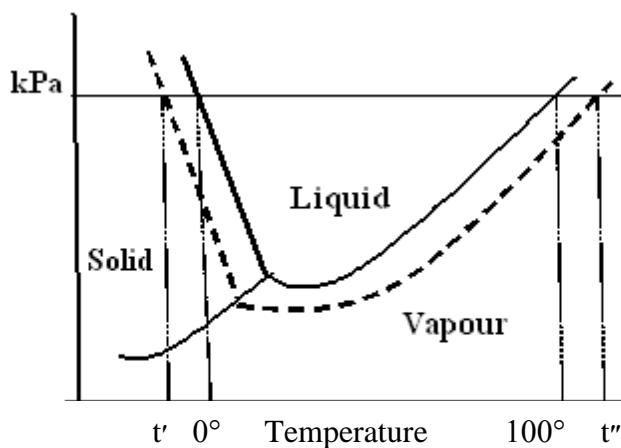

Fig. 5.1. Phase diagrams of pure water (solid lines) and of water in an aqueous solution containing a nonvolatile solute (dashed lines): 0 °C — freezing point of pure water; 100 °C — boiling point of pure water; t' and t'' — freezing and boiling points of solution

5.5. OSMOSIS

Osmosis is a reversible process of water diffusion through a semipermeable membrane from pure water to a solution, or from a dilute solution into a more concentrated one (fig. 5.2). Osmosis is driven by a difference in a solute concentration to the both sides of the membrane. A semipermeable membrane — is a thin sheet of material (such as animal or vegetable tissue or cellophane) through which only certain types of molecules may pass; here, water molecules can pass, but larger molecules cannot

Eventually the pressure exerted by mass of solution will counterbalance the pressure of the water moving through the membrane from the pure-water side.

Osmotic pressure is the minimum pressure that should be applied to the solvent or a more concentrated solution to prevent osmosis (P_{osm} , kPa). Osmotic pressure may be calculated by *the Van't Hoff's equations*:

$$P_{\text{osm}} = RTC_M \quad (\text{for nonelectrolytes}) \quad (5.13)$$

$$P_{\text{osm}} = iRTC_M \quad (\text{for electrolytes}) \quad (5.14)$$

where R is the gas constant (8.314 J/mol K), T is the absolute temperature, M is molarity of the solution.

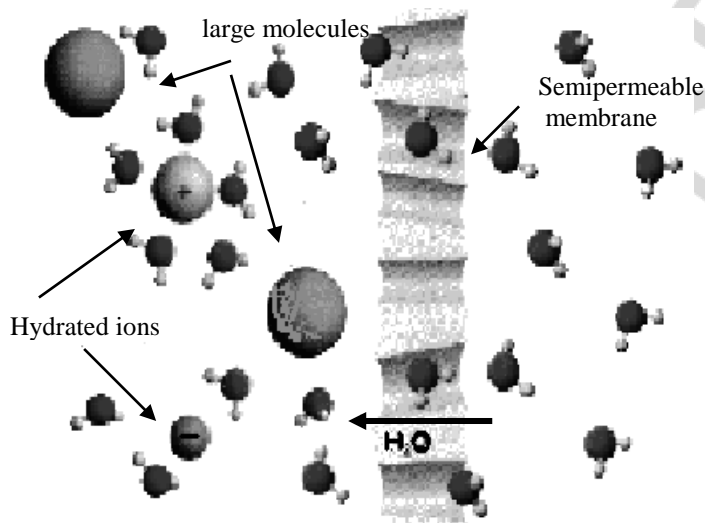

Fig. 5.2. The scheme of the osmosis. Solvent molecules moved through the semipermeable membrane from a region of the lower solute concentration to a region of higher solute concentration. This is an important phenomenon, since it is one of the factors controlling the flow of material in and out of living cells

Osmosis plays a key role in such biological processes as absorption of nutrients, elimination of metabolism waste products, active transportation of water.

Normal osmotic pressure of blood plasma is 740–780 kPa; osmotic homeostasis is maintained by work of kidneys, lungs and skin. Mainly electrolytes are responsible for high osmotic pressure of blood plasma and other biological fluids. Molecules of proteins, which are unable to pass through cell membranes, also contribute to osmotic pressure of blood plasma, but their oncotic pressure is rather low (3–4 kPa).

Most solutions which are used in medicine for intravenous injections are isotonic to blood plasma or have the same osmotic pressure as blood. Their intravenous injections do not disturb osmotic homeostasis of a body. They are:

- a) 0.85–0.9% by mass NaCl solution and
- b) 4.5–5% by mass glucose $C_6H_{12}O_6$ solution.

When a red blood cell is placed in a hypotonic solution ($P_{\text{osm}} < 760 \text{ kPa}$) water tends to move into the cell (fig. 5.3). The cell swells and eventually bursts, releasing hemoglobin and other protein molecules. This phenomenon is known as hemolysis or destruction of blood. Its initial step occurs when osmotic pressure becomes equal to $\sim 360\text{--}400 \text{ kPa}$. Irreversible (total) hemolysis occurs at $260\text{--}300 \text{ kPa}$.

When a red blood cell is placed into a hypertonic solution ($P_{\text{osm}} > 800 \text{ kPa}$) the intracellular water tends to be removed out of a cell by osmosis to a more concentrated, surrounding solution. This process, known as plasmolysis, causes the cell to shrink and eventually cease functioning.

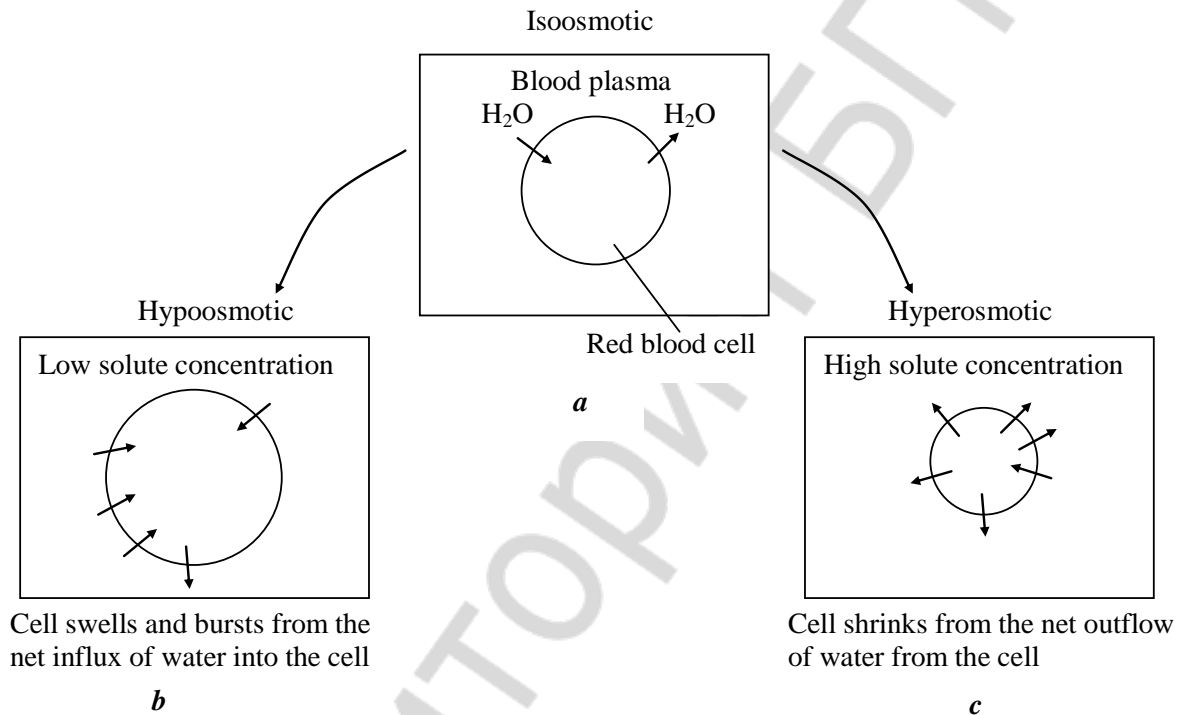

Fig. 5.3. A cell in: isotonic solution (a); hypotonic solution (b); a hypertonic solution (c). The cell remains unchanged in (a), swells in (b), and shrinks in (c)

Nevertheless some hypertonic solutions are applied in medicine. For example, NaCl solution with the mass fraction 10 % is used to heal purulent wounds; and MgSO₄ solution with the mass fraction 25 % is applied to treat hypertonic crises.

Osmolarity and osmolality are concentration units, which characterize the content of solutes not being able to diffuse through semipermeable membranes. Sodium cations and coupled anions make the main impact into the maintenance of osmolality of blood serum (table 5.2).

The impact of blood serum components on its osmolality

Components	%	mmol/kg
Na ⁺ + anions	92	270
K ⁺ + anions	2	7
Ca ²⁺ + anions	1	3
Mg ²⁺ + anions	0.3	1
urea	1.7	5
glucose	1.7	5
proteins	0.3	1
total	100 %	292

Potassium cations and coupled anions make the main impact into the osmotic pressure of the intracellular fluid. Proteins of the blood serum determine to a great extent the distribution of water between the blood stream and the extravascular space.

5.6. ELECTROLYTE SOLUTIONS

The Arrhenius theory of electrolytes dissociation. All biological and many chemical systems are aqueous solutions that contain various ions. The stability of biomacromolecules and the rates of many biochemical reactions are highly dependant on the type and concentration of ions present. It is important to have a clear understanding of the ions in solutions behaviour.

An *electrolyte* is a polar compound that, when dissolved in a solvent (usually water), produces a solution that will conduct electricity. An electrolyte can be an acid, a base, a salt and water itself. *Ionization (dissociation)* is a spontaneous physicochemical process of electrolytes' break down into ions under the influence of water molecules.

The first theory of Electrolytic dissociation was developed in 1884-1887 by Swedish chemist Svante Arrhenius. The basic idea of his theory is that certain substances remain ionized in solution all the time. Arrhenius received the 1903 Nobel Prize in Chemistry for his electrolytic dissociation theory.

The main statements of the Arrhenius theory are:

1. Ionization of electrolytes produces ions which are responsible for solutions' ability to conduct electricity. The degree of ionization (α) can be calculated by the simple equation:

$$\frac{\text{a number of ionized molecules}}{\text{a total number of dissolved molecules}} \quad (5.15)$$

Electrical conductivity of solutions, their osmotic pressure, boiling and melting points depend not only upon their concentration but also upon their ionization per cent:

$$\alpha = \frac{i-1}{n-1} \quad (5.16)$$

where i — the Van't Hoff's factor. In dilute solutions α tends to 1, thus i tends to n , n is a number of ions contained in a molecule. For example, for NaCl n is 2, for Na_2SO_4 — 3 and for Na_3PO_4 it is equal to 4.

3. According to their ability to dissociate into ions, two types of electrolytes can be distinguished. They are weak and strong. However this classification is not absolute. An electrolyte's ionization percent depends not only upon its nature, but also upon a solvent's nature. Thus NaCl in water is a strong electrolyte, but when NaCl is dissolved in benzene, there is no dissociation (NaCl remains as the undissociated substance). The nature of the solvent plays a critical role in the ability of substances to dissociate into ions. In this chapter we shall discuss only water solutions of electrolytes.

Arrhenius theory didn't take into account the interaction of the solute and the solvent, while the modern concept of electrolytic dissociation defines the role of a solvent as an instrument to separate ions and prevent their recombination (fig. 5.4).

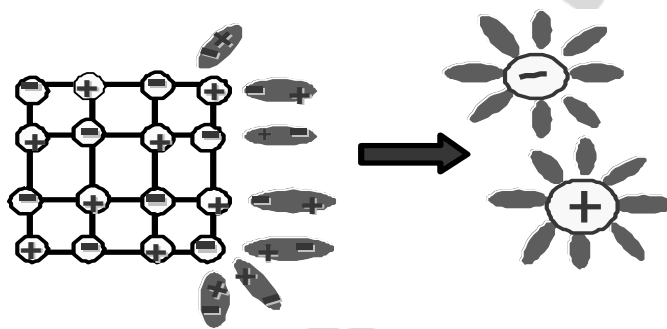

Fig. 5.4. Ionic compound dissociation in water

Most electrolytes are ionic compounds thus water for them is the most effective solvent because of its polarity. Ionization of ionic compounds in water can be represented in fig.5.4.

Each ion in a solution is surrounded by a shell of water molecules. A number of molecules in a shell are defined as a *hydration number*; which can be determined experimentally:

H^+	Li^+	Na^+	NH_4^+	K^+	Rb^+	Cs^+
1	120	66	17	16	14	13

ϵ — dielectric constant of a solvent, which indicates how many times the forces of attraction between ions are reduced in solvent than in vacuum. For water ϵ is ~ 81 , for ethyl alcohol $\epsilon \sim 24$, for most organic solvents ϵ from 2 to 2.5. In water the forces of attraction between ions are reduced by 80 times. So water is the most effective solvent for electrolyte ionization.

Weak electrolytes. Weak electrolytes are polar covalent compounds which undergo reversible ionization in water solutions. They are:

- all organic and most mineral acids (H_2S , H_2SO_3 , HNO_2 , HCN and others);
- bases with low solubility in water;
- water.

In solutions of weak electrolytes equilibrium is maintained between ions and molecules of a substance: $\text{CatAn} \leftrightarrow \text{Cat}^+ + \text{An}^-$

Their ionization degree is always more less than one ($\alpha \ll 1$). Such equilibrium is characterized by ionization equilibrium constants (K_{ion}) expressed as follows:

$$K_{\text{ion}} = \frac{[\text{Cat}^+] \cdot [\text{An}^-]}{[\text{CatAn}]} \quad (5.17)$$

K_{ion} are of several types. The examples of ionization equilibrium constants are:

- acid ionization constant K_a (table 5.3),
- base ionization constant K_b .

Table 5.3

K_a and $\text{p}K_a$ for acid

Acid	$\text{p}K_a$	K_a
H_2SO_3	1.92	0.012
HF	3.13	7.2×10^{-4}
HCOOH	3.70	2.2×10^{-4}
CH_3COOH	4.75	1.8×10^{-5}
HCN	9.00	1.0×10^{-9}
NH_4^+	9.25	5.6×10^{-10}
H_2CO_3	6.52	3.0×10^{-7}
HCO_3^-	10.4	4.0×10^{-11}
H_3PO_4	1.96	0.011
H_2PO_4^-	7.12	7.6×10^{-8}
HPO_4^{2-}	12.3	4.8×10^{-13}
H_2S	6.92	1.2×10^{-7}
HS^-	13	1.0×10^{-13}

The Ostwald's Dilution Law connects ionization degree (α) to a molarity of a solution.

Let's consider a weak acid HA of concentration c (mol/L). Weak electrolyte ionization can be expressed on the following way: $\text{HA} \leftrightarrow \text{H}^+ + \text{A}^-$

At equilibrium, in solution we have

$$[\text{H}^+] = c\alpha, [\text{A}^-] = c\alpha, [\text{HA}] = c - c\alpha = c(1-\alpha):$$

Particles	HA	H^+	A^-
Before ionization (C_M)	c	0	0
Change in concentration when moving to equilibrium	$-c\alpha$	$+c\alpha$	$+c\alpha$
At equilibrium (C_M)	$c - c\alpha$	$c\alpha$	$c\alpha$

The ionization constant for a weak acid (K_a) is expressed by

$$K_a = \frac{[\text{H}^+] \times [\text{A}^-]}{[\text{HA}]} = \frac{c^2 \alpha^2}{c(1-\alpha)} = \frac{c \alpha^2}{(1-\alpha)}$$

For weak electrolytes $\alpha \ll 1$ and $1 - \alpha \approx 1$, hence this equation can be rearranged as $K_a = c\alpha^2$ or $\alpha = \sqrt{\frac{K_a}{c}}$

Because $1/c = V$ — is dilution, we have $\alpha = \sqrt{K_a V}$ (5.18)

The Ostwald's Dilution Law is a physical law stating that the degree of ionization for weak electrolytes is proportional to the square root of the dilution. In other words, it states that the *dissociation degree* of a weak electrolyte grows when the concentration of the solution diminishes.

The treatment of dissociation equilibrium is more complicated for acids that have two or more dissociable protons (diprotic and polyprotic acids). Their dissociation involves several steps and each step is characterized by its own acid ionization constant K_a .

For example, dissociation of a diprotic sulphurous acid H_2SO_3 involves two steps:



K_{a1} is greater than K_{a2} by some six orders of magnitude, thus acid strength of H_2SO_3 is much greater than that of HSO_3^- .

Strong electrolytes. The theory of strong electrolytes was developed in 1923 by Peter Debye and Walter Karl Huckel. The main statements of this theory are:

1. Strong electrolytes are mostly ionic compounds completely dissociated into ions in water solutions. They are:

- mineral acids such as HCl, $HClO_4$, HNO_3 , H_2SO_4 and others,
- hydroxides of Alkali and Earth Alkaline metals such as NaOH, KOH, $Ba(OH)_2$, $Ca(OH)_2$ and others,
- salts.

Strong electrolyte ionization can be represented by a scheme:

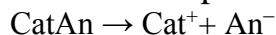

They are 100% dissociated into ions in a solution. The only things present in solutions are ions.

2. All ions in a solution contribute to the ionic strength (I), which characterizes the electric field generated by ions in a solution. It is defined as:

$$I = \frac{1}{2} \sum C_i \cdot Z_i^2$$

where C_i is a molarity of ion i, mol/L, Z is the charge number of ion i.

3. Ions with opposite charges attract one another. As a result, anions are more likely to be found near cations in solution, and vice versa. Overall the solu-

tion is electrically neutral, but near any given ion there is an excess of ions with opposite charges — ionic atmosphere (fig.5.5).

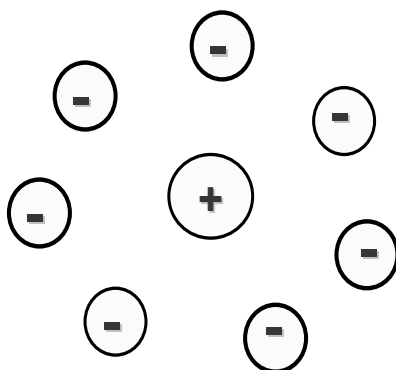

Fig. 5.5. A model of ionic atmosphere

The density of ionic atmosphere depends upon concentration of electrolytes in a solution. In outer electric field an ion and its atmosphere migrate in the opposite directions thus retarding the motion of each other. As the result conductivity of a solution becomes lower than that calculated theoretically.

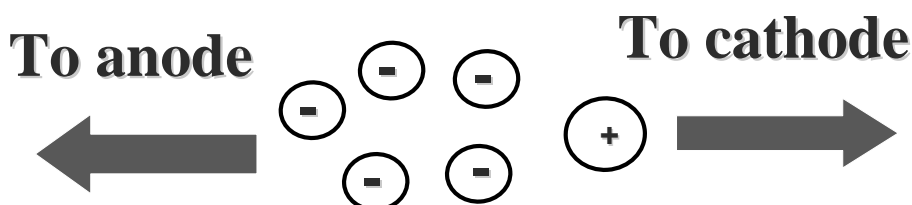

Fig. 5.6. The movement of a cation toward the cathode is retarded by the electric field created by the ionic atmosphere.

The electrostatic forces exerted between ions are enough to cause a deviation from ideal behaviour. It seems that concentration of ions in a solution is smaller than their true concentrations. The effective concentration of ions that takes into account the interaction between them is known as activity (a). Activity is defined by the following formula

$$a = f_a C_M \quad (5.19)$$

where f_a —activity coefficient of an individual ion (cation or anion), which expresses a deviation of a solution from ideal behaviour.

Activity coefficient connects the activity and concentration: at the dilution $C \rightarrow 0$, $a \rightarrow C$, $f_a \rightarrow 1$.

Usually we use activity coefficients of an individual ions measured experimentally (table 5.4). They depend upon ionic strength of a solution and their charge numbers.

$$\lg f_a = -0,5 \cdot z_+ \cdot z_- \cdot \sqrt{I}$$

Ionic Strength and Ion Activity Coefficient

Ions	Ionic strength of the solution								
	0.0005	0.001	0.01	0.02	0.1	0.2	0.3	0.5	1.0
H ⁺	0.98	0.97	0.91	0.90	0.87	0.81	0.80	0.79	0.85
NH ₄ ⁺ , K ⁺ , Li ⁺ , Cl ⁻ , Br ⁻ , I ⁻ , NO ₂ ⁻ , NO ₃ ⁻	0.98	0.96	0.90	0.87	0.75	0.67	0.62	0.55	0.44
OH ⁻ , F ⁻ , ClO ₄ ⁻	0.98	0.96	0.90	0.87	0.76	0.68	0.63	0.56	0.46
Na ⁺ , H ₂ PO ₄ ⁻	0.98	0.96	0.90	0.87	0.77	0.73	0.70	0.67	0.63
Ca ²⁺ , Cu ²⁺ , Zn ²⁺ , Fe ²⁺	0.90	0.87	0.68	0.64	0.41	0.33	0.28	0.25	0.21
Mg ²⁺ , Be ²⁺	0.91	0.87	0.69	0.65	0.45	0.37	0.34	0.28	0.23
PO ₄ ³⁻	0.80	0.73	0.40	—	0.10	—	—	—	—
Al ³⁺ , Fe ³⁺ , Cr ³⁺	0.80	0.74	0.45	—	0.18	—	—	—	—

To describe the real properties of strong electrolyte solutions we should use not their true concentration but their effective concentration or activity. Thus, in the vast majority of cases, molarity must be replaced with activity.

CHAPTER 6

Acid-Base Equilibrium

Acids and bases form a particularly important class of electrolytes. No chemical equilibria are as widespread as those involving acids and bases. The precise balance of their concentrations or pH in our bodies is necessary for the proper function of enzymes, maintenance of osmotic pressure, and so on.

6.1. DEVELOPMENT OF THE ACID-BASE CONCEPT

In 1680, Robert Boyle noted that acids dissolve many substances, they change the colour of certain natural dyes (litmus) from blue to red, and that they lose these characteristic properties after coming in contact with alkalis (bases).

In the eighteenth century it was recognized that acids have a sour taste, they react with limestone producing a gaseous substance (CO₂). Their interaction with bases results in the formation of neutral substances. Lavoisier in 1787 proposed that acids are binary compounds of oxygen. He considered oxygen to be responsible for the acidic properties of that class of substances. The necessity of oxygen was disproved by Humphry Davy in 1811 when he demonstrated that hydrochloric acid contains no oxygen. Davy made a great step forward in the development of the acid-base concept by concluding that hydrogen, rather than oxygen, is the essential constituent of acids.

In 1814 Gay-Lussac discovered that acids are substances which can neutralize alkalis and that these two classes of substances can be defined only in

terms of each other. The idea of Davy and Gay-Lussac provides the foundation for our modern concepts of acids and bases in water solutions.

The Arrhenius Theory. In 1887, a young Swedish chemist, Svante Arrhenius, published a report concerning acids and bases. He knew that solutions containing acids or bases conducted an electric current, and he tried to explain why. He realized that these substances released charged particles when dissolved; he called them Ions (wanderers). He concluded that:

- Acids are substances which produce hydrogen ions in solution
- Bases are substances which produce hydroxide ions in solution.

For example:

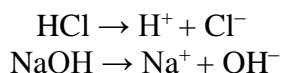

Free hydrogen ions cannot exist in water and cannot be responsible for acidic properties. In fact, they exist as hydrated protons called Hydronium Ions:

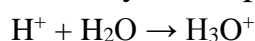

The hydrated proton is usually represented as H_3O^+ , so a better representation for the HCl ionization is:

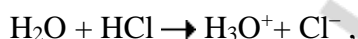

in which a proton is transferred from HCl to the water molecule, where it is bonded to the oxygen atom by a stable coordinate covalent bond.

The Bronsted-Lowry Theory. As chemistry developed, knowledge of catalysts and nonaqueous solutions increased, and it became necessary to redefine the terms acid and base. In 1923, an English scientist, T.M.Lowry, and a Danish scientist, J.N.Bronsted independently proposed that

- An acid is a proton (hydrogen ion) donor.
- A base is a proton (hydrogen ion) acceptor.

The Bronsted-Lowry theory doesn't go against the Arrhenius theory in any way — it just adds to it. In general, any acid-base reaction is described as:



The *conjugate base* of an acid is the remainder of the acid after the proton has been released by the acid. The *conjugate acid* of a base is formed when the base acquires a proton from the acid.

For example, interaction of an acid with water can be represented as

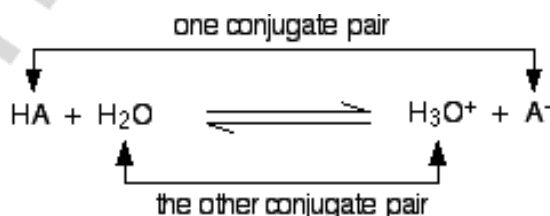

The reaction between ammonia and water also involves two conjugate pairs:

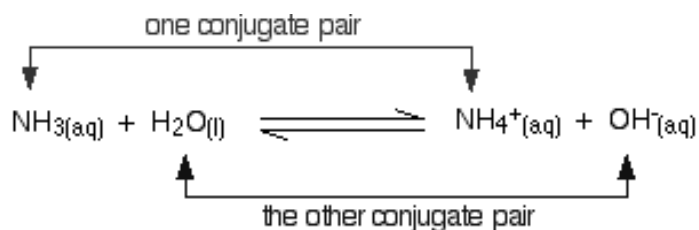

Ammonia is a base because it accepts hydrogen ions from the water. The ammonium ion is its conjugate acid — it can release that hydrogen ion again to reform the ammonia.

A substance which can act as either an acid or a base is described as being amphoteric.

For example water is acting as a base in one case whereas in the other one it is acting as an acid:

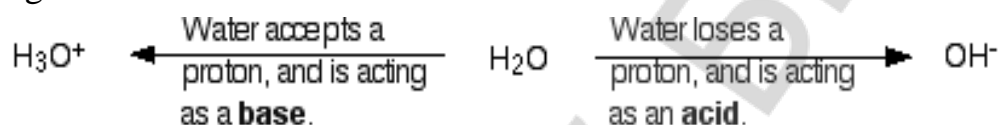

The Lewis Theory. In 1923, the same year that Bronsted and Lowry proposed their theories, Gilbert Newton Lewis, an American chemist, proposed an even broader definition of acids and bases.

- an acid is an electron pair acceptor,
- a base is an electron pair donor.

Lewis focused on electron but not on proton transfer. His definition is more inclusive than the previous, and applies to solutions and reactions which do not even involve hydrogen and hydrogen ions. Consider the reaction between ammonia and boron trifluoride:

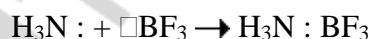

Note that boron has an empty orbital, and can accept two more electrons in its valence level. Since boron trifluoride can accept an electron pair, it is a Lewis acid. Note that the nitrogen atom has an unshared electron pair, which can be donated to the boron. Ammonia is therefore a Lewis base, because it can donate an electron pair.

None of the preceding theories is incorrect. Each succeeding theory includes that of its predecessors. What is true for the most specialized (Arrhenius theory) is also true for the most general (Lewis theory). According to Arrhenius' theory, ammonia is a base because it produces OH^- ion when placed in water. The Bronsted-Lowry theory classifies ammonia as a base because it accepts a proton from H_2O . The Lewis theory classifies NH_3 as a base because it donates an electron-pair to a proton. *What is considered an acid or base in the simplest theory is also considered an acid or a base in the more complex theories.*

Strong Bronsted acids and bases will lead to larger concentrations of $\text{H}^+(\text{aq})$ or $\text{OH}^-(\text{aq})$ for a given number of moles of substance. If these concen-

trations could be measured quantitatively, we would have a way to compare acid and base strengths and to predict more accurately reaction direction and extent.

6.2 THE WATER IONIZATION CONSTANT, K_w

Water auto-ionizes, transferring a proton from one water molecule to another and producing a hydrogen (or hydronium) ion and a hydroxide ion is expressed as follows:

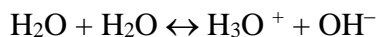

Since hydroxide ion is a much stronger base than water and the hydrogen (hydronium) ion is a much stronger acid than water, the equilibrium lies far to the left side. In pure water at 25°C only one molecule dissociates from 550 million molecules. To express this idea more quantitatively, we can write an equilibrium constant:

$$K = \frac{[\text{H}^+][\text{OH}^-]}{[\text{H}_2\text{O}]} = 1.8 \cdot 10^{-16} \text{ mol/L at } 25^\circ\text{C}$$

However, in dilute aqueous solutions (say 0.1 M solute or less) the concentration of solvent water can be considered to be a constant 55.6 mol/L (1000g/18g/mol = 55.6 mol), so we may write the equilibrium constant as follows:

$$K \cdot [\text{H}_2\text{O}] = K_w$$

$$K_w = \text{Water Ionization Constant} = [\text{H}^+][\text{OH}^-] = 1.8 \cdot 10^{-16} \cdot 55.6 = 1.008 \cdot 10^{-14} = 10^{-14} \text{ at } 25^\circ\text{C}$$

$$K_w = 1.0 \times 10^{-14} \text{ at } 25^\circ\text{C} \quad (6.1)$$

This expression, and the value of the water auto-ionization constant are important and should be committed to memory. In pure water, the transfer of a proton between two water molecules leads to one H^+ and one OH^- . Since this is the only source of these ions, we know that $[\text{H}^+]$ must equal $[\text{OH}^-]$ in pure water. This means that

$$[\text{H}^+] = [\text{OH}^-] = \sqrt{K_w} = \sqrt{1.0 \cdot 10^{-14}} \text{ or } [\text{H}^+] = [\text{OH}^-] = 1.0 \cdot 10^{-7} \text{ M.}$$

The hydrogen ion and hydroxide ion concentrations in pure water are both 10^{-7} M at 25 °C, and the water is said to be neutral. In an acidic solution, however, the concentration of hydrogen ion must be greater than 10^{-7} M. Similarly, in a basic solution, the concentration of OH^- must be greater than 10^{-7} M. Of course, since the product of the H^+ and OH^- concentrations must be equal to 10^{-14} , this means that a basic solution is also characterized by a hydrogen (or hydronium) ion concentration less than 10^{-7} M.

6.3 ACIDITY AND BASICITY OF AQUEOUS SOLUTIONS. THE PH SCALE

Rather than to express hydrogen and hydroxide ion concentrations as very small numbers or as exponentials, it is more convenient to use the pH. The pH

of a solution is defined as the negative of the base-10 logarithm (log) of the hydrogen ion concentration

$$\text{pH} = -\log[\text{H}^+] \quad (6.2)$$

In a similar way, the pOH of a solution is defined as the negative of the base-10 logarithm of the hydroxide ion concentration.

$$\text{pOH} = -\log[\text{OH}^-] \quad (6.3)$$

In pure water, the hydrogen and hydroxide ion concentrations are both $1.0 \cdot 10^{-7}$ M. Therefore,

$$\text{pH} = -\log(1.0 \times 10^{-7}) = -[\log(1.0) + \log(10^{-7})]$$

$$\text{pH} = -[(0.00) + (-7)]$$

$$\text{pH} = 7.00 = \text{pH of pure water}$$

In the same way, you can show that the pOH of pure water is also 7.00. If we take the logarithms of both sides of the expression $K_w = [\text{H}^+][\text{OH}^-]$, we obtain another useful expression.

$$\begin{aligned} K_w &= [\text{H}^+][\text{OH}^-] = 1.0 \times 10^{-14} \\ -\log([\text{H}^+][\text{OH}^-]) &= -\log(1.0 \times 10^{-14}) \\ (-\log[\text{H}^+]) + (-\log[\text{OH}^-]) &= 14.00 \\ \text{pH} + \text{pOH} &= 14.00 \end{aligned} \quad (6.4)$$

The sum of the pH and the pOH of a solution is equal to 14.00 at 25°C.

In general, $\text{pX} = -\log[\text{X}]$. An alternative and useful form of these definitions is:

$$\begin{aligned} [\text{H}^+] &= 10^{-\text{pH}} \\ [\text{OH}^-] &= 10^{-\text{pOH}} \end{aligned}$$

As you will soon see, these equations make it easy to convert *pH or pOH values into hydrogen or hydroxide ion concentrations*, respectively.

Acidity and basicity are important characteristics of aqueous solutions, biological fluids, food products, natural waters and other objects. They are determined by ratio of protons (H^+ or H_3O^+) and hydroxyl ions (OH^-) concentrations and expressed in pH or pOH units.

$$\text{pH} = -\log a(\text{H}^+) \quad (6.5)$$

where $a(\text{H}^+)$ is the activity of the H^+ ions in solution, $a(\text{H}^+) = f_a \cdot [\text{H}^+]$.

Generally, for relatively dilute solutions at low ionic strength f_a tends to 1, so we can use the following approximate equation

$$\text{pH} = -\log[\text{H}^+]$$

where $[\text{H}^+]$ is protons concentration, mol/L. We can also define a pOH scale as follows

$$\text{pOH} = -\log a(\text{OH}^-) \quad (6.6)$$

where $a(\text{OH}^-)$ is the activity of the OH^- ions in solution, $a(\text{OH}^-) = f_a \cdot [\text{OH}^-]$.

Respectively for dilute solutions at low ionic strength

$$\text{pOH} = -\log[\text{OH}^-]$$

where $[\text{OH}^-]$ is hydroxyl ions concentration, mol/L.

In terms of concentrations, we can express the acidity of a solution as follows:

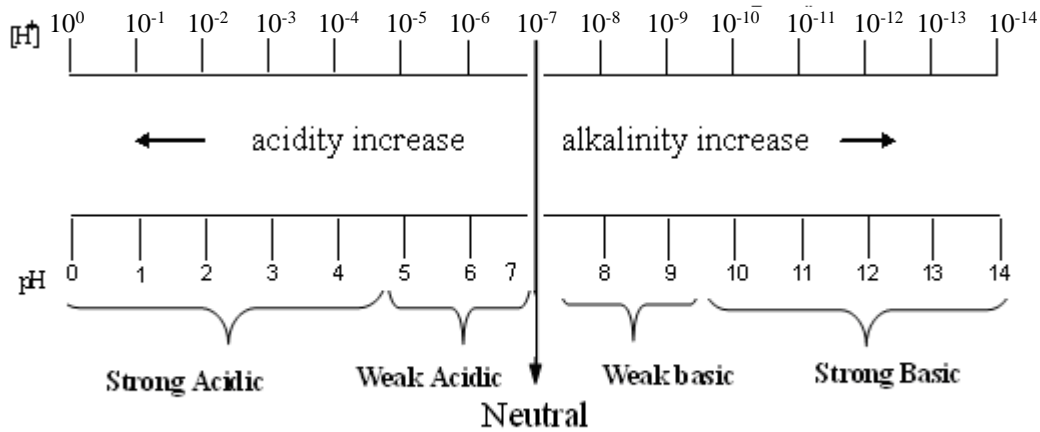

Fig. 6.1. pH scale

in neutral medium $[H^+] = [OH^-] = 10^{-7} \text{ M}$, $\text{pH} = -\log [H^+] = -\log 10^{-7} = 7$;

in acidic medium $[H^+] > [OH^-]$, hence $\text{pH} < 7$;

in basic medium $[H^+] < [OH^-]$, hence $\text{pH} > 7$.

pH of aqueous solutions may be determined experimentally or calculated theoretically.

6.4 PH CALCULATION IN AQUEOUS SOLUTIONS OF WEAK ACIDS AND BASES

a) In aqueous solutions of weak acids

The dissociation of a weak acid, HA, in aqueous solution can be represented by: $\text{HA} + \text{H}_2\text{O} \leftrightarrow \text{H}_3\text{O}^+ + \text{A}^-$

or in a simplified form: $\text{HA} \leftrightarrow \text{H}^+ + \text{A}^-$

According to the law of mass action

$$K_a = \frac{[H^+] \cdot [A^-]}{[HA]} \quad (6.7)$$

where K_a – acid ionization constant.

Weak acids obey the Ostwald Dilution Law, according to which their dis-

sociation degree is: $\alpha (\text{acid}) = \sqrt{\frac{K_a}{C_M}}$

$$[H^+] = \alpha(\text{acid})C_N(\text{acid})$$

$$\text{pH} = -\log [H^+] = -\log \alpha(\text{acid})C_N(\text{acid}) \quad (6.8)$$

b) In aqueous solutions of weak bases.

The treatment of the dissociation of bases is the same as that of acids. For example, when ammonia dissolves in water, it reacts as follows:



By analogy with the acid ionization constant, we can write the base ionization constant K_b , as

$$K_b = \frac{[NH_4^+][OH^-]}{[NH_4OH]} \quad (6.9)$$

Weak bases obey the Ostwald Dilution Law, according to which

$$\alpha \text{ (bases)} = \sqrt{\frac{K_b}{C_M}}$$

where α - ionization degree of weak bases in aqueous solutions.

$$\begin{aligned} [OH^-] &= \alpha \text{ (bases)} C_N \text{ (bases)} \\ pOH &= -\log [OH^-] = -\log \alpha \text{ (bases)} C_N \text{ (bases)} \\ pH &= 14 - pOH \end{aligned} \quad (6.10)$$

6.5 PH CALCULATION IN AQUEOUS SOLUTIONS OF STRONG ACIDS AND STRONG BASES

a) In aqueous solutions of strong acids

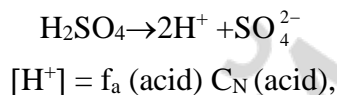

$$[H^+] = f_a \text{ (acid)} C_N \text{ (acid)},$$

where f_a – activity coefficient, for relatively dilute solutions at low ionic strength $f_a \approx 1$

$$pH = -\log [H^+] = -\log f_a \text{ (acid)} C_N \text{ (acid)} \quad (6.11)$$

b) In aqueous solutions of strong bases:



$$[OH^-] = f_a \text{ (bases)} C_N \text{ (bases)}$$

$$pOH = -\log [OH^-] = -\log f_a \text{ (bases)} C_N \text{ (bases)} \quad (6.12)$$

$$pH = 14 - pOH$$

6.6. ACID-BASE STATUS OF A HUMAN BODY

All biological fluids are characterized by constant pH values (table 6.1).

Table 6.1.

PH of some biological fluids

Biological fluid	Average values	Possible deviations
Blood plasma	7.36	7.25–7.44
Cerebrospinal fluid	7.6	7.35–7.80
Gastric Juice	1.65	0.9–2.0
Urea	5.8	5.0–6.5
Saliva	6.75	5.6–7.9
Sweat	7.4	4.2–7.8
Skin	6.8	6.2–7.5

This phenomenon is defined as acid-base equilibrium or acid-base status; it is regulated by biological buffer systems. A disturbance of acid-base status is rather dangerous for people's health since pH deviation may cause:

- Decrease in hormone and enzyme activity;
- Change in osmotic pressure;
- Alteration in rates of biochemical reactions catalyzed by protons.

Even 0.4 pH units deviation from the normal pH value in blood may cause coma or even death of a patient. For babies even 0.1 pH deviations is also very dangerous.

The most dangerous types of acid-base disturbance in blood are:

- acidosis — increase in blood acidity,
- alkalosis — increase in blood basicity,

Two main types of acidosis can be distinguished:

a) Respiratory, caused by hypoventilation of lungs and accumulation of carbonic acid in blood: $\text{CO}_2 + \text{H}_2\text{O} \leftrightarrow \text{H}_2\text{CO}_3$

b) Metabolic, caused by Diabetes Mellitus and some other diseases responsible for extra production of acids.

The excess of food products with high acidity can lead to acidosis as well.

Alkalosis is initiated by:

- (a) Hyperventilation of lungs (for example, neurotic paroxysm),
- (b) The excess of food products with high basicity.

Acidosis correction done by intravenous injection of 4% NaHCO_3 solution: $\text{HCO}_3^- + \text{H}^+ \leftrightarrow \text{H}_2\text{CO}_3$

Soda and another antacidic (hypocidic) drugs are substances which reduce acidity of biological fluids. Alkalosis correction is achieved by injection of 5–15 % ascorbic acid solutions.

Increase in acidity in a mouth is conjugated with food intake (especially sweet). Its gives rise to teeth decay:



Addition of acids shifts equilibrium to the right due to decrease in F-anions:

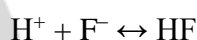

6.7. THE ROLE OF HYDROGEN IONS IN BIOLOGICAL PROCESSES

Biological liquids contain weak and strong acids: HCl , H_2CO_3 , lactic acid and others. There are three types of biological liquid acidity:

Total acidity is a total concentration of weak and strong acids; it is usually detected by titration.

2. Active acidity is equal to activity a (or concentration for the dilute solution):

$$a = f_a \cdot C.$$

Potential acidity is concentration of non-dissociated molecules of weak acids and it is equal to difference between total and active acidities.

Pathological processes may lead to pH changing of several biological liquids. Therefore pH detection of biological liquids is used in diagnostics and therapy control. The detection of medium reaction and hydrogen ion concentration in biological liquids is important in biochemical studies.

The detection of the pH value. *Colorimetric* pH detection is based on colour change of acid-base indicators (table 6.2), whose colour depends on the pH medium. Indicators may be one-coloured (have the colour only in alkaline medium, in acid medium they are colourless – phenolphthalein), and two-coloured (have different colour in alkaline medium and in acid medium – methyl orange).

Each indicator is characterized by a titration *index* and colour change interval.

A titration index pT is the pH meaning in the colour change interval characterized by the most sudden change of the indicator colour. A colour change interval is the pH meaning interval ΔpH with eye-fixed change of the indicator colour. A colour change interval limit approximately equals to $pT \pm 1$.

During the detection of the solution pH you may use only that indicator whose colour change interval includes the pH meaning of the analyzed solution.

Table 6.2

Some common acid-base indicators

Colour Indicator	In acid	In base	ΔpH	pT
Methyl orange	Orange	Yellow	3.1–4.4	3.7
Methyl red	Red	Yellow	4.2–6.3	5.7
Litmus	Red	Indigo	5.0–8.0	7.0
Phenolphthalein	Colourless	Reddish pink	8.2–10.0	9.0

At first pH value is usually measured with the universal indicator. A universal indicator is a mixture of several indicators with different colour change intervals including pH ranging from 1 to 14. This mixture has a definite colour in different medium pH values. Universal indicator paper is a filter paper impregnated with the universal indicator.

Potentiometric solution pH determination is made with the help of an ionometer. The Galvanic cell, applied for this purpose, is a combination of a glass electrode (as an indicator electrode) and a silver-silver chloride electrode (as a reference electrode).

Potentiometric pH determination is widely used in medical practice.

Advantages of potentiometric measurements are:

- Analysis of coloured and turbid solutions pastes and gels.
- Analysis of biological fluids without their destruction.

6.8 BUFFER SOLUTIONS

Buffer solutions or buffers are solutions, which have an ability to resist in case of pH change upon the addition of small quantities of acids and bases.

A mechanism of buffer activity becomes clear on the base of Bronsted-Lowry Acid-Base Theory. Each buffer solution contains a conjugate pair (an acid and its conjugate base), which is responsible for a solution ability to neutralize acids and bases added to it.

pH of a buffer solution may be calculated by Henderson-Hasselbach equation:

$$\text{pH} = \text{pK}_a - \log \frac{[\text{acid}]}{[\text{conjugate} \cdot \text{base}]} \quad (6.13)$$

where $\text{pK}_a = -\log K_a$ (K_a – acid ionization constant).

Classification of buffer solutions. 1. The buffer solution consists of weak acid and its salt. For example, acetate buffer system: $\text{CH}_3\text{COOH}/\text{CH}_3\text{COONa}$

Mechanism of buffer activity is the following:

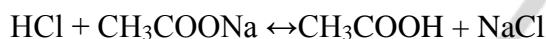

Neutralization of an added acid

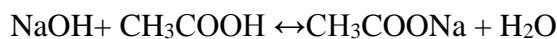

Neutralization of an added base

$$\text{pH} = \text{pK}_a - \log \frac{[\text{acid}]}{[\text{conjugate} \cdot \text{base}]}$$

$$\text{pH} = \text{pK}_a - \lg \frac{[\text{acid}]}{[\text{salt}]}$$

$$\text{pH} = \text{pK}_a + \lg \frac{[\text{salt}]}{[\text{acid}]}$$

$$\text{pH} = \text{pK}_a + \lg \frac{[\text{CH}_3\text{COONa}]}{[\text{CH}_3\text{COOH}]}$$

2. Weak base and its salt. For example, ammonia buffer system: $\text{NH}_3/\text{NH}_4\text{Cl}$. Mechanism of buffer activity is the following:

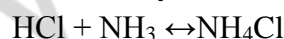

Neutralization of an added acid

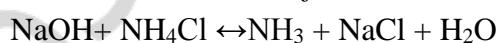

Neutralization of an added base

$$\text{pOH} = \text{pK}_b(\text{NH}_4\text{OH}) + \lg \frac{[\text{NH}_4\text{Cl}]}{[\text{NH}_4\text{OH}]}$$

$$\text{pH} = 14 - \text{pK}(\text{NH}_4\text{OH}) - \lg \frac{[\text{NH}_4\text{Cl}]}{[\text{NH}_4\text{OH}]}$$

3. Two acid salts. For example, Hydro phosphate buffer system: $\text{NaH}_2\text{PO}_4/\text{Na}_2\text{HPO}_4$. Mechanism of buffer activity:

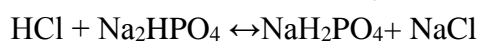

Neutralization of an added acid

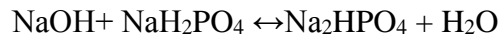

Neutralization of an added base

$$\text{pH} = \text{pK}_a(\text{H}_2\text{PO}_4^-) + \lg \frac{[\text{Na}_2\text{HPO}_4]}{[\text{NaH}_2\text{PO}_4]}$$

4. Acid salt and neutral salt. For example, carbonate buffer system: $\text{NaHCO}_3/\text{Na}_2\text{CO}_3$. Mechanism of buffer activity:

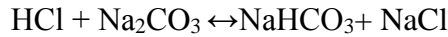

Neutralization of an added acid

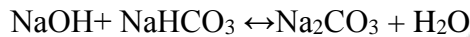

Neutralization of an added base

$$\text{pH} = \text{pK}_a + \lg \frac{[\text{Na}_2\text{CO}_3]}{[\text{NaHCO}_3]}$$

Buffer capacity of a solution (B , mmol/L) is the amount of added acids or bases the buffer solution can tolerate without exceeding a specified pH range.

$$B = \frac{C_N \times V}{\Delta \text{pH} \times V_{BS}} \quad (6.14)$$

where C_N — normality of added strong acid or strong base, mol/L,

V — a volume of an added acid or base, L, ΔpH — change in pH,

V_{BS} — a volume of a buffer solution, L.

Buffer capacity depends upon:

- Concentration: the higher the concentration, the greater is buffer capacity of a solution;
- The ratio of components' concentration

$$B_{\max} \text{ when } \frac{[\text{component 1}]}{[\text{component 2}]} = 1$$

The greater the buffer capacity of a solution, the higher is its activity in supporting acid- base equilibrium.

Biological buffer systems are characterized by: B_A — buffer acids capacity, B_B — buffer bases capacity. Buffer capacity of biological buffers may differ greatly by acids and by bases. Usually $B_A > B_B$, because the amount of acidic metabolites generated in a human body is much greater than amount of basic metabolites. The amount of acidic metabolites synthesized daily in a human body is equivalent to 2.5 L of concentrated HCl.

6.9. BUFFER SYSTEMS OF BLOOD

The most powerful biological buffer systems are contained in blood. They are subdivided into two categories:

- buffers of plasma,

– buffers of erythrocytes.

The pH of blood plasma is maintained at 7.4 by several buffer systems, the most important of which is the $\text{HCO}_3^-/\text{H}_2\text{CO}_3$. In the erythrocyte, where pH is 7.25, the principal buffer systems are $\text{HCO}_3^-/\text{H}_2\text{CO}_3$ and hemoglobin (fig. 6.2).

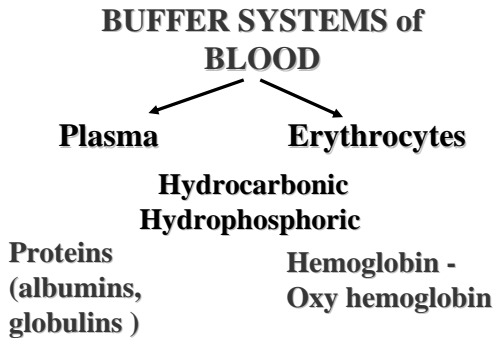
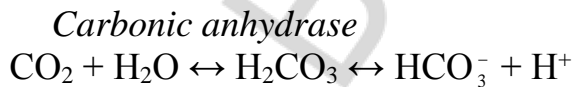

Fig. 6.2. Classification of buffer systems in blood.

Let's start the review buffer systems in blood beginning from the buffers, which present both on blood plasma and erythrocytes.

Hydrocarbonic buffer system. This buffer system involves weak carbonic acid and bicarbonate anion: $\text{H}_2\text{CO}_3/\text{HCO}_3^-$. The formation of a buffer in biological fluids is represented as:



The mechanism of buffer activity:

- a) Neutralization of acids: $\text{H}^+ + \text{HCO}_3^- \leftrightarrow \text{H}_2\text{CO}_3$
- b) Neutralization of bases: $\text{OH}^- + \text{H}_2\text{CO}_3 \leftrightarrow \text{HCO}_3^- + \text{H}_2\text{O}$

In blood plasma the ratio of H_2CO_3 and HCO_3^- concentrations is

$$\frac{[\text{HCO}_3^-]}{[\text{H}_2\text{CO}_3]} = \frac{40}{1}$$

Thus the excess of bicarbonate anion maintains the *base reservoir of blood*.

Its buffer capacity by acids is much greater than buffer capacity by bases:

$$B_A = 40 \text{ mmol/L}; B_B = 1-2 \text{ mmol/L}.$$

Hydrocarbonic buffer system is contained in all biological fluids of a human body. It acts together with other biological buffers. All alterations which proceed in a body effect the concentration of a carbonic system's components. HCO_3^- analysis in blood is an important diagnostical test which signals about respiratory and metabolic diseases.

2. *A hydro phosphoric buffer system.* It is composed of anions of phosphoric acid ($\text{H}_2\text{PO}_4^-/\text{HPO}_4^{2-}$). The mechanism of its buffer activity is given in point 5.8.

This buffer exhibits low capacity in blood is due to low concentration of its components: $B_A = 1-2 \text{ mmol/L}$ and $B_B = 0.5 \text{ mmol/L}$. But hydro phosphoric buffer system is crucial in urea, intracellular fluids and other biological liquids.

3. *Protein buffer system (albumins, globulins)* is a strong buffer which presents in blood plasma but not in erythrocytes.

Proteins are amphiprotic polyelectrolytes which exist as bipolar ions:

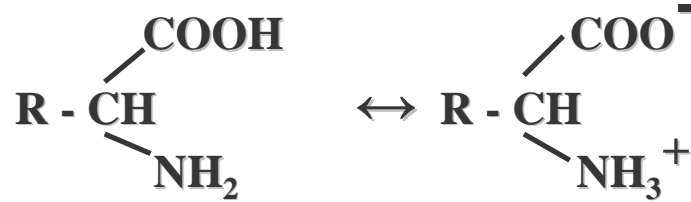

The mechanism of buffer activity is:

a) Neutralization of acids:

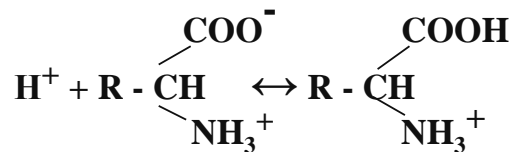

b) Neutralization of bases:

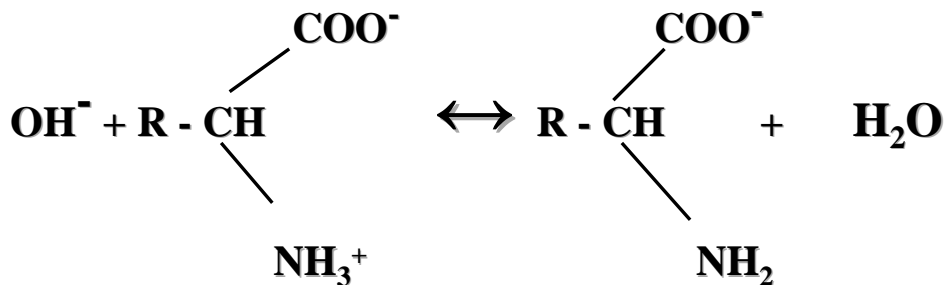

Protein buffer systems are contained not only in blood plasma, but in all biological fluids of a body. Their buffer capacities in blood plasma are:

B_A (albumins) = 10 mmol/L and B_A (globulins) = 3 mmol/L respectively.

4. A *hemoglobin-oxyhemoglobin buffer* system presents in erythrocytes and is responsible for 75 % of blood buffer capacity.

Hemoglobin (HHb) and oxyhemoglobin (HHbO₂), formed by the combination of oxygen and with hemoglobin in the lungs according to the reaction

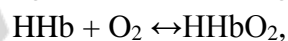

are weak acids although the latter is considerably stronger than the former:

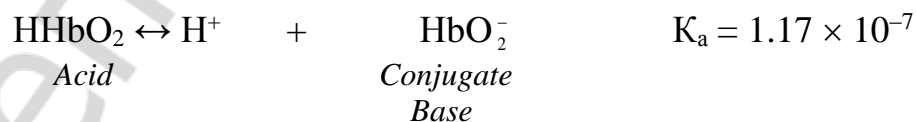
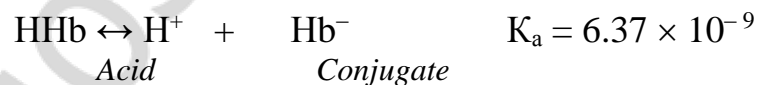

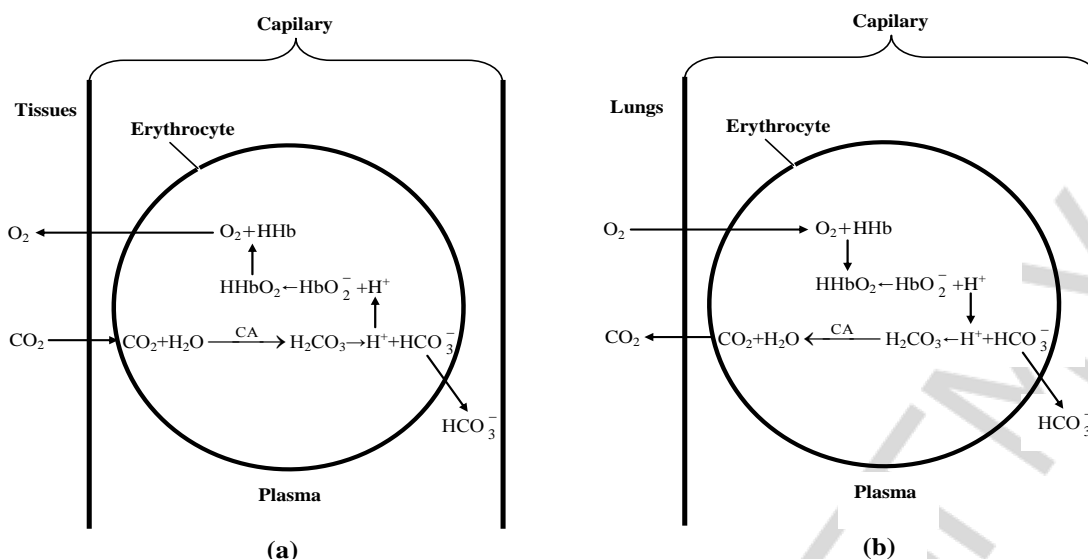
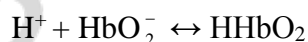
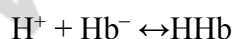

Fig.6.3. Oxygen-carbon dioxide is transported and released by blood. (a) In metabolizing tissues, the partial pressure of CO_2 is higher in the interstitial fluid (fluid in the tissues) than in plasma. Thus, CO_2 diffuses into the blood capillaries and then into erythrocytes. There it is converted to carbonic acid by the enzyme carbonic anhydrase (CA). The protons, provided by the carbonic acid, combine with the oxyhemoglobin anions to form HHbO_2 , which eventually dissociates into HHb and O_2 . Because the partial pressure of O_2 is higher in the erythrocytes than in the interstitial fluid, oxygen molecules diffuse out of the erythrocytes and are carried by plasma to the lungs. A small portion of CO_2 binds to hemoglobin to form carbaminohemoglobin. (b) In the lungs, the processes are reversed.

Hemoglobin and hydrocarbonic buffer systems are working together to deliver oxygen to tissues and to remove carbon dioxide out of tissues. Using several buffer systems, nature has provided an extremely effective gas exchange (fig. 6.3). Biological buffer systems maintain acid-base statuses of a human body.

The mechanism of their buffer activity can be represented as follows:

f) Neutralization of acids:



b) Neutralization of bases:

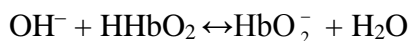
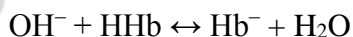

CHAPTER 7

Complex (Coordination) Compounds

Common chemical compounds are built according to the rules of valence: NH_3 , H_2O , HCl , HF , AgCl , BF_3 and so on. These compounds are relatively simple. They can react with each other producing more complex compounds.

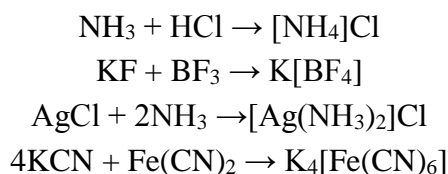

Such compounds got the name of complex (coordination) compounds.

Complex compounds are the compounds where in the nodes of their lattice there are complex ions or neutral complex particles, which can exist either in solutions or in fluxes. The reactions in the result of which these complex compounds are formed are called the *complexation reactions*.

The first theory of the structure of complex compounds was devised by Alfred Verner in 1893.

We should differentiate the inner coordination sphere and the outer sphere. The inner coordination sphere is the aggregate of the central atom (complex former) and the ligands (molecules or ions). The charge of the inner sphere equals the algebraic sum of the charges of the central atom and the ligands. The inner sphere or a complex are enclosed in brackets. As an example let's have a look at the constituent parts of such complex compound as $\text{K}_4[\text{Fe}(\text{CN})_6]$:

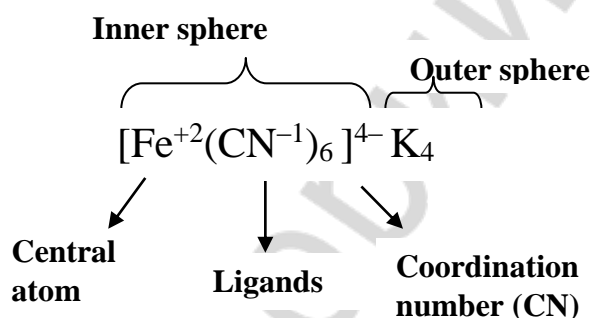

Atoms of a ligand which help to make bonds with the central atom are called *donor atoms*. The most frequently used ligands are those with donor atoms of oxygen, nitrogen and sulphur. The number of ligands participating directly in the bonding with the central atom is called the coordination number.

The outer sphere is the aggregate of all the ions situated outside the inner coordination sphere. The charge of the inner sphere is compensated by the ions of the outer sphere with the opposite sign. Usually the outer sphere consists of simple monatomic and polyatomic ions.

Any element of the periodic table can function as a central atom in the structure of the inner sphere. d- and f- elements show the highest complex forming ability, p-elements have somewhat lower ability and s-elements can function as a central atom very rarely. The central atom can have any oxidation number.



The value of the coordination number of the central atom depends on its nature, oxidation number, the nature of ligands and the conditions for the com-

plexation reaction to take place. The value of the coordination number may vary in different complex compounds from 2 till 8 and higher. The most widespread coordination numbers are 4 and 6. *In most cases the value of the coordination number is twice as high as the oxidation number of the central atom.*

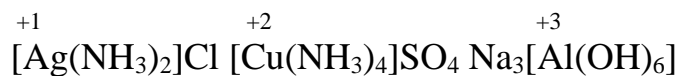

The greater is the charge of the central atom and the smaller is its radius, the more durable is the complex.

As ligands we can find ions and neutral molecules. The number of donor atoms of a ligand forming these coordination bonds with the central atom is called the *dentation* of a ligand. Depending on the number of donor atoms we can distinguish ligands with different dentation. If a ligand forms one coordination bond with the central atom, it's a *monodentate* ligand. The number of monodentate ligands in the inner sphere equals the coordination number of the central atom. Monodentate ligands contain one donor atom: H_2O , NH_3 , OH^- , Cl^- . *Bidentate* ligands contain two donor atoms and form two coordination bonds with the central atom. These are anions SO_4^{2-} , CrO_4^{2-} , molecules of ethylenediamine ($\text{H}_2\text{N}-\text{CH}_2-\text{CH}_2-\text{NH}_2$), aminoacetic acid ($\text{H}_2\text{N}-\text{CH}_2-\text{COOH}$). There are also *polydentate* ligands containing more than two donor atoms. It's, for example, a hexadentate ligand which is the ethylenediaminetetraacetate ion of ethylenediaminetetraacetic acid (EDTA). It forms complexes with many metals owing to the oxygen atom of each of the four carboxylic groups and to both nitrogen atoms:

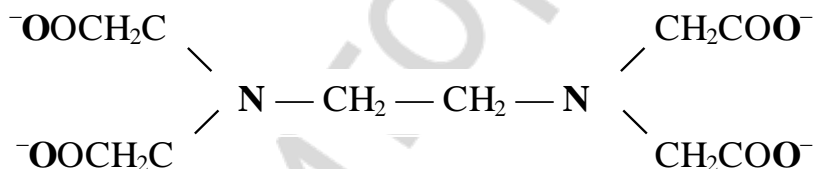

Proteins are the polydentate ligands.

The nature of the chemical bond in complex compounds. Based on the method of valence bonds we can see that *the bonds between the central atom and the ligands are the covalent ones* formed according to the donor-acceptor mechanism. Ligands are the donors of electron pairs and the central atom is the acceptor. Let's consider the formation of a complex ion $[\text{Zn}(\text{NH}_3)_4]^{2+}$:

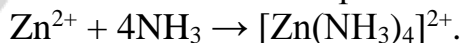

Cation $[\text{Zn}(\text{NH}_3)_4]^{2+}$ includes the central atom of zinc (II). The electron shell of zinc ion has the formula $[\text{Ar}] 3d^{10} 4s^0 4p^0$ and can be represented as follows:

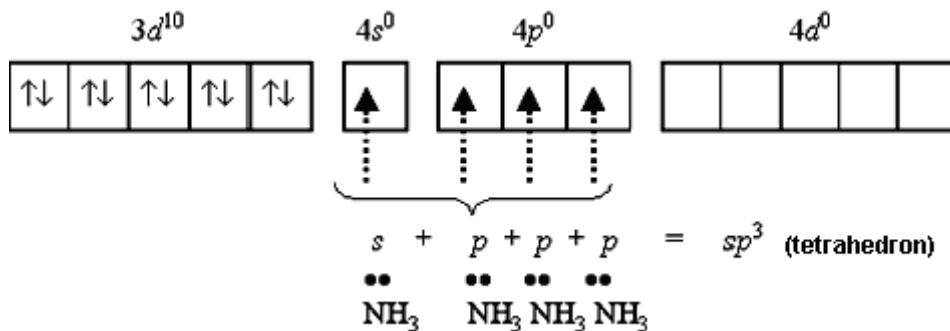

Vacant 4s- and 4p-orbitals of zinc atom form four sp^3 -hybrid orbitals, directed at the corners of a tetrahedron. Each molecule of ammonia has an unshared pair of electrons of nitrogen atom. The orbitals of nitrogen atom containing the unshared pairs of electrons are overlapped by sp^3 -hybrid orbitals of zinc atom forming a complex cation of tetraaminezinc (II) - $[\text{Zn}(\text{NH}_3)_4]^{2+}$:

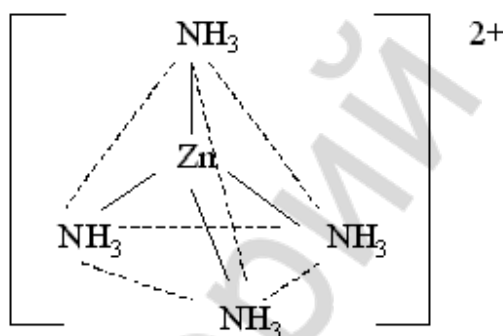

The inner coordination sphere is connected with the outer sphere by an ionic bond.

Cyclic complexes or chelates. Complexes with polydentate ligands contain cycles which include the central atom. Such complexes are called **chelates**. The example of such complex can be ethylenediamine copper (II) complex:

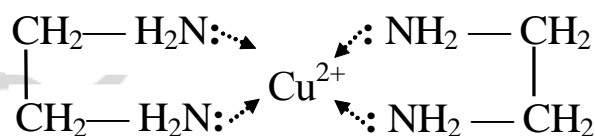

The group of chelates also includes the inner complex compounds which have the central atom linked with ligands by a covalent bond formed according to donor-acceptor and exchange mechanisms. The formation of the inner complex compounds is accompanied by the substitution of one or several protons from the acid functional groups by a metal ion.

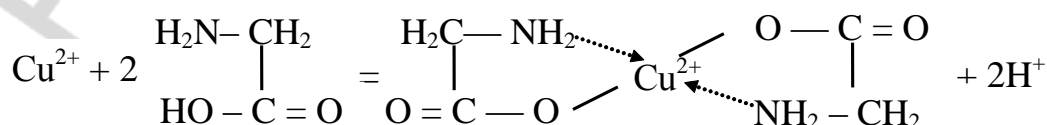

The inner complex compounds are hemoglobin, chlorophyll, vitamin B₁₂, many enzymes and other biologically active compounds.

Classification and nomenclature of complex compounds. I. According to the charge of the inner sphere the complexes can be:

Cationic: [Ag(NH₃)₂]⁺Cl diamminesilver (I) chloride; [Cu(NH₃)₄]²⁺SO₄ tetraamminecopper (II) sulphate.

Anionic: K₄[Fe(CN)₆]⁴⁻ potassium hexacyanoferrate (II); K[Pt(NH₃)Cl₃]⁻¹ potassium amminetrichlorplatinate (II).

Neutral: [Co(NH₃)₃Cl₃]⁰ trichlorotriamminecobalt; [Fe⁰(CO)₅]⁰ pentacarbonyl iron.

II. This classification of complex compounds is based on the nature of ligands.

Acidocomplexes. As ligands are the acid residua Cl⁻ (chloro); CN⁻ (cyano); CNS⁻ (rhodanic); NO₂⁻ (nitro); SO₄²⁻ (sulphate) and so on.

Aminocomplexes (ammines). As ligands are the ammonia molecules: [Cu(NH₃)₄]SO₄; [Cr(NH₃)₆]Cl₃; [Pt(NH₃)₆]Cl₄.

Aquacomplexes. As ligands are the molecules of water: [Co(H₂O)₆]Cl₂; [Cr(H₂O)₆]Cl₃.

Hydroxocomplexes. As ligands are hydroxide ions OH⁻:



Carbonyl complexes. In *carbonyl* complexes CO-ligands are covalently bonded with the help of carbon atom with the metal having zero oxidation number: [Ni(CO)₄]; [Fe(CO)₅].

Dissociation of complex compounds in solutions. The inner and the outer spheres of a complex compound differ greatly according to the stability.

Particles, situated in the outer sphere, are bound with a complex ion by electrostatic forces and can easily dissociate in water solution. Ligands, situated in the inner sphere, are more firmly bonded with the central atom and dissociate to a smaller extent. That's why the dissociation of complex compounds has two stages. At the first stage the dissociation occurs as the dissociation of strong electrolytes:

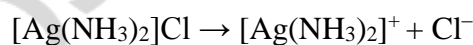

At the second stage the dissociation occurs as the one of weak electrolytes, it's reversible and partial:

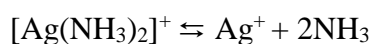

The ion dissociation [Ag(NH₃)₂]⁺ like the dissociation of any weak electrolyte is expressed by the constant of chemical equilibrium:

$$K_{\text{ch.e.}} = \frac{[\text{Ag}^+][\text{NH}_3]^2}{[[\text{Ag}(\text{NH}_3)_2]^+]} = K_i$$

The constant of chemical equilibrium $K_{\text{ch.e.}}$ in case of the dissociation of a complex ion is called *the constant of instability* K_i . It characterizes the stability of the inner sphere of complex compounds. **The less is K_i** , the less is the concentration of decay products of the complex and *the more stable is the complex*.

To characterize the stability of complex compounds you can use the value inverse to the constant of instability which is called the *constant of stability* K_s .

$$K_s = \frac{1}{K_i} = \frac{[[\text{Ag}(\text{NH}_3)_2]^+]}{[\text{Ag}^+][\text{NH}_3]^2}$$

The greater is K_s , the more stable is the complex.

Destruction of complex compounds. To destroy a complex you should shift the equilibrium of dissociation of the inner sphere to the right. This can be achieved by the formation of a more stable complex, an almost insoluble precipitate, a weak electrolyte or a gaseous product. For example, the equilibrium of ion dissociation $[\text{Ag}(\text{NH}_3)_2]^+$ can be shifted to the right by binding of Ag^+ or NH_3 :

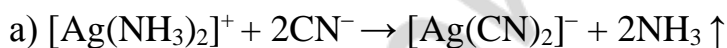
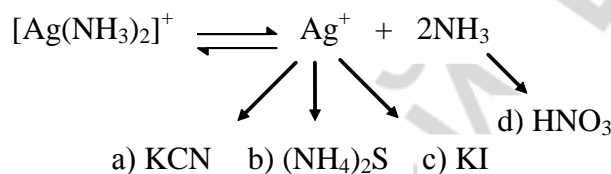

$$K_i. [\text{Ag}(\text{CN})_2]^- = 1 \cdot 10^{-21} < K_i. [\text{Ag}(\text{NH}_3)_2]^+ = 6,8 \cdot 10^{-8}$$

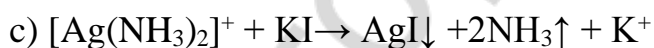

Equilibria and the processes in solutions with complex compounds.

In a human body there is a constant process of destruction and formation of biocomplexes from the cations of biometals (iron, copper, zinc, cobalt) and bioligands (porphyrins, aminoacids, proteins, polypeptides, nucleic acids, ATP). The study of the processes taking place in the organism to form complex compounds can be of great importance for prevention and treatment of a number of diseases. For example, chelators such as polyaminocarboxylic acids and their salts are widely used for the excretion of ions of toxic metals from the organism. In medicine there is a special trend connected with the usage of complexons which is called *chelation therapy*. The disodium salt of ethylenediaminetetraacetic acid (EDTA or complexon III, trade name trilon B) has got a wide distribution.

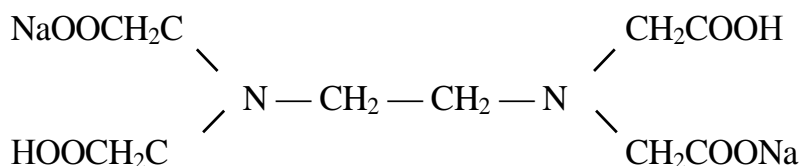

With the help of this salt it's possible to increase the excretion of ions of toxic metals such as lead, mercury, cadmium and barium and others from the organism. The formed complex compounds are soluble in water, are not degraded in biological medium and can be easily excreted through the kidneys. The ability to form stable complex compounds with many metals can be seen in many other calcium and cobalt salts of EDTA. For example, calcium salt is widely used in cases of poisoning with lead.

Proteins are polydentate ligands and can easily combine with heavy metals. When poisoned with the salts of heavy metals the patient is given some milk and fresh eggs which contain lots of proteins. The formed complex compounds aren't absorbed by the blood of the intestine and heavy metals are excreted in such a way.

Vitally important elements Zn, Cu, Fe, Mn, Co, Mo are part of some enzymes called metalloenzymes. The most well-known are carbonic anhydrase, xanthine oxidase, cytochromes which have zinc, molybdenum and iron in their active centers. Ligands in metalloenzymes are the proteins and their central atoms are the ions of metals.

CHAPTER 8

Heterogeneous Equilibria

Heterogeneous equilibria are the equilibria in the heterogeneous systems. Heterogeneous systems consist of several phases separated by real physical borders of phase divisions. The examples of these systems are gas-liquid, solid-liquid, solid-gas. Heterogeneous systems are always multiphase. *Phase* is a part of a system with identical chemical and physical properties.

The solubility constants. Let's consider a heterogeneous system which consists of a slightly soluble precipitate of a strong electrolyte and a saturated solution over it when they both are in dynamic chemical equilibrium. When the precipitate (e. g. BaSO_4) contacts with water there are two processes in this system:

1) dissolution when polar water molecules transfer a part of ions from the ionic lattice of BaSO_4 into a liquid phase;

2) precipitation when under the influence of electrostatic field of BaSO_4 lattice a part of Ba^{2+} and SO_4^{2-} ions transfers from its liquid phase into a solid one building up the lattice of the salt.

With time the dissolution rate will become equal to the precipitation rate and there will be the dynamic equilibrium between the crystalline precipitate of slightly soluble salt BaSO₄ and its water solution containing Ba²⁺ (aq) and SO₄²⁻ (aq) ions:

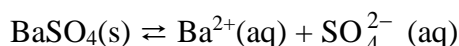

The solution being in the equilibrium with a solid phase which consists of BaSO₄ is called *saturated with respect to the precipitate*. Such a solution is the equilibrium heterogeneous system.

Let's apply the law of mass action to this equilibrium heterogeneous process. As BaSO₄ is a slightly soluble strong electrolyte, we'll use the apparent concentration (activity):

$$K_{\text{ch. e.}} = \frac{a_{\text{Ba}^{2+}(\text{aq})} \cdot a_{\text{SO}_4^{2-}(\text{aq})}}{a_{\text{BaSO}_4(\text{s})}}$$

In chemistry the activity **a** of a solid phase is taken as 1 and it is a constant. The product of these two constants gives a new constant called *the thermodynamic solubility constant and denoted by K_s⁰*:

$$a_{\text{BaSO}_4} = 1; \text{ then } K_{\text{ch. e.}} \cdot a_{\text{BaSO}_4(\text{s})} = a_{\text{Ba}^{2+}(\text{aq})} \cdot a_{\text{SO}_4^{2-}(\text{aq})};$$

$$K_s^0$$

$$\text{i. e. } K_s^0 = a_{\text{Ba}^{2+}(\text{aq})} \cdot a_{\text{SO}_4^{2-}(\text{aq})}$$

So, in a saturated solution of a slightly soluble strong electrolyte the product of the equilibrium ion activities is a constant at a given temperature.

The solution being in the equilibrium with BaSO₄ precipitate is called saturated but strongly diluted. *In saturated solutions of strong electrolytes the activity coefficient is f_a → 1 and a → C. In this case ion activities can be substituted by their molar concentrations and the thermodynamic solubility constant K_s⁰ will become the concentration solubility constant K_s:*

$$K_s = C(\text{Ba}^{2+}) \cdot C(\text{SO}_4^{2-}),$$

where C is the equilibrium anion and cation concentrations (mol/L) in a saturated solution of a strong electrolyte.

The molar concentrations of the ions involved in the equilibrium each raised to the power of its stoichiometric coefficient in the balanced equilibrium equation.

If a slightly soluble strong electrolyte forms several ions when dissociated, the ion activities (concentrations) in appropriate degrees are included into the equations K_s⁰ and K_s.

Examples:

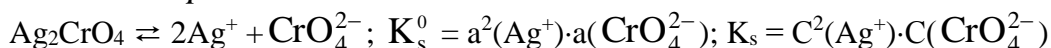

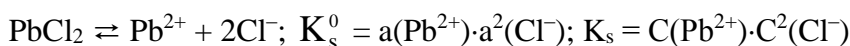

In general the thermodynamic and the concentration solubility constants for the reaction: $A_m B_n (s) \rightleftharpoons m A^{n+} (aq) + n B^{m-} (aq)$ can be written as follows: $K_s^0 = a^m(A^{n+}) \cdot a^n(B^{m-}); K_s = C^m(A^{n+}) \cdot C^n(B^{m-})$

To simplify the calculations we can use the concentration solubility constant K_s taking $f_a = 1$ and $K_s = K_s^0$.

Interconnection between solubility and K_s^0 . The solubility of different substances is quantitatively expressed by the concentration of saturated solutions. So, *the solubility of a given substance is equal to its molar concentration in the saturated solution (molar solubility of a substance): S (mol/L).* Solubility can also be expressed in grams of a solute per 100 gram of a solvent or in grams of a solute per 1 L of the solution.

Solubility of solids depends on the nature of solute, solvent, temperature and so on.

The connection between the value K_s^0 and the solubility depends on the amount of ions which are the result of dissociation of a slightly soluble strong electrolyte in the solution. Let's consider some examples of how to calculate the molar solubility of a slightly soluble strong electrolyte using its value K_s taking into account that $K_s^0 = K_s$:

a) binary electrolyte:

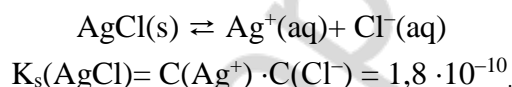

In the state of equilibrium in accordance with the reaction condition:

$$C(\text{Ag}^+) = C(\text{Cl}^-) = S(\text{AgCl}).$$

Let's express the value K_s of the salt in terms of the value of its solubility:

$$K_s(\text{AgCl}) = S^2(\text{AgCl}),$$

consequently:

$$S(\text{AgCl}) = \sqrt{K_s(\text{AgCl})} = \sqrt{1,8 \cdot 10^{-10}} = 1,3 \cdot 10^{-5} \text{ (mol/L)}.$$

b) three-ion electrolyte:

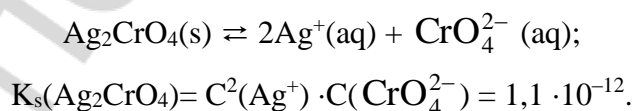

In the state of equilibrium in accordance with the reaction condition:

$$C(\text{CrO}_4^{2-}) = S(\text{Ag}_2\text{CrO}_4);$$

$$C(\text{Ag}^+) = 2S(\text{Ag}_2\text{CrO}_4).$$

Let's express the value K_s of the salt in terms of the value of its solubility:

$$K_s(\text{Ag}_2\text{CrO}_4) = (2S)^2 \cdot S = 4S^3(\text{Ag}_2\text{CrO}_4),$$

consequently:

$$S(\text{Ag}_2\text{CrO}_4) = \sqrt[3]{\frac{K_s(\text{Ag}_2\text{CrO}_4)}{4}} = \sqrt[3]{\frac{1,1 \cdot 10^{-12}}{4}} = 6,5 \cdot 10^{-5} \text{ (mol/L)}.$$

In general, the dependence between K_s and S of a slightly soluble strong electrolyte of type A_mB_n can be expressed by the following equation:

$$S(A_mB_n) = \sqrt[m+n]{\frac{K_s(A_mB_n)}{m^m \cdot n^n}}$$

Comparing the value K_s^0 of single-type electrolytes (when dissolved, 1 mole of different slightly soluble strong electrolytes forms the same number of mole ions) it's possible to estimate qualitatively the solubility of precipitates.

Precipitate	$K_s^0 \times (25^\circ\text{C})$	
AgCl	$1,8 \times 10^{-10}$	Among the mentioned silver halogenides, AgI is the least soluble and AgCl is the most soluble.
AgBr	$5,3 \times 10^{-13}$	
AgI	$8,3 \times 10^{-17}$	

Less the K_s^0 – less the solubility S of single-type electrolytes ($K_s^0 \approx K_s$).

Conditions of formation and solubilization of precipitates. When ion concentration in the solution is known, we can suppose the direction of the heterogeneous process.

Let's imagine that we have an equilibrium heterogeneous system:

$\text{AgCl} \rightleftharpoons \text{Ag}^+ + \text{Cl}^-$. In this system the solution will be saturated only if $C(\text{Ag}^+) \cdot C(\text{Cl}^-) = K_s$. In the other case the solution will not be saturated.

If $C(\text{Ag}^+) \cdot C(\text{Cl}^-) < K_s$ we can observe the dissolution of the precipitate or the equilibrium shift to the right in this heterogeneous system.

AgCl will precipitate when $C(\text{Ag}^+) \cdot C(\text{Cl}^-) > K_s$. So, the precipitate will fall out only in this case when the product of ion concentration of a slightly soluble strong electrolyte will be greater than the value of concentration solubility constant K_s .

So, the precipitation is a successive process which can be divided into 3 main stages:

- 1) appearance of nucleus of crystallization;
- 2) growth of crystals from the nucleus;
- 3) aggregation of crystals with the formation of polycrystalline precipitate.

These stages occur at different rates. That's why when $C(\text{Ag}^+) \cdot C(\text{Cl}^-) > K_s$ the precipitate of silver chloride is not always formed. The last stage can last for several hours or even days.

The following generalizations can be made regarding the relative values of K_s^0 and the reaction ion activities product:

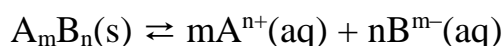

$$K_s^0 \text{Ca}_3(\text{PO}_4)_2 = 2 \times 10^{-29}, K_s^0 \text{Ca}_5(\text{PO}_4)_3\text{OH} = 1,6 \times 10^{-58}.$$

It goes without saying that the processes of calcium phosphate precipitation which are the basis for the bone tissue formation are much more complex.

Blood plasma is an almost saturated solution of calcium hydroxide phosphate CaHPO_4 which is in dynamic equilibrium with inorganic constituent parts of bone tissue. If the product of ion Ca^{2+} and HPO_4^{2-} concentrations is increased in the blood, there is the calcification and if it decreases, the content of inorganic components in bones is decreased too.

When the Ca^{2+} ion concentration in blood plasma is increased we can observe the equilibrium shift which leads to calcium deposition in bone tissue. And on the contrary, the decrease in Ca^{2+} ion concentration in blood plasma also causes the equilibrium shift but now accompanied by the dissolution of mineral components of bone tissue. For example, in the case of rickets when there is insufficient adsorption of Ca^{2+} ions from the gastrointestinal tract their concentration in blood plasma remains constant due to the release of Ca^{2+} ions from the inorganic components of bones.

Due to such a phenomenon as isomorphism together with calcium salts there is also the precipitation of cations of other salts like beryllium, strontium and barium salts similar to calcium ions in their properties.

The presence of even small amounts of beryllium in the environment leads to such a disease called berylliosis (beryllium rickets). The thing is that Be^{2+} ions displace Ca^{2+} ions from bone tissue causing osteomalacia.

Strontium ions form insoluble compounds with the same anions as calcium ions. Part of strontium ions Sr^{2+} is also a part of bone tissue. The excess of strontium ions causes bone fragility (strontium rickets). But of the greatest danger can be radioactive nuclide strontium-90 (period of half-decay is 27,7 years, pure β -emitter). Its sources can be radioactive dust, drinking water, vegetal and diary products. Settling in bones, Sr^{90} irradiates the marrow and breaks (intra)medullary hematosis.

Calcium ions Ca^{2+} together with oxalate ions can form depositions of calcium oxalate or so called oxalate calculus. It is formed in kidneys, bladder, and are the reason of urolithiasis. Besides calcium oxalate, calcium phosphate and calcium urate are also part of calculus.

The main principle in treatment of urolithiasis is the calcium extraction from concrements with its further transfer into the form of soluble compounds. The most widely used method of such extraction is the influence on the calculus by some complex formers interacting with ions of bivalent metals which are part of the calculus (chelation therapy). These can be ethylenediaminetetraacetic acid and its salts, citric acid and its salts.

CHAPTER 9

Electrochemistry

The interconnection of chemical and electrical phenomena is studied by electrochemistry. The birth of electrochemistry as a science is connected with such names as L. Galvani, A. Volt, V. Petrov and later with the names of G. Davy (discovery of electrolysis), M. Faraday (laws of electrolysis), S. Arrhenius (theory of electrolytic dissociation). The date of birth of electrochemistry is 1791 when L. Galvani making a preparation of frogs discovered «living» electricity.

In the middle of the 20th century as a result of interaction of biology and electrochemistry a new science, bioelectrochemistry, studying the electrochemical bases of functioning of living systems was born. The main matters of bioelectrochemical study are biological membranes.

The internal environment of people and animals possesses ionic conductivity. Both organic and inorganic ions participate in the electric current conductivity. Biological fluids and tissues containing relatively high concentrations of highly mobile ions are the best conductors of electricity, e. g. blood, lymph, muscular tissue. Poor conductors of electricity are neural [nerve] tissues, skin, and sinews. Bone [osseous] tissue is a dielectric.

Electrical conduction of skin and internal organs can be changed depending on different pathological states. For example, electric conduction can decrease when some inflammatory process takes place. This drastic decrease can be accompanied by converting of healthy cells into timorous ones. It's important for diagnosis.

All conductors of electricity are divided into 2 types: the first and the second. The conductors of the first type are electronic ones, i. e. the conductors where electrons are the charge (electric current) carriers. They are usually metals. The conductors of the second type are ionic ones, i. e. the conductors where ions are the charge carriers. They are usually electrolytes, i. e. substances which conduct electricity in solutions or fluxes.

All body tissues are impregnated and washed by biological fluids with strong or weak electrolytes dissolved in them. That's why such biological fluids as blood, lymph, cerebrospinal fluid, lachrymal fluid, saliva are considered to be the conductors of the second type.

9.1. ABSOLUTE ION MOVEMENT RATE

In electrolytic solutions solvated ions are in random motion. When the electric field is applied, the ordered ion movement to the oppositely charged electrodes can be observed.

The comparison of movement rates of different kinds of ions can be done with the help of the gradient of field potential 1V/m. In this case the movement

rate of ions called the absolute rate is indicated by the letter ω and is expressed in $\text{m}^2 \cdot \text{V}^{-1} \cdot \text{sec}^{-1}$. The absolute movement rate of ions is the distance in meters which an ion can overcome in 1sec with the gradient of field potential equal 1V/m. The numeric values of absolute ion movement rates in the given solvent depend only on their nature and temperature.

To estimate the ability of ions to move under the influence of the external field we can also use such a quantitative characteristic as ionic mobility (U). Ionic mobility is a product of Faraday's number and the absolute ion movement rate and it is expressed in $\text{Sm} \cdot \text{m}^2 \cdot \text{mol}^{-1}$: $U = F \cdot \omega$.

The values of absolute ion movement rates and ionic mobilities at 25 °C are shown in table 9.1.

Table 9.1

Absolute ion movement rate and ionic mobility at 25 °C

Cation	ω $\text{m}^2 \cdot \text{V}^{-1} \cdot \text{s}^{-1}$	U $\text{Sm} \cdot \text{m}^2 \cdot \text{mol}^{-1}$	Anion	ω $\text{m}^2 \cdot \text{V}^{-1} \cdot \text{s}^{-1}$	U $\text{Sm} \cdot \text{m}^2 \cdot \text{mol}^{-1}$
H ⁺	$36,3 \times 10^{-8}$	$349,9 \times 10^{-4}$	OH ⁻	$20,6 \times 10^{-8}$	$199,2 \times 10^{-4}$
Li ⁺	$4,0 \times 10^{-8}$	$38,7 \times 10^{-4}$	F ⁻	$5,7 \times 10^{-8}$	$55,4 \times 10^{-4}$
Na ⁺	$5,2 \times 10^{-8}$	$50,3 \times 10^{-4}$	Cl ⁻	$7,9 \times 10^{-8}$	$76,3 \times 10^{-4}$
K ⁺	$7,6 \times 10^{-8}$	$73,5 \times 10^{-4}$	Br ⁻	$8,1 \times 10^{-8}$	$78,4 \times 10^{-4}$
Rb	$8,0 \times 10^{-8}$	$77,5 \times 10^{-4}$	I ⁻	$8,0 \times 10^{-8}$	$76,9 \times 10^{-4}$
Cs ⁺	$8,0 \times 10^{-8}$	$77,5 \times 10^{-4}$	NO ₃ ⁻	$7,4 \times 10^{-8}$	$71,5 \times 10^{-4}$
NH ₄ ²⁺	$7,6 \times 10^{-8}$	$73,5 \times 10^{-4}$	CH ₃ COO ⁻	$4,2 \times 10^{-8}$	$40,9 \times 10^{-4}$
Mg ²⁺	$5,5 \times 10^{-8}$	$106,1 \times 10^{-4}$	CO ₃ ²⁻	$7,2 \times 10^{-8}$	$138,6 \times 10^{-4}$
Al ³⁺	$6,5 \times 10^{-8}$	$183,2 \times 10^{-4}$	SO ₄ ²⁻	$8,3 \times 10^{-8}$	$159,6 \times 10^{-4}$

In the electric field of electrolytic aqueous solutions it is not the free ion that is mixed up but the ion with a hydrated shell tightly linked with it. Among cations, lithium cation Li⁺ has the smallest size, hence its hydration is the highest and it is characterized by the least absolute movement rate. Ions Na⁺, Mg²⁺, Al³⁺ having approximately the same size exhibit slight increase in absolute movement rate with the increase of ionic charge because their hydrated shells drastically increase. The hydroxonium H₃O⁺ ions and hydroxide ions possess the highest absolute movement rate. This fact can be explained with the help of so-called 'relay race mechanism' of transferring of these ions. In a chain built of water molecules the charge can move from one end to the other one in the result of a slight transfer of protons forming hydrogen bonds between water molecules, for example:

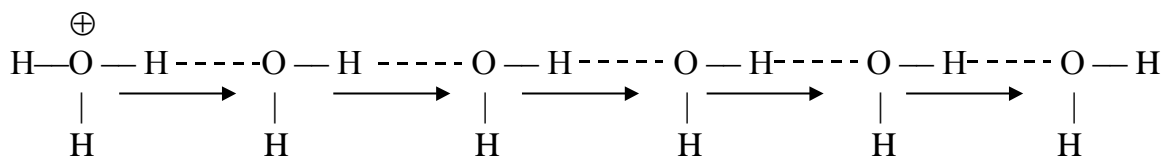

This scheme shows that the transfer of electric charge occurs without the transfer of hydrogen atoms. In other words, instead of one H^+ ion moving in the solution there is an effective movement of H^+ ion which includes the formation and the bond opening along the long chain of water molecules. The analogous scheme can be drawn for the hydroxide ion.

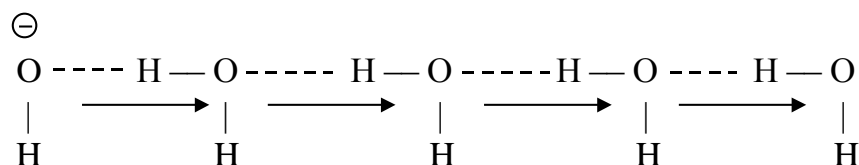

The increase in temperature influences the absolute ion movement rate by dehydration and decrease in viscosity medium which helps to increase ion transfer rate.

9.2. SPECIFIC ELECTRICAL CONDUCTIVITY

Electrical conductivity (L) is the ability of a substance to conduct electricity under the influence of the electric field. It is the reciprocal value to the electrical resistance R : $L = \frac{1}{R}$

SI unit of electrical conductivity is Siemens (Sm) and $1\text{Sm} = 1\text{ohm}^{-1}$. It is known that $R = \rho \frac{l}{S}$. So, $L = \frac{1}{R} = \frac{1}{\rho} \cdot \frac{S}{l}$, as $\frac{1}{\rho} = \kappa$, then: $L = \kappa \cdot \frac{S}{l}$,

where κ (kappa) is specific electrical conductivity (Sm/m), ρ is specific electrical resistance, S is the area of flat electrodes (m^2) with the solution contained between them, l is the distance between the electrodes (m).

Specific electrical conductivity is the electrical conductivity of 1m^3 of a solution situated in the homogeneous electrical field with the strength of 1V/m . SI unit

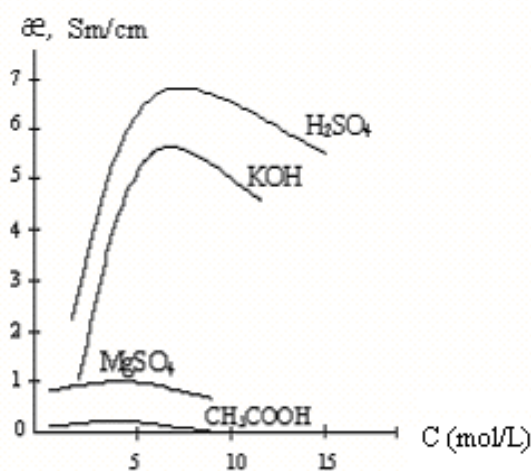

Fig. 9.1. Dependence of specific electrical conductivity on the solution concentration for some electrolytes

of specific electrical conductivity is Siemens/meter (Sm/m). Specific electrical conductivity depends on many factors and, first of all, on the nature of electrolyte, its concentration and temperature. Fig. 9.1 shows the isotherms of specific electrical conductivity.

Analysis of these isotherms helps to make several conclusions:

1. Specific electrical conductivity is a maximum

for the solutions of strong acids and a little less for strong bases, which can be explained by complete dissociation of these electrolytes and high mobility of ions H_3O^+ и OH^- .

2. Specific electrical conductivity of weak electrolytic solutions (CH_3COOH) has the smallest values in the whole range of concentrations because of low concentration of ions ($\alpha \ll 1$)

3. Specific electrical conductivity increases with the increase in concentration of electrolyte to some maximum values because of the increase of number of ions in the unit of solution volume. Having reached the maximum, specific electrical conductivity starts decreasing despite the increase in concentration of electrolyte. Such dependence κ on C at strong electrolytes can be explained by the decrease in ion mobility and at weak electrolytes — by the degree of electrolytic dissociation of the electrolyte.

With the increase in temperature specific electrical conductivity is increased too. It is explained by dehydration of ions and the decrease in viscosity medium, i.e. the decrease in resistance to ion movements.

Specific electrical conductivity depends also on dilution. Dilution is the reciprocal value to concentration. (Dilution is expressed by the letter V or $1/C$ and characterizes the volume of the solution containing 1 mole of electrolyte). When the dilution is low, the solution is concentrated and the degree of weak electrolyte dissociation is small. With the dilution increase α increases too and consequently so does specific electrical conductivity. With further dilution increase the dissociation degree approaches to 1 and stops here while the general amount of electrolyte in the unit of volume decreases causing the drop in electrical conductivity.

Specific electrical conductivity can be calculated theoretically:

$$\kappa = F \cdot C \cdot \alpha \cdot (\omega_{\text{an}} + \omega_{\text{cat}}) \text{ for weak electrolytes}$$

$$\kappa = F \cdot C \cdot f_a \cdot (\omega_{\text{an}} + \omega_{\text{cat}}) \text{ for strong electrolytes}$$

where F – Faraday's number, C – concentration of electrolyte (mol/m^3), α – the dissociation degree of a weak electrolyte, f_a – activity coefficient of a strong electrolyte, ω_A и ω_K – absolute movement rate of anion and cation in m/sec at gradient of potential of 1 V/m .

9.3. MOLAR ELECTRICAL CONDUCTIVITY

Molar electrical conductivity is the conductivity of 1 mole of electrolyte contained in the solution between two parallel electrodes with the distance of 1 meter between them and the gradient of potential of 1 V/m . There is the dependence between the specific electrical conductivity and the molar electrical conductivity (λ_m):

$$\lambda_m = \kappa / C,$$

where λ_m (lambda) is molar electrical conductivity, $\text{Sm}\cdot\text{m}^2\cdot\text{mol}^{-1}$, κ is specific electrical conductivity, Sm/m , C is the electrolyte concentration in the solution, mol/m^3 .

Usually, molar concentration is characterized by the amount of substance in 1 dm^3 but not in 1 m^3 . In this case the ratio is the following:

$$\lambda_m = \kappa / 1000 \cdot C$$

Molar electrical conductivity can also be calculated theoretically:

$$\lambda_m = \frac{F \cdot C \cdot \alpha \cdot (\omega_{\text{cat}} + \omega_{\text{an}})}{C} = F \cdot \alpha \cdot (\omega_{\text{an}} + \omega_{\text{cat}}) - \text{for weak electrolytes}$$

$$\lambda_m = \frac{F \cdot C \cdot f_a \cdot (\omega_{\text{cat}} + \omega_{\text{an}})}{C} = F \cdot f_a \cdot (\omega_{\text{an}} + \omega_{\text{cat}}) - \text{for strong electrolytes}$$

The value of molar electrical conductivity when the dilution is infinite is called maximum molar electrical conductivity and is indicated by λ_m^0 (fig. 9.2).

The increase of values λ_m in weak electrolytes is connected with the increase of dissociation degree when diluting the solution ($\alpha \rightarrow 1$ at $C \rightarrow 0$), i.e. it is connected with the increasing amount of ions formed in 1 mole of electrolyte at a given temperature.

In strong electrolytes when the dilution is infinite the ionic interaction is decreasing, absolute movement rate of ions reaches the limiting values and that's why molar electrical conductivity doesn't depend any more on the concentration and becomes a constant.

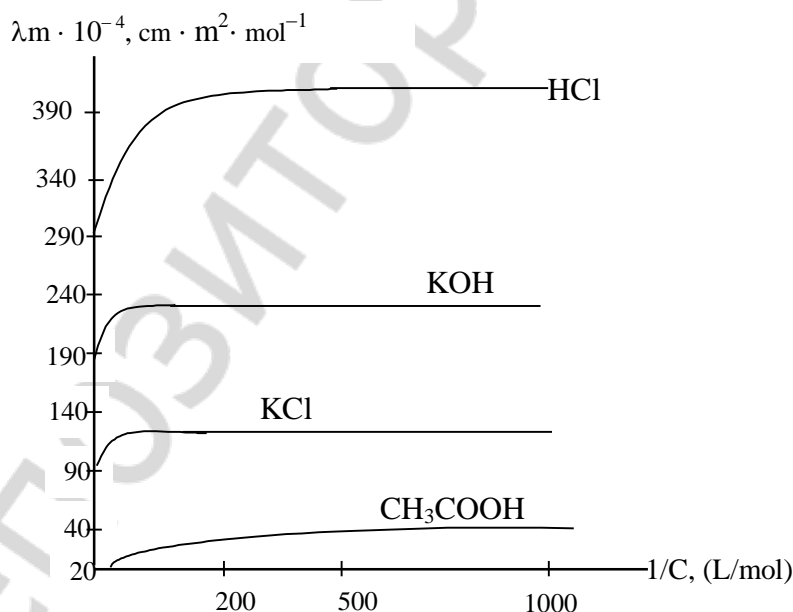

Fig.9. 2. Dependence of the molar electrical conductivity on the solution concentration for some electrolytes.

Molar electrical conductivity at a given dilution λ_m is always less than the value of maximum molar electrical conductivity λ_m^0 . The ratio of these values, i. e. λ_m/λ_m^0 characterizes:

a) degree of dissociation at the given solution concentration for a weak electrolyte $\frac{\lambda_m}{\lambda_m^0} = \alpha$ (Arrhenius ratio);

b) activity coefficient (f_a) at the given concentration for a strong electrolyte $\frac{\lambda_m}{\lambda_m^0} = f_a$.

Let's suppose that at the infinite dilution of weak electrolyte solutions $\alpha \approx 1$ and of strong electrolytes $f_a \approx 1$, hence:

$$\lambda_m^0 = F \cdot (\omega_{an} + \omega_{cat})$$

Consequently, at the infinite dilution of electrolyte solutions their molar electrical conductivity will depend only on absolute ion movement rates to electrodes. As $U = F \cdot \omega$, then $\lambda_m^0 = U_{cat} + U_{an}$

As we can see from the last equation the sum of anion and cation mobility is equal to molar electrical conductivity at the infinite dilution.

The cation mobility U_{cat} can often be denoted by λ_{cat}^0 and is called maximum cation conductivity; the anion mobility U_{an} is denoted by λ_{an}^0 and is called maximum anion conductivity. So the equation will be the following:

$$\lambda_m^0 = \lambda_{cat}^0 + \lambda_{an}^0$$

Consequently, the sum of maximum conductivities of cation and anion will be equal to molar electric conductivity of electrolyte at the infinite dilution.

For example, maximum molar electrical conductivity of acetic acid will be:

$$\lambda_m^0(\text{CH}_3\text{COOH}) = \lambda_m^0(\text{H}^+) + \lambda_m^0(\text{CH}_3\text{COO}^-).$$

9.4. CONDUCTOMETRY

Conductometry is the collection of physical-chemical methods based on the measurements of resistance of the subject matter which are the conductors of the second type.

We can identify electrical conductivity according to the value of the solution resistance to the electric current going between two electrodes immersed into this solution. With the help of conductometry we can determine the concentration of the solute, the constant and the dissociation degree of a weak electrolyte, solubility and product of solubility of almost insoluble substances, ionic product of water and other physicochemical values.

Conductometric determination of the degree and constant of weak electrolyte dissociation.

1. We should determine specific electrical conductivity of a weak electrolyte and calculate molar electrical conductivity at the given dilution:

$$\lambda_m = \kappa / C$$

2. We should calculate molar electrical conductivity at the infinite dilution, i. e. the value of maximum molar electrical conductivity λ_m^0 : $\lambda_m^0 = \lambda_{\text{cat}}^0 + \lambda_{\text{an}}^0$. Maximum molar electrical conductivities of cations λ_{cat}^0 and anions λ_{an}^0 can be found in table 9.2.

Table 9.2

Temperature	Ion mobility $\lambda_{\text{cat}}^0, \lambda_{\text{an}}^0$ ($\text{Sm}\cdot\text{cm}^2\cdot\text{mol}^{-1}$)	
	H^+	CH_3COO^-
18°	315	35
19°	320	35,9
20°	324,8	36,6
21°	329,8	37,4
22°	334,7	38,2
23°	339,7	39,1
24°	345,0	40,1
25°	349,8	40,9

3. For weak electrolytes their dissociation degree (α) can be calculated using the formula:

$$\alpha = \frac{\lambda_m}{\lambda_m^0}$$

4. We should substitute this ratio in the equation of Ostvald's law of dilution:

$$K_{\text{dis.}} = \frac{\alpha^2 C}{1 - \alpha}$$

Thus we get

$$K_{\text{dis.}} = \frac{(\lambda_m / \lambda_m^0)^2 \cdot C}{1 - (\lambda_m / \lambda_m^0)}$$

Conductometric titration. When making the conductometric titration we should measure the electrical conductivity of the solution before the titration and while adding small definite volumes of titrant. The equivalence point is determined by the graphical method with the help of a curve of conductometric titration (fig. 9.3).

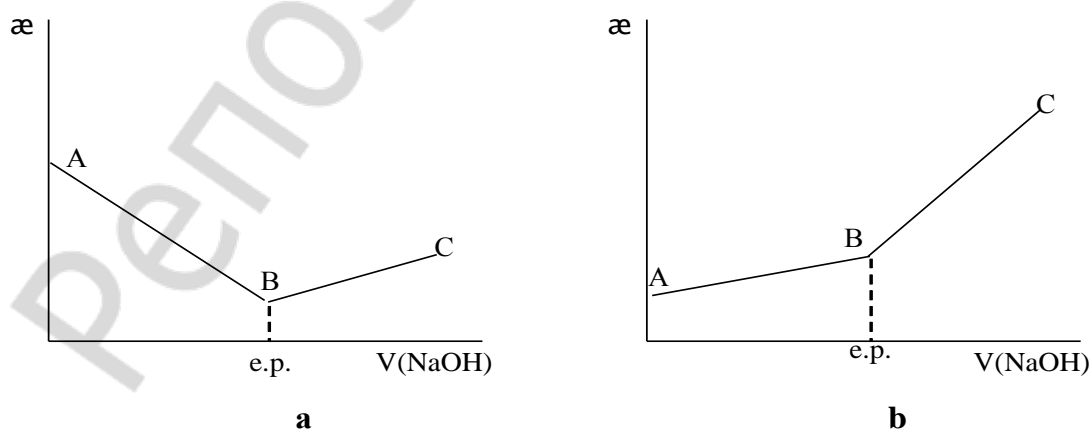

Fig. 9.3. Conductometric titration curves

Fig. 9.3 shows the dependence of specific electric conductivity κ on the volume V of added titrant. When a strong acid is titrated by a strong base (fig. 9.3a) at the titration curve we can find a minimum (the equivalence point) corresponding to the exchange of hydrogen ions by less mobile ions of a formed salt (branch AB):



After the equivalence point we can observe a drastic rise of electrical conductivity (branch BC) because the concentration of ions Na^+ and OH^- will be increased.

When a weak acid is titrated by a strong base (fig.9.3b) the electrical conductivity of the solution will be increased and this can be explained by the significant dissociation of the formed salt in comparison with the dissociation of the initial substance (branch AB):

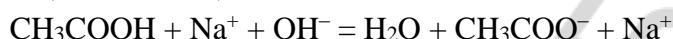

After the equivalence point we can observe a drastic rise of electrical conductivity (branch BC) because the concentration of ions Na^+ and OH^- will be increased.

Conductometric titration is used for the determination of the concentration of coloured, muddy solutions and biological fluids where the colour change indicator is masked.

9.5. THEORY OF ORIGIN OF ELECTRODE AND OXIDATION REDUCTION POTENTIALS

The strength of an oxidizing agent and a reducing agent depends on the ability to gain or lose electrons. This ability is characterized by the value of a standard electrode or standard OR-potential.

When a metallic plate is immersed into a solution of its own salt, two main processes take place. The first process is the ionization of the plate metal where there are ions – atoms in the nodes of the lattice: $\text{Me} \rightleftharpoons \text{Me}^{n+} + \text{ne}^-$

Ionization takes place under the influence of polar molecules of a solvent (water). The formed electrons are concentrated on the plate, giving it a negative charge. The formed cations of a metal move from the plate into the solution and are concentrated near the plate (fig. 9.4).

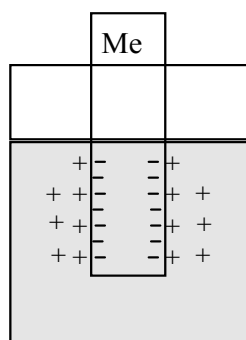
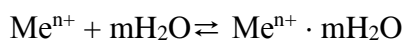

Fig.9.4. Double electric layer at the interface 'metal-solution'

The second process is the interaction of molecules of the solvent and the ions of the metal, i. e. solvation of the formed ions:



When a metallic plate is immersed into a solution, the process of metal ionization is at first prevailing:



but in the course of time the rate of the direct reaction decreases while the rate of the reverse reaction increases:

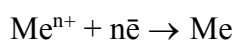

till the moment when there is a dynamic equilibrium between these processes:



or in a more simple way:



At the same time at the interface 'metal-solution' (solid phase-liquid) there appears an equilibrium double electric layer (DEL) which consists of positive ions and electrons. There is a sudden change of potential, called electrode potential between positive ions and electrons. The potential appearing under the conditions of electrode reaction equilibrium is called the equilibrium electrode potential. Symbolic notation of the system «metal-solution» is Me/Me^{n+} and the border of division «solid phase-liquid» is marked by a vertical line. The system with the metal immersed into a solution of its own salt is called electrode or half-element. The value of the electrode potential at the border «metal-solution» depends on the nature of a metal, its ion activity and temperature.

The values of electrode potentials can be calculated using Nernst's equation:

$$\varphi_{\text{Me}^{n+}/\text{Me}} = \varphi^0_{\text{Me}^{n+}/\text{Me}} + \frac{RT}{nF} \ln a_{\text{Me}^{n+}},$$

where $\varphi^0_{\text{Me}^{n+}/\text{Me}}$ is a standard electrode potential, measured under standard conditions (25°C or 298K at $a_{\text{Me}^{n+}} = 1\text{mol/L}$), $R = 8,314\text{ J/mol}\cdot\text{K}$, universal gas constant, T – temperature on the Kelvin scale, F – Faraday's number, which equals 96500 C/mol , n – number of electrons, lost by a metal ion when a cation is formed, a – activity of cation Me^{n+} (mol/L).

If we introduce the numerical values of constants and switch from natural logarithms to common ones, Nernst's equation at standard temperature of 298K will be the following:

$$\varphi_{\text{Me}^{n+}/\text{Me}} = \varphi^0_{\text{Me}^{n+}/\text{Me}} + \frac{0,059}{n} \ln a_{\text{Me}^{n+}}$$

The value of electrode potential depends also on the charge of cation in the solution. For example, the iron electrode potential in the solution of iron (III)

chloride FeCl_3 will be greater than that of the same electrode in the solution of iron (II) chloride FeCl_2 .

9.6. GALVANIC CELLS

Galvanic cell (chemical current source) is a device where the energy of redox reaction is converted into the electric one. A galvanic cell consists of two electrodes (half-elements). There is a contact between the solutions of separate electrodes which is established with the help of electrolytic bridge filled with the saturated solution of KCl (saline bridge) or with the help of a membrane. They provide electric conductivity between the solutions but prevent them from inter-diffusion and together with electrodes are the inner circuit of a galvanic cell. The outer circuit of a galvanic cell is the electrode ends. The transfer of electrons from one metal to the other occurs on the outer circuit.

We should distinguish chemical (biometallic) and concentration galvanic cells.

Chemical galvanic cells consist of two metals, immersed into the solutions of their own salts. The example of a chemical galvanic cell is Jacoby-Daniell galvanic cell (fig. 9.5).

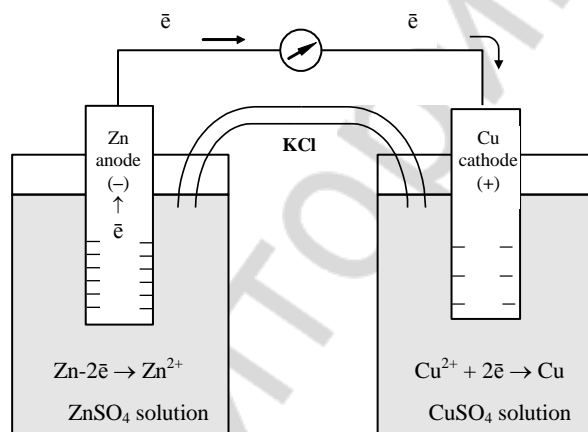
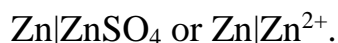

Fig. 9.5. Jacobi-Daniell galvanic cell

It consists of a copper electrode (i.e. a copper plate immersed into the solution of CuSO_4) and a zinc electrode (a zinc plate immersed into the solution of ZnSO_4). So DEL appears on the surface of zinc plate and there is an equilibrium $\text{Zn} \rightleftharpoons \text{Zn}^{2+} + 2\bar{e}$. Thereby, the electrode potential of zinc appears too. The scheme of the electrode will be like that:



Similarly, DEL appears on copper plate and there is an equilibrium $\text{Cu} \rightleftharpoons \text{Cu}^{2+} + 2\bar{e}$. The electrode potential of copper appears. And the scheme of the electrode will be like that: $\text{Cu}|\text{CuSO}_4$ or $\text{Cu}|\text{Cu}^{2+}$. Connected by a saline bridge or a membrane but disconnected in the outer circuit, both electrodes (a

galvanic cell) can remain unchanged for a long time. But when the circuit is closed, some thermodynamic irreversible processes begin to take place. The oxidation process takes place on Zn-electrode (as a more electrochemically active one):

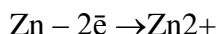

The oxidation processes in electrochemistry are called anode processes and electrodes, where these oxidation processes take place, are called anodes. The reduction process takes place on Cu-electrode (a less electrochemically active one):

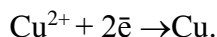

The reduction processes in electrochemistry are called cathode processes and electrodes, where these reduction processes take place, are called cathodes.

At the same time electrons, formed on the anode, move to the cathode along the outer circuit. The movement of ions in the solution closes the electric circuit of a galvanic cell.

Sum equation of electrochemical reaction is the following:

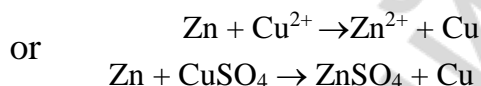

As a result of this chemical reaction in a galvanic cell there is a movement of electrons in the outer circuit and ions in the inner circuit, i. e. the electric current appears.

The scheme of a galvanic cell is written according to the «right plus» rule, i. e. the electrode which is a cathode (+) is written on the right and it's a less active metal. That's why Jacobi-Daniell scheme will look like that:

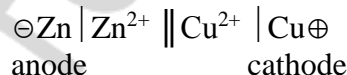

The double vertical line means an electrolytic contact between the electrodes which is realized by means of a saline bridge. It prevents the electrolytes from mixing and provides the flow of electric current in the inner circuit of the element.

In a galvanic cell an electromotive force (EMF) equal to two electrode potential difference arises between two electrodes. The electromotive force of a galvanic element is a constant positive value and it's calculated using the formula:

$$E = \varphi_{\text{cathode}} - \varphi_{\text{anode}}, \text{ where } \varphi_{\text{cathode}} > \varphi_{\text{anode}}.$$

Hence, EMF of copper-zinc galvanic cell is equal to:

$$E = \varphi_{\text{Cu}^{2+}/\text{Cu}} - \varphi_{\text{Zn}^{2+}/\text{Zn}} = \varphi^0_{\text{Cu}^{2+}/\text{Cu}} + \frac{RT}{nF} \ln a_{\text{Cu}^{2+}} - (\varphi^0_{\text{Zn}^{2+}/\text{Zn}} + \frac{RT}{nF} \ln a_{\text{Zn}^{2+}})$$

or

$$E = \varphi_{\text{Cu}^{2+}/\text{Cu}} - \varphi_{\text{Zn}^{2+}/\text{Zn}} = \varphi^0_{\text{Cu}^{2+}/\text{Cu}} + \frac{0,059}{n} \lg a_{\text{Cu}^{2+}} - (\varphi^0_{\text{Zn}^{2+}/\text{Zn}} + \frac{0,059}{n} \lg a_{\text{Zn}^{2+}})$$

If we insert the values of the standard electrode potentials of zinc ($\varphi^0_{\text{Zn}^{2+}/\text{Zn}} = -0,76 \text{ V}$) and copper ($\varphi^0_{\text{Cu}^{2+}/\text{Cu}} = +0,34 \text{ V}$) in this equation, we'll get the equation which helps us calculate EMF of zinc-copper galvanic cell in the solution of their own salts:

$$E = 1,1 + \frac{0,059}{n} \lg \frac{a_{\text{Cu}^{2+}}}{a_{\text{Zn}^{2+}}}$$

Galvanic cell can be the source of current until the whole zinc electrode (anode) is dissolved or until cations Cu^{2+} , discharged at the cathode, are used up.

Concentration galvanic cells consist of two identical electrodes (e.g. silver ones) immersed into the solutions of the same electrolyte (e.g. AgNO_3) but of different concentration. The source of electric current in such an element is the action on electrolyte transfer from a more concentrated solution into a less concentrated one. The element acts this way until the anode and cathode cation concentrations are equal. Concentration galvanic cell can be sketched in the following way:

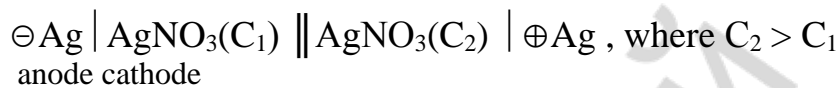

To calculate EMF of concentration galvanic cells we can use the following equation:

$$E = \varphi_c - \varphi_a = \varphi^0_{\text{Ag}^+/\text{Ag}} + \frac{RT}{nF} \ln a_2 - (\varphi^0_{\text{Ag}^+/\text{Ag}} + \frac{RT}{nF} \ln a_1)$$

hence, $E = \frac{RT}{nF} \ln \frac{a_2}{a_1}$ where $a_2 > a_1$.

Activity ratio of diluted solutions is nearly 1, so we can use concentration of solutions instead of their activity.

9.7. STANDARD HYDROGEN ELECTRODE

Absolute value of electrode potential can't be measured or calculated at present. But it's possible to determine the value of electrode potential relative to some electrode taken as a standard. According to the international agreement such a standard is the standard (normal) hydrogen electrode with its potential taken as 0.

$$\varphi^0_{2\text{H}^+/\text{H}_2} = 0,0\text{V}.$$

Standard hydrogen electrode (fig. 9.6) is a platinum plate covered with platinum black and immersed into the solution of H_2SO_4 or HCl with $a_{\text{H}^+} = 1 \text{ mol/L}$ and with gaseous H_2 constantly passed through it under pressure of 101,3 kPa at 298K. Platinum which is distinguished for its high chemical stability is almost unable to send its ions into the solution and doesn't participate in the electrode process. It only absorbs hydrogen from its surface and transfers electrons. Symbolic notation of standard hydrogen electrode is

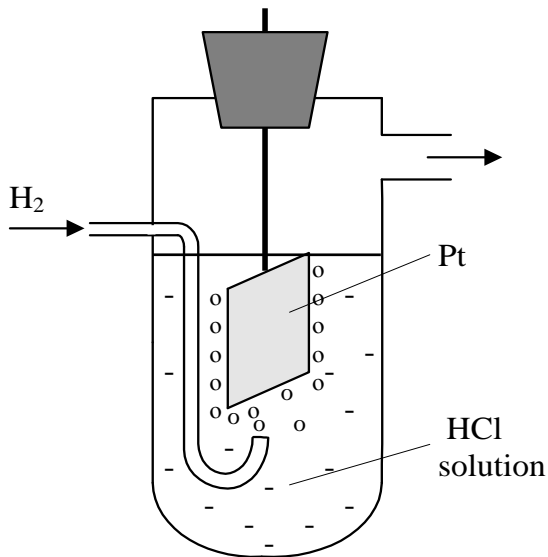

Fig.9. 6. Standard hydrogen electrode

the following: $(\text{Pt})\text{H}_2 | 2\text{H}^+$. At the surface of platinum the following process takes place:



If a plate of any metal is joined with standard hydrogen electrode, we get the value of standard electrode potential of the given metal:



Arranging metals in the order on increasing of their standard electrode potentials we get the electrochemical galvanic series of metals.

Metals which stand after hydrogen in this row are unable to displace hydrogen from acids. The displacement of a metal from the salts by another metal can happen only if the displacing metal is situated before the displaced metal in the galvanic series of metals. The more is the gap between the metals in the electrochemical galvanic series (i. e. the greater is the difference in the standard potentials of metals), the greater is EMF of a galvanic cell in which these metals are used.

The galvanic series of metals has great significance for the choice of metals for therapeutic purposes and prosthetics in stomatology. You should avoid using metals with extremely different electrode potentials in the oral cavity. When these metals are used together, galvanic cells are formed and a more active metal will be destroyed. Saliva is the conductor of electrons. For example, a crown of tooth made of stainless steel and the one made of gold. In this case the crown of tooth made of stainless steel will be destroyed. The increase in saliva acidity ($\text{pH} < 7$) leads to the increase of potentials of metals and the following increase of EMF of the formed galvanic cells.

9.8. THE GLASS ELECTRODE

The glass electrode is an example of widely used ion-selective electrodes, because it is specific for H^+ ions (fig. 9.7). It consists of a very thin bulb or membrane made of a special type of glass that is permeable to H^+ ions. An Ag/AgCl electrode is immersed in 0.1 M HCl solution with constant pH equal to 1.

When the electrode is placed in a solution whose pH is different from 1, the potential difference between the two sides is a measure of the difference in the two pH values. The following equations relate membrane potential of the glass electrode to acidity of a test solution:

$$\varphi = \varphi^0 + 0.059 \lg[\text{H}^+] \quad \text{or} \quad \varphi = \varphi^0 - 0.059 \text{pH}.$$

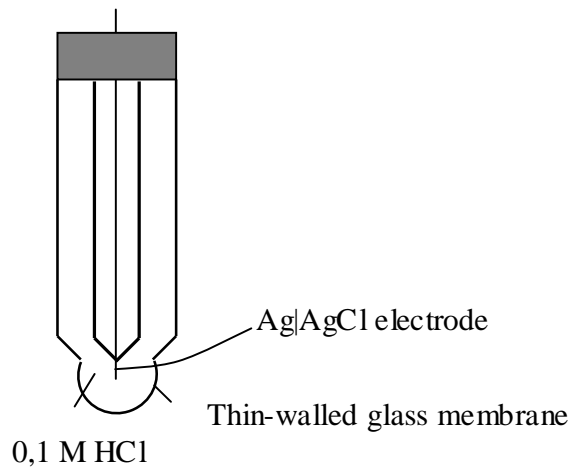
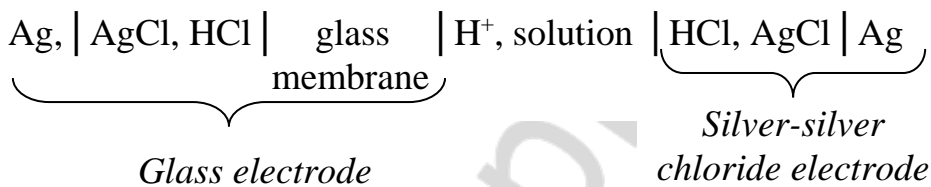

Fig. 9. 7. A glass electrode

Potentiometric pH. Determining pH from EMF measurements is a standard technique. The Galvanic cell, applied for this purpose, is a combination of the glass electrode (as an indicator electrode) and silver-silver chloride electrode (as a reference electrode).



Potentiometric pH determination is widely used in medical practice. A galvanic cell used for such an investigation is composed of a glass electrode (an indicator electrode) and a silver-silver chloride electrode (a reference electrode).

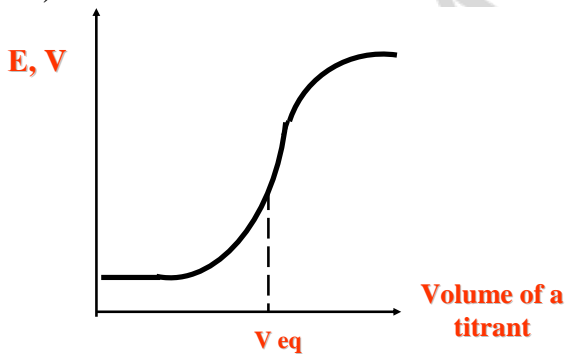

Fig. 9.8. Integral Curve of Potentiometric Titration

Potentiometric titration is a volumetric method in which the potential between two electrodes is measured (reference and indicator electrode) as a function of the added titrant volume. The voltage is recorded at intervals as the titrant is added. A potentiometric titration curve is a plot of potential as a function of the volume of added titrant (fig. 9.8). The end point of the reaction is half way between the jump in voltage.

Potentiometric titrations are preferred to manual titrations, since they are more accurate and precise. They are also more easily adapted to automation,

where automated titration systems can process larger volumes of samples with minimal analyst involvement.

Types of potentiometric titrations for the determination of analytes in test solutions include acid-base, redox, precipitation, and complexometric. Applications of potentiometric measurements are:

- Analysis of coloured and turbid solutions, pasts and gels.
- Analysis of biological fluids without their destruction.

The experimental data can be received quickly and accurately (express analysis).

9.9. OXIDATION-REDUCTION POTENTIALS

The electrode potential of any metal is the oxidation-reduction potential (OR-potential). But in electrochemistry OR-potentials are only those which occur on the inert electrodes (Pt, Pd and so on) in the result of redox reaction. The material of these electrodes in the course of redox reaction is unchanged and serves as a transmitter of electrons. These electrons are formed on the surface of the electrode in the result of this reaction as in case with a platinum plate immersed into the solution containing FeCl_2 and FeCl_3 .

The OR-electrode scheme will be written as follows:

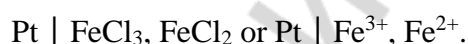

The presence of a comma between the oxidized and the reduced forms shows the absence of interface between them in the solution. The oxidizing agent Fe^{3+} and the reducing agent Fe^{2+} are constantly interacting with each other. This exchange process is described by the following equation:



In every semi-reaction the substance with a higher oxidation number is called the oxidized form (Ox) and the substance with a lower oxidation number is called the reduced form (Red). The oxidized and reduced forms make up a conjugate OR-couple $\text{Fe}^{3+} \mid \text{Fe}^{2+}$.

In the presence of platinum the electron exchange between ions speeds up. At the same time the electric charge appears on the metal and it's formed at the boundary of EMF. Gradually there is the balancing between oxidation and reduction rates and there comes the EMF equilibrium characterized by a certain value of OR-potential in the system inert metal (Pt) — solution ($\text{Fe}^{3+}/\text{Fe}^{2+}$).

The system potential, measured with respect to hydrogen electrode potential taken as 0 provided the activities (concentrations) of oxidized and reduced forms equal 1 mol/L, is called standard OR-potential.

The values of standard OR-potentials of some systems are shown in the table 9.3.

Standard oxidation-reduction (electrode) potentials at 298K

System	Half-element reaction	φ^0 (V)
$F_2/2F^-$	$F_2 + 2\bar{e} \rightarrow 2F^-$	+ 2,87
MnO_4^-/Mn^{2+}	$MnO_4^- + 8H^+ + 5\bar{e} \rightarrow Mn^{2+} + 4H_2O$	+ 1,51
$Cr_2O_7^{2-}/2Cr^{3+}$	$Cr_2O_7^{2-} + 14H^+ + 6e^- \rightarrow 2Cr^{3+} + 7H_2O$	+ 1,37
$Br_2/2Br^-$	$Br_2 + 2\bar{e} \rightarrow 2Br^-$	+ 1,07
Fe^{3+}/Fe^{2+}	$Fe^{3+} + \bar{e} \rightarrow Fe^{2+}$	+ 0,77
$I_2/2I^-$	$I_2 + 2\bar{e} \rightarrow 2I^-$	+ 0,54

Standard OR-potentials are a quantitative measure of oxidation-reduction ability of a system. The greater is the value φ^0 , the greater is the oxidizing ability of the oxidized form of the given pair. The reduction properties are more vivid in the reduced form in the pair with a lower value of φ^0 .

The value of OR-potential in normal conditions can be calculated using Nernst-Peters' equation :

$$\varphi_{(ox/red.)} = \varphi^0_{(ox/red.)} + \frac{RT}{nF} \ln \frac{a_{(ox)}}{a_{(red)}},$$

where n – number of electrons, participating in OR-reaction, $a_{(ox)}$ и $a_{(red)}$ are activities of oxidized and reduced forms in the solution. For example, for the electron mentioned above the equation will be the following:

$$\varphi_{Fe^{3+}/Fe^{2+}} = \varphi^0_{Fe^{3+}/Fe^{2+}} + \frac{RT}{nF} \ln \frac{a_{Fe^{3+}}}{a_{Fe^{2+}}} \text{ where } n = 1$$

If the conjugate OR-system includes ions H^+ or OH^- , the potential of such system will also depend on their activity.

For example, for the system $MnO_4^- + 8H^+ + 5\bar{e} \rightleftharpoons Mn^{2+} + 4H_2O$ Nernst-Peters' equation will be like that:

$$\varphi_{MnO_4^-/Mn^{2+}} = \varphi^0_{MnO_4^-/Mn^{2+}} + \frac{RT}{nF} \ln \frac{a_{MnO_4^-} \cdot a_{H^+}^8}{a_{Mn^{2+}}} \text{ where } n = 5.$$

So, the value of OR-potential is influenced by the nature of conjugate OR-couple, the activity ratio of oxidized and reduced forms in the solution, temperature and pH of the solution. As appears from Peters' equation the higher is the temperature and the concentration of the oxidized form and the less is the concentration of the reduced form in the solution, the greater is the value of OR-potential and the oxidizing ability of the system.

9.10. SPONTANEITY OF REDOX REACTIONS

As we know from thermodynamics a reaction occurs spontaneously if the change in Gibbs free energy is $\Delta G < 0$, i. e. the free energy of the system is decreased in the result of this reaction. ΔG^0 of the reaction can be calculated using the equation:

$$\Delta G^0_{\text{reaction}} = \sum \Delta G^0_{\text{products}} - \sum \Delta G^0_{\text{reactants}}.$$

For redox reactions these calculations can be done in another way. In case of reversible reactions the yield equals the change in free energy with a negative sign:

$$A_{\text{yield}} = -\Delta G.$$

For redox reactions (OR-reactions) the yield is the action used to strip off the electrons from the substance while transferring it from reduced to oxidized form, i.e.

$$A_{\text{electric}} = -\Delta G.$$

The action of charge transfer (q) can be calculated as follows:

$$A_{\text{electric}} = q\Delta E,$$

where ΔE is the potential drop of electrodes. The quantity of the transferred electric charge is calculated as follows: $q = nF$,

where n — number of electrons transferred in the basic act of the reaction, F — Faraday's number equal 96500 c/mol.

We get the following:

$$A_{\text{electric}} = -nF\Delta E, \text{ but, } A_{\text{electric}} = -\Delta G, \text{ hence } \Delta G = -nF\Delta E.$$

Formula $\Delta G = -nF\Delta E$ shows that for the spontaneous proceeding of the process the potential drop should be a positive value ($\Delta E > 0$), because only in this case $\Delta G < 0$. So, we can use ΔG or ΔE to estimate the spontaneous course of OR-reaction.

Any OR-reaction occurs only in this direction when weaker reducing and oxidizing agents are formed from stronger ones.

OR-system with greater OR-potential always plays the role of the oxidizing agent in reference to OR-system with lower OR-potential. For example,

$$\text{Co}^{3+} \mid \text{Co}^{2+} \varphi^0(\text{ox, red}) = +1,84\text{V}$$

$$\text{Fe}^{3+} \mid \text{Fe}^{2+} \varphi^0(\text{ox, red}) = +0,77\text{V}$$

In each pair there is its own reducing and oxidizing agent. The values mentioned above we can see that Co^{3+} is a stronger oxidizing agent than Fe^{3+} .

Let's calculate the driving force of OR-reaction:

$$\text{Co}^{3+} + \text{Fe}^{2+} \rightarrow \text{Fe}^{3+} + \text{Co}^{2+} \Delta E = \varphi_{\text{ox}}^0 - \varphi_{\text{red}}^0 = +1,84 - 0,77 = 1,07\text{V}$$

In our case $\Delta E > 0$ and the reaction occurs spontaneously from left to right.

If there are several reducing agents in the solution and we add an oxidizing agent, the oxidizer interacts with the strongest reducer first of all. This fact can explain why the transfer of protons and electrons in a chain of biological oxidation in tissues occurs on the following scheme:

$$\text{OXIDIZED SUBSTRATUM} \quad \varphi = -0,42\text{V}$$

↓	
DEHYDROGENASE	$\varphi = -0,32V$
↓	
FLAVIN ENZYME	$\varphi = -0,06V$
↓	
CYTOCHROMES	φ from +0,04 to +0,55V
↓	
$\frac{1}{2}O_2$	$\varphi = +0,82V$

Strict sequence of enzymes in the oxidation chain excludes the drastic difference between potentials of two interacting systems and this explains gradual emission of oxidation energy. The ability of biological oxidation helps the organism regulate gaining and using of energy more correctly.

CHAPTER 10

Physico-Chemistry of Surface Phenomena

In any living organism there is a huge number of heterogeneous systems at the surface of which a lot of biochemical processes take place. All the processes occurring at the border of phase division are called surface phenomena. All surface phenomena can be characterized by low activation energy. This is the reason why biochemical reactions occur at the borders of the division at a high speed at the temperature of the environment.

10.1. SURFACE ENERGY AND SURFACE TENSION

All interfaces are divided according to their aggregate state into two classes:

1. *Mobile interfaces*: liquid – gas (l–g) and liquid – liquid (l–l);
2. *Immobile interfaces*: solid – gas (s–g), solid – liquid (s–l), solid – solid (s–s)

The total energy of the system consists of two summands: Gibbs' energy of volume phase G_v and Gibbs' surface energy G_s : $G = G_v + G_s$

Gibbs' energy of volume phase is proportionate to its volume occupied by the system: $G_v = kV$

Gibbs' surface energy of the system is proportionate to interfacial area: $G_s = \sigma \cdot S$,

where σ is the constant of proportionality called surface tension, $Joul/m^2$; S – interface area, m^2 .

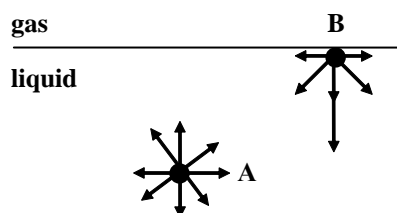

Fig.10.1. Intermolecular forces affecting the molecules in the surface layer and in the volume of the liquid. Explanations are in the text.

Let's consider the mechanism of initiation of Gibbs' surface energy by the example of bi-phase water system: water – water vapor (l-g). Intermolecular forces affecting a water molecule (A) are evenly exhibited by neighboring molecules. The re-

sultant of these forces is equal to 0. The molecule B situated at the interface is influenced by the total attraction forces of a unit of volume of a liquid to a greater extent than by a unit of volume of a gas because of its tenuity.

That's why the resultant of molecular forces for the surface molecules is not equal to 0 but it is directed inside the liquid and as a result of it the surface molecules tend to be drawn into the liquid phase.

So, the molecules in the surface layer have uncompensated attraction forces and that's why possess excess surface energy. From the thermodynamic point of view such a condition is not beneficial energetically. The molecules in the surface layer tend to be drawn into the liquid phase and that causes the decrease in interfacial area of phases. This can be explained by the spherical form of small drops and by ideally smooth surface of a liquid in a wide vessel. The process of molecular transfer from the depth of a liquid to its surface requires a loss of energy to overcome the intermolecular interaction forces. The activity directed at the surface increase transfers into the potential energy of molecules in the surface layer which is the surface energy.

The surface energy accounted for a unit of surface area (specific surface energy) is called **surface tension (σ)**: $\sigma = G_s / S$.

The units of measurement of surface tension in SI system are: Joule/m² or Newton/m as Joule=Newton ·m.

Surface tension of different liquids is different and depends on the nature of a liquid, the nature of an adjoining phase, temperature, pressure (if an boundary phase is a gas), the nature and concentration of solutes.

With the increase in temperature surface tension decreases and at the temperature of boiling the boundary between the phases disappears and the system gas-liquid becomes homogeneous. That's why the unit of surface tension is the measure of both heterogeneous systems either gas-liquid or liquid-liquid.

With the increase in pressure surface tension at the border liquid-gas decreases as the molecular concentration in the gaseous phase increases and the energy excess of molecules on the surface decreases.

Dissolved substances depending on their nature can influence the surface tension of liquids in different ways. The ability of dissolved substances to change the surface tension of a solvent is called surface activity. According to

the ability to change the surface tension all the substances are divided into three groups:

1. *Surface-active substances* (SAS) which reduce the surface tension of a solvent. With respect to water SAS are a number of organic substances: alcohols, acids of aliphatic series and their salts (soaps), esters, amines, proteins and so on.

2. *Surface-inactive substances* (SIS) which increase insignificantly the surface tension of a solvent. With respect to water SIS are a number of inorganic acids, bases, salts and some organic substances like glycine (aminoacetic acid).

3. *Surface-non-active substances* (SNS) which don't change the surface tension at all. With respect to water SNS is saccharose and some other substances.

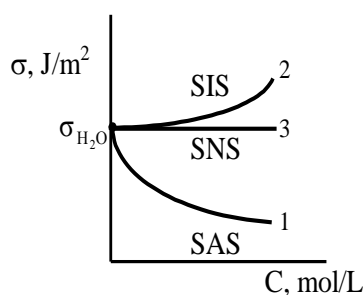

Fig. 10.2. Surface tension isotherm: aqueous solutions of:

1. Surface-active substances (SAS);
2. Surface-inactive substances (SIS);
3. Surface-non-active substances (SNS).

Fig. 10.2 shows the dependence of surface tension change of aqueous solutions of indicated groups of substances on their concentration (isothermal curve of surface tension, $T = \text{const}$). As we can see at fig. 10.2 with the increase in SAS concentration the solution surface tension reaches its minimum limiting value; with the increase in SIS concentration the solution surface tension increases and with the increase in SNS concentration the solution surface tension is stable.

Ducklo-Traube rule. *Surface activity of substances in the same homologous series increases \approx three times with the increase in hydrocarbon chain in $-CH_2-$ group (for diluted aqueous solutions). At the same time the surface tension of their solutions decreases.*

This rule can be well-illustrated by the set of curves shown at fig.10.3.

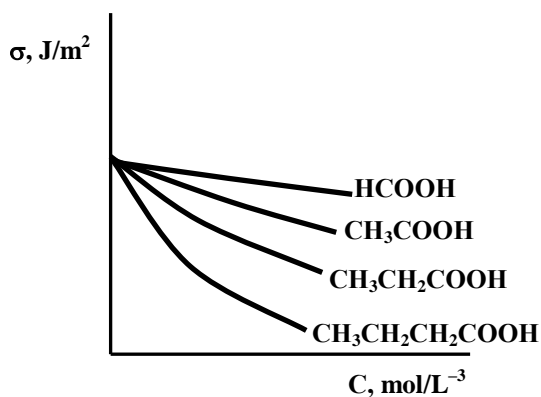

Fig.10.3. Set of isotherms of surface tension for aqueous solutions of homologous series of fatty acids.

one represented by the following functional groups $-\text{COOH}$; $-\text{OH}$, $-\text{NH}_2$ and others. Such substances are called *diphilic*. Diphilic SAS molecules are denoted by symbol where a circle is a polar group and a dash is a non-polar radical.

The importance of surface phenomena in medicine. Water is the most frequently used solvent. It has great surface tension ($72,75 \text{ Joule/m}^2$ at 20°C) that's why with respect to it many substances are surface-active ones. The surface tension of biological fluids (e.g. blood serum) is less than that of water because of the presence of different SAS (acids of fatty series, steroids and so on) in biological fluids. These substances are accumulated (absorbed) spontaneously at vessel walls, cell membranes, which makes it easier for them to penetrate through these membranes.

These changes in surface tension of biological liquids are used for diagnosis. For example, the surface tension of blood plasma can be drastically changed in the course of different diseases (anaphylactic shock, cancer and others). With age, the surface tension of blood serum decreases.

Judging from numerous methods of measuring the surface tension there are two main methods: the stalagmometric method and the method of squeezing of air bubbles which are used in biochemical, physiological and clinical investigations.

10.2. ADSORPTION AT THE MOBILE INTERFACE OF PHASES

Gibbs' equation. The spontaneous change of solute concentration at the interface of phases is called adsorption. It can be measured quantitatively in mol/m^2 or mol/cm^2 . The quantity of the adsorbed substance at the interface liquid-gas and liquid-liquid is much less than in the volume. That's why it's difficult to measure it and its value is calculated with the help of Gibb's equation:

$$\Gamma = - \frac{\Delta\sigma}{\Delta C} \cdot \frac{C}{RT}, \quad (10.1)$$

In some cases the biological activity (e.g. narcotic action, bactericidal action and so on) of the substances of the same homologous series increases with the increase of their surface activity.

Ducklo-Traube rule is observed only for aqueous solutions of SAS. The ability of SAS to decrease water surface tension can be explained by the fact that SAS molecules consist of non-polar hydrocarbon part and the polar

where Γ is the amount of substance, adsorbed by a unit of interface of phases, mol/m²; C is the equilibrium molar concentration of a solute, mol/L, R is the gas constant equal to 8, 341 Joul/mol · K; $-\frac{d\sigma}{dC}$ is the first derivative of surface tension with respect to concentration taken with the minus.

At small concentration intervals the derivative in Gibbs' equation can be substituted by the ratio of final changes:

$$\Gamma = - \frac{\Delta\sigma}{\Delta C} \cdot \frac{C}{RT}, \quad (10.2)$$

where $\Delta\sigma = \sigma_2 - \sigma_1$ changes in the surface tension occurring in the solution concentration change:

$$\Delta C = C_2 - C_1.$$

Gibbs' equation shows the following dependence: the more the surface tension decreases with the increase in the adsorbed substance concentration, the greater is its surface activity. This indicates that the minus shows the inverse interdependence between the value of adsorption Γ and the surface tension σ .

If $\Delta\sigma / \Delta C < 0$ then $\Gamma > 0$, i. e. the adsorption is positive (substance is accumulated at the interface), it's characteristic of SAS.

If $\Delta\sigma / \Delta C > 0$ then $\Gamma < 0$, i. e. the adsorption is negative (substance is accumulated in the volume), it's characteristic of SIS.

The adsorption of a substance is a reversible process which finishes up with the establishment of adsorption equilibrium when the rate of adsorption is equal to the rate of the reverse process, i. e. desorption.

10.3. ORIENTATION OF SAS MOLECULES IN THE SURFACE LAYER. STRUCTURE OF BIOLOGICAL MEMBRANES

The existence of surface tension minimal value of SAS solutions and the adsorption limiting value (Γ_∞) allowed I. Langmure to make a suggestion about the orientation of absorbed SAS molecules in the surface layer.

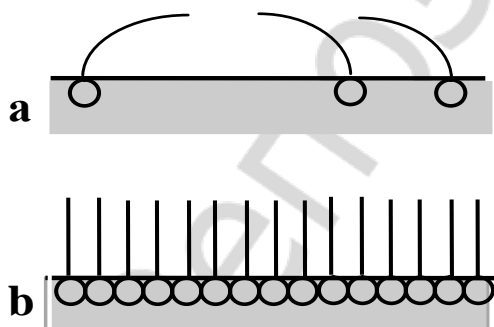

SAS molecules consist of two parts: polar (hydrophilic) and non-polar (hydrophobic). At adsorption the polar group having a great similarity to polar phase (e. g. water) is drawn into it. At the same time the non-polar group is pushed out into the non-polar phase (fig. 10.4).

At small concentrations of SAS hydrocarbon radicals «lie» on the surface of the polar liquid and the polar groups are immersed into it (fig. 10.4a).

Fig. 10.4. Monomolecular layer structure by Langmure

With the increase in SAS concentration in the solution the number of molecules situated in the surface layer increases. This leads to the formation of a monomolecular adsorption layer (fig.10.4b) on the interface surface where SAS molecules are extremely orientated. The existence of this monomolecular adsorption layer can explain the permanent character of adsorption maximum (Γ_{∞}) of organic substances situated in the same homologous series.

The ideas about the SAS molecule orientation in saturated adsorption layer played a great role in the development of studies about biological membranes (fig. 10.5).

Cell membranes are generally formed by the molecules of two types: lipids and proteins.

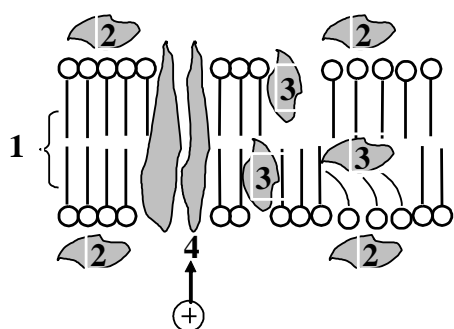

Fig. 10.5. Mosaic structure model of a biological membrane:

- 1 — lipid bilayer;
- 2 — surface proteins;
- 3 — integral proteins;
- 4 — ionic channel

Lipids are insoluble in water but soluble in organic solvents. The distinctive feature of membrane lipids is that one end of their molecules is a polar group (e.g. $-\text{COOH}$) possessing hydrophilic properties while the other end is a long hydrocarbon chain with hydrophobic properties. Lipids form bimolecular films (nearly 70 \AA thick) where the polar groups are arranged on both membrane surfaces and non-polar ones are immersed into it.

Protein molecules can be arranged close to the inner and outer sides of the membrane surface and can also partially or completely penetrate through all its thickness.

Usually cell membranes are rather durable and have the properties of an electric insulator. Biological membranes are not rigid structures. For example, in many cases lipids and proteins are in constant motion inside the membrane.

10.4. ADSORPTION AT THE IMMOBILE INTERFACE OF PHASES (AT THE SURFACE OF A SOLID)

Adsorption at the immobile interface of phases is the accumulation of one substance on the surface of the other one. A solid at the surface of which another substance is accumulated is called the *adsorbent* and the adsorbed substance is called the *adsorptive*. Separate atoms or groups of atoms standing out on the adsorbent surface are called *active centers*. They have a great amount of Gibbs' surface energy and the adsorption takes place on them first of all.

We should differentiate between chemical and physical adsorption. At physical adsorption adsorbent and adsorptive interact due to Van der Waals

forces. This adsorption occurs spontaneously, it's reversible and not very specific. With the increase in temperature the physical adsorption decreases.

At chemical adsorption (chemisorption) there is a chemical bond between adsorbent and adsorptive and each of the two loses its individuality. This adsorption is similar to a chemical reaction and is usually accompanied by the formation of compounds at the interface of phases. For example, the adsorption of CO₂ on the slaked lime leads to the formation of a thin layer of calcium carbonate on its surface:

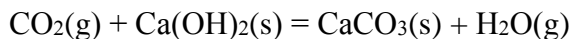

The interaction energy at chemical adsorption is 40 – 400 kJ/mol, the value for physical adsorption (10 – 40 kJ/mol).

Chemosorption is characterized by specific interaction and is often irreversible. At chemical adsorption instead of the adsorbed substance another substance can be desorbed.

Adsorption depends on the nature of adsorbent and adsorptive, temperature, specific surface area of adsorbent, pressure of adsorptive (for gas adsorption), the nature of solvent and the concentration of adsorptive in the solution (for adsorption from the solutions).

Non-polar adsorbents like graphitic carbon or activated coal *adsorb non-polar organic substances better. Polar adsorbents are better adsorbed at the surface of polar adsorbents* like, for example, silica gel, aluminium oxide, cellulose and others.

At the same mass of the adsorbent adsorption increases with the increase of specific surface area (i.e. grinding) of adsorbent.

To describe the experimentally obtained data on absorption on the surface both of a solid and a liquid we can use a great number of equations but the most frequently used are the equations of Langmure and Freindlikh.

Langmure's equation. The monomolecular adsorption theory was suggested in 1915 by an American physicist and chemist I. Langmure and it contains the following ideas:

- 1) Particles of a substance are situated only on the active centers of the adsorbent.
- 2) Each particle of the adsorptive occupies one active center of the adsorbent.
- 3) Adsorption finishes with the formation of a monomolecular layer.
- 4) In a certain period of time the adsorbed molecules leave the active centers and are replaced by other molecules, i.e. there comes the dynamic equilibrium: adsorption \rightleftharpoons desorption.
- 5) It is assumed that there is no interaction between the adsorbed molecules.

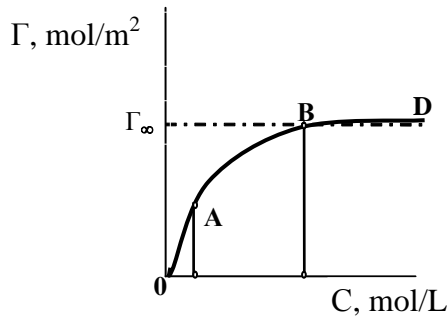

Fig.10.6. Langmuire's adsorption isotherm.
Explanations are in the text

Based on these postulates *Langmuire suggested the equation of adsorption isotherm*: $\Gamma = \Gamma_{\infty} \frac{C}{K + C}$, (10.3)

where Γ_{∞} is a constant equal to the maximum adsorption, observed at relatively big equilibrium concentrations, mol/m²; K is the constant equal to the ratio of the constant of desorption rate to the constant of adsorption rate; C is the equilibrium solution concentration, mol/L.

Langmuire's equation can have different forms depending on the equilibrium adsorptive concentration.

At very small concentrations ($C \ll K$) the value C in the equation can be neglected and the equation has a linear form: $\Gamma = \Gamma_{\infty} \frac{C}{K}$, i.e. the dependence between the adsorption and the concentration is illustrated by a line which goes through the initial point of data lines (fig. 10.6, section OA).

If the concentration is high ($C \gg K$), the value K in the denominator can be neglected and then $\Gamma = \Gamma_{\infty}$ i.e. the amount of adsorbed substance reaches its maximum and doesn't depend on the concentration (section BD).

When $K=C$, then $\Gamma = \frac{1}{2} \Gamma_{\infty}$. As it appears from this, constant K in Langmuire's equation is quantitatively equal to such equilibrium concentration when one half of active centers at the adsorbent surface is occupied by adsorptive molecules and the other half is free.

At medium concentrations Langmuire's equation doesn't illustrate adsorption quantitatively (the parabolic section AB of adsorption isotherm).

Friendlikh's equation. G. Friendlikh assumed that the higher is the gas pressure (p) and the concentration (C) of a solute, the greater amount of gas or a substance will be adsorbed on the surface. This dependence is not in direct proportion but it has a parabolic character which is shown in *Friendlikh's equation*:

$$\Gamma = Kp^{1/n} \text{ or } \Gamma = KC^{1/n}, \quad (10.4)$$

where p is the equilibrium gas pressure in the system; C is the equilibrium concentration; K and $1/n$ are the constants.

Friendlikh's equation is the equation of a parabola (fig.10.7) and can't explain the almost linear increase of adsorption at low concentrations and the maximum adsorption value independent on the concentration. Constant $1/n$ characterizes the curvature of adsorption isotherm, i.e. the deviation of isotherm from the line; K is the adsorption value at the equilibrium adsorptive concentration equal to 1 mol/L (at $C=1$ mol/L and $\Gamma=K$). The constant K usually varies within wide limits. Constant $1/n$ is a proper fraction. With the increase in temperature the K value should be decreased and $1/n$ vice versa

should increase. It's obvious that this almost linear section of the isotherm for small pressure and concentration can be obtained with the help of Freundlich's equation only in this case when $1/n=1$. In the same way the horizontal linear section of isotherm with corresponding high pressure and concentration can be obtained only if $1/n=0$.

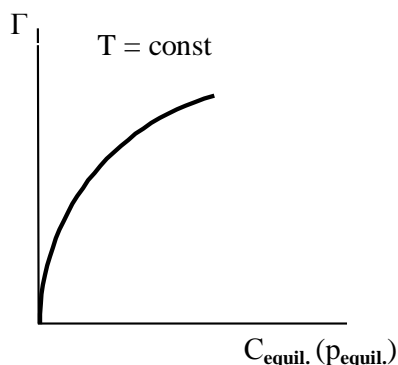

Fig.10.7. Freundlich's adsorption isotherm

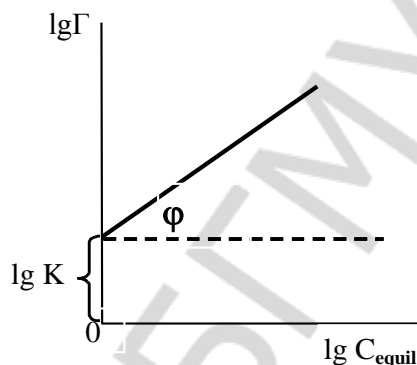

Fig.10.8. Graphic estimation of constants in Freundlich's equation

So, constant $1/n$ is in reality function of C or p . As we take $1/n$ as a constant varying in the range of 0,2–1 (for adsorption from gaseous medium) or 0,1–0,5 (for adsorption from solutions).

Freundlich's equation can be used only for the interval of medium pressure and concentration.

Constants of Freundlich's equation can be easily found in the diagram form on the isotherm drawn in logarithmic coordinates (fig.10.8) so, for the adsorption from a solution we have:

$$\lg \Gamma = \lg K + 1/n \lg C \quad (10.5).$$

The dependence of $\lg \Gamma$ on $\lg C$ is expressed by a straight line. The segment cut off by the line on the y-coordinate is equal to $\lg K$, and the tangent of angle (φ) of slope of the line to the x-coordinate is equal to $1/n$. It should be mentioned that at taking the logarithm of the equation Γ must be expressed in mol/gram and C_{equil} in mol/L.

The ideas suggested by Langmuire and Freundlich idealize and simplify to a great extent the real picture of adsorption. In reality, the surface of many adsorbents is not homogeneous, adsorbed particles interact with each other and adsorption isn't often finished with the formation of the monomolecular layer. In this case the equation of adsorption isotherm is more complicated.

Medical-biological importance of adsorption. Adsorption of substances and different gases plays a great role in the living processes. For example, due to great specific surface area of erythrocytes they are as quickly saturated with oxygen in lungs as liberated from excess of carbon dioxide. This is the reason of quick poisoning of organism by toxic fumes and gases. Medical substances are

easily adsorbed on the erythrocytes surface and are transported by blood to organs and tissues.

Adsorption processes are used for the excretion of toxic substances from the organism. With this purpose blood, plasma and lymph are run through a layer of adsorbent. These processes are called hemosorption, plasmasorbition, lymphosorbition.

A lot of research is carried up to improve the properties of sorbents aimed at the excretion of radioactive nuclides (mostly strontium and cesium) and toxic metals from the organism. In this case the adsorption processes are accompanied by the formation of complex compounds and the reaction of ion exchange.

CHAPTER 11

Chromatography and Its Types

The main ideas of chromatography were formulated in 1903 by a Russian botanist M. Tsvet. When an extraction of green leaves is passed through a glass tube filled with chalk powder and it is followed by rinsing of the tube by ligarine, Tsvet was able to obtain several coloured zones. This method of separation of complex mixtures was called chromatography (from the Greek *chrōma*, meaning «colour» and *graphein*, meaning «to write») by Tsvet.

Chromatography is a physical-chemical method of separation and analysis of mixtures, vapours, liquids or solutes by adsorption methods in dynamic conditions. It is based on different distribution of mixture components between two phases: mobile and immobile.

The immobile (stationary) phase can be liquid or solid. It can be a finely ground sorbent or water fixed by a sorbent or paper fibre.

The mobile phase is a flow of liquid or a gas which is transferred together with the components of the mixture through the immobile phase (sorbent).

When the mixture of substances passes through the adsorbent layer, constant acts of adsorption-desorption take place. Any substance in a mobile phase interacts with new sections of a sorbent (is sorbated) but the sorbate is again desorbed under the influence of the mobile phase.

Numerous chromatographic methods can be classified according to the following principles: *the state of aggregation of mobile and immobile phases, the mechanism of interaction sorbent-sorbate, technique of carrying out chromatography and its aims.*

According to the purpose of chromatography it can be divided into *analytical* (qualitative and quantitative analyses), *preparatory* (for obtaining substances in pure state, for concentration and isolation of trace contaminants) and *industrial chromatography*.

According to the aggregative state of mobile phase chromatographic methods are divided into *gaseous and liquid* ones.

Gas chromatography is generally used for separation, analysis and investigation of substances and their mixtures which turn into vapourized [vaporous] state without decomposition. According to the aggregative state of immobile phase it can be gas-solid phase and gas-liquid phase chromatography.

In gas chromatography such inert gases as helium, argon, nitrogen and less often hydrogen and carbon dioxide are used as the mobile phase (gas-carrier).

Gas chromatography process is usually carried out in special devices called gas chromatographs. The general scheme of a chromatograph is shown at fig. 11.1.

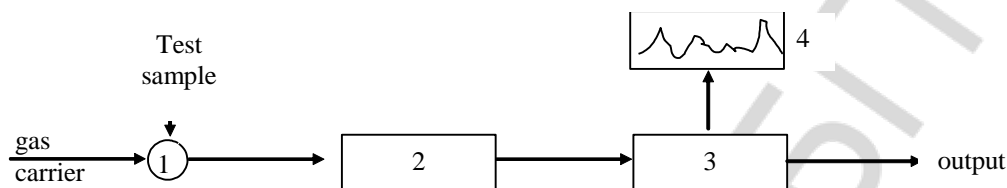

Fig.11.1. Schematic diagram of a gas chromatograph.

1 — It is the device for the input of a test sample into a chromatographic column (dispensing apparatus); 2 — is a chromatographic column; 3 — is a detector (analyzing system); 4 — is the recorder.

The flow of carrier gas is constantly sent to the chromatographic column and after that to the detector. This device constantly measures the component concentration at the output and transforms it into an electrical signal registered by the potentiometer. At the recorder chart we can see the output curve called a chromatogram.

According to the technique of carrying out we can single out *column and planar chromatography*.

In planar chromatography the separation is carried out on some special paper (paper chromatography) or in a thin layer of a sorbent (thin layer chromatography).

11.1. THIN LAYER CHROMATOGRAPHY

At this type of chromatography (TLC) the immobile solid phase is applied at a plate made of glass, aluminium foil or a polymer film. As a sorbent it's possible to use silica gel, aluminium oxide, starch, cellulose and other substances with high adsorption ability.

Usually a mixture of substances in the form of a stain or a strip is applied at the starting line which is 2–3 cm from the plate edge (fig. 11.2). The plate edge is immersed into a solvent (or a system of solvents) which acts as a mobile phase. Under the influence of capillary forces the solvent moves up along the sorbent layer transferring the components of this mixture at different rate, which explains their separation. Standard substance («witness») in the same solvent where there is the analyzed sample is also applied at the

starting line. At the same time the influence of different factors on all the substances will be equal.

At the end of the experiment the obtained chromatogram is dried and developed by a chemical (the plate is sprayed by a solution of a reagent interacting with the components of this mixture) or a physical (e.g. the autoradiographic method or other methods) method.

For the obtained stains (zones) of substances on the chromatogram (fig. 11.2) we can calculate *the retention index R* using the formula:

$$R = \frac{L_{\text{subs}}}{L_{\text{solv}}}, \quad (11.1)$$

where L of a substance and L of a solvent are the travelled paths of a substance and a solvent, when the time of experiment is the same.

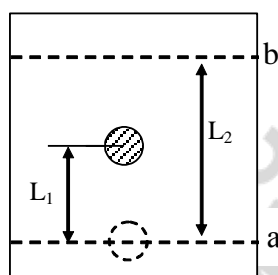

Fig. 11.2. The determination of retention index R .

Designations: a and b are the starting and the finishing lines respectively, L_1 and L_2 are the traversed paths of a substance and a solvent respectively.

If the retention index of one of the components in the mixture coincides with the retention index of a known substance («witness»), it means that their chemical compositions are equal.

According to the mechanism of interaction of a sorbent and a sorbate we can single out several other types of chromatography: *adsorption, distributive, ion exchange, exclusion and affine chromatography*.

This classification may vary because the interaction mechanism of the sorbent and the sorbate has no definite limits. *Regardless of the distribution mechanism all chromatographic methods are based on the differences in the degree of distribution of mixture components between the mobile and immobile phases.*

The distribution degree of substances can be quantitatively described by a constant or **the coefficient of distribution K** :

$$K = \frac{C_s}{C_m}, \quad (11.2)$$

where C_s , C_m are the concentrations of a substance in immobile (stationary) and mobile phases respectively.

To separate substances in the column in practice we can often use elution chromatography method. The mixture of substance A and substance B is loaded into the upper part of the column (fig. 11.3). While a pure solvent is passed through the column, the substances are washed away from it. This process is called elution, which gave its name to elution chromatography.

The loaded components A and B of the mixture are distributed between two phases according to their distribution coefficients:

$$K(A) = \frac{C_s(A)}{C_m(A)} \quad \text{and} \quad K(B) = \frac{C_s(B)}{C_m(B)}$$

At the constant passing through of the solution (eluent) molecules of A and B substances are continuously rearranged between the mobile and immobile phases. The average mixing rate of the substance depends on its duration of stay in the mobile phase and its ability to be adsorbed in the immobile phase. If the moving rates of A and B components are quite different, then at the output the first is the least sorbated component A and only then appears component B. At the output the column can be joined to the chromatographic detector reacting at the concentration change of the given substances.

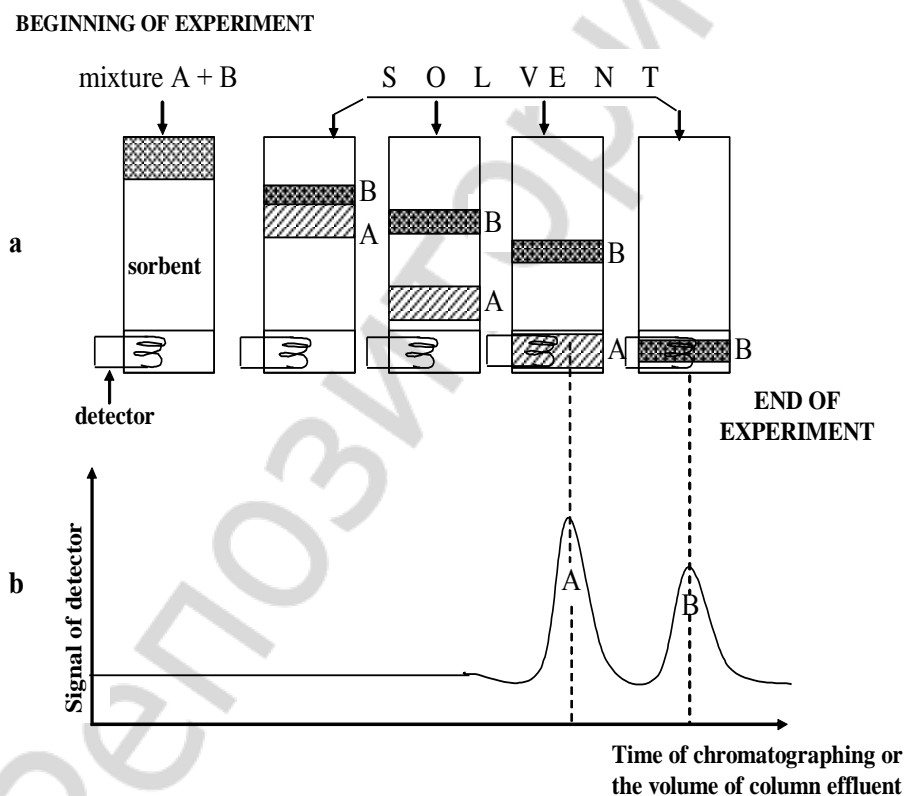

Fig.11.3. Scheme of elution chromatography of a two-component mixture.

On x-coordinate we can indicate the time of chromatographic process (volume of eluent) and on y-coordinate we can indicate the analytical signal

which depends on the concentration of A and B substances in the eluent (fig. 11.3b). Each peak corresponds to the definite substance. The height or the area of a peak helps to identify its concentration. That's why chromatograms are used for both quantitative and qualitative analyses.

11.2. ELEMENTS OF THE KINETIC THEORY OF ELUTION CHROMATOGRAPHY

At chromatography there is the peak smearing of separated substances. The kinetic theory explains the peak smearing and predicts good separation of substances. In theory more attention is paid to the connection between the kinetics process and the diffusion with slow establishment of the equilibrium and nonuniformity of the process. Let's take L as the column length where t_m is the time of solvent transfer through the column; t is time of substance transfer when the movement rate of the solvent (V_m) and of the substance (V) are the following:

$$V_m = \frac{L}{t_m} \quad \text{and} \quad V = \frac{L}{t} \quad (11.3)$$

*The ratio of the movement rate of the substance to the movement rate of the solvent is called the retention index **R**.*

$$\frac{v}{v_m} = \frac{L/t}{L/t_m} = \frac{t_m}{t} = R \quad (11.4)$$

It is also called the retention coefficient or the deceleration coefficient.

*The higher is the movement rate of the substance, the greater is the value **R** of it in the mobile phase.* The retention index characterizes the time fraction of the presence of the substance or a part of the substance in the mobile phase. Then $(1 - R)$ is the time fraction spent by the substance or a part of the substance in the immobile phase.

At the dynamic equilibrium the ratio of time intervals spent by the substance in each of the phases will be equal to the ratio of quantities of substance in both phases:

$$\frac{R}{1-R} = \frac{C_m V_m}{C_s V_s} \quad (11.5)$$

where C_s, C_m are the molar concentrations of the substance in the immobile and mobile phases respectively; V_s, V_m are the volumes of immobile and mobile phases respectively.

Any process of substance distribution between these two phases is characterized by the distribution coefficient K . Substituting the value $C_s = K C_m$ from formula (11.2) into the formula (11.5) and carrying out some mathematical transformations we obtain the following for the retention index:

$$R = \frac{V_m}{KV_s + V_m} \quad (11.6)$$

The equation (11.6) connects the part of the substance in the mobile phase with the distribution coefficient of the substance and the volumes of both phases. *The less is the distribution coefficient K , the higher is the rate of the substance moving along the column as its retention index R in the mobile phase is greater.*

As we can see at fig. 11.3a substance B is retained in the column stronger than substance A, therefore $K(B) > K(A)$, and $R(B) < R(A)$. As it appears from this, substance A is more related to the mobile phase (solvent) and substance B is more related to the immobile, stationary phase (sorbent). This example can be considered a typical example of molecular-adsorption or simple adsorption chromatography.

11.3. ADSORPTION CHROMATOGRAPHY

It is based on different adsorption of substances by a solid adsorbent. In adsorption chromatography *polar* ($Al_2O_3 \times H_2O$, $SiO_2 \times H_2O$, starch, cellulose) and *non-polar* (activated carbon, graphitized [carbon] black) *sorbents* are used. As a solvent it's possible to use water, alcohols, benzene, hexane, ester and ethers. Adsorption of different substances from the solutions depends on the nature of the sorbent, separated substances and the solvent.

In medicine hemosorption is used when to purify the blood from toxic substances it's possible to use activated carbon (non-polar sorbent). Activated carbon is also used for purifying food alcohols, syrup and others. Polar adsorbents (clay) are used for refining of fats (i.e. for the purification from free fatty acids).

11.4. ION EXCHANGE CHROMATOGRAPHY

*The base of ion exchange chromatography is the ion exchange adsorption carried out with the help of adsorbents which are called **ionites**.* Ionites are solid substances containing functional groups the ions of which are able to exchange ions for ions in the solution and they are almost insoluble in water and organic solvents.

Ionite structure has a form of a skeleton «sewed» by ordinary covalent bonds (fig. 11.4). The skeleton (matrix) has a positive or a negative charge compensated by the opposite charge of mobile ions i.e. counterions.

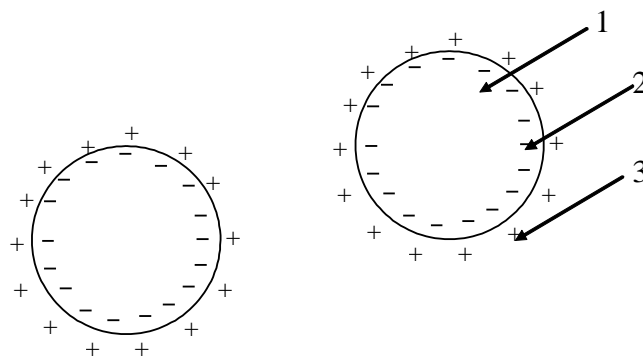

Fig. 11.4. Schematic sketch of ionite structure (cationite):

- 1 — matrix – space skeleton;
- 2 — charge of functional ionized groups;
- 3 — counterions connected electrostatically with the ionized groups.

Counterions can be substituted by other ions with the same charge. The skeleton plays the role of a polyion and can explain the ionite insolubility in solvents.

Ion exchange adsorption depends greatly on the nature of adsorbent (ionite), the functional groups in its composition, their ability to polarize and the ion-adsorbate nature.

Classification and properties of ionites. According to the origin ionites can be divided into natural and synthetic; according to the composition: organic and inorganic. Depending on the charge of exchanging ions and the value of their dissociation constant ionites can be divided into:

1. *Cationites*. They contain strongly dissociated or weakly dissociated acid groups $R-SO_3H$; $R-COOH$; $R-SH$ and others (R - ionite matrix).

2. *Anionites*. They contain functional quaternary alkyl ammonia groups $R-[N(CH_3)_3]^+OH^-$ or $R-[N(CH_3)_2C_2H_4]^+OH^-$; pyridine groups $R-[C_5H_4N(CH_3)]^+OH^-$; amino or imino-groups $-NH_2$; $=NH$; $\equiv N$.

3. *Amphoteric ionites* which contain simultaneously acid and base ionized groups mentioned earlier.

The interaction of ionite with the electrolytic solution is the ion exchange process occurring stoichiometrically. If H^+ cationite in the form of $R-An^-H^+$ (R -cationite matrix, An^- – ionized groups of cationite, H^+ – counterions connected to the ionized groups electrostatically) is led into the solution containing Ca^{2+} ions, there is the ion exchange equilibrium between hydrogen ions transferred into the solution and the equivalent amount of Ca^{2+} ions adsorbed by a cationite:

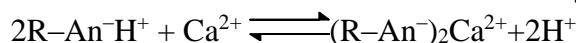

The same exchange process takes place when the solution containing, for example, Cl^- ions with anionite in the form of $OH^- - R-Kt^+OH^-$ (R -anionite matrix, Kt^+ – ionized groups of anionite, OH^- – counterions connected to the ionized groups electrostatically):

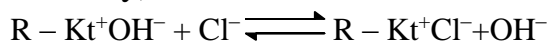

As we can see from these equations there is the change in the reaction medium at the ion exchange: at the cation exchange H^+ - form of a cationite the reaction medium becomes acidic, at anion exchange OH^- form of an anionite the reaction medium becomes alkaline. Reversibility of ion exchange process gives the possibility for the regeneration of a used ionite, i.e. for its reverse transformation into its H^+ or OH^- form. The regeneration of cationites is carried out with the help of acid solutions, and for the regeneration of anionites – alkaline solutions.

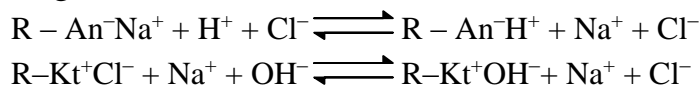

The adsorption ability of electrolyte ions on the ionite depends on their charge. The greater is the ion charge, the greater is its adsorption ability. For example, ions are arranged in the following row $K^+ < Ca^{2+} < Al^{3+} \ll Th^{4+}$ according to the increase in their adsorption ability on the cationite.

Among the ions with the same charge the maximum ion exchange ability is exhibited by those having a smaller radius in the solvated (hydrated) state:

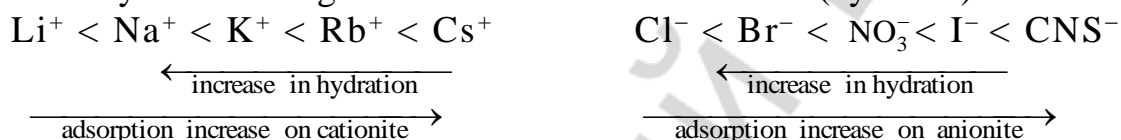

The most important characteristic of the ionite is the *exchange capacity (EC)*. Exchange capacity is the amount of exchanging ions in 1 gram of absolutely dry ionite or in 1 mL of swelled ionite per ions situated in the solution. Natural ionites have EC equal to 0,2–0,3 millimole/gram, synthetic ionites – 3,0–5,0 millimole/gram, sometimes even 10,0 millimole/gram.

The characteristic property of dry ionites is their swelling when contacting with the solution. The greatest swelling can be observed at synthetic ionites and ionites on the polysaccharide basis. The main reason for swelling of ionites in water is the presence of hydrophilic functional groups. The swelling process increases the rate of ion exchange and is directly connected to kinetic characteristics of ionites, especially organic ones.

The usage of ionites. The deionization of water is carried out with the help of ionites. Water is firstly passed through the cationite filter and then through the anionite one.

At the cationite filter there is the adsorption of metal cations from water:

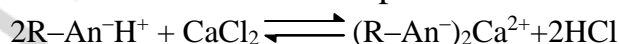

Water containing chloride ions (Cl^-) goes through the anionite filter which changes hydroxide ions (OH^-) into chloride ions (Cl^-):

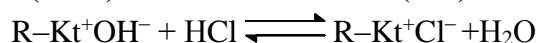

In the result of it we obtain desalinated water.

To produce high quality food products it's necessary to carry out ion exchange and sorption processes on ionites. In sugar industry ionites are used to

reduce the rigidity of sugar solutions, for juice settling and its fine cleaning, for increasing the sugar yield and improving its quality, for obtaining glutamic acid from wastes of sugar production. With the help of ionites it's possible to obtain and purify such sweeteners as xylite and sorbite. Ionites are of great importance for wine making first of all for the removal of the remains of sulphurous acid from grape and fruit juice and for refining of champagne wines. Ionites are also widely used for refining of citric and other acids, gelatin, glycerin, lactose, agar-agar, vegetable oil and other food products.

On the basis of ion exchange materials we can create different medicines of long-term action connecting this way a biologically active or medicinal substance with the ionite. Immobilized enzymes can be used for carrying out different complex catalytic reactions passing a solution or a biological fluid through the column with sorbent without the loading of a catalytic substance into the reaction medium.

11.5. EXCLUSION CHROMATOGRAPHY

At the base of exclusion chromatography there is a principle of division of a mixture of substances according to their molecular size and molecular mass. Exclusion chromatography is divided into gel penetrating and gel filtration.

In gel penetrating chromatography the division is based on the polymers swelling in organic solvents; in gel filtration polymers swelling in water (sephadexes, polyacrylamide gel) are used.

To separate the proteins the gel on basis of dextran or polyacrylamide is used. Gel grains contain pores of a certain size (fig. 11.5a).

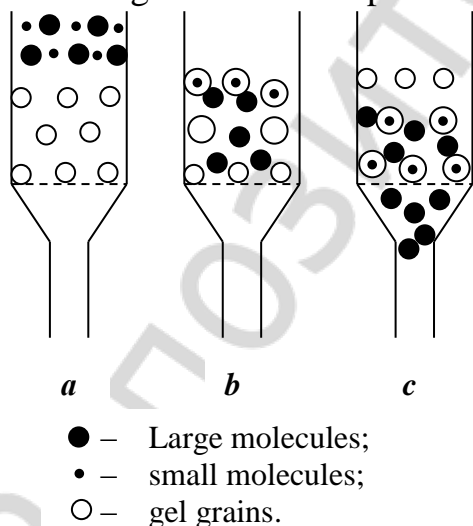

Fig.11.5. The scheme of carrying out exclusion chromatography. Explanations are in the text

Large molecules of the separated mixture of substances will be moving quickly along the column without penetrating inside the grains but smaller ones penetrating into all grain pores will be moving slower (fig. 11.5b) when the column is washed away with a solvent the larger molecules of the substance will be moving first (fig. 11.5c).

The separation of the mixture is more effective with greater difference in

the molecule size of these substances, i.e. in greater difference in the distribution coefficient K.

Exclusion chromatography methods are used for refining of proteins and enzymes from low-molecular inorganic substances, for the determination and division of biopolymers according to their molecular masses.

11.6. AFFINE (BIOSPECIFIC) CHROMATOGRAPHY

Affine chromatography is a method of refining and separation of proteins based on their selective interaction with a ligand connected to the inert carrier (immobilized ligand) by a covalent bond. As ligands it's possible to use compounds the interaction of which with the separated substance is based on the biological function of the latter. So, the enzyme is bonded with the substrate, antigen with antibody, hormone with its receptor (fig. 11.6).

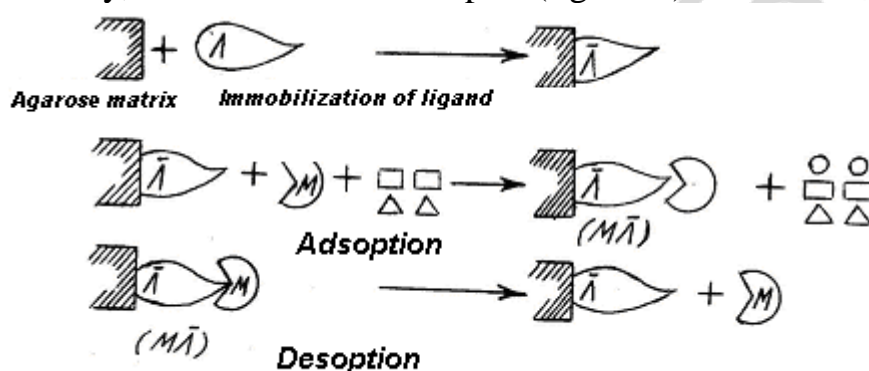

Fig.11.6. Affine chromatography method: Λ is a ligand; $\bar{\Lambda}$ is an immobilized ligand; M is a biologically active substance; $M\bar{\Lambda}$ is a biospecific complex; $\square\Delta$ admixtures, O are the non-sorbent mixture components.

In medical practice the enzyme plasmin participating in the splitting of grumes is used for treatment and prevention of vessel thrombosis. To obtain this enzyme we should do the following. Plasmin is known to be closely bonded with lysine. That's why lysine (ligand) is made to be bonded covalently with polysaccharide matrix and is placed in the column. Blood plasma is passed through the column. At the same time plasmin is bonded with lysine and remains in the column while all the remaining plasma proteins go out. At the base of the bond between plasmin and lysine there is the electrostatic interaction, that's why in order to destroy the complex plasmin-lysine and to obtain pure plasmin, a solution possessing high ionic force is passed through the column.

For obtaining pure antidiphtheritic toxin antibodies from blood serum its antigens are covalently bonded with the cellulose matrix and are placed in the column. Immune serum, which antibodies (biologically active substances) are closely bonded with antigens, is passed through the column. Further washing away of forming immunosorbent by the solution of sodium

chloride of 0,85% by mass removes all nonspecific proteins of blood serum. When the column is washed by phosphate citric buffer solution with pH 3,2, pure antibodies are slivered. The same method can be applied to obtain anti-flu antibodies from blood serum.

CHAPTER 12

Dispersion Systems

Dispersion system is a heterogeneous system containing one or two substances in the form of particles spread in the medium made of another substance. Dispersion system consists of a dispersed phase (DP) and a dispersion medium (DM).

The dispersed phase is a split substance. The dispersion medium is a medium where this split substance is spread.

Dispersion means splitting. Every substance can exist both in the form of a monolith and a split substance (flour, small bubbles, small drops). The substance splitting of a dispersed phase is characterized by the degree of dispersion (δ) which is opposite to the medium diameter of (d) particles:

$$\delta = 1/d, \text{ m}^{-1}$$

Clouds, fumes, soil, clay are the examples of dispersion systems. Biological fluids such as blood, urine, lymph, cerebrospinal fluid are also dispersion systems where different inorganic and organic salts: phosphates, oxalates, urates, carbonates can be found in colloidal state.

12.1. THE CLASSIFICATION OF DISPERSION SYSTEMS

I. According to the dispersion degree of particles of the dispersed phase.

1. **Coarsely dispersed.** These are the systems in which the particles have the size of $10^{-7} \text{ m} - 10^{-4} \text{ m}$.

2. **Colloid-dispersed.** The size of particles is $10^{-7} \text{ m} - 10^{-9} \text{ m}$. Particles consist of molecules, ions, or can have the form of a macromolecule. Any substance can be obtained in the colloid state. For example, soap in water is a colloid solution; soap in alcohol is a true solution. Colloid solutions with liquid dispersion medium are called sols.

3. **Systems with the particle size less than 10^{-9} m** are not referred to as dispersed ones. Such particles form molecular (particle diameter 10^{-10} m) and ionic (10^{-11} m) solutions known as **true solutions**.

II. According to the aggregative state of the phase and the medium.

Depending on the aggregative state of a dispersed phase and the dispersion medium we can divide all dispersion systems into 8 types (table 12.1).

Types of dispersion systems

Aggregative state of the dispersed medium	Type of the system	Aggregative state of the dispersed phase	Symbolic notation of the system	Examples of systems
Gas	Aerosol	Liquid Solid	L/G S/G	Mist. Fumes, dust, powder.
Liquid	Lyosol	Gas Liquid Solid	G/L L/L S/L	Foam. Emulsions(oil, milk). Slurries, suspensions Colloid solutions.
Solid	Hard sol	Gas Liquid Solid	G/S L/S S/S	Hard foams(pumice, bread). Capillary systems(liquids in porous objects, soil, ground). Hard systems(minerals, alloys, concrete).

In the designations like S/S, S/L first goes the state of DP and then DM. The type G/G can't be a dispersion system because of mutual solubility of all the gases.

III. According to the kinetic properties of the dispersed phase. Dispersion systems can be differed according to the degree of interaction of particles in the dispersed phase. If DP particles are not connected with each other and are able to move independently in DM under the influence of thermal motion or force of gravity, such systems are called free-dispersion systems. These are lyosols, aerosols, rather diluted suspensions and emulsions. If the particles are bonded together by the intermolecular interaction forces and form spatial patterns (lattices, nets, etc), such systems are called bound-dispersion systems. These are gels, concentrated suspensions (creams, pastes) and concentrated aerosols.

IV. According to the character of interaction between the dispersed phase (DP) and the dispersion medium (DM).

We should distinguish lyophilic and lyophobic systems. Lyophilic systems are those where DP particles are very similar to those of DM and lyophobic systems are those with little similarity of DP and DM particles. If water is taken as DM, then we should use the terms 'hydrophil(ic) and hydrophobic dispersion systems'. The examples of a hydrophilic system can be high-molecular compounds (HMC) like proteins, polysaccharides, nucleic acids. The majority of dispersion systems are lyophobic (hydrophobic). For example, metal sols in water, sols of AgCl, BaSO₄ salts etc.

12.2. THE STRUCTURE OF COLLOID(AL) PARTICLES

To obtain a dispersion system (including colloid solutions) we should observe three conditions: firstly, mutual insolubility of the dispersed phase and the dispersion medium; secondly, the substance should be split to a certain size of

DP particles; thirdly, presence of a stabilizer. As a stabilizer there are ions which are adsorbed at the surface of particles.

The appearance of the charge on the colloid particle is connected with the fact that at the surface of colloid particles there is a double electric layer formed at the interface of phases. The necessary condition for the charge formation at the colloid particle is the excess of one of the electrolytes taking part in the reaction. It is known that if we pour together two solutions of electrolytes in equivalent amounts, there will be no colloid solution formed but there is the precipitate:

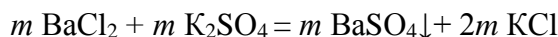

Suppose, we have to obtain BaSO_4 sol. In this case one of the electrolytes should be taken in excessive amount. Let's assume that the reaction occurs at the excess of BaCl_2 solution. Let's write the scheme of the reaction:

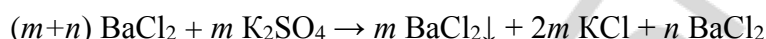

As barium chloride is a strong electrolyte, it decomposes completely into ions:

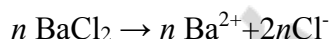

The basis of colloid particles is the microcrystals of a slightly soluble BaSO_4 (ion pairs of Ba^{2+} and SO_4^{2-} to be exact).

These microcrystals are called the aggregate. If the reaction occurs at the excess of BaCl_2 solution, there is a positively charged layer at the surface of the aggregate which appears as a result of selective adsorption of Ba^{2+} ions. This occurs according to Panett-Fayance rule which states that the lattice structure can be finished only by those ions which are a part of it. Barium ions Ba^{2+} in this case are **potential-determining ions**. The aggregate together with the potential-determining ions is a part of a solid phase and is called a nucleus.

Under the influence of electrostatic forces $2n$ chlorine ions are attracted to the nucleus. They are called **counterions** and they compensate the nucleus charge. Part of these counterions ($2n-x$) is strongly attached to the nucleus and together with potential-determining ions Ba^{2+} form the **adsorption layer**.

The aggregate and the adsorption layer together form a granule which has a positive charge. The rest x of chlorine counterions forms a diffuse layer. The granule together with the diffuse layer of counterions forms a micelle which is electrically neutral. The micelle scheme can be drawn in the following way:

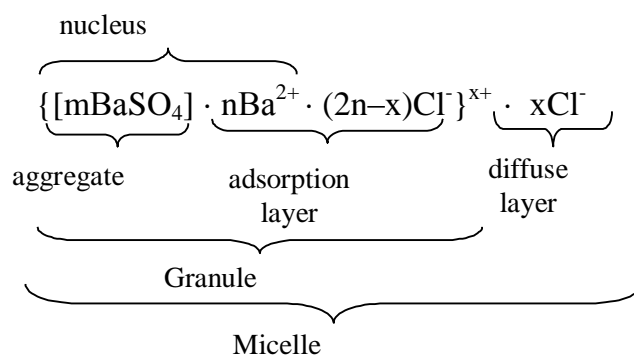

Micelle is separate colloid particles which form the sol dispersed phase.

In the case when the solution of potassium sulfate K_2SO_4 is taken in excess amount, the micelle scheme will be different:

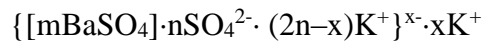

The granule charge is determined by the charge of potential-determining ions. The granule becomes neutral if all the counterions from the diffuse layer transfer to the adsorption layer:

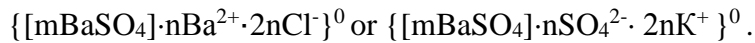

The potential drop between the mobile and immobile (adsorption) parts of the double electric layer is called electrokinetic potential or ξ zeta potential and is calculated using the formula:

$$\xi = \frac{V \cdot K \cdot \pi \cdot \eta}{H \cdot \varepsilon},$$

where K is the coefficient, the value of which depends on the form of particles: $K=4$ for cylindrical, $K=6$ for spherical; V is the linear speed of particle transfer (of the sol borders), m/sec; η is the viscosity of the medium, Newton·sec/m²; H is the electric field intensity (potential gradient), V/m; ε is the relative dielectric permittivity of the medium.

ξ -potential depends on the blurring degree of diffuse layer, electrolyte concentration and ion charges.

Maximum potential drop between the solid surface and all other counterions is called thermodynamic potential E ($E=1V$). The value of thermodynamic potential is 30-100 mV.

12.3. THE STABILITY AND COAGULATION OF DISPERSION SYSTEMS

Stability of a dispersion system is the constancy of this system in time, first of all the constancy of dispersion and the constancy of even particle distribution of dispersed phase in the medium. We should distinguish two kinds of stability of dispersion systems: sedimentation (kinetic) and aggregative. Sedimentation stability is the ability of particles of a dispersed phase to remain in the suspension state. This ability depends on the dispersion degree of particles, dispersed phase viscosity, differences in the density of the dispersed phase and the dispersion medium, temperature. Kinetic (sedimentation) stability of the sol is the higher when the smaller is the particle size, the closer are the values of phase density and medium and the higher is the dispersion medium viscosity while the dispersion degree of particles is the most influential characteristic. That's why highly dispersed structures where the deposition rate of suspended particles under the influence of force of gravity is small enough to be neglected are called sedimentation (kinetically) stable.

Aggregative stability characterizes the ability of particles from dispersed phase to show resistances to their adhesion and in this way to keep a definite de-

gree of dispersion. The main factors of aggregative stability of dispersion systems are the following: particles have an ionic shell, i.e. double electric layer, the diffuse layer of counterions and also their solvation (hydrated) sphere. The loss of aggregative stability leads to coagulation.

Coagulation is the process of joining of colloid particles and forming of greater aggregates which leads to their precipitation under the influence of the forces of gravity followed by further phase division. Coagulation can be caused by different factors: change in temperature, action of light, mechanical influence, irradiation, the increase in sol concentration, adding of electrolytes.

The change in temperature can influence the kinetic and aggregative stability and, consequently, coagulation in different ways. The kinetic stability with the increase in temperature increases too in the result of intensification of Brownian motion, the aggregative stability decreases in the result of reducing of thickness of the diffuse layer. At the same time the possibility of particle collision (adhesion) increases, which favours the coagulation.

The coagulation by electrolytes is studied most all and has great practical value. Electrolytes, on one hand, are necessary for sol stability but, on the other hand, their excess in the solution causes coagulation. That's why those colloid solutions obtained by chemical methods must be purified from admixtures of electrolytes.

12.4. COAGULATION OF COLLOID SOLUTIONS

For the coagulation process to begin it's necessary to have some small concentration of electrolyte in the sol. This smallest amount of electrolyte which causes coagulation of 1liter of sol is called the coagulation threshold. It is determined by the turbidity and the change in colour of colloid solution and is calculated using the formula:

$$\gamma = \frac{C \cdot V}{V_0},$$

where γ is the coagulation threshold, mol/L; C is the electrolyte concentration, mol/L; V is the volume of electrolyte solution, L; V_0 is the sol volume, L. The coagulation threshold can be calculated in millimol/L.

The value, reciprocal to the coagulation threshold ($1/\gamma$) is the measure of electrolyte coagulation ability: the smaller is the coagulation threshold, the higher is the coagulation ability of electrolyte.

Coagulation is caused by the ion which charge is opposite in sign to the surface charge of colloid particles. The coagulation of positively charged sols is caused by anions of the added electrolyte, of negatively charges sols – by cations of electrolyte. Coagulation action of electrolytes is determined by Schulze-Gardi rule that reads: «Coagulation action is caused by a counterion and the coagulating ability increases progressively to some high degree of its charge». If the coagulation is caused by ions with the same sign but of different charge,

their coagulation thresholds are related as the values reciprocal to their charges to the power of 6:

$$\gamma_{+} : \gamma_{2+} : \gamma_{3+} = \frac{1}{1^6} : \frac{1}{2^6} : \frac{1}{3^6} = 730 : 11 : 1$$

As coagulation threshold depends not only on the nature of ion-coagulant but also on the nature of the ion accompanying it, and on the conditions of the conducting of the experiment. In practice we can observe the deviations from the indicated ratio. At present it is known that the coagulation threshold is proportionate to the charge of ion-coagulant to the power of ranging from 2 till 9, often to the power of 6. Ions with the same sign and charge have very slight differences in the coagulation thresholds.

The phenomenon of coagulation by electrolytes plays a great role in the living organism as colloid solutions of cells and biological fluids contact with electrolytes. That's why at the introduction of some electrolyte in the organism we should take into account not only its concentration but the ion charge. For example, saline of sodium chloride can't be substituted by isotonic solution of magnesium chloride because this salt contains a divalent ion of magnesium exhibiting a higher coagulating property.

12.5. KINETICS AND COAGULATION MECHANISM BY ELECTROLYTES

Coagulation of any colloid solution doesn't take place immediately, it takes some time. The process of coagulation can be judged by the changes in the optical properties of the solution.

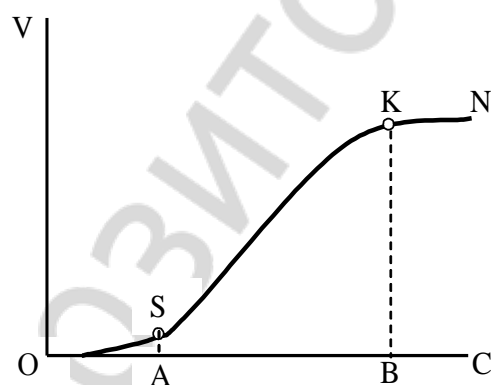

Fig. 12.1. The dependence of coagulation rate on the electrolyte concentration. Explanations are in the text

We should distinguish two stages of coagulation: latent and explicit. During the first stage we can see the enlargement of particles without any vivid changes in the optical properties of the solution (latent coagulation). During the second stage we can observe the further enlargement of particles accompanied by explicit changes in sol. (explicit coagulation).

At fig. 12.1 we can see the curve (OSKN) which reflects the dependence of the sol coagulation rate on the concentration of the added electrolyte. The segment OS corresponds to latent coagulation and point A is the electrolyte concentration at coagulation threshold which can be fixed. The characteristic of explicit coagulation is the sol turbidity and the change in its colour.

At the beginning of explicit coagulation (segment SKN) its rate is small. But with the increase in electrolyte concentration the rate is increased too. That's why we should distinguish slow (SK) and quick (KN) coagulation. Point B corresponds the electrolyte concentration at some residual value of ξ - potential (in scientific literature it is called the critical potential).

There are different theories describing coagulation mechanism. According to one of the theories at introducing of electrolyte in the dispersion system there is the contraction of ion shell of particles owing to the selective or ion exchange adsorption at the surface of ions of the given electrolyte. At the same time the particle charge, its ξ -potential and, consequently, the thickness of the diffuse layer are decreased. The decrease in the thickness of the diffuse layer leads to the prevalence of intermolecular attraction forces over the electrostatic repulsion forces in the result of which the coagulation rate increases.

12.6. SOL COAGULATION BY MIXTURES OF ELECTROLYTES

Sol coagulation can also be caused by electrolyte mixtures which can influence it in many ways (fig. 12.2).

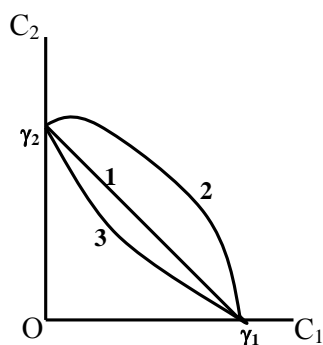

Fig.12.2. Coagulation by electrolyte mixtures:
 curve 1 – additive action;
 curve 2 – antagonism;
 curve 3 – synergism

1. The coagulating action of electrolyte mixture is summed up, i.e. the mixture of electrolytes acts in the same way as one of them taken in the same amount. It's an **additive action**.

2. The coagulating action of electrolyte mixture is less than each of them taken separately, i. e. for the sol coagulation it is necessary to take bigger amount of mixture than the quantities of each of them taken

separately. It's **antagonism**. It's characteristic for ion mixtures having different valence.

3. The coagulating action of electrolyte mixture is greater than each of them taken separately, i.e. for the sol coagulation it is necessary to take smaller amount of mixture than the quantities of each of them taken separately. It's **synergism**.

All above mentioned phenomena are very important for understanding of regularities of ion influence on the organs and tissues of a living organism as biologically active ions often play the role of «antagonists» or «synergists». This circumstance should be taken into account while preparing blood substituting solutions: they must be not only isotonic to blood plasma and have equal ionic force but should be extremely close to each other in ionic composition. But these described phenomena can't be mixed up with the phenomena of physiologic ion antagonism which can be understood as the weakening by one cation of a toxic or a physiologic action caused by the other one.

12.7. COLLOID PROTECTION

The stability of colloid solutions can be increased using not only small amount of electrolyte but adding to it high molecular compounds (HMC). The increase in the stability of a colloid solution when adding to it HMC is called colloid protection. This phenomenon can be seen in the increase of coagulation threshold. For example, if we add a small amount of gelatin solution into sol of iron (III) hydroxide, it will require much more electrolyte for the sol coagulation than for the coagulation of an unprotected sol.

The mechanism of protective action is based on the formation of adsorption shell from HMC molecules around the colloid particle while these molecules form a structural and mechanical barrier preventing the particles from adhesion. At the same time not only aggregative but sedimentation sol stability is increased as a result of the increasing viscosity of dispersion medium.

Colloid particles protected by a protein layer are stable and according to their properties don't differ from protein macromolecules. The example of such dispersion systems can be medicinal bactericidal drugs as protargol, collargol which are sols of metallic silver protected by proteins. These medicines acquire stability which is preserved even at complete removal of dispersion medium. It should be noted that bactericidal action typical of heavy metals isn't shielded by protein shell.

Such biological liquids as blood, plasma, lymph, cerebrospinal fluid are the systems where some of their constituent parts are in colloid state, for example, phosphates, urates, oxalates, carbonates, cholesterol, and lipids. In blood crystals of slightly soluble compounds don't precipitate because they are protected from coagulation by proteins. According to one of the theories with age the immune [protective] function of proteins in the organism is decreased and many diseases as atherosclerosis, calcinosis, podagra, formation of calculus in kidneys and liver and so on begin to appear.

CONTENTS

Preface.....	3
Chapter 1. Basic concepts about the structure of matter.....	5
1.1. The electron shell of the atom	5
1.2. The quantum numbers	7
1.3. Electron configurations of elements.....	11
1.4. The periodic table. Atomic properties and periodic trends.....	16
Chapter 2. Chemical Bond	18
2.1. Valence electrons	18
2.2. Ionic bond.....	19
2.3. Chemical bond formation.....	20
2.4. Properties of Covalent Bond	21
2.5. Theories of chemical bonding	27
Chapter 3. Chemical Thermodynamics.....	34
3.1. Terminology of chemical thermodynamics	34
3.2. Energy. Internal energy	36
3.3. The first law of thermodynamics.....	38
3.4. Thermochemistry	40
3.5. Hess's law.....	41
3.6. thermochemical calculations and their using for characteristics of biochemical processes.....	43
3.7. The second law of thermodynamics.....	44
3.8. The statistical interpretation of entropy	48
3.9. The thermodynamical interpretation of entropy	48
3.10. The gibbs free energy	49
3.11. Bioenergetics. Endergonic and exergonic reactions	53
3.12. Thermodynamics of the chemical equilibrium	54
3.13. The equation of the isotherm of a chemical reaction	56
3.14. The equation of the isobar of a chemical reaction.....	57
3.15. Le chatelier principle.....	58
Chapter 4. Chemical Kinetics	59
4.1. Basic Concepts of chemical kinetics, simple and complex reactions	59
4.2. Rates of reactions	60
4.3. Factors influencing the rate of a reaction.....	61
4.4. Classification of the reactions in order.....	63
4.5. Half-life of a reaction	65
4.6. Molecularity	65
4.7. The effect of temperature on the rate of chemical reaction	67
4.8. Collision theory.....	67
4.9. Concept about kinetics of complex reactions	70
4.10. Catalysis and catalysts.....	74
4.11. Enzymes	75

Chapter 5. Solutions and Their Properties.....	80
5.1. Thermodynamics of the process of solution formation	80
5.2. The ideal and non-ideal solutions	82
5.3. Colligative properties of solutions	83
5.4. The second raoult's law	84
5.5. Osmosis	85
5.6. Electrolyte solutions.....	88
Chapter 6. Acid-Base Equilibrium	93
6.1. Development of the acid-base concept	93
6.2 The water ionization constant, k_w	96
6.3 Acidity and basicity of aqueous solutions. the ph scale	96
6.4 PH calculation in aqueous solutions of weak acids and bases.....	98
6.5 PH calculation in aqueous solutions of strong acids and strong bases	99
6.6. Acid-base status of a human body	99
6.7. The role of hydrogen ions in biological processes	100
6.8 Buffer solutions.....	101
6.9. Buffer systems of blood	103
Chapter 7. Complex (Coordination) Compounds.....	106
Chapter 8. Heterogeneous Equilibria	112
Chapter 9. Electrochemistry	121
9.1. Absolute ion movement rate	121
9.2. Specific electrical conductivity.....	123
9.3. Molar electrical conductivity	124
9.4. Conductometry.....	126
9.5. Theory of origin of electrode and oxidation reduction potentials	128
9.6. Galvanic cells.....	130
9.7. Standard hydrogen electrode.....	132
9.8. The glass electrode.....	133
9.9. Oxidation-reduction potentials.....	135
9.10. Spontaneity of redox reactions.....	136
Chapter 10. Physico-Chemistry of Surface Phenomena	138
10.1. Surface energy and surface tension.....	138
10.2. Adsorption at the mobile interface of phases.....	141
10.3. Orientation of SAS molecules in the surface layer. Structure of biological membranes	142
10.4. Adsorption at the immobile interface of phases (at the surface of a solid).....	143
Chapter 11. Chromatography and Its Types.....	147
11.1. Thin layer chromatography	148
11.2. Elements of the kinetic theory of elution chromatography	151
11.3. Adsorption chromatography	152
11.4. Ion exchange chromatography	152

11.5. Exclusion chromatography	155
11.6. Affine (biospecific) chromatography	156
Chapter 12. Dispersion Systems	157
12.1. The classification of dispersion systems	157
12.2. The structure of colloid(al) particles	158
12.3. The stability and coagulation of dispersion systems	160
12.4. Coagulation of colloid solutions.....	161
12.5. Kinetics and coagulation mechanism by electrolytes	162
12.6. Sol coagulation by mixtures of electrolytes	163
12.7. Colloid protection	164

РЕПОЗИТОРИЙ БГМУ

Учебное издание

Ткачѐв Сергей Викторович
Латушко Татьяна Викторовна
Казюлевич Светлана Ричардовна
Барковский Евгений Викторович

ОСНОВЫ ХИМИИ ДЛЯ ИНОСТРАННЫХ СТУДЕНТОВ

ESSENTIAL CHEMISTRY FOR FOREIGN STUDENTS

Учебно-методическое пособие

На английском языке

5-е издание

Ответственный за выпуск В. В. Хрусталѐв
Переводчики С. Ч. Папук, С. В. Ткачѐв
Компьютерный набор О. И. Смирновой
Компьютерная верстка А. В. Янушкевич

Подписано в печать 20.06.18. Формат 60×84/16. Бумага писчая «Снегурочка».

Ризография. Гарнитура «Times».

Усл. печ. л. 9,76. Уч.-изд. л. 9,18. Тираж 200 экз. Заказ 506.

Издатель и полиграфическое исполнение: учреждение образования
«Белорусский государственный медицинский университет».

Свидетельство о государственной регистрации издателя, изготовителя,
распространителя печатных изданий № 1/187 от 18.02.2014.

Ул. Ленинградская, 6, 220006, Минск.

Репозиторий БГМУ