

МИНИСТЕРСТВО ЗДРАВООХРАНЕНИЯ РЕСПУБЛИКИ БЕЛАРУСЬ
БЕЛОРУССКИЙ ГОСУДАРСТВЕННЫЙ МЕДИЦИНСКИЙ УНИВЕРСИТЕТ
КАФЕДРА ПАТОЛОГИЧЕСКОЙ ФИЗИОЛОГИИ

ПАТОЛОГИЧЕСКАЯ ФИЗИОЛОГИЯ

PATHOLOGICAL PHYSIOLOGY

Сборник ситуационных задач и дополнительная информация
к практическим занятиям



Минск БГМУ 2010

УДК 616–092 (811.111) (075.8)
ББК 52.5 (81.2 Англ – 923)
П 20

Рекомендовано Научно-методическим советом университета в качестве
сборника ситуационных задач 20.01.2010 г., протокол № 5

А в т о р ы: Ф. И. Висмонт, В. А. Касап, С. А. Жадан, А. А. Кривчик, Е. В. Леонова, Т. В. Короткевич, Л. С. Лемешонок, А. В. Чантурия, Т. А. Афанасьева, В. Ю. Перетяцько, О. Г. Шуст, Н. А. Степанова, К. Н. Грищенко, Э. Н. Кучук, Д. М. Попутников

Р е ц е н з е н т ы: член-корр. НАН Беларуси, д-р мед. наук, проф. каф. нормальной физиологии Л. М. Лобанок; д-р мед. наук, проф. каф. патологической анатомии М. К. Недзьведзь

Перевод на английский язык Т. Ф. Даниловой, С. А. Жадан

Патологическая физиология = Pathological physiology : сб. ситуац. задач П 20 и доп. инф. к практ. занятиям / Ф. И. Висмонт [и др.] ; пер. на англ. яз. Т. Ф. Данилова, С. А. Жадан. – Минск : БГМУ, 2010. – 174 с.

ISBN 978–985–528–184–0.

Представлены ситуационные задачи, блоки дополнительной информации теоретического характера, предназначенные для лабораторных занятий по патологической физиологии.

Предназначен для студентов 2–3-го курса медицинского факультета иностранных учащихся для самостоятельной подготовки к занятиям.

УДК 616–092 (811.111) (075.8)
ББК 52.5 (81.2 Англ – 923)

ISBN 978–985–528–184–0

© Оформление. Белорусский государственный
медицинский университет, 2010

GENERAL NOSOLOGY

LESSON 1. INTRODUCTORY LESSON. THE SUBJECT, TASKS, METHODS OF PATHOLOGICAL PHYSIOLOGY

SAFETY PRECAUTIONS INSTRUCTING

General requirements

1. The students should wear white gowns in academic rooms.
2. The working place should be kept clean, not blocked up with utensils, the devices unnecessary at present, extraneous subjects: clothes, bags, etc. Upon termination of work all devices should be taken away into the cupboard.
3. While working in the laboratory it is necessary to keep quiet, order and cleanliness, to exclude any haste, disorder and untidiness.
4. The students are forbidden to work in the laboratory without supervision of the teachers or laboratory assistants as well as during unscheduled time without permission of the teacher.
5. In the laboratories it is strictly forbidden to do works that are not envisaged by the curriculum.
6. The students can start doing each work only having got safety precautions instructing and permission of the teacher.
7. Having completed the work it is necessary:
 - to put the workplace in order;
 - to switch off water and an electricity.
8. During practical classes the students should strictly observe general rules of working with electric devices and the lighting equipment. On revealing naked wires, faulty electric sockets, etc. immediately inform the teacher and the laboratory assistant about it. Take necessary safety measures to prevent casual contact of those who work with faulty devices and electric wiring.
9. Before connecting the electric device to the power (an electrocardiograph, electrokymograph, electrostimulator) check up their grounding together with the teacher and the laboratory assistant.
10. At the lesson devoted to studying the effect of the lowered atmospheric pressure on the organism, while working with Komovsky's pump, it is necessary to check up carefully the integrity of glass caps together with the laboratory assistant. If any defects are revealed, the experiment should not be carried out or should be stopped. After the completion of the experiment the air should be let in under the cap slowly to prevent possible injury of nearby classmates.
11. Practical modeling of Danilevsky's experiment on «Phagocytosis» is carried out only by the teacher or laboratory assistant; safety measures should be observed while working with concentrated acids.

12. While working with mercury on the topic «Phagocytosis» etc. it is necessary to observe the precaution rules to prevent loss of mercury and a possibility of its getting into the organism.

13. While working with ether it is necessary to remember, that it refers to inflammable and explosive substances. Used cotton wools moistened with ether should be disposed only in hermetically sealed capacities.

14. Having completed the experiment it is necessary to air the room. It is not allowed to work with ether near the sources of open flame and heating devices. Working with ether is carried out only in the presence of the teacher.

Safety rules while working with electric devices

While work with electric devices (slide projector, power unit for the microscope, etc) an electric injury or a fire may occur. While working with electric equipment and electric devices it is strictly forbidden:

- to work with faulty equipment;
- to work with unearthed devices, if it is not specified in the maintenance instruction;
- to break the maintenance instruction of the device;
- to touch current carrying parts of devices with hands or metal subjects;
- to check the presence of voltage in the network without special devices;
- to replace safety fuses for self-made ones;
- to hang up various things on plug sockets, wires and switches;
- to strengthen wires or tightness of contacts by a cord or any other improvised materials;
- to leave switched on electric devices without supervision.

After acquaintance with safety precaution rules put your signature at the end of the report as well as in the Chair register «Safety precautions instructing register for the students» certifying that you have received and acquired safety precautions instructing.

Responsibilities of the student on duty during laboratory classes:

1. The student on duty, appointed by the monitor of the group before the lesson, checks the sanitary condition of the laboratory, its readiness for the lesson. If any troubles are revealed, he informs the laboratory assistant or the teacher about it.

2. If necessary, he receives albums, methodical instructions, atlases and other manuals for the lesson in room № 126 on his student's card. After the lesson the manuals are returned to that laboratory room.

3. If necessary, he helps the supervising laboratory assistant or the teacher in demonstrating slides, performing demonstrative works, etc.

After the lesson he again checks the sanitary condition of the laboratory and, if necessary, helps his classmates and the laboratory assistant to clean working places. The duty is considered completed, when the laboratory assistant or the teacher «takes over» the laboratory after the lesson.

LESSON 2. ETIOLOGY AND PATHOGENESIS. PATHOGENIC ACTION OF ENVIRONMENTAL FACTORS. ELECTROTRAUMA

SITUATIONAL TASKS

№ 1

While repairing the power transmission line in the village of Ostrov in Dobrudzhskaya area in Romania, Ion Zhianu, the chairman of the cooperative society, had received a severe electrocution and had been under electric tension for some minutes unless the line was switched off. The attempts to save him, to bring him into consciousness were of no success. Neither pulse, nor breath was revealed.

Zhianu's body was brought into the house. Twelve hours later the relatives who have gathered to see Ion off to the last way, were shocked: the «dead man» lifted at first one hand, then the other, then stood up and looked around ...

Soon he took over his duties of the cooperative chairman and now makes jokes with his villagers on his «revival».

1. What condition has developed in I. Zhianu under the action of electric current?
2. Specify the difference between a shock, clinical and imaginary death.

№ 2

Sanitary technician Ya., 29 years, was repairing a pipe of the steam heating in the basement. The floor of the basement was covered with water. The sanitary technician wore rubber boots as due to his occupation he had to work frequently in damp rooms with damp soil floor. He switched on an electric lamp to illuminate the place of accident and casually touched a naked part of the cord. He felt the current action, but could not unclasp his fingers, grasping the cord. He gave a shout and lost consciousness. His fellow-worker standing nearby pulled out the plug from the socket. In 20 min after the trauma the ambulance surgeon rendered the first aid and then delivered him to the Clinic of field surgery at the Military medical academy named after S. M. Kirov. On admission the victim's condition was satisfactory. The palm of his left hand had electric signs at the base of the IV finger and in the area of the 3-rd interdigital fold.

1. What was the cause of an electric trauma?
2. Under what voltage (U) does the so-called arresting action of electric current occur?
3. What is the right way of rendering the first aid to the victim in the arresting action of electric current?

№ 3

Patient D., 43 years, was delivered to the clinic of field surgery at the Military medical academy named after S. M. Kirov on the 8-th day after electrocu-

tion in an extremely severe condition. The trauma was received during commissioning of the substation after repair, it being under tension of 10 000 V. On examining the patient and removing the bandages the following was revealed: 1) the absence (tearing off) of the right hand and necrosis of the rest part of the same extremity with an outlined demarcation line extending through the armpit to the shoulder joint area; 2) necrosis of the right leg; the foot was charred; 3) necrosis of the lower part of the left leg; the foot was charred; 4) traces of electric marks on the face, neck and anterior surface of the thorax. Due to severe intoxication by decay products of necrotic tissues of extremities and associated infection on the 3-rd day after admission to the clinic the patient was amputated the right hip at the level of the middle of 1/3, on 8-th day he was amputated the lower 1/3 of the left hip and his right arm was disarticulated in the shoulder joint. Death occurred on the 24-th day after the trauma.

1. What kinds of electric current action resulted in tearing off of the hand and charring of extremities?
2. What severe complication of the burn disease resulted in death of the patient?
3. What mistake was made while treating the patient?

№ 4

Driver L., 18 years, was delivered to clinic in an extremely severe condition: with electrocution associated with mechanical injuries of internal abdominal and thoracic organs. One hour before admission to the clinic, being in the condition of alcoholic intoxication, he climbed up the mast of high-voltage network and grasped the wires under 3500 V. He was thrown back to the ground from high altitude and received a severe injury. The ambulance doctor introduced IV cardiac preparations on the spot, and gave oxygen on the way to clinic.

The victim is unconscious, his respiration is independent, but labored, 28 resp. per minute. Visible mucous membranes are cyanotic. Pulse rate is 120 per minute, arterial pressure of 70/30 mm Hg. Reaction of pupils to light is weak. There is a stellate wound 3×4cm in size in the left parietal area. Hypodermic emphysema is revealed in the thorax, it extending to the area of the right abdominal half till the inguinal fold. Urgent reanimation measures are taken — a puncture of the subclavicular vein, injection of cardiac, antishock and other preparations, tracheal intubation. The patient is administered artificial pulmonary ventilation. On palm surfaces of the right hand, at the base of II finger, is an electric burn 2×1.5 cm in size, the skin of the nail phalanx is charred, the end phalanx is naked. V finger of the left foot is torn off, the articulate surface of the head of the tarsal bone and charred soft tissues are visible at the bottom of the wound. There are skin burns of the II–III degree 8×4 and 7×5 cm in size on the anterior surface of the thorax and the trunk.

Thoraco-laparotomy was made. Bilateral ruptures of the lungs 1.5–2.5 cm in size and a fissure of the diaphragm surface of the liver 4.2×0.2 cm in size were revealed. Stitches were put to the wounds of the liver and lungs. Death occurred in 7 h after the operation.

1. What kinds of electric current action caused a severe injury of the victim?
2. List the signs of electric current injury in this patient.

№ 5

Before storm 7 persons have settled down for rest under a tree. The oak, about 8 m in height, towered above the crowns of other trees a little, but it was enough for the lightning to get into it. The bark of the oak was torn off up to 2 m from the ground. All 7 persons were at a distance of 1.5–3 m from the trunk, of them 6 persons were sitting on the ground, and one was reclined on his back. The lightning has sparkled, and all 7 persons were damaged. The first aid team arrived to the place of accident. One of the injured lost his consciousness, and he was given artificial pulmonary ventilation; the other had a short-term paralysis of lower and upper extremities, in the 3-rd and 4-th — a paralysis of one leg, in the 5-th — the left leg became numb. Only two persons experienced general weakness. In one hour all victims were delivered to hospital. On admission all of them complained of general weakness, burning in the area of body burns on hips, legs, buttocks. Objectively — the condition was satisfactory. Integuments of the face and mucous membranes of the lips were pale. Pulse and respiration were in norm. Uniform revival of tendon reflexes and muscular weakness in legs was marked. Topically — in 5 patients in the area of waists, buttocks and on other sites of a body there were «signs» of burns 0.2–0.3 cm in diameter, burns of II degree in the area of hips and legs. Only one victim didn't have any «signs» of electric current. The last victim, who was reclined during the lightning discharge, had burns of both forearms, shoulders and interscapular area of the II degree, alongside with specified localizations. The electrocardiogram revealed minor changes only in 4 victims. The body temperature in all victims elevated to 37.6 °C on the first day. The leukocyte count — in one victim reached $14 \times 10^9/l$, in the others it was within the norm. ESR in all patients was 15–30 mm per 1 h. Urine was without changes. For 1 week the victims complained of periodic headaches and general weakness, tinkling or numbing of the extremities. Treatment — bed regimen, antibiotics, cardiac preparations, intravenous injections of glucose, polyvitamins and other symptomatic means. All of them were discharged on recovery in 2.5 weeks.

1. What actions of the victims have led to their lightning injury?
2. What was the reason of a short-term paralysis in the victim's extremity?
3. Is it possible to treat victims of lightning out-patiently?
4. What complications on the part of the cardiovascular system can develop in victims after a lightning discharge?

№ 6

Patient C., 25 years, the doctor, during a thunder-storm was sitting in a closed dry room and received an electric injury. The victim fell down and lost consciousness, he had been made artificial respiration for 2 h. Being a doctor, he described his case history in detail. There were earphones on the wall, behind his back, at a distance of 25–30 cm. There was no contact of the patient with the headphones and the wall. The lightning discharge got to the radio wire, which was stretched to the summer residence over the trees. The lightning spark discharge passed through the right shoulder. He wore boots with metal horseshoes on heels. Despite the absence of direct contact with the ground (he rested his feet against the crossbeam of the wooden table), the current broke down the air layer separating the feet from the ground, and discharged in it. The residents of neighboring summer houses saw a sheaf of sparks to escape from sockets of the radio wiring. Within the next two hours after the electroshock the patient marked a complete loss of sensitivity of the whole body integument, except for the left half of the thorax. The victim was treated for a widespread deep skin burn of the back surface of the thorax and lumbar area in hospital of 4.5 months. For many years slightly marked pyramidal phenomena were still marked — a periodically revealed Babinsky's symptom, irregularity of tendon reflexes.

Now, 31 year later, neurotic reactions are revealed, which, according to the patient, are connected with electric injury he had suffered earlier. There are extending large superficial scars on the right shoulder and thorax; there are pulled-in scars of a horse-shoe form and hyperkeratosis on the area of the heels at the site of the current exit.

1. Specify the possible causes of respiratory arrest in patient C.
2. What is the passage way of electric current in this case?
3. What are the peculiarities of electric burns?
4. What is the cause of the residual neurologic phenomena?

№ 7

Electric welder B., 35 years, received an injury during electric welding, when there occurred some malfunction in a three-phase generator with voltage of 380 V. After deenergizing of the knife switch one phase appeared not to be switched off. In attempt to remove the malfunction in the device he casually touched the wire with the right hand and received an electrocution. He couldn't tear off his hand from the detail because of convulsive contractions of fingers; moreover, his forehead was pressed to the case of the generator, so he has received a skin burn of the forehead and deep burns of the hand. The victim was delivered to clinic in a very grave condition. His consciousness is confused, he pronounces meaningless words, tries to get up. Tears off the bandage. Sharp motor and speech excitation. Narcotic and analgetic preparations have been injected. Urgent tracheostomy and others reanimation actions have been taken.

On examination after removal of the bandage the following is established: a widespread burn of the neck, forehead area of the III degree, deep burns of the right hand (III–IV degrees).

On the 8-th day of treatment in clinic the resection of necrotic skin areas was made and underlying tissue on the neck with the area of 15×10×5 cm. The wound bottom was a deep fascia of the neck, common carotid artery and deep jugular vein. In a month the wound in the forehead area was treated that revealed necrosis of the frontal sinus. Multiple openings in the external plate of the frontal bone were made with the cutter without preliminary anesthesia. On the site of 7×5 cm the bone appeared to be necrotized, it was easily crumbled. Further on it was revealed that necrosis of the anterior plate of the frontal bone became more extensive; this plate was removed and the left frontal sinus was opened all along its extent.

Further plastic operations — skin transplantations — have been made. The patient recovered.

1. What condition developed in patient B. on admission to clinic?
2. What are the peculiarities of electrocution of bones?
3. Why wasn't anesthesia made for treating a burn of the frontal bone?
4. Why was the bone easily crumbled in treating the anterior plate of the frontal sinus?

LESSON 3. REACTIVITY OF THE ORGANISM AND ITS ROLE FOR PATHOLOGY. TYPICAL IMPAIRMENTS OF IMMUNOLOGIC REACTIVITY

ADDITIONAL INFORMATION

Classification of immune pathologic conditions

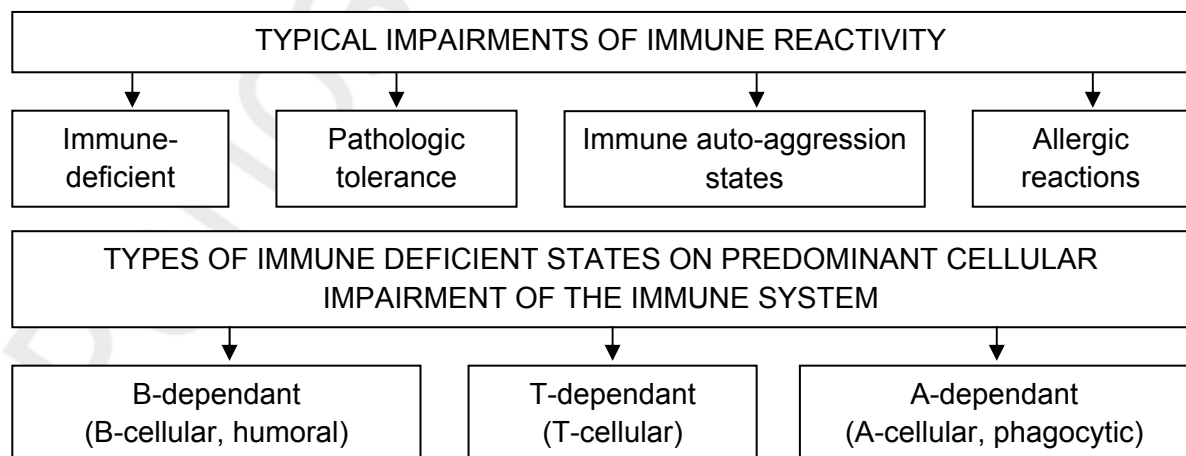

TYPES OF ALLERGIC REACTIONS
(Gell, Coombs, 1968)

Type	Allergen	Characteristics	C*	Ig**	Mediators	Clinic
I Immediate, IgE-dependent	Protein drugs, penicillin, pollen of plants, AH of mites, house dust	allergen interacts with IgE on the surface of mast cells membrane, resulting in the release of mediators	–	IgE	Histamine, leukotriens, prostaglandins, platelet activation factor, hemotoxic factors	Allergic rhinitis, conjunctivitis, bronchospasm, urticaria, Kvinke edema, anaphylactic shock
II Cytotoxic	Amidopyrine, metildofa, furosemide, blood AG of viruses, bacteria, fungi	Allergen on the surface of cells (peripheral blood, epithelium) interacts with serum immunoglobulin, complement system is activated, cytolysis occurs	+	IgM IgE	lysosomal enzymes, anaphylotoxins, hemotoxic factors	Syndromes of Layela, Stevens Johnson, cytopenia
III Immune complex	Serums, vaccines, sulfanilamide, gold preparations, AG of viruses, bacteria	Increased content of immune complexes and allergens. The complexes activate the complement system, resulting in damage of the vascular wall and perivascular cell infiltrates (vasculitis)	+	IgG IgE	lysosomal enzymes, anaphylactotoxins, chemotoxic factors	Serum sickness, vasculitis, glomerulo-nephritis, allergic alveolitis, collagenoses
IV Inhibited	Antibiotics, metals (nickel, chromium), formaldehyde, AG of bacteria, viruses, etc.	Sensitized lymphocytes produce interleukins causing cell infiltration of tissues and output of mediators by inflammatory cells	–	–	Interleukins, chemotoxic factors, lysosomal enzymes	Contact dermatitis, eozinophilic infiltration, formation of granulomas, transplant rejection

V CLASS OF ALLERGIC REACTIONS BY COOMBS AND GELL.
FORMATION OF AUTOANTIBODIES TO CELLULAR RECEPTORS
NON-CELLULAR ELEMENTS, AND BIOLOGICALLY ACTIVE COMPOUNDS

Types of autoantibodies	Clinical manifestations
Autoantibodies to receptors	
a) trigger: – to TTG-receptors; – insulin receptors; – to n-cholinoreceptors of CNS;	Hyperthyroidism Insulin-like effects? Epilepsy?

Types of autoantibodies	Clinical manifestations
b) blocking: – to neuro-muscular -n-cholinoreceptors; – insulin receptors; – to AKTG receptors of adrenal cortical cells; c) the mechanism is unknown: – to CNS synapses	Myasthenia gravis Insulinrezistentnaya form of diabetes Addison disease Schizophrenia, chorea, parkinsonism, scattered (multiple) sclerosis?
Autoantibodies to non-cellular structures	
a) to basal membranes: – renal glomeruli; – renal canaliculi; – skin; b) to intercellular dermal structures	Nephrotoxic glomerulonephritis, Goodpascher's syndrome Interstitial nephritis? Pemphigus and similar forms, herpetiform dermatitis Pemphigus
Autoantibodies to extracellular biologically active compounds	
IgG Erythropoietin Factor VIII F (II, V, IX, X, XI, XIII) Insulin Thyreoglobulin Lipoprotein: – Lipid component; – Protein component Heparin Transferrin Internal factors of Castle Gastrin	Arthritis, vasculitis Anemia Haemophylia Hemorrhagic diathesis Insulinresistant form of diabetes Thyroiditis Hyperlipidemia Hypolipidemia Hyperlipidaemia Hypersiderosis Pernicious anemia Reduced acidity

Factors that increase non-specific resistance	
In preserving or enhancing the vital activity of SNIR (state of non-specific increased resistance)	When vital activity is decreased, the ability for independent living is lost
1. Training of basic functional systems (physical, muscular training, get accustomed to low temperatures, adaptation to hypoxia) 2. Changing the function of regulatory systems, autogenic training, hypnosis, verbal persuasion; reflexotherapy 3. Non-specific therapy, balneotherapy, autohemoterapy, pharmacological means, adaptogens — ginseng, eleutero-cock and others, phytontcides, interferon, proteinoterapy, non-specific vaccination	1. Anesthesia 2. Hypothermia 3. Hibernation

LESSON 4. THE ROLE OF HEREDITY FOR PATHOLOGY

SITUATIONAL TASKS

№ 1

What is the probability of a child birth with syndactylism (accreted fingers) in the family, where the father has this developmental defect, while the mother and the first child have a normal structure of fingers?

Character	Gene	Genotype

№ 2

Determine the birth probability of short-fingered children in the family where parents have a developmental defect and are heterozygotes.

Character	Gene	Genotype

№ 3

In the family, where both spouses suffer from achondroplasia, a normal child was born. What is the birth probability of healthy children?

Character	Gene	Genotype

№ 4

Determine the birth probability of children with otosclerosis in the family, in which parents are heterozygous by the analyzed character (penetrance of 30 %).

Character	Gene	Genotype

№ 5

Determine the birth probability of children with astigmatism in the family, where father is heterozygous and mother does not suffer astigmatism.

Character	Gene	Genotype

№ 6

Homozygous individuals by a gene of crescent-cellularity usually die before puberty, heterozygotes are viable, anemia is revealed in hypoxia. What is the birth probability of phenotypically and genotypically healthy children, if both parents are heterozygous by the analyzed character?

Character	Gene	Genotype

№ 7

In genetic consultation a woman informed the doctor, that her sister was ill with a severe form of a crescent — cellular anemia, she herself had never been ill with anything, her husband is healthy. The woman wonders, whether a danger of getting this disease for her children is great? To answer this question a biochemical test of hemoglobin types was carried out; it revealed that the woman's blood contains: HbA — 70 % and HbS — 28 %; and her spouse's blood: HbA — 98 % and HbS — 0 %.

Character	Gene	Genotype

№ 8

What is the birth probability of sick children in the family where one of the parents is heterozygous by a gene of phenylketonuria, and another is healthy (his parents, brothers and sisters were healthy)?

Character	Gene	Genotype

№ 9

In genetic consultation pregnant woman C. informed, that her sister was ill with phenylketonuria, but she herself didn't suffer from this pathology. C.'s husband was healthy. There were kindred marriages between close relatives in her husband's family, but none of them was ill with phenylketonuria. Is there any danger for her child to get this disease? What is a probability of it? What is the role of sex? Is it possible to treat such a disease? Make up possible genealogical trees and answer the above questions.

Character	Gene	Genotype

№ 10

Successes of modern medicine allow to prevent the development of galactosemia and to avoid consequences of metabolic impairments. What is the birth probability of sick children in the family where one of the spouses is homozygous by a gene of galactosemia, but the development of his disease is prevented by diet, and the other is heterozygous on a galactosemia gene?

Character	Gene	Genotype

№ 11

What descendants can be expected from heterozygous parents on a gene of alcaptonuria?

Character	Gene	Genotype

№ 12

Determine the birth probability of sick children with hepatocerebral dystrophy (Wilson's illness) in the family where the father is sick, and the mother is healthy (her parents, brothers and sisters were healthy).

Character	Gene	Genotype

№ 13

In the family, where one of the spouses is an albino and the other is normal, binocular twins were born, one of which is normal concerning the analyzed character, and the other is an albino. What is the birth probability for the following child to be an albino?

Character	Gene	Genotype

№ 14

Healthy woman H., whose father was ill with daltonism, and mother was healthy, referred to genetic consultation with a question, whether there is any danger for her children to get this disease. The spouse of this woman is healthy. What could you answer this woman? Make possible family trees.

Character	Gene	Genotype

№ 15

The man, ill with hemophilia A, married a healthy woman whose father suffered from hemophilia A. Determine the birth probability of healthy children in this family?

Character	Gene	Genotype

№ 16

Healthy woman H., whose father is ill with hemophilia A and mother is healthy, referred to genetic consultation with a question: whether a danger for her grandsons to get this disease is great? Spouse H. and their three children — a son and two daughters — are healthy. What is the type of inheritance and what is the development of hemophilia A caused by? Is the development of a lethal form of the given pathology possible? What is the probability for her grandsons to get this disease on her son's line?

Character	Gene	Genotype

№ 17

A man, sick with hemophilia B, married to a healthy woman (in whose family nobody was ill with hemophilia), referred to the doctor with a question: what is the probability of their children to get this disease?

Character	Gene	Genotype

№ 18

In the family where the parents have hypoplasia of dental enamel, a son was born with normal teeth. What is the birth probability of sons with normal teeth?

Character	Gene	Genotype

№ 19

What is the birth probability of children with the absence of lateral incisors if the parents have this dental abnormality and they are heterozygous by the analyzed character?

Character	Gene	Genotype

№ 20

How many bodies of sex chromatin are there in people with genotype OX? XXY? XXX? XXXY? What is the sex of these people and what are they ill with?

№ 21

The karyotype of the given patient is characterized by the presence of 3 sex chromosomes. It is associated with a large stature, eunuch-like constitution, spermatogenesis impairment, microorchia, psychic impairment. What is the name of the given syndrome? What is the karyotype of the given syndrome?

№ 22

In patient M., height of 153 cm, is a skin fold on the neck, «sphinx» neck, primary amenorrhea, sterility. There are congenital defects of the heart and kidneys. What is the name of the given syndrome? What is the karyotype of the given syndrome?

ADDITIONAL INFORMATION

DESCRIPTION OF SLIDES

A. Trisomies-chromosomal syndromes

1. XYY-syndrome (on the left), the XXX-syndrome (on the right); (a superman and a superwoman).

XYY — impulsive aggressive behavior, a great number of such individuals are in prisons.

XXX — asthenia, IQ decrease by approximately 30 %.

2. Down's syndrome: a flat face, mongoloid shape of eyes, epicanthus, displastic auricles, hypotension, hypermobility of joints, dwarfism, mental retardation, simian fold, a big grasping finger on the foot. 95 % — trisomy of chromosome 21, 3 % — translocation. Incidence rate: 1 per 650 newborns; 5 % of all mentally retarded children have Down's syndrome. It is diagnosed prenatally (amniocentesis, ultrasound).

3. Down's syndrome (continuation): Brushfield's ring on the iris, furrows on the tongue.

4. Patau syndrome (trisomy of chromosome 13): confluence of frontal lobes of the brain. Bilateral cleft of the lip and palate, microcephaly, hypotelorism (decrease of the distance between the eyes), bicorn uterus, polydactylism, cystic kidney, coloboma of the iris, flexor contracture.

4a — continuation (a bicorn uterus, characteristic position of fingers on the hands and feet), cystic kidney, hypersegmentated neutrophile nuclei.

5. Trisomy 8: micrognathia, hypospadias, cryptorchidism, a cleft of the soft palate, hydronephrosis, absence of a knee cup.

6. Edwards's syndrome (trisomy of chromosome 18): micrognathia, hypoplasia of nails, shortening of a great toe on the feet, a horse-shoe kidney, dorsoflexor position of a great toe on the feet, hypertelorism, epicanthus, ptosis.

Monosomies

7. Turner's (XO) syndrome: absence of Barr bodies, flaccid skin (*cutis laxa*), hypoplasia of the uterus, cord ovaries, wing-shaped fold on the neck.

Deletions

8. Syndrome of Wolf-Hirshorn — $4p^-$: a prominent forehead, strabismus, preauricular shields, flat nose, short filter, «capr's mouth», hypoplastic mandible, colomaba of the iris, hypospadias, cryptorchidism, palatal cleft, deafness.

9. Syndrome of cat's shout — $5p^-$: anti-mongoloid shape of eyes, moon-like face, microcephaly, hypertelorism, epicanthus, low-positioned auricles, preauricular shields, flaccid laryngeal flap, specific arrangement of vocal chords, phonation impairment.

Congenital developmental defects of a multifactorial nature

10. Occipital cerebral hernia of meningocele (on the left). Monoamniotic twins (on the right) discordant by anencephaly (a proof of a non-genetic nature). Both conditions can be diagnosed prenatally (ultrasound, X-ray, alpha-fetoprotein level in amniotic liquid).

11. Typical anencephaly.

12. Hydrocephaly. Etiology is multifactorial. There are X-linked forms, recessive.

13. Syndrome of amniotic strands. Defects and amputation of extremities parts, associated with amniotic hauling. Hereditary forms are rare.

14. Swelling of the abdomen in Hirshprung disease (Agenesis of ganglia on certain sites of the intestines). An example of multifactorial disease.

Diseases with a dominant type of inheritance

15. Example of a dominant disease with complete penetrance (achondroplasia in the mother and the daughter, the father is healthy).

16. Congenital universal hypertrichosis. It is inherited in autosomal-dominant way. The disease has high penetrance and various expressivity.

17. Cylindermatosis. An example of an autosomal-dominant disease with incomplete penetrance.

Diseases with a recessive type of inheritance

18. Hemarthroses in hemophilia A in the area of knee joints and feet. The disease is due to deficiency of factor VIII, type of inheritance — X-linked, recessive.

19. Hunter's syndrome: X-linked recessive type of mucopolysaccharidosis. Mental retardation, rough face features (gargairism), hypertelorism, macroglossia, tight mobility of joints, hepatosplenomegally. Defect of glycosaminoglycans exchange. There are methods of prenatal diagnostics (biochemical).

20. Progeria (a syndrome of presenilation). It is inherited autosomally-recessively.

21. Lethal forms of osteochondrodysplasias: achondrogenesis, campomyelic syndrome («campos» — a sabre) — autosomal-recessive (?). Thanatophotic dysplasia (2 cases, autosomal-dominant type-?).

Pathologic forms with various types of inheritance

22. Ehlers-Danlos syndrome. Is due to a hereditary defect of the collagen structure. Is characterized by hyperelasticity of the skin, hypermobility of joints, rugosity of the skin, «sagging ears», scars on «tissue paper» type, hemorrhages (fragile vascular wall), heart defects.

There are methods of prenatal diagnostics (molecular-genetic).

Diseases with an unknown type of inheritance

23. An example of the disease with an unknown type of inheritance: neurodermal melanosis (nevuses).

24. Dysostosis — developmental defects of skeletal bones, underlying family hereditary diseases of the bone system.

(For the faculty of dentistry)

ISOLATED DEVELOPMENTAL DEFECTS, SYNDROMES AND HEREDITARY DISEASES

1. Isolated defect — bilateral microstomy (mouth up to ears) «a person who is smiling». Teratogenesis.

2. Oligodontia. It is inherited autosomally-predominantly.

3. Bilateral cleft of the lip, cleft of the maxilla and the palate. It is sometimes combined with defects of internal organs. Dysplastic auricles.

4. Fibromatosis of the gums, hypertrichosis, epilepsy and mental retardation. Autosomal-dominant type of inheritance. Long eyelashes, hair (a truncated syndrome).

5. Hypertrichosis-fibromatosis of the gums. It is inherited autosomally-predominantly, has autosomal-recessive forms. A full or truncated syndrome can develop.

6. Frontal-nasal dysplasia (an example of a sporadically occurred complex of developmental defects). Hypertelorism, a tip nose cleft.

7. Orofaciodigital syndrome (an example of an upper lip cleft, as one of the symptoms of the given syndrome). Other symptoms: a cleft of the soft and hard palate, shortened fingers and syndactylism. Is inherited X-linked. Homozygous boys, probably die intrauterine.

8. Riger's syndrome (peg-like teeth, irregular arrangement in the dentition, oligodontia, glaucoma, turbidity of the cornea, mental retardation). It is inherited autosomally-predominantly.

9. Plural mucous neuromas of the tongue and lips. Marfanoid type of constitution, tumors of the hypophysis, thyroid gland. It is inherited autosomally-predominantly.

10. Lesch-Hyhan syndrome. It is inherited X-linked, recessively. Is due to insufficiency of one of the enzymes — hypoxanthine-guaninphosphoribosyltransferase (HGPRT). Excess of purines in the organism causes choreoathetosis and self-aggression, the traces of which are visible on the face.

11. Erythropoietic porphyria (red pigmentation of teeth — «erythrodon-tia»). Other characters: splenomegally, hemolytic anemia, hypertrichosis, red urine). It is inherited autosomally-recessively.

12. Parodontosis in agranulocytosis of Costman. It is inherited autosomally-recessively. Due to neutropenia the infections of the oral cavity develop accompanied by the appearance of plural abscesses and injury of the parodontium.

Inheriotance type	Pathology form
1. Autosomal-dominant (A-D)	Polydactylism Brachydactylism Dactylion Curvature of fingers, nails Anonychia (underdevelopment of nails) Absence of lateral incisors Short-sightedness Far-sightedness Astigmatism Otosclerosis Achondroplasia Family hypercholesteremia Chorea of Huntington Polyposes of the large intestine Neurofibromatosis
2. Autosomal-recessive (A-R)	Crescent-cellular anemia (by incomplete domination) Galactosemia Phenylketonuria Alcaptonuria Albinism Glycogenoses Mucoviscidosis Wilson-Konovalov disease (hepato-cerebral dystrophy) Adrenogenital syndrome Congenital deaf-muteness Microcephaly
3. Dominant X-linked (D-X)	Frontal-nasal dysplasia Hypoplasia of dental enamel Cataract Rickets, resistant to vitamin D
4. Recessive X-linked (R-X)	Hemophilia A and B Daltonism Hypogammaglobulinemia Duchenne's muscular dystrophy Hemeralopia
5. Hollandric Y-linked (H-Y)	Excessive hairiness of auricles Azospermia
6. Mitochondrial (M)	Leber's optic atrophy Mitochondrial encephalopathy Myoclonal epilepsy Cardiomyopathy

Autosomal-dominant type of inheritance

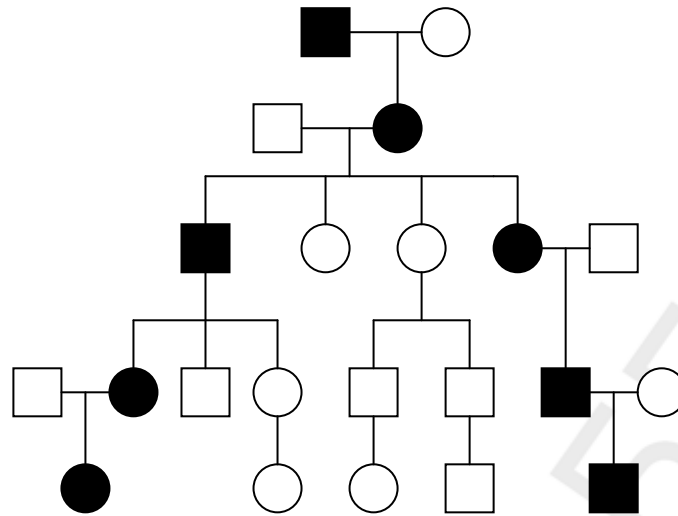

Inheritance characters on A-D type:

1. Identical pathology incidence both in males and females.
2. The presence of sick persons in every generation (vertical distribution character of the disease болезни).
3. Birth probability of a sick child is 50 % (irrespectively of the child's sex and the number of deliveries).
4. Healthy members of the family have as a rule healthy descendant.

Autosomal-recessive type of inheritance

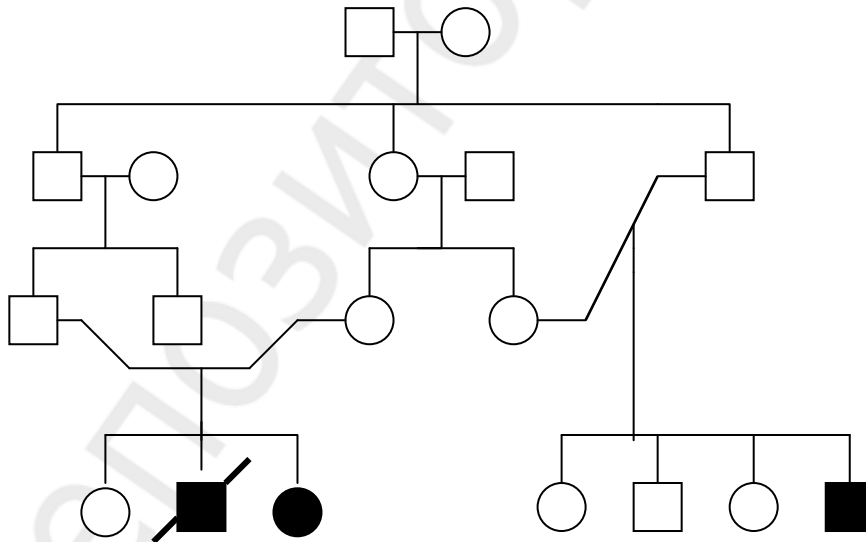

Inheritance characters on A-R type:

1. Identical pathology incidence both in males and females.
2. Manifestation of pathology in the genealogical tree along the horizontal line, often in siblings.
3. The patient's parents are healthy as a rule.
4. The disease may be revealed in other relatives, for example, y cousins and second cousins of the patient.

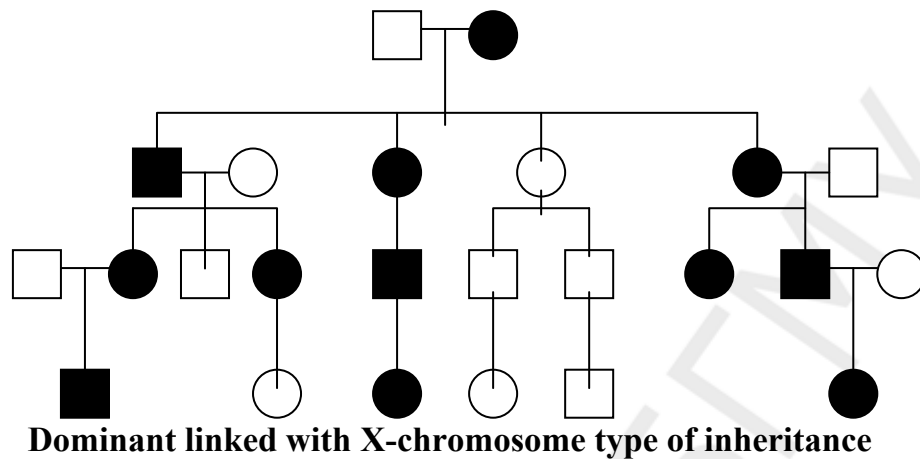

Inheritance characters on D-X type:

1. Fall ill both males and females, but females twice as often.
2. The disease is transmitted from a sick man to all daughters, but not sons (sons get an Y-chromosome from the father).
3. The disease is transmitted from a sick woman both to sons and daughters with an equal probability.
4. A more severe course of the disease is observed in males than in females.

Recessive linked with X-chromosome type of inheritance

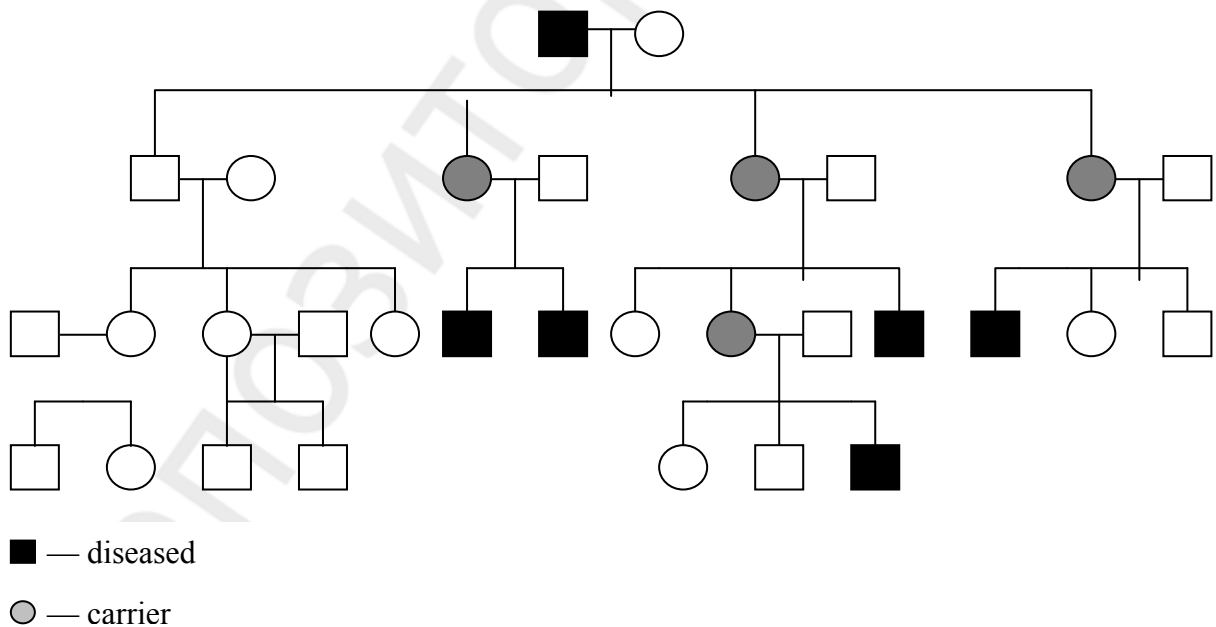

Inheritance characters on R-X type:

1. Sick children are born in phenotypically healthy parents.
2. The disease is observed mainly in males (mothers of patients are obligate carriers of a pathologic gene).
3. A son never inherits his father's disease.

4. A carrier of a mutation gene has the birth probability of a sick child of 25 % (irrespectively of sex of the neonate), the birth probability of a sick boy is equal to 50 %.

Various classifications of constitutional types

Authors	Year	Constitutional types (somatic types, types of the person)		
I. P. Paul		Physical	Athletic	Apopleptic
K. Sigo	1900	Respiratory Cerebral	Muscular	Digestive
H. Eppinger, L. Gess	1910	Vagotonic	Amphotonic	Symptomatic
K. G. Jung	1921	Introverted	Extraverted	
E. Krechmer	1921	Asthenic = leptosomal (schisoid)	Athletic (epileptoid)	Peaknic (cycloid)
M. V. Chernorutsky	1925	Hyposthenic	Normosthenic	Hypersthenic
A. A. Bogomolets	1926	Asthenic	Fibrous	Pastose Lipomatous
U. H. Sheldon	1940	Ectomorphpus	Mesomorphous	Endomorphous
Hippocrates – I. P. Paul	4 century up to AD — 1925	The sanguine person (strong counterbalanced mobile), the phlegmatic person (strong counterbalanced inert), the choleric person (strong unbalanced), the melancholic (weak)		
A. Labori	1970	Aerobic (sensitive to hypoxia)	Metabolically balanced	Pentous-glycolytically (steady to hypoxia)

Features of constitutional types according to U. H. Sheldon

Feature	Type	
	ectomorphous	endomorphous
Constitution	Dolichomorphia	Brachymorphia
Manual patterns	Simple (arches)	Complex(Difficult) (loops, curls)
Hypodermic veins of extremities	Net-like type	Stream-like type
Muscles	Red fibres (endurance)	White fibers (strength)
Power exchange	Aerobic	Anaerobic
Plastic exchange	Prevalence of katabolism	Prevalence of anabolism
Thyroid gland	The tendency to hyperfunction	The tendency to hypofunction
Adrenal glands, gonades	The tendency to hypofunction	The tendency to hyperfunction
Depth of respiration, Vital capacity	more	less
Arterial pressure	Below	Above
Blood glucose	Below, changes faster during the tolerance test	Above, changes slower during the tolerance test
Total protein, amino acids, uric acid	Below	Above
Cholesterol, triglycerides	Below	Above
Bilirubin	Above	Below
Ca 2 +	Below	Above
ABS (acid-base state)	Predisposition to alkalosis	Predisposition to acidosis
Groups of blood	I (O), II (A)	III (B), IV (AB)
Psychological functions	Introverts	Extroverts
Persistence to stress	Low	High

PRINCIPLES OF FIGHTING AGAINST MUTATIONS

Technological — Creation of wasteless productions.

Componental — Excluding the production of substances which can be mutagens (pesticides, medicines, etc.).

Compensatory — Increasing the resistance of the genetic system to environmental factors (using anti-mutagens).

LESSON 5. TOPICAL PROBLEMS OF GENERAL NOSOLOGY

SITUATIONAL TASKS

№ 1

Specify (typical) pathological processes developing in:

- acute pneumonia;
- myocardial infarction;
- crescent-cellular anemia.

Draw the conclusion about participation of typical pathological processes in the development of the disease.

№ 2

Specify compensatory reactions developing in:

- acute posthemorrhagic anemia;
- acute bronchitis;
- removal of one kidney;
- removal of one or several teeth;
- metabolic acidosis;
- acute hypotension;
- exogenous deficiency of iodine.

№ 3

Give the pathogenetic characteristic of a biological expediency and the role of the following compensatory reactions during recovery or progressing of the disease:

- vomiting and diarrhea in acute food poisoning;
- neutrophile leukocytosis in quinsy;
- reflex increase of the muscular tone in radiculitis;
- development of collateral portocaval blood circulation in liver cirrhosis with portal hypertension;
- reticulocytosis in anemias;
- reflex hyperactivation of sympatoadrenal and reninne-angio-tensin-aldosteron systems in cardiac insufficiency;
- hypersecretion of glucocorticoids, caused by hypoglycemia in progressing of malignant neoplasms;
- breathlessness while climbing mountains;
- vasoconstriction and centralization of blood circulation in traumatic shock;
- erythrocytosis in respiratory insufficiency.

Make the conclusion regarding a relative expediency of compensatory reactions in the development of the disease.

№ 4

Patient H., 42 years, referred with complaints of constant weakness, frequent dizziness, early fatigue, memory impairments, frequent colds, relapsing pustular skin lesions, impairment of swallowing, incidental irretention of urine while sneezing, breathlessness in insignificant physical exercise, sensation of discomfort behind the breastbone. From the case history: for the last 4 years the patient has been suffering from profuse dysfunctional uterine bleedings. The treatment with iron preparations hasn't produced a permanent effect.

Objectively: integuments are pale, lingual papillae are smoothed, the back of the tongue has chalk-like spots; bilateral angular cheilitis. The skin of the hands is dry, nails — of a spoon-like form.

Blood test: erythrocytes — $3,76 \times 10^{12}/l$; Hb — 72 g/l; CF (color factor) = ?; reticulocytes — 4,8 %; leukocytes — $3,6 \times 10^9/l$; thrombocytes — $142 \times 10^9/l$.

BP — 105/70 mm Hg, respiration is vesicular, 24 resp. per minute.

ECG: HR — 94 per minute, sinus rhythm, dystrophic changes in the myocardium of both ventricles.

What pathology has developed in patient H.?

1. List the manifestations of pathological reactions, characteristic of the given disease, explain their origin.
2. List the compensatory reactions; explain the mechanisms of their triggering.

№ 5

Patient G., 64 years, has been suffering from arterial hypertension for a long time, referred for treatment irregularly. Lately he started to note, alongside with constantly elevated blood pressure, more frequent attacks of breastbone pains, breathlessness on insignificant physical overstrain, periodically arising edemas on lower extremities.

Objectively: the patient of increased nutrition, BP — 190/100 mm Hg.

ECG: HR 76 per minute, sinus rhythm, horizontal position of the electric axis, hypertrophy of the left ventricle and the left atrium, dystrophic changes in the myocardium of the left ventricle.

Echo-CG: signs of diffused cardiosclerosis.

1. Give the pathogenetic characteristic of the left ventricle hypertrophy in arterial hypertension.
2. Why is cardiosclerosis the cause of the left ventricle hypertrophy in arterial hypertension?

3. What law of developing adaptation and compensatory processes is illustrated by the development of cardiosclerosis of hypertrophied myocardium?

№ 6

The 2-nd year student I. referred with complaints of pustular skin lesions of the face. Independent treatment by cosmetic means was of no effect. The case history revealed that she was developing similar symptoms each time during examination sessions on the background of constant nervous overstrain.

Objectively: on the skin of the face — multiple infiltrates, abscesses, pigmented traces of former lesions.

The total and biochemical blood tests are in norm.

The patient was administered topical anti-inflammatory and antibacterial therapy, desensitizing preparations, vitamins. It was recommended to refer for further consultation to a psychoneurologist.

Analyze possible mechanisms of functional impairment of the local immunity system in emotional stress.

№ 7

It is known that sportsmen — Olympians on the peak of their sports form become very susceptible to respiratory and intestinal infections, the development of the disease being characterized by a rather severe course.

What is a possible explanation of the given phenomenon?

№ 8

Experimental studies of the traumatic shock pathogenesis revealed an increase of noradrenaline, glucocorticoids, adrenocorticotrophic hormone, enkephalines, gamma-aminobutyric, gamma-oxybutyric acids, prostoglandines E, corticoliberine in the blood and a number of departments of the central nervous system.

Which of the listed compounds provides a natural anti-stress protection of the organism on the background of a traumatic action?

№ 9

It is known, that during the well-known Leningrad flooding in 1924, the animals whose cabins had been flooded, developed neurosis due to a sharp overstrain of the brain cortex by an excitation process that caused a failure of higher nervous activity. Repeated water inflow, even in rather small amounts,

into the cabins of dogs, whose symptoms of neurosis had already completely disappeared, resulted in the relapse of this disease.

What general pathologic law (A. D. Speransky was the first to formulate it) follows from these observations?

№ 10

The photo of one and the same rat, who has suffered local tetanus induced by injection of a semi-lethal dose of tetanus toxin into its hind left paw:



a



b

a — after disappearance of all symptoms of the disease; *b* — after subcutaneous injection of phenol (causing general convulsions in intact rats) — extensor rigidity of the former «tetanus» paw

№ 11

Formulate the conclusion suggested by experimental results of V. M. Konstantinov and P. N. Veselkin (fig. *a* и *b*).

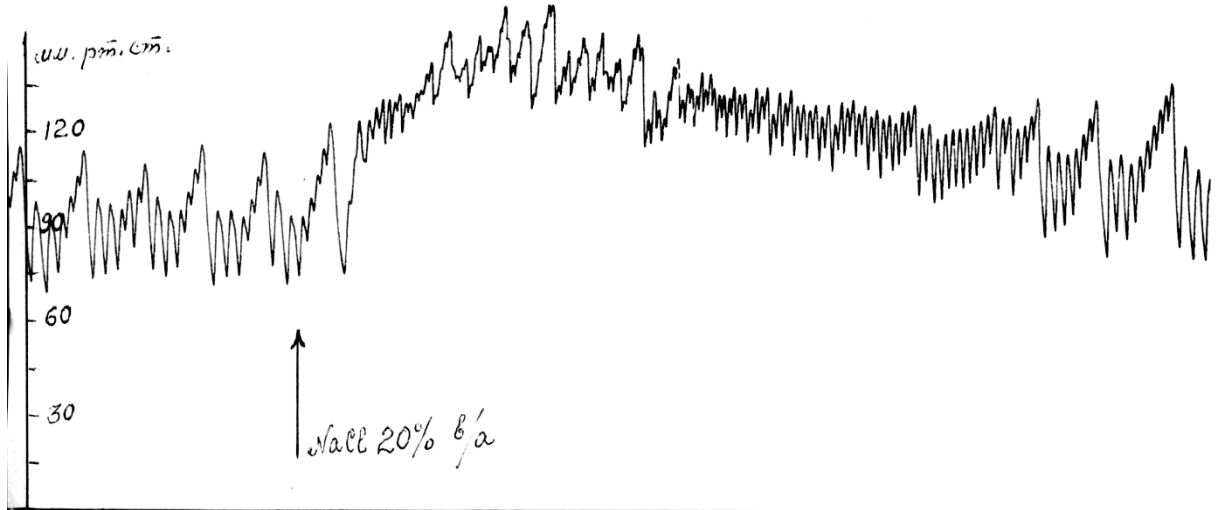
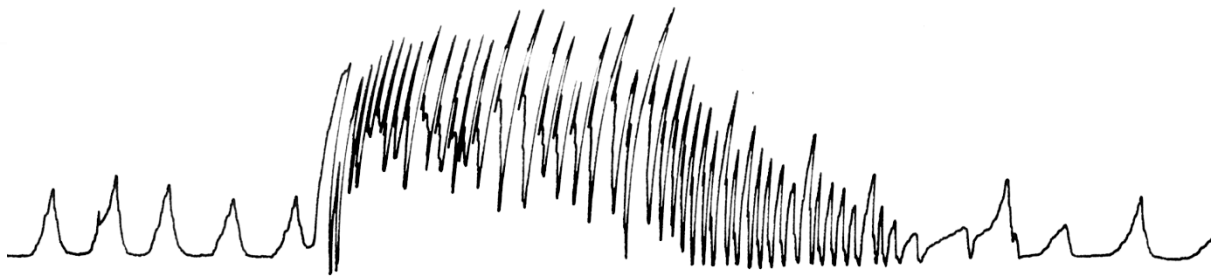

a

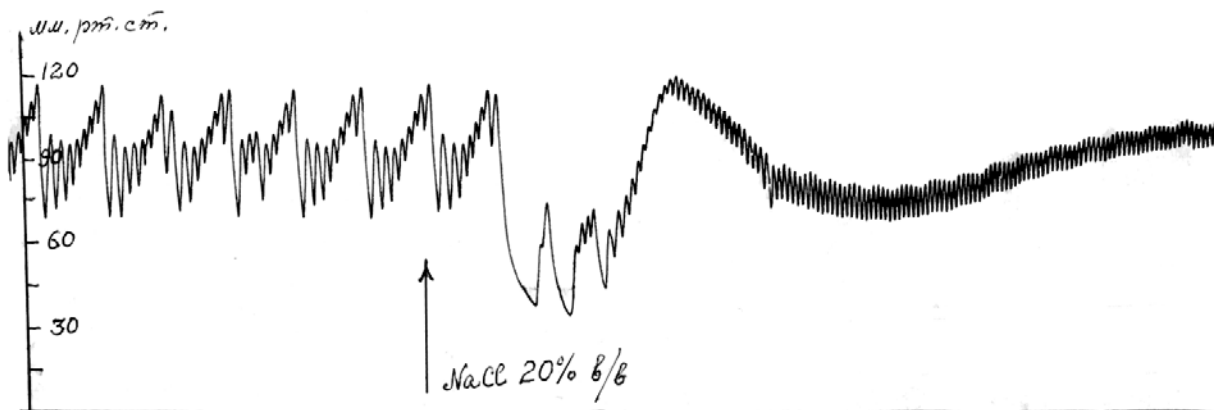
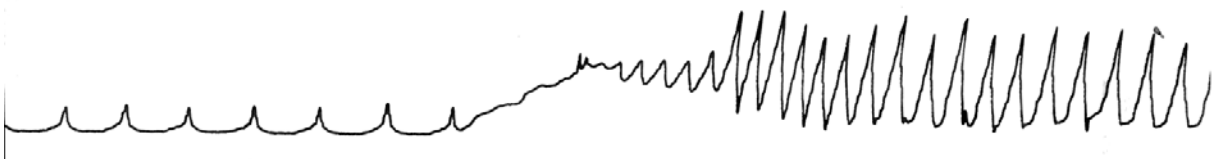

Respiration changes (the top curves) and arterial blood pressure (the bottom curves) on injection of 20 % NaCl into the femoral artery (*a*) and into the femoral vein (*b*).

№ 12

Portovenograms made on the 2-nd (*a*) and 20-th (*b*) day since portal hypertension started developing.

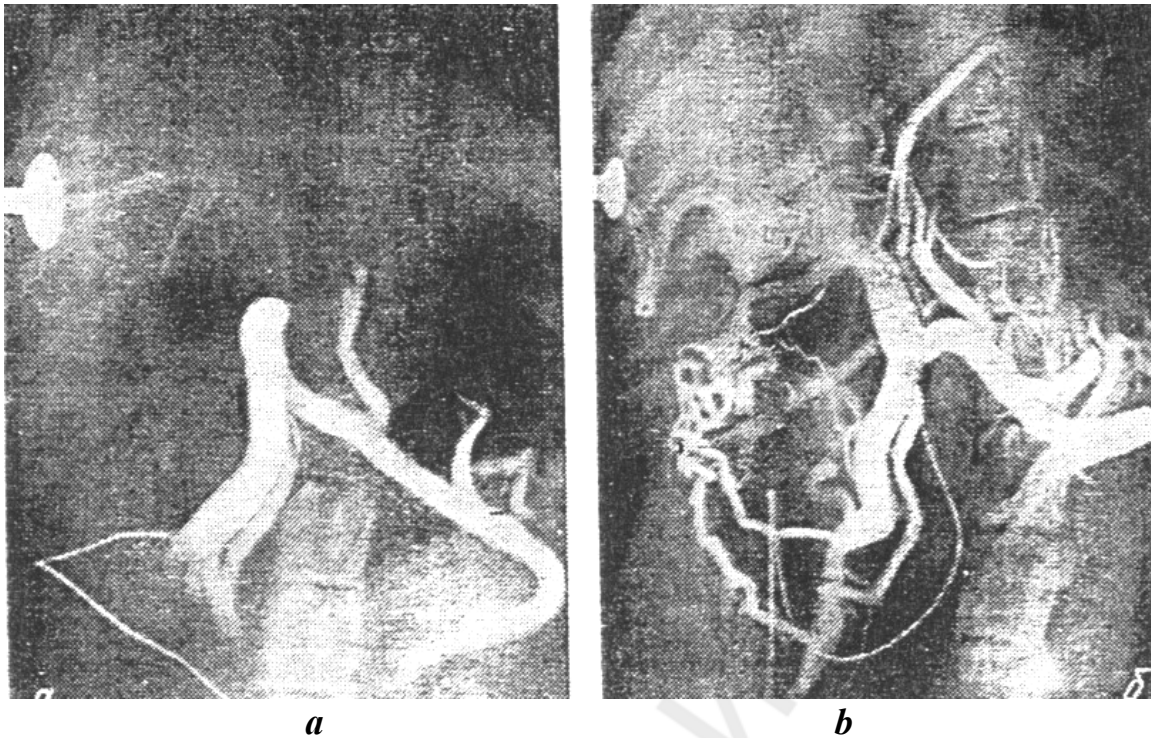

Comment on the information contained in X-ray pictures. Give the pathogenetic characteristic of the given phenomenon.

ADDITIONAL INFORMATION

«Disease is life of the organism in abnormal environment ... with deviations of only quantitative character».

R. Virhov, 1853

«Disease is adaptation of the organism characterized by specific forms and levels of adaptive activity».

I. V. Davydovsky, 1966

«Disease is life, the course of which is broken by damage of structures and functions of the organism under the effect of external and internal factors in reactive mobilization of its compensatory-adaptive mechanisms in qualitatively original forms and described by general or specific decrease of adaptability to the environment and freedom restriction of the patient's vital activity».

BME, 1976

«Disease is life of an injured organism with participation of processes compensating the impaired functions».

A. D. Ado, 1980

«Disease of a human ... is an inconsistent development process of damage and compensation (protection), not adequate to environmental conditions, decreasing the working capacity and capable to stop the existence of the organism as a whole».

A. D. Ado, 1985

«Disease is a dynamic condition of the organism characterized by the impairment of normal vital processes, resulting in a decrease of biological and social opportunities of the person ».

N.I.Losev, 1997

«Disease is the impairment of normal vital activity of the organism due to inherited genetic defect and/or the action of a damaging factor on the organism, characterized by the development of a natural dynamic complex of interconnected pathogenic and adaptive changes as well as the restriction of biological and social opportunities of the individual».

P. F. Litvitsky, 2002

«Disease is life with limited freedom».

K. Marx

**LESSON 6. PATHOGENIC EFFECT OF ENVIRONMENTAL FACTORS.
DAMAGING ACTION OF IONIZING RADIATION ON THE ORGANISM**

SITUATIONAL TASKS

№ 1

Patient P. had been having a direct contact with Radium salts within 11 years, working at a factory for Radium production and regeneration of its waste products. The total doze was composed of external γ -irradiation and inhaled radon. Then during 5 years her work was connected with chemical production. In 14 years since her first contacts with Radium compounds she developed symptoms of chronic rhino-laryngitis, tracheobronchitis and relapsing interstitial pneumonia with slowly formed pneumofibrosis. During the last year her general malaise, weakness, perspiration, breathlessness, palpitation became worse. She lost about 12 kg of weight. On examination: cervical, submaxillary and axillary nodes are palpated (have soft consistence, the size from a hazel-nut up to a hen's egg), the spleen and the liver are enlarged, furunculosis.

Blood test: Hb — 110 g/l, erythrocytes — $3,4 \times 10^{12}/l$; leukocytes — $102 \times 10^9/l$; basophils — 0 %, eosinophils — 0 %, young — 0 %, rod-nuclear — 1 %; segment-nuclear — 6 %, lymphocytes — 93 %, monocytes — 0 %, thrombocytes — $130 \times 10^9/l$. The bone marrow punctate contains a great amount of cells presented mainly by lymphoid elements of various maturity degrees.

Give grounded answers to the following questions:

1. What critical organs of patient P. appeared to be damaged?
2. In the form of what disease did the impairment of the hemopoietic tissue result?

№ 2

A group of children have found a capsule on the damp, it contained some powder luminous in darkness. Having broken the capsule, the boys rubbed its contents into various parts of the body, played «Indians», before going home they divided the powder between themselves by seniority. Kolya got the greatest amount, Vitya — a little bit less, etc. On the 7-th day blisters filled with yellow fluid started to form on Kolya's hands, forearms and face, on those places where the powder had been rubbed in and where several days ago red painful spots appeared; later (by the end of the 3-rd week) — ulcers began to form. The same sorts of changes occurred in Vitya and Sasha a little later and were developing more slowly. Only Vladik (the youngest) who only observed over his comrades and took hold of the capsule in his hands, had painful hyperemia of the hands. Laboratory investigation of the bottle contents established the nature of the powder. It was phosphor³².

Give answers to the following questions.

1. To what radiation does phosphor³² refer? What is the period of its half-decay?
2. How do we call the tissue damage that occurred in children?
3. What does the term of manifestation and various degrees of expressiveness of the described tissue damage depend on?
4. Is it possible to expect the development of acute radiation sickness in the children or does the occurrence of local damage exclude its development?

№ 3

Patient Z. 19 years, a laboratory assistant, was in the laboratory during an accident and for 30 min was exposed to the effect of a powerful source of γ -neutron radiation. The first symptoms developed already during the patient's presence in the room: enhancing weakness, nausea and then unrestrained vomiting. On the 3-rd–4-th day the condition of the patient improved, and she had no special complaints except of the loss of weight and aphthous stomatitis and pharyngitis (at the end of the 1-st week). Since the 14-th–15-th day her condition again worsened, the temperature started to elevate (up to 38–39 °C), on the 20-th day — numerous hemorrhages, ECG changes, pulse liability, arterial hypotension, vision deterioration appeared due to a developing cataract. Since the 31-st–34-th day her state of health began improving gradually. Growth of completely shed hair began since the 4-th month. Following-up the patient proceeded for 10 years. The dynamics of changing some blood parameters of patient Z. is presented in figure 1.

Having analyzed the available information, give a grounded conclusion about the disease that Z. has suffered.

№ 4

Patient I. applied to the doctor with complaints of severe general malaise, weakness, drowsiness, dizziness, frequent headaches, especially at night, bad appetite, profuse perspiration, irritability, memory failing, at times — pains in the heart area, fainting. On examination — instability of arterial pressure (alternation of normal BP with hypo-, less often with -hypertension), pulse liability.

Blood test: Hb — 90 g/l; erythrocytes — $3.0 \times 10^{12}/l$; CF — ?; leukocytes — $2.8 \times 10^9/l$; basophils — 0 %; eosinophils — 0 %; young — 0 %; rod-nuclear — 2 %; segment-nuclear — 58 %; lymphocytes — 37 %; monocytes — 3 %; thrombocytes — $100 \times 10^9/l$.

The anamnesis revealed that the patient has lived for 5 years already in one of the villages of the «alienation zone», where she returned despite the prohibition in 6 months after evacuation due to the accident at the Chernobyl nuclear power station. She eats vegetables grown in the kitchen garden, berries and

mushrooms collected in the nearest wood, milk from the cow, meat of rabbits she breeds. What pathology developed in patient I.?

№ 5

Boy Yu., 7 years, from Krasnopolje, Mogilev region, severely injured by the explosion at the Chernobyl nuclear power station, was admitted to the pediatric department for examination with complaints of pains in the throat on swallowing, elevation of temperature up to 38,5–39 °C, chills.

On admission: integuments and visible mucous membranes are pale. There are petechiae on the skin of the trunk, mucous membrane of the oral cavity and soft palate, necrotic coating on tonsils, gingivitis signs are marked. Cervical and subclavicular lymph nodes of about a string bean in size are palpated; they are not inoculated with surrounding tissues and cause no tenderness. No changes are revealed on the part of the heart and lungs.

The liver protrudes 2 cm from under the edge of the costal arch; it is dense and slightly tender on palpation. The spleen is not palpated.

Blood test: Hb — 78 g/l; erythrocytes — $2.5 \times 10^{12}/l$; CF — ?; leukocytes — $200 \times 10^9/l$; basophils — 0 %; eosinophils — 0 %; rod-nuclear — 0.5 %; segment-nuclear — 1 %; lymphocytes — 3 %; monocytes — 0 %; blast cells = 95.5 %; thrombocytes — $38 \times 10^9/l$; ESR — 60 mm per hour.

Cytochemical data: blast cells possess high myeloperoxidase activity, weak Schiff (PAS) reaction, moderately expressed activity of acid phosphatase and nonspecific esterase. What disease did the child develop?

№ 6

Figure 2 shows the dynamics of changes of a number of blood parameters of patient G., a liquidator of the Chernobyl accident. Having analyzed the presented information, give grounded answers to the following questions:

1. Had patient G. a radiation sickness? If yes, then what form of it?
2. Sign the names of corpuscular elements or parameters of total blood test over corresponding graphs.
3. What remote consequences can this patient have?

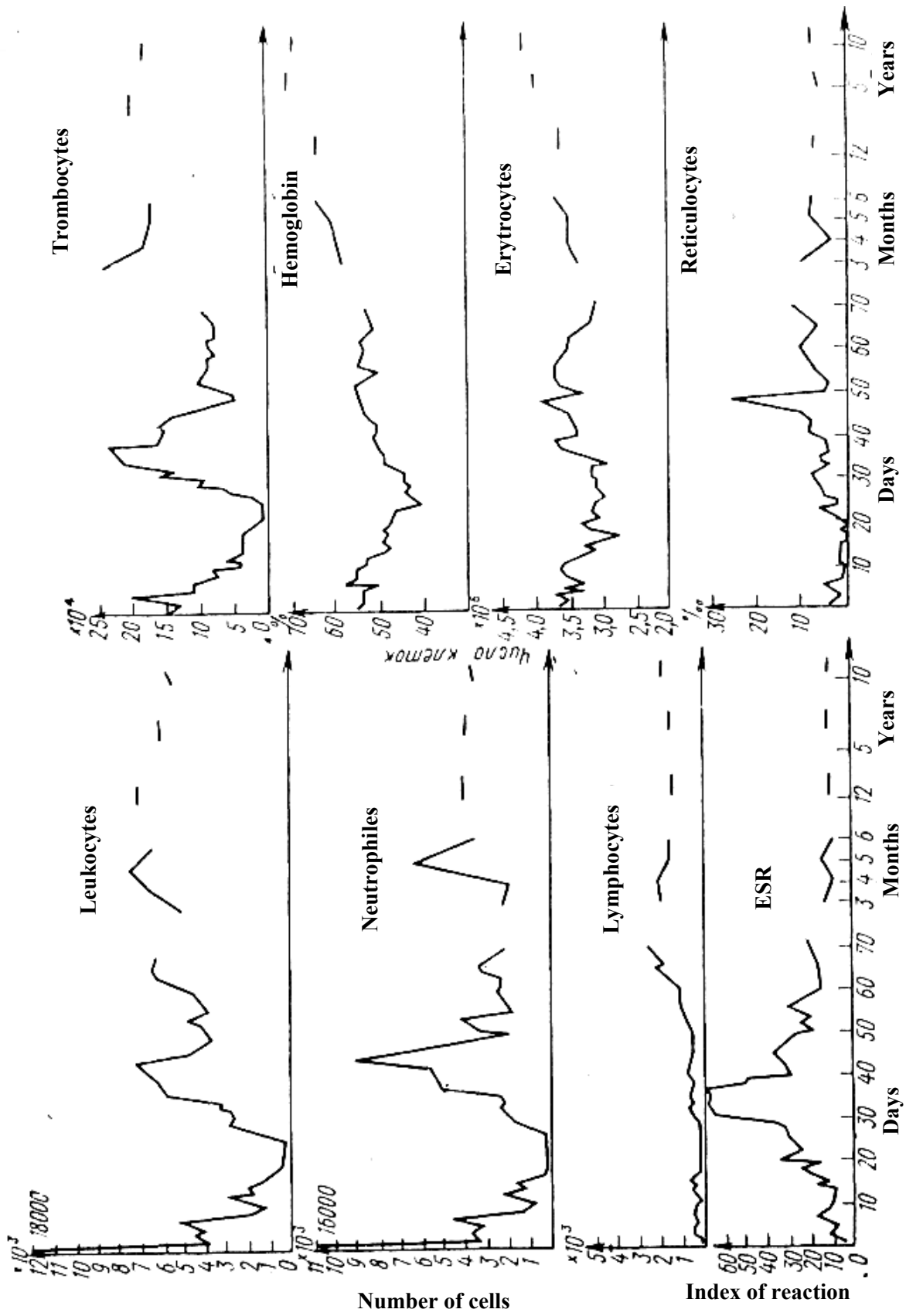

Fig. 1. Dynamics of changes of corpuscular elements count in patient Z.

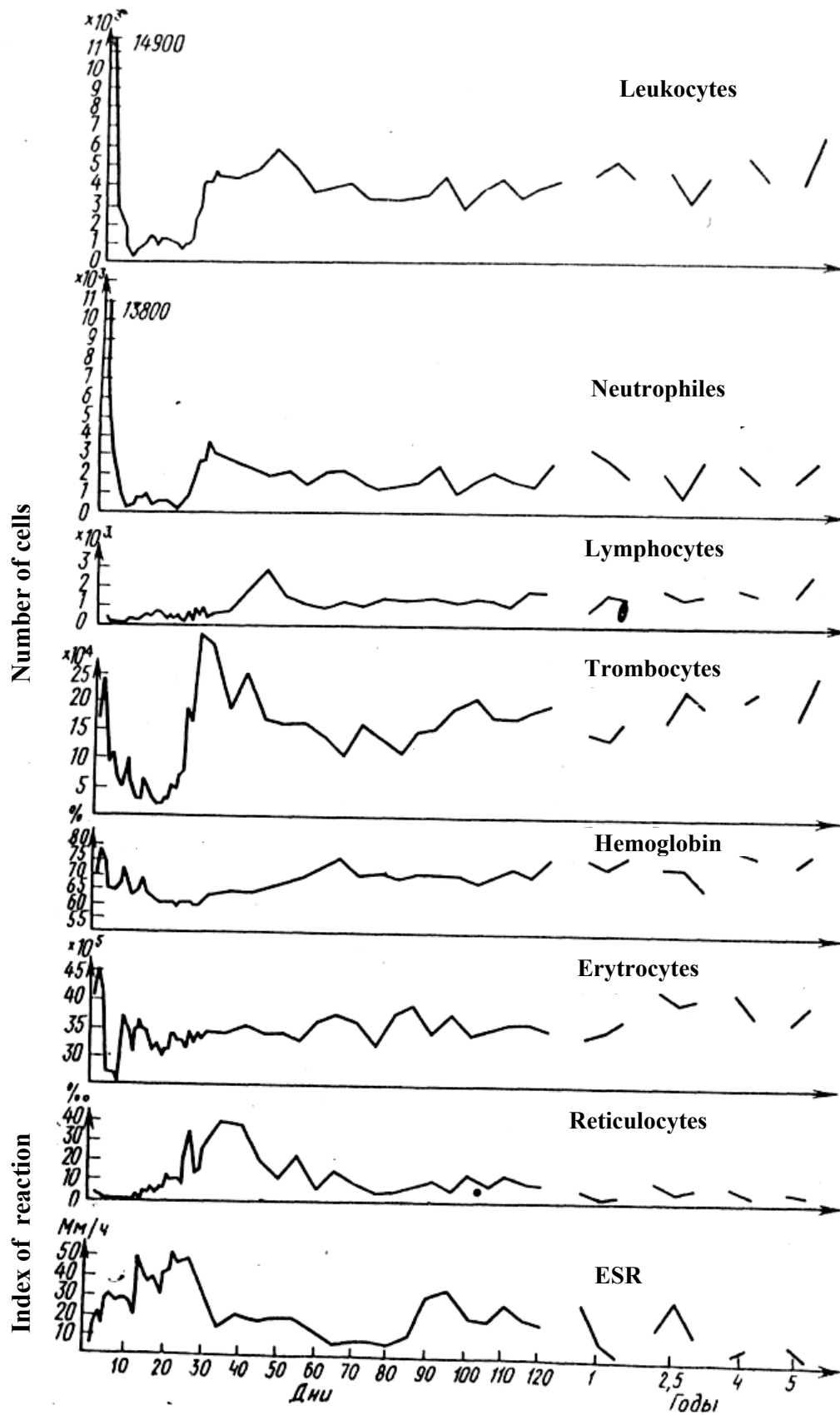

Fig. 2. Dynamics of changes of corpuscular elements count in patient G.

SECTION II TYPICAL PATHOLOGICAL PROCESSES

LESSON 1. TYPICAL IMPAIRMENTS OF PERIPHERAL BLOOD CIRCULATION. ARTERIAL AND VENOUS HYPEREMIA. ISCHEMIA. SITUATIONAL TASKS FOR INDEPENDENT WORK

№ 1

Is the sequence and character of functional, metabolic and structural changes in the area of venous congestion presented correctly? If not, then what is a mistake?

Difficulty of outflow of venous blood → slowing down of the blood flow velocity → pressure decrease in veins and capillaries → constriction of veins and capillaries → hypocapnia, hypoxemia → tissue oxygen starvation → impairment of tissue exchange: acidosis, decrease of vascular permeability, atrophic and dystrophic changes in tissues, growth reduction of connective tissue.

№ 2

Is the character of functional, metabolic and structural changes in the ischemized tissue presented correctly on the scheme given below? If not, then what is a mistake?

Restriction of inflow of arterial blood → oxygen starvation → decrease of the Krebs cycle efficiency → weakening of anaerobic glycolysis intensity → activation of energy exchange → biosynthesis enhancement of structural proteins → impairment of specific functions → necrobiotic changes in tissues.

№ 3

Patient A., 48 years, was made an abdominal puncture due to a heavy ascites. After evacuation of 7 l of fluid the patient's condition suddenly became worse: dizziness appeared, the patient fainted. Fainting of the patient was attributed to a manifestation of insufficient blood supply to the brain as a result of blood redistribution.

What form of impairment of regional blood circulation resulted from evacuation of ascitic liquid in the patient?

ADDITIONAL INFORMATION

Common signs of peripheral circulation impairment

Hyperemia		Ischemia
arterial	venous	
Increasing of blood filling of the organ or tissue due to excessive income of blood by arterial vessels	Increasing of blood filling of the organ or tissue caused by outflow difficulty	Restriction or complete cessation of the inflow of arterial blood — local anemia
<ol style="list-style-type: none"> 1. Increased pressure in arterioles, capillaries, venules 2. Dilation of small arteries, arterioles, capillaries and veins 3. Enlargement of visible by the eye vessels and functioning capillaries 4. Pulsation of fine arteries and capillaries 5. Generalized redness, increase of oxyhemoglobin content 6. Increasing of linear and voluminous velocity of blood flow 7. Local elevation of temperature 8. Volume enlargement of the organ or tissue 9. Tissue turgor increase 10. Increase of substance exchange and function of the organ 	<ol style="list-style-type: none"> 1. Pressure increase in capillaries and veins 2. Dilation of veins and capillaries 3. Enlargement of visible by the eye venous vessels, decrease of the number of functioning capillaries 4. Absence of pulsation 5. Hypercapnia, cyanosis due to $\uparrow\text{HbCO}_2$ и $\downarrow\text{HbO}_2$ 6. Slowing down of the blood flow up to stasis 7. Local decrease of temperature 8. Volume enlargement of the organ or tissue 9. Edema 10. Impairment of metabolism and function due to hypoxia, subsequent overgrowth of connective tissue (sclerosing) 	<ol style="list-style-type: none"> 1. Pressure decrease below the obstacle in arterioles, capillaries and venules 2. Diameter decrease of all vessels below the obstacle 3. Number decrease of visible by the eye vessels and functioning capillaries 4. Absence of pulsation 5. Paling of the ischemized area 6. Decrease of linear and voluminous velocity of the blood flow 7. Local decrease of temperature 8. Decrease of the organ volume 9. Decrease of turgor 10. Impairment of metabolism and sensitivity; numbness, pain, function impairment, dystrophy

LESSON 2. TYPICAL IMPAIRMENTS OF PERIPHERAL BLOOD CIRCULATION. THROMBOSIS. EMBOLISM. STASIS

Situational tasks

№ 1

In experimental modeling of thrombosis it is established, that in the area of blood circulation impairment below the site of thrombus formation the blood flow is slowed down, microvessels are constricted, intravascular pressure is decreased. The thrombosis of what vessel, arterial or venous, was produced in the experiment?

№ 2

Patient A., 52 years, was removed a femoral tumor. While dissecting tumor commissures the femoral artery was damaged. A vascular stitch was put on the site of the lesion, pulsation of the artery below the site of lesion after putting the stitch was good. A day after the operation severe pains in the operated extremity appeared. Pulse on the back side of the foot is not palpated, movement of fingers is absent. The skin got pale and cold.

1. What form of impairment of peripheral blood circulation is suggested by the developed symptoms in the patient?

2. What is a probable impairment cause of regional hemodynamics in this case?

№ 3

Patient A., 16 years, is delivered to the traumatological department for an open fracture of the left hip in the middle third with displacement of fragments. The operation was made under endotracheal anesthesia. At the moment of reposing the bony fragments bradycardia suddenly occurred, the pulse was 46 beats per minute, arterial pressure dropped up to 90/30 mm Hg. Marked hyperemia with cyanosis of the face integuments appeared. In 10 min the pulse on carotid arteries disappeared, the pupils dilated. Clinical death was stated.

What kind of impairment of peripheral blood circulation could cause the subsequent impairments of systemic hemodynamics in the patient?

№ 4

In the development of experimental fatty embolism in vessels of the pulmonary blood circulation there occurred a sharp decrease of BP in dogs and marked breathlessness. Death of experimental animals occurred within the first day. In what way will the condition of animals and their life expanse change, if experimental embolism is induced after preliminary cutting of their vagus nerves?

№ 5

In 15 min after decompression the diver, who had been working at the depth of 15 m, developed signs of the compressed-air disease: itching, pains in joints and muscles, dizziness, nausea, general weakness.

1. What is the origin of the developed embolism?

2. Of what gas do the vesicles consist in the given form of embolism?

Pathogenesis of pulmonary artery thromboembolism

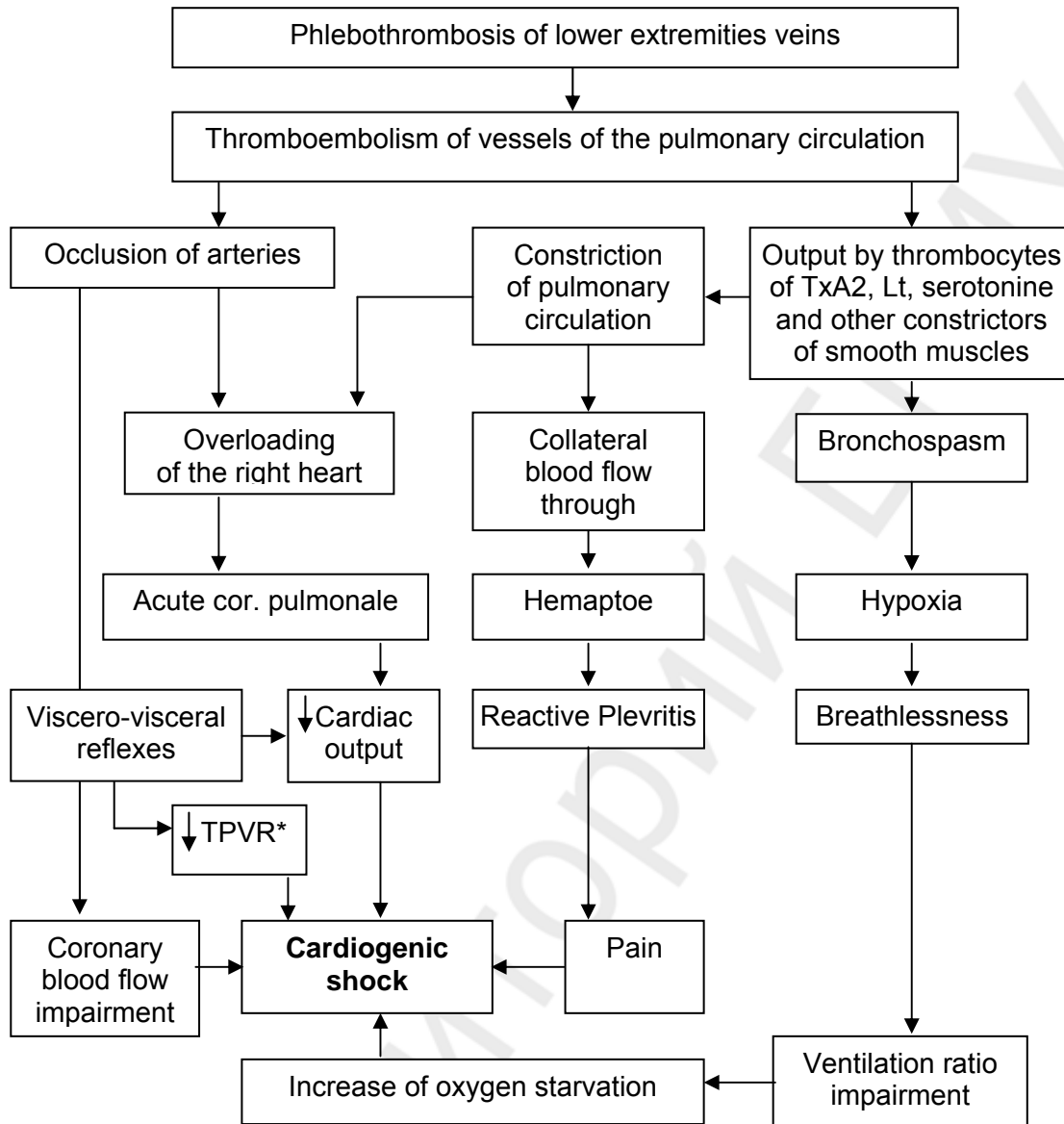

* TPVR — total peripheral vascular resistance

LESSON 3. TYPICAL IMPAIRMENTS OF PERIPHERAL BLOOD CIRCULATION. IMPAIRMENTS OF MICROCIRCULATION

SITUATIONAL TASKS

№ 1

Experimental modeling of thrombosis of MCR (microcirculatory) vessels in the dog revealed that the amount of hydrostatic pressure in the venous part of a capillary in the area of blood circulation impairment makes up 23 mm Hg,

the oncotic intravascular pressure is 25 mm Hg, the tissue oncotic pressure — 4 mm Hg. Are there any conditions for the development of tissue edema?

№ 2

When a drop of mustard oil is applied to the skin of a rabbit, a marked dilation of arterioles, capillaries and veins is marked. Meanwhile the taken hydrostatic blood pressure on the arterial end of a capillary is 34.5 mm Hg, on the venous end — 17.5 mm Hg, oncotic blood pressure — 25 mm Hg, tissue hydrostatic pressure — 3 mm Hg, tissue oncotic pressure — 4.5 mm Hg. Are there any conditions for the development of tissue edema?

ADDITIONAL INFORMATION (by Litvitskomu P.F., 2002)

Typical impairments of microcirculation

I — Intravascular:

- slowing down/ sharp acceleration of the blood (lymph) flow;
- lamination impairment of the blood flow due to aggregation of corpuscular elements and increase of plasma viscosity;
- shunting of the blood stream roundabout MCR capillaries.

II — Transmural:

- increase of vascular permeability;
- formation of extravasates.

III — Extravascular:

- increase of the interstitial fluid volume and decrease of its outflow velocity.

Capillarotropic insufficiency is the condition characterized by the impairment of blood- and lymph-circulation in vessels of the microcirculatory channel, transport impairment of fluids and corpuscular elements of blood through the walls of microvessels, slowing down of the outflow of interstitial fluid and metabolic impairments in tissues and organs.

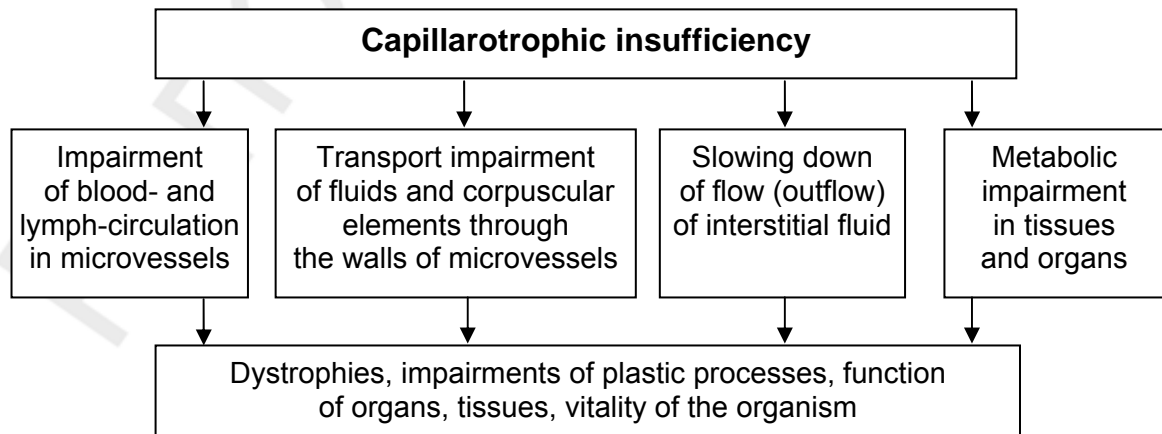

LESSON 4. DAMAGE OF THE CELL

SITUATIONAL TASKS

№ 1

Boy M., 8 years, with Hirschprung's disease and expressed intoxication underwent preoperative examination that revealed, in particular, that the lower border of osmotic resistance of erythrocytes (ORE) was 0.47 % of NaCl solution, free plasma hemoglobin — 0.38 g/l.

After operative intervention (imposing a colostoma) the condition of the patient considerably improved. The lower border of ORE comprised 0.36 % of NaCl solution, free hemoglobin in plasma was absent.

1. What do the ORE parameters and free hemoglobin content in plasma of patient M. before the operation testify to?
2. Estimate the condition of cellular membranes in Hirschprung's disease?
3. What can the changing of the condition of erythrocyte membranes of the patient before the operation be caused by?
4. What blood disease is also accompanied by a decrease of ORE and development of hemolysis? How can this pathology of patient M. be eliminated?

№ 2

Are the mechanisms and sequence of processes in the development of hypoxic cellular destruction in ischemia presented correctly?

Ischemia → increase of macroergos synthesis → activation of ionic pumps → entrance of potassium ions into the cell and exit of sodium, calcium and water from the cell, → endocellular alkalosis, dehydration + decrease in calcium concentration in the cell → activity inhibition of lipases, phospholipases and LP (lipid peroxidation) processes → damage of membranes and ferment systems → destruction of the cell

Your version:

№ 3

To create an experimental model of a sharp toxic hepatitis, rats were intragastrally given 50 % solution of CCl₄ in sunflower oil at the rate of 0.5 ml per 100 g of weight during 10 days. Meanwhile the changing of mitochondrial enzyme activity of the hepatic tissue of rats was observed. The activity of SUB-dependent malatdehydrogenase was reduced by 22.5 %, and SUB-dependent glutamatdehydrogenase — by 95 % in comparison with the control.

Explain the mechanism of observable changes of mitochondrial enzyme activity of the rats' liver in the development of toxic hepatitis.

№ 4

Patient X., 44 years, complains of sharp general weakness, the feeling of heaviness in the right hypochondrium, constant nausea, bleeding gums, drowsiness.

The anamnesis revealed that the patient had been abusing alcohol since 18 years. The specified complaints appeared about one year ago. By this time he was twice treated in clinic.

On examination: the condition of moderate severity, the patient of decreased nutrition and the skin is dry, icteric sclera and skin, «vascular asterisks» on the face and shoulder girdle. Edemas are not present. The tongue is coated. The abdomen is inflated, soft and painless on palpation. The liver protrudes 6 cm from under the edge of the costal arch; its edge is rounded, painful. The spleen is palpated 2 cm below the left costal arch. The biochemical blood test revealed the activity of serum aminotransferases: ALT-97 IU/l, 55 IU/l.

In 2 weeks after hospitalization and administration the patient a pathogenetic therapy including vitamins and hepatoprotectors, the condition of the patient improved, the activity of serum aminotransferases became: ALT-75 IU/l, AST-40 IU/l.

What caused the increase of serum aminotransferases activity in the patient's blood before the treatment and to what does such change of activity testify?

What disease is presumably present in this patient?

LESSON 5. INFLAMMATION. IMPAIRMENTS OF BLOOD CIRCULATION IN THE FOCUS OF INFLAMMATION. SITUATIONAL TASKS

№ 1

Two rabbits with preliminarily induced local inflammation by a thermal burn on one of the hind extremities got one and the same doze of strychnine. Besides, strychnine was injected to one rabbit into the inflammation area, to the other — outside the focus of inflammation. One of the rabbits died of poisoning with strychnine.

Specify, what rabbit died and why?

№ 2

If to inject the streptococcus culture into a knee joint of the rabbit in a definite titer, microbe cells can be revealed in blood and internal bodies in 24 h.

Will the velocity of microorganisms dissemination change, if:

- 1) an acute inflammation of a knee joint is induced before their injection?
- 2) they are injected simultaneously with the agent causing an inflammatory reaction?

№ 3

A great number of monocytes, lymphocytes and a slight amount of neutrophile leukocytes are revealed in exudate.

For what inflammation, acute or chronic, is the specified situation more typical?

№ 4

A high content of eosinophiles was revealed in exudate.

Of what type of inflammation, infectious, aseptic, immune-allergic, is the specified cellular structure of the exudate characteristic?

№ 5

Patient B., 39 years. Several days ago she revealed a dense painless formation in her left mammary gland that led her to the doctor.

Objectively: in the left external quadrant of the left mammary gland a dense formation without clear outlines, of a rounded shape, 3×4 cm in size is found out. The formation is of densely-elastic consistence, painless on palpation, not inosculated with the skin and subjected tissue. The skin over it is not changed. Regional lymph nodes are not palpated.

Are there any signs testifying to an inflammatory nature of the disease in the patient?

№ 6

Patient B., 27 years, a feeding mother. In 3 weeks after deliveries the pains in the area of her left breast appeared; feeding by this breast became painful. On the 3-rd day of the disease the patient felt chills, her body temperature elevated up to 39 °C, the pain in the affected gland became worse.

Objectively: in the affected gland a dense formation with unclear borders, 5×5 cm in size, very painful on palpation is revealed. The foci of softening, fluctuation are not present. There is marked reddening of the skin above the formation, dilation of subdermal venous vessels in the area of the gland, enlargement of regional lymphatic glands.

The laboratory examination revealed: the count of leukocytes in blood — $12.4 \times 10^9/l$; ESR — 35 mm /h.

Are there local and general signs testifying to an inflammatory nature of the disease in the woman?

№ 7

Patient B., 32 years, complains of aches in joints, their deformation, subfebrile temperature. The anamnesis reveals infectious polyarthritis since 27 years. The disease proceeds with frequent relapses.

The patient's examination revealed: the count of leukocyte — 12.6×10^3 per 1 microl; ESR — 26 mm/h. The total blood protein — 75 g/l. The albumin level is reduced (41 %), the fraction of alpha-globulins is increased (14.7 %). The diphenylamine test is positive. The reaction to C-reactive protein is positive.

Are there any signs in the patient testifying to exacerbation of the inflammatory process?

№ 8

Patient B., 12 years. The examination revealed an abdominal stasis. To find out the character of the accumulated liquid the paracentesis (a puncture of the abdominal cavity) was made.

On puncture a rather turbid punctuate of a light yellow color was received. The relative density — 1.029. The protein content 2–0.39 g/l. In the residue: a significant amount of corpuscular elements. Neutrophiles prevail, degenerative forms being in great number among them. The microbe flora is placed intra- and extracellularly.

What is the character of liquid received on puncturing?

№ 9

Patient B., 27 years. The examination revealed an abdominal stasis. To make precise the causes of developing ascites a puncture of the abdominal cavity is made.

In paracentesis a clear punctuate of a light yellow color is received. The relative density: 0.1014. The protein content — 0.2 g/l. Revalt's test — negative, lymphocytes prevail among corpuscular elements.

What is the character of liquid that was found in the patient?

№ 10

Patient C., 25 years, is delivered to the reception ward of the hospital with complaints of weakness, generalized pain in the abdomen, nausea, periodic vomiting. A sharp onset of the disease occurred two days ago, when he felt malaise, nausea, pain in the epigastric area. He didn't refer to the doctor, as suggested food poisoning. The next day the pains in the abdomen became worse and extended to the right iliac area, the general state notably aggravated, recurrent vomiting occurred. On examination of the patient: integuments are damp, the temperature — 38.5 °C, pulse of 105 beats/min, respiration rate — 25 per one minute. On palpation — the abdomen is tense, sharp tenderness in the right iliac area is marked, the signs of peritoneal irritation are not clearly marked. In the total blood test the count of leukocytes — $15.9 \times 10^9/l$. The leukocyte formula: eos. — 0 %; bas. — 0 %; young. — 4 %; rod. — 13 %; segm. — 63 %; lymph. — 12 %; mon. — 8 %. After examination the patient was urgently hospitalized to undergo emergency appendectomy. The vermiform process is phlegmonous, fused with surrounding tissues, the peritoneum is hyperemized, hemorrhagic exudate is found in the abdominal cavity.

1. Name the local and general signs of inflammation in the patient.
2. Characterize the changing of the total blood test parameters.
3. Give the pathophysiological characteristic of the severity degree of the patient's condition and prove the conclusion (see with. 35).

ADDITIONAL INFORMATION (on A. Sh. Zajchik, A. P. Churilov, 1999)

Basic endogenous anti-inflammatory factors

- Glucosaminoglycans: heparin, chondroitinsulphate. The main effect — normalization of permeability of histohematic barriers.
- Inhibitors of enzymes:
 - Anti-proteases*: α 1-antitripsin, α 2-macroglobulin, inhibitors of complementary systems.
 - Anti-phospholipases*: lipocortin, renocortin, etc.
- Inactivators of inflammation mediators: histaminase, arilsulphatase (destroys leukotriens).
- Antioxidants: ceruloplasmin, haptoglobin, superoxidedismutase, etc.
- Anti-inflammatory cytokines: IL-4, IL-10, IL-11, IL-13.
- Glucocorticoids — the most effective anti-inflammatory agents.

LESSON 6. INFLAMMATION. PHAGOCYtic REACTION IN INFLAMMATION

SITUATIONAL TASKS

№ 1

Life expectancy of mice after intraperitoneal (i/p) injection of 0.2 ml of the bacterial suspension containing 5×10^8 of pneumococci, is on an average 8 h. If the same amount of the bacterial suspension is injected into mice in 2 h after injection of 0.5 ml of a sterile solution of starch or ink, death occurs approximately in 3 h.

How can you explain the reduction of life expectancy of mice after injecting the bacterial suspension to the animals on the background of preliminary intraperitoneal injection of starch or ink?

№ 2

Vitya D., 3 years. Since the first year of life he has been suffering from frequent recurrent infections, flaccid fever with subfebrile temperature.

Blood test: erythrocytes — $3.4 \times 10^{12}/l$; leukocytes — $2.6 \times 10^9/l$, of them neutrophils — 29 %, lymphocytes — 61 %.

The immunologic examination revealed: serum concentration of antibodies G, M and A are in norm. Complement activity is within normal limits.

While performing a test for mobility of leukocytes («skin window» test) it was revealed, that already in 3 h mono-nuclear cells prevail over polymorpho-nuclear ones at the site of scarified skin («focus of inflammation»).

The injection of hydrocortisone to the child gave no increase of the leukocyte count in the blood.

A test with restoration of nitro-blue tetrasolium for bactericidal activity of leukocytes is normal.

Have there been obtained any data as a result of the child's examination testifying to phagocytosis pathology?

№ 3

Koctya D., 9 years. Constant persistent and recurrent infections have been observed since the first year of life presented as furuncles, purulent tonsillitis, otitis, abscessed pneumonias.

Total blood test: ESR — 32 mm/h, leukocytes — $15 \times 10^9/l$, of them neutrophils — 70 %, lymphocytes — 21 %.

The reaction for C-reactive protein is positive. The complement activity is within normal limits. The concentration of antibodies G, M and A in the blood serum is in norm. The lymphocyte reaction to phytohemagglutinine (nonspecific mitogen, causing transformation of blasts) and tuberculin is positive.

Phagocytosis of staphylococci, yeast particles is carried out in equal volume both by granulocytes of the patient, and by control granulocytes of a healthy donor. The test for intracellular digestion using staphylococci reveals a maximum amount of killing equal to 85 % in granulocytes of the control donor and 35 % in granulocytes of the patient.

Are there revealed any changes in the patient characteristic of humoral or cellular immune defects?

№ 4

Patient M., 7 years. The presence of giant peroxidase-positive granules in neutrophiles, eosinophiles, monocytes of peripheral blood and bone marrow is revealed. There are observed: uncompleted phagocytosis, recurrent purulent diseases, nystagmus and photophobia.

Questions:

1. Specify, with the pathology of what cellular organellas this impairment is associated.
2. Specify the cause and mechanisms of the given syndrome.
3. What is the name of the given syndrome?

LESSON 7. HYPOXIA

SITUATIONAL TASKS

№ 1

Two rats, one of which was under narcosis, were exposed to the action of rarefied air in the altitude chamber.

What rat will be the first to die?

Explain, why.

№ 2

According to experimental results the removal of a part or even the whole lung in healthy dogs, as a rule, was not accompanied by the impairment of blood oxygenation. At the same time discontinuation of ventilation within one lobe of the lung by obturating the corresponding bronchus resulted in saturation decrease of arterial blood by oxygen approximately by 5–6 %.

What is the cause of blood oxygenation decrease in obturation of a healthy lung lobe in contrast to pneumonectomy or lung resection?

№ 3

On examination of the patient the arterial-venous oxygen difference was noted to decrease from 4 to 2 vol. %.

To what kind of hypoxia can the obtained experimental results testify?

№ 4

The estimates of arterial-venous difference on oxygen in the patient revealed, that during the first examination it was 5 vol. %, and then increased up to 7 vol. %.

1. Do the received data suggest the development of a progressing tissue hypoxia?

2. How can the arterial-venous difference on O₂ be estimated?

№ 5

The geologist being a member of an expedition to a high-mountainous district arrived to perform research works. On the 2-nd day of staying at the altitude of 3000 m the symptoms characteristic of the mountain disease and manifesting the development of hypoxia appeared: headache, breathlessness, loss of appetite, general weakness, sleeplessness.

1. What are the causes and character of hypoxia developed in the participants of the expedition?

2. What are the factors that caused breathlessness in this case?

3. What severe complication of breathlessness can occur in a high-mountainous district?

№ 6

Patient K., 45 years, having a long history of gastric ulcer, was delivered to hospital with gastric bleeding. On admission he complained of increasing weakness, nausea, dizziness, noise in the ears, flashes in front of the eyes. The patient was pale. Expressed breathlessness was marked.

There is moderate tenderness in the epigastric area. The symptoms of peritoneum irritation are absent. BP — 100/70 mm Hg. Pulse — 95 beats/min.

1. List the symptoms of hypoxia developed in the patient.

2. What type of hypoxia developed in the patient?

3. What are the development mechanisms of breathlessness in this case?

№ 7

An operator of the aniline dyes production was delivered to the health center with a clinical picture of poisoning with aniline. Hypoxia symptoms prevailed: nausea, vomiting, headache, noise in the ears, flashes in front of the eyes, weakness and drowsiness. Cyanosis of mucous membranes, a bluish color of the face and skin integuments are marked.

On hemospectrophotometry an expressed methemoglobinemia is marked.

1. What pathogenetic factor underlies the development of hypoxia in this case?
2. To what type of hypoxia is it referred?
3. What changes of gas blood structure are characteristic of the given type of hypoxia?

**LESSON 8. TYPICAL IMPAIRMENTS OF METABOLISM.
IMPAIRMENTS OF WATER EXCHANGE. EDEMAS**

SITUATIONAL TASKS

№ 1

Patient Z., 13 years, referred with complaints of edema of the left half of the face, that had developed for 3 h on the day of the reference. According to the words of the parents the girl had eaten a lot of strawberries on the eve in the evening.

Objectively: the face is edematous, asymmetrical, the edema extends mostly to the left half of the face, lower and upper eyelid; the color of integuments is not changed.

On palpation: moderate tenderness, local fluctuation is absent. BP is 105/60 mm Hg, vesicular respiration in the lungs, the abdomen is soft, not tender on palpation, body temperature — 36.8 °C.

Questions:

1. Specify the type of edema. What are their development mechanisms?
2. What is a pathogenetic therapy of this edema?

№ 2

Patient H., 49 years, developed a diffused edema of the right arm in 2 weeks after radical right-side mastectomy. Objectively: on palpation — moderate tenderness, the color of integuments is slightly cyanotic. Local tissue consolidation and fluctuation are not determined.

What is the development mechanism of the edema?

№ 3

The in-patient of 42 years was diagnosed «myocardiodystrophy at the stage of decompensation». The patient was of normal constitution, hypodermic cellular tissue is poorly developed. For the height of 165 cm the body weight was 81 kg. Objectively: forced semi-sedentary position, breathlessness, acrocyanosis, marked pastosity of lower extremities, congestive râles in the lungs. Ascites in the abdomen is revealed, the liver is enlarged. Stroke and minute volumes of the heart are reduced, Ht — 38 %. The diuresis is reduced. An increase of renin activity is revealed in the blood.

Questions:

1. Are there any signs of water exchange impairments?
2. What type of dishydria is present in the patient?
3. Are the liquid accumulations in the hypodermic cellular tissue, abdominal cavity and in the lungs etiologically associated?
4. What is the pathogenesis of biochemical deviations revealed in the patient's blood?
5. What are the mechanisms of edema development in the given patient?
6. Evaluate the significance of edema for the patient's organism.
7. What is the way to prevent the edema development in this patient?

№ 4

The patient of 22 years. In 2 weeks after scarlet fever suffered in a severe form he started complaining of headaches, pains in the lumber area, breathlessness, palpitation. For the last week she gained 11.5 kg of body weight. Objectively: the face is pale, the eyelids are swelled, eye slots are narrowed. Legs and feet are pastosed. The heart borders are dilated, BP — 180/100 mm Hg. The diuresis is sharply reduced, in the urine — erythrocytes and protein. The titer of anti-streptococcal antibodies in the blood is increased.

Questions:

1. Are there any bases to consider, that the patient developed renal impairment? If yes, what is a possible mechanism of this pathology?
2. What caused the developed hyperhydration: sharp decrease of the secretory renal function or intensification of mechanisms of active water retention in the organism?

What are the development mechanisms of the given type of edema?

The development mechanism of nephrotic edema

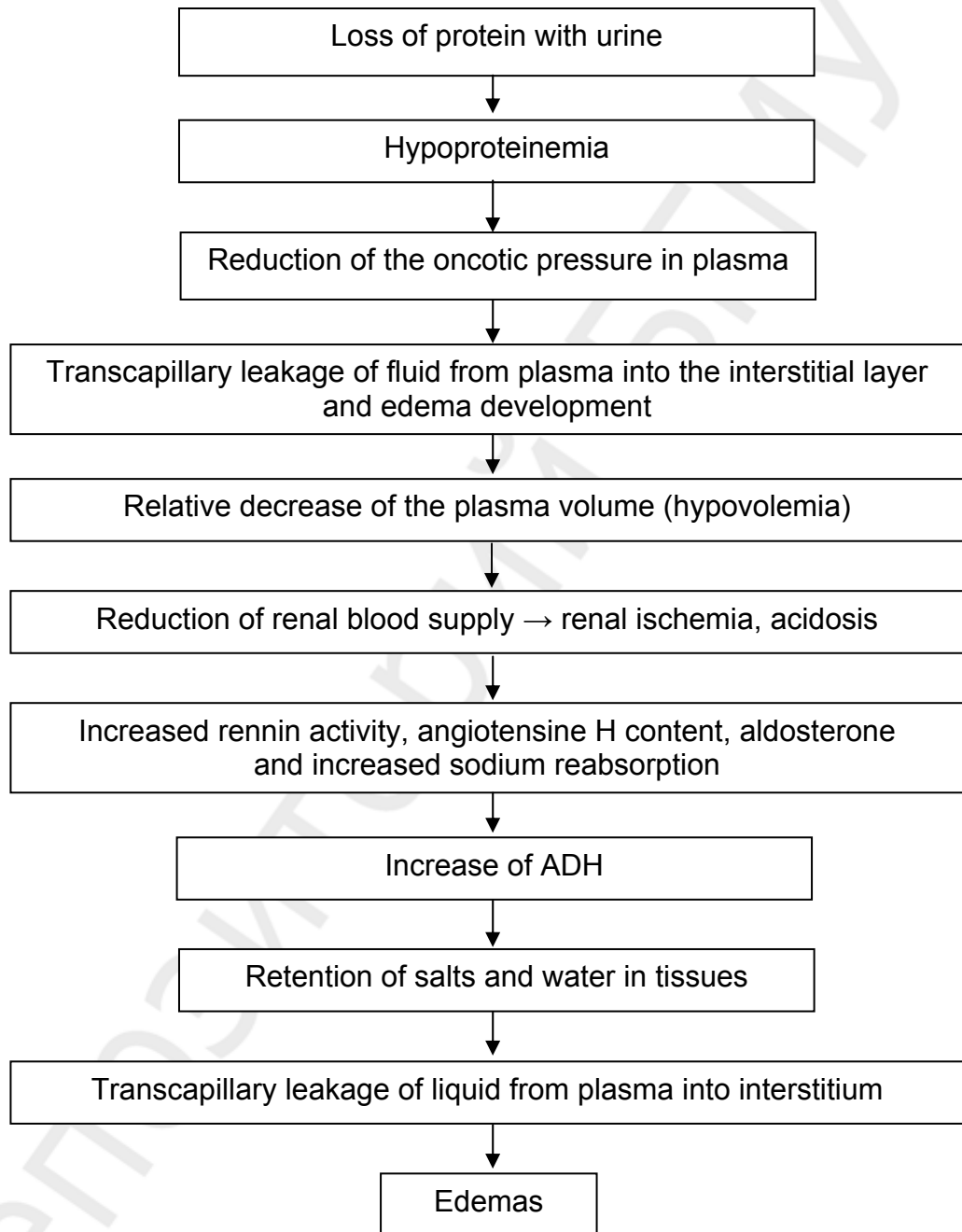

The development mechanism of a nephritic edema

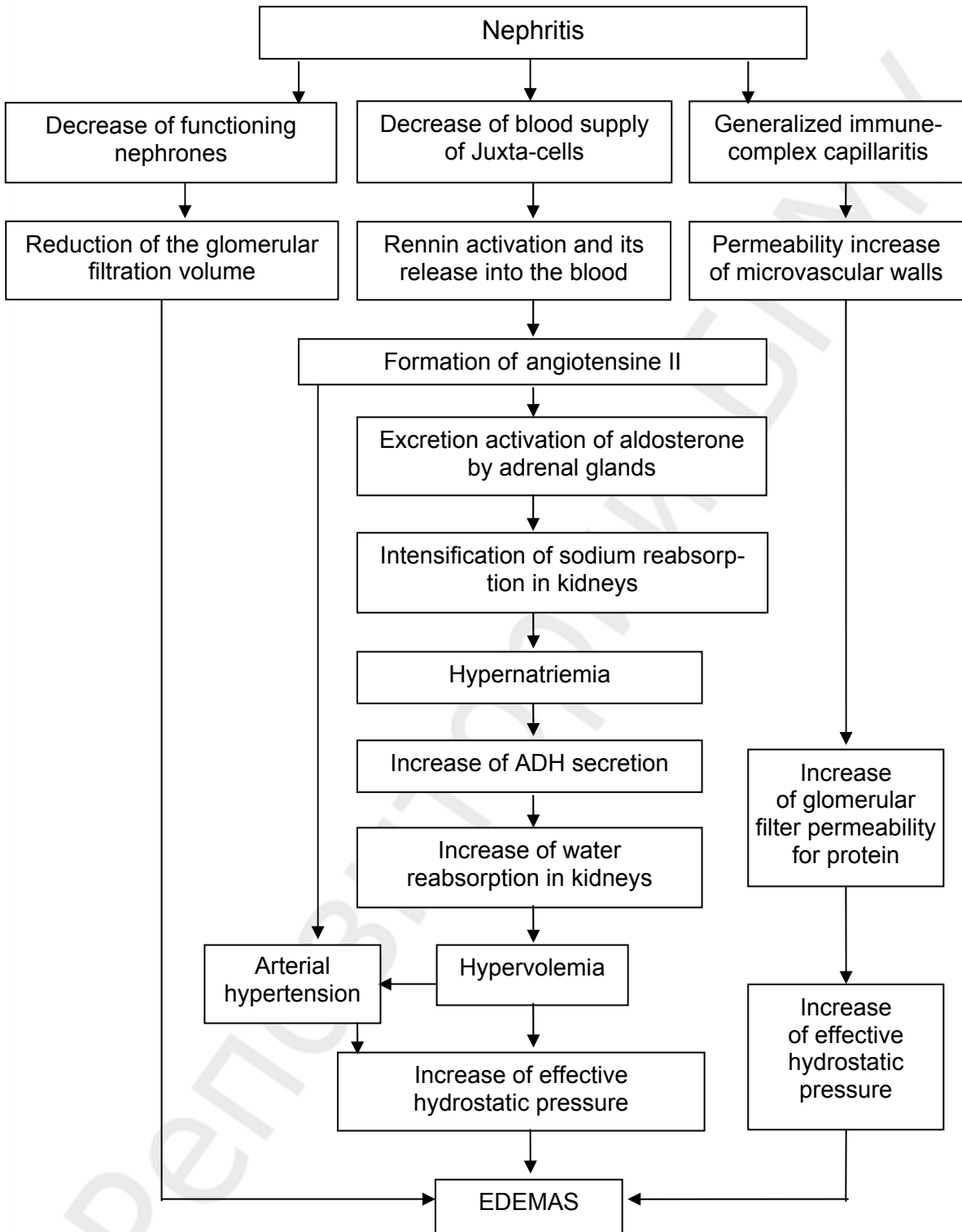

The development mechanism of cardiac edemas

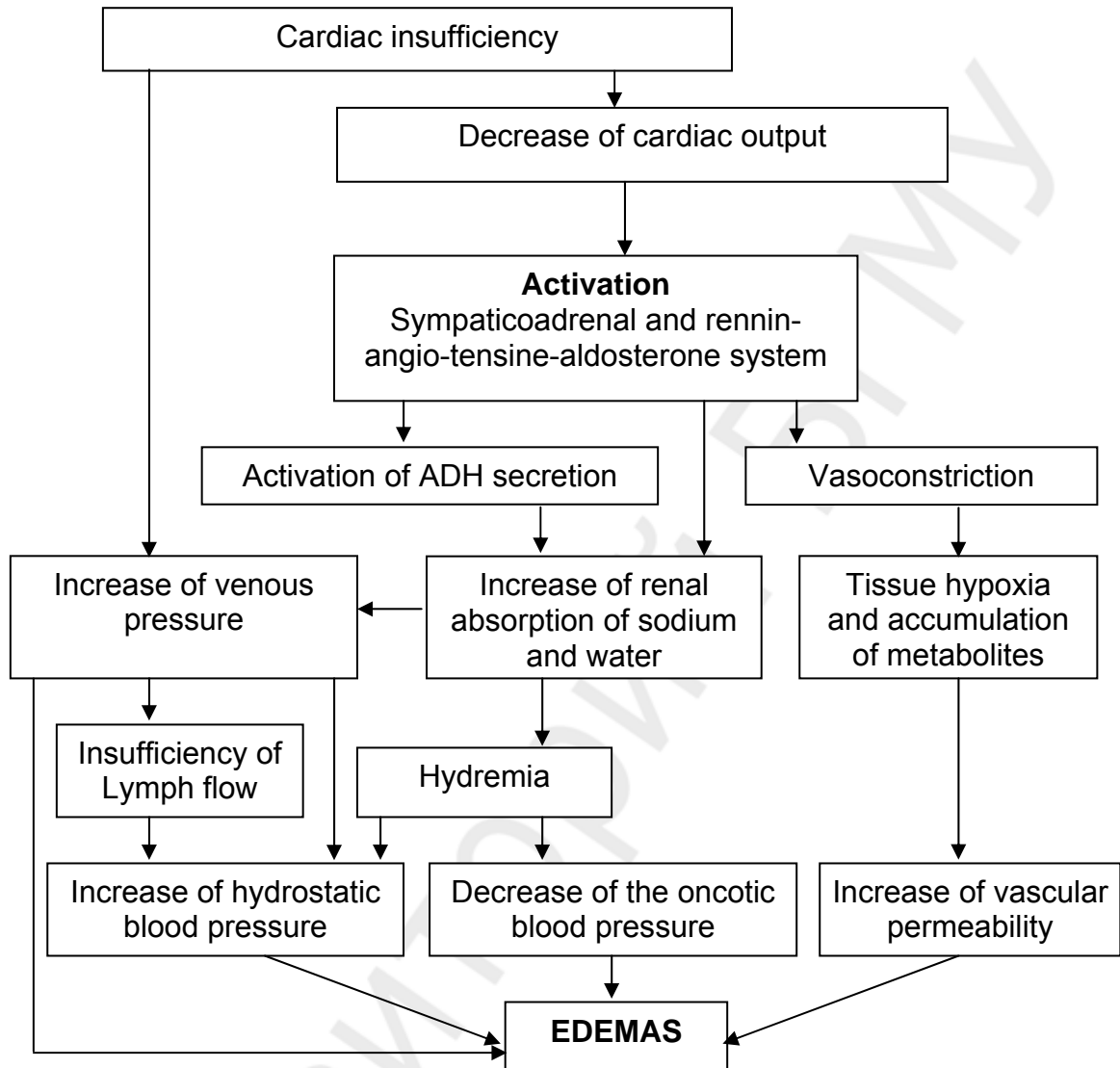

The development mechanism of ascites in liver cirrhosis

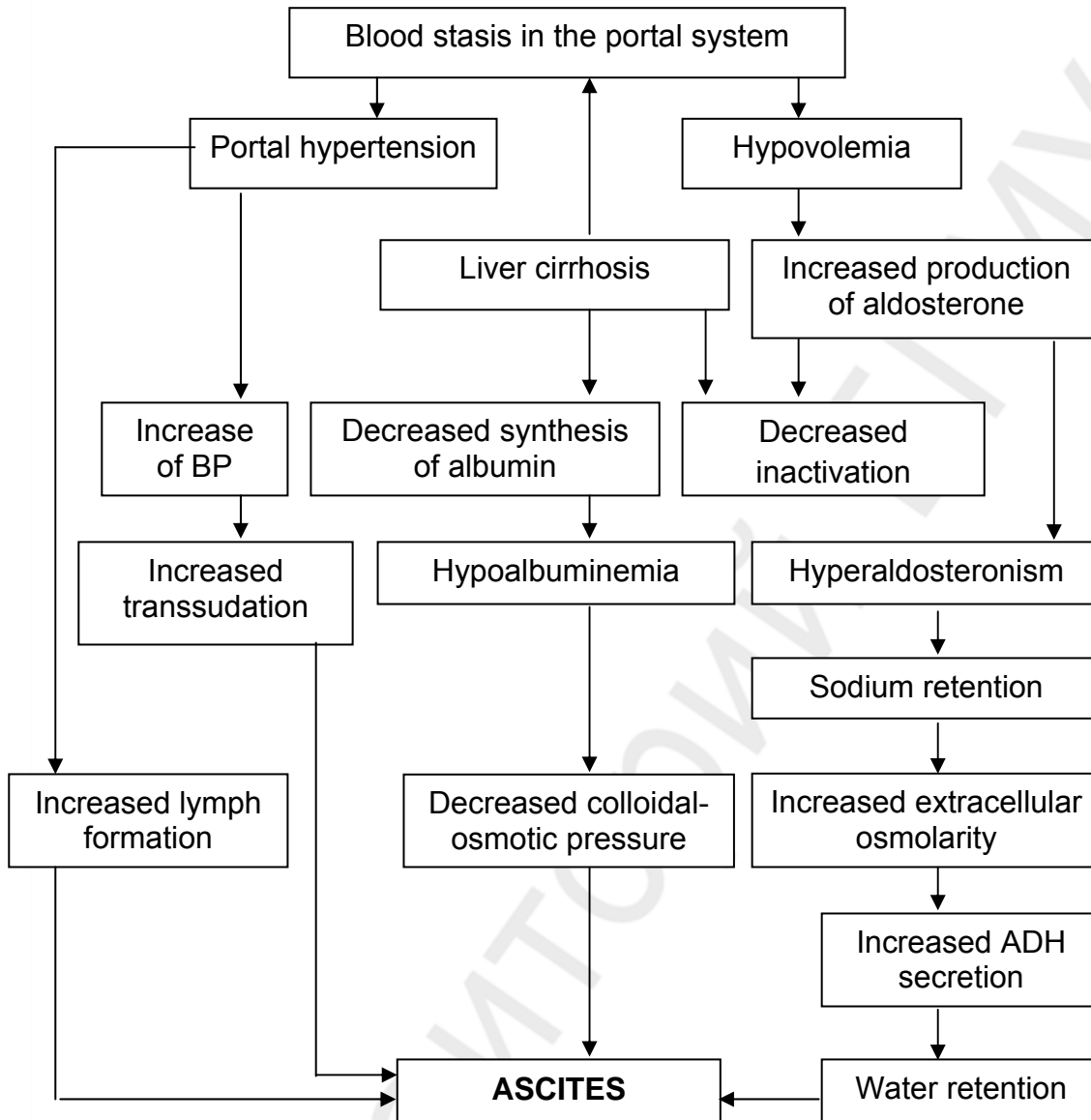

LESSON 9. TYPICAL THERMOREGULATION IMPAIRMENTS. FEVER

SITUATIONAL TASKS

№ 1

The experiments on normal and tolerant to bacterial pyrogen rabbits determined pyrogenic properties of blood serums obtained in various intervals after intravenous injection of a bacterial pyrogen to experimental animals.

It turned out, that injection the rabbit the serum taken in 5 min after the injection of a bacterial pyrogen, results in the development of fever with a long latent period in the normal rabbit and does not cause fever in the tolerant rabbit. The injection of the serum taken in 120 min after the injection of a bacterial pyrogen causes the development of a feverish reaction both in the normal and in the tolerant rabbit; the fever in normal rabbits develops in a shorter latent period.

1. Why does the serum taken in 120 min after the injection of a bacterial pyrogen produce a pyrogenic action being injected to tolerant rabbits unlike the serum received in 5 min after the injection of a bacterial pyrogen?

2. How can you explain a shorter latent period of a feverish reaction in normal animals, when they are injected the serum taken in 120 min after the injection of pyrogenal, as compared to tolerant rabbits?

№ 2

The rabbit staying at the temperature of the environment of +2 °C was injected pyrogenal in the dose that in 90 min after the injection resulted in elevation of body temperature up to 39.5 °C. After that the rabbit was transferred to a room with the environmental temperature of +20 °C.

Will such change of the environmental temperature cause an additional elevation of the body temperature of the rabbit?

№ 3

Is the character of functional changes in the development of fever presented correctly on the scheme below? If not, what is a mistake?

Aseptic inflammation → activation of neutrophiles, monocytes, tissue macrophages → synthesis and entrance of exo- and endogenic pyrogens into the blood from activated cells → action of thermoregulation on hypothalamic centers → an increase of excitability of heat-sensitive and cold-sensitive neurons of thermoregulatory structures → intensification of heat production and heat emission → elevation of the body temperature.

№ 4

Is the character and sequence of functional changes on the scheme presented correctly in the development of fever induced by the injection of a bacterial pyrogen? If not, what is a mistake?

Bacterial pyrogen → destruction of tissues → release of endogenous pyrogens from the destroyed tissues → their entrance into the blood → action of exo- and endogenous pyrogens on hypothalamic centers of thermoregulation → excitability decrease of heat-sensitive and cold-sensitive neurons of thermoregulatory structures → restriction of heat emission → intensification of heat production → elevation of body temperature.

LESSON 10. TYPICAL IMPAIRMENTS OF METABOLISM. IMPAIRMENTS OF THE ACID-BASE STATE OF THE INTERNAL ENVIRONMENT OF THE ORGANISM

The analysis plan of a type of ABS impairments

1. Acidosis/alkalosis.
2. Compensated/decompensated acidosis/alkalosis (on pH change).
3. Type of acidosis/alkalosis on the origin (according to clinical anamnesis).
4. Evaluate triggering of compensatory mechanisms (criteria: laboratory parameters testifying to **hyperfunction** of the respiratory or metabolic system of pH regulation).

SITUATIONAL TASKS

№ 1

A group of tourists from the middle region of the European part of the CIS is delivered by air to a tourist camp on Pamir, 2500 m over the sea level. Several persons began complaining of tiredness, weakness, early fatigue. While examining one of them on the 2-nd day of staying in the camp the following parameters of the acid-base state were revealed:

$\text{pH}_{\text{arterial blood}} = 7.46;$
 $\text{p}_a\text{CO}_2 = 32 \text{ mm Hg};$
 $\text{HCO}_3^- = 22 \text{ mmol/l};$
 $\text{BE} = -1 \text{ mmol/l};$
 $\text{pH}_{\text{urine}} = 6.0;$
 $\text{TK of urine} = 20 \text{ mmol/day}.$

In a week the patient's condition improved. ABS parameters were the following:

$\text{pH}_{\text{arterial blood}} = 7.38;$
 $\text{p}_a\text{CO}_2 = 30 \text{ mm Hg};$
 $\text{HCO}_3^- = 17 \text{ mmol/l};$
 $\text{BE} = -6 \text{ mmol/l};$

$$\text{pH}_{\text{urine}} = 7.2;$$

Bicarbonates in the urine;

$$\text{TK of urine} = 0.$$

Make a conclusion regarding the character of ABS impairments.

№ 2

The patient of 56 years suffers from pulmonary emphysema and respiratory insufficiency.

ABS parameters and of electrolyte balance:

$$\text{pH}_{\text{arterial blood}} = 7.37;$$

$$\text{p}_a\text{CO}_2 = 56 \text{ mm Hg};$$

$$\text{HCO}_3^- = 32 \text{ mmol/l};$$

$$\text{Na}^+ = 142 \text{ mmol/l};$$

$$\text{K}^+ = 4 \text{ mmol/l};$$

$$\text{Cl}^- = 88 \text{ mmol/l}.$$

Make the conclusion regarding the character of ABS impairments.

№ 3

The patient suffering for many years from diabetes was admitted to hospital in a coma. Parameters of ABS and electrolyte balance on admission:

$$\text{pH}_{\text{arterial blood}} = 6.95;$$

$$\text{p}_a\text{CO}_2 = 20 \text{ mm Hg};$$

$$\text{HCO}_3^- = 5.5 \text{ mmol/l};$$

$$\text{BE} = -20 \text{ mmol/l};$$

$$\text{SB} = 4 \text{ mmol/l};$$

$$\text{Ketonic bodies in blood plasma} = 10 \text{ mmol/l};$$

$$\text{K}^+ = 7.5 \text{ mmol/l};$$

$$\text{TK of urine} = 60 \text{ mmol/l};$$

Ketonic bodies in urine.

Make the conclusion regarding ABS and possible approaches for its correction.

№ 4

The patient suffers from diffuse glomerulonephritis for 10 years. He was admitted to hospital due to expressed renal insufficiency. Olyguria.

ABS parameters and electrolyte balance:

$$\text{pH}_{\text{arterial blood}} = 7.27;$$

$$\text{p}_a\text{CO}_2 = 27 \text{ mm Hg};$$

$$\text{HCO}_3^- = 15.5 \text{ mmol/l};$$

$$\text{BE} = -10 \text{ mmol/l};$$

$$\text{SB} = 15 \text{ mmol/l};$$

Concentration of trace anions in plasma = 21 mmol/l;

$K^+ = 5.8$ mmol/l.

Make the conclusion regarding the character of ABS impairments.

№ 5

The patient was admitted to the first aid hospital in the condition of asphyxia. The blood test revealed:

$pH_{\text{art. blood}} = 7.0$;

$p_aCO_2 = 80$ mm Hg;

$HCO_3^- = 19$ mmol/l;

BE = -8 mmol/l;

SB = 18 mmol/l;

BB = 37 mmol/l;

Lactate = 4.5 mmol/l.

Make the conclusion regarding the character of ABS impairments.

№ 6

The patient was admitted to clinic in a severe condition. Extensive infarction of anterior lateral walls of the left ventricle, acute left-ventricular cardiac insufficiency, pulmonary edema was diagnosed. While estimating ABS parameters the following data were received:

$pH_{\text{art. blood}} = 7.22$;

$p_aCO_2 = 55$ mm Hg;

$HCO_3^- = 20$ mmol/l;

BE = -5 mmol/l;

Lactate = 4.76 mmol /l.

Make the conclusion regarding the character of ABS impairments.

№ 7

The patient, 46 years, was admitted to clinic with an extensive trauma (multiple fractures of bones, damage of soft tissues), accompanied by a massive blood loss. On admission the consciousness is inhibited, the skin is pale, cold and damp with sweat. BP is 95/60 mm Hg. Pulse — 120 beats/min. Marked breathlessness, thirst. Olyguria.

On ABS investigation the following data are received:

$pH_{\text{art. blood}} = 7.26$;

$p_aCO_2 = 28$ mm Hg;

$HCO_3^- = 14.5$ mmol/l;

BE = -12 mmol/l;

SB = 14 mmol/l;

Lactate = 6.8 mmol/l.

Make the conclusion regarding the character of ABS impairments.

№ 8

The patient has peritonitis, paralytic intestinal obstruction, fever. Loss of liquid is 6 l. Olyguria. On investigation of ABS parameters and electrolyte balance the following data are received:

$\text{pH}_{\text{art. blood}} = 7.15$;

$\text{p}_a\text{CO}_2 = 25 \text{ mm Hg}$;

$\text{HCO}_3^- = 12 \text{ mmol/l}$;

$\text{BE} = -20 \text{ mmol/l}$;

$\text{SB} = 15 \text{ mmol/l}$;

Lactate = 6.2 mmol/l;

Ketonic bodies in blood plasma = 3.7 mmol /l;

Potassium = 6.5 mmol/l;

Concentration of trace anions in plasma = 26 mmol/l;

Reduced content of K^+ in erythrocytes.

Characterize the type of ABS impairment.

№ 9

Patient B., 13 years, with acute poliomyelitis on the 4-th day of the disease noted the difficulty of respiration, due to which he was administered artificial pulmonary ventilation (APV).

Investigation results of ABS are presented in the table:

Parameters	Before APV	In 2 h after APV was started
$\text{pH}_{\text{art. blood}}$	7.26	7.46
p_aCO_2	62 mm Hg	30 mm Hg
HCO_3^-	26 mmol/l	18mmol /l
BB	43 mmol/l	40 mmol/l
SB	22 mmol/l	20mmol l/l
BE	1 mmol/l	-2.2 mmol/l

1. What form of ABS impairment took place in the child before artificial pulmonary ventilation?

2. Draw the conclusion regarding the character of ABS impairment in 2 h after APV.

3. Is the volume of pulmonary ventilation during APV established correctly?

№ 10

Patient Z., 16 years, was admitted to clinic with acute pneumonia. The condition is heavy. The body temperature is 39.8 °C. Expressed breathlessness.

The anamnesis revealed no pulmonary pathology.

The investigation of ABS parameters revealed:

$\text{pH}_{\text{art. blood}} = 7.47$;

$\text{paCO}_2 = 29 \text{ mm Hg}$;

$\text{HCO}_3^- = 22 \text{ mmol/l}$;

$\text{BE} = -1.8 \text{ mmol/l}$.

1. What ABS impairment is present in the patient?
2. What is the cause?

№ 11

Patient K., 38 years, is delivered to hospital with an attack of titanic spasms.

Questioning of the patient revealed that about half a year ago he got into a car accident. Has received an open fracture of the right humeral bone. Fracture knitting occurred in usual terms. But since then he had been suffering from strong heartburn and to relieve it he constantly takes baking soda.

The investigation of ABS parameters revealed:

$\text{pH}_{\text{art. blood}} = 7.50$;

$\text{paCO}_2 = 43 \text{ mm Hg}$;

$\text{HCO}_3^- = 32 \text{ mmol/l}$;

$\text{BE} = +12 \text{ mmol/l}$.

1. What kind of ABS impairment developed in the patient?
2. What is a direct cause of the impairment of the acid-base balance in this case?
3. Can these changes of the acid-base state result in the development of tetania?

№ 12

Patient M., 37 years, was delivered to the intensive care department with acute poisoning with sleeping draughts.

The investigation of ABS parameters revealed:

$\text{pH}_{\text{art. blood}} = 7.29$;

$\text{paCO}_2 = 56 \text{ mm Hg}$;

$\text{HCO}_3^- = 25 \text{ mmol/l}$;

$\text{BE} = +1 \text{ mmol/l}$.

1. What form of ABS impairment is present in the patient?

2. Is there any necessity of administering sodium bicarbonate in this case to correct the impaired acid-base state?

№ 13

ABS shifts were studied in the group of sportsmen under the conditions of growing loadings on the veloergometer. The loading in decathlonist B., 24 years, was started from 150 Wt and it was increased by 50 Wt every 2 min till the individual maximum. Immediately after the loadings the acid-base state was investigated. Meanwhile it was revealed:

$\text{pH}_{\text{art. blood}} = 7.29$;
 $\text{paCO}_2 = 30 \text{ mm Hg}$;
 $\text{HCO}_3^- = 18 \text{ mmol/l}$;
 $\text{BE} = -11 \text{ mmol/l}$.

1. In what way did ABS change in the sportsman as a result of significant physical loading?
2. What is a probable cause of ABS impairment in this case?
3. How can the decrease of paCO_2 parameter be explained?

№ 14

Patient M., 54 years, was delivered to hospital in a grave condition. He complained of general weakness, heavy loss of weight. For the last 5–6 days almost after each meal he feels a pain in the epigastric area accompanied by vomiting.

The investigation of ABS parameters revealed:

$\text{pH}_{\text{art. blood}} = 7.55$;
 $\text{paCO}_2 = 60 \text{ mm Hg}$;
 $\text{HCO}_3^- = 50 \text{ mmol/l}$;
 $\text{BE} = 18 \text{ mmol/l}$.

1. Make a conclusion regarding the character of ABS impairment.
2. What is a possible cause of ABS impairment in this patient?

№ 15

Child D., 4 years, was delivered to hospital due to elevation of the body temperature and frequent loose stool (8–10 times a day). On examination moderate dehydration and breathlessness were noted.

The investigation of ABS parameters revealed:

$\text{pH}_{\text{art. blood}} = 7.39$;
 $\text{paCO}_2 = 27 \text{ mm Hg}$;
 $\text{HCO}_3^- = 17 \text{ mmol/l}$;
 $\text{BE} = -8 \text{ mmol/l}$.

1. Make a conclusion regarding the character of ABS impairment.
2. What is a possible cause of ABS impairment in the child?

№ 16

Patient L., 48 years, with diabetes was delivered to hospital in a heavy pre-comatose condition. The patient was administered a complex therapy, including, insulin intramuscularly and solution of sodium bicarbonate intravenously. The results of KOC investigation are presented in the table:

Parameter	Before treatment	On the 2nd day of treatment	On the 3rd day of treatment
pH	7.28	7.34	7.44
pCO ₂	20 mm Hg	36 mm Hg	49 mm Hg
BB	31 mmol/l	39 mmol/l	51 mmol/l
HCO ₃ ⁻	12 mmol/l	18 mmol/l	29 mmol/l
BE	-18 mmol/l	-9 mmol/l	6 mmol/l

1. Specify the type of KOC impairment on admission and on the 2-nd and 3-rd day of treatment.
2. Is there any necessity for further introduction of sodium bicarbonate to the patient?

ADDITIONAL INFORMATION

Classification of ABS impairments

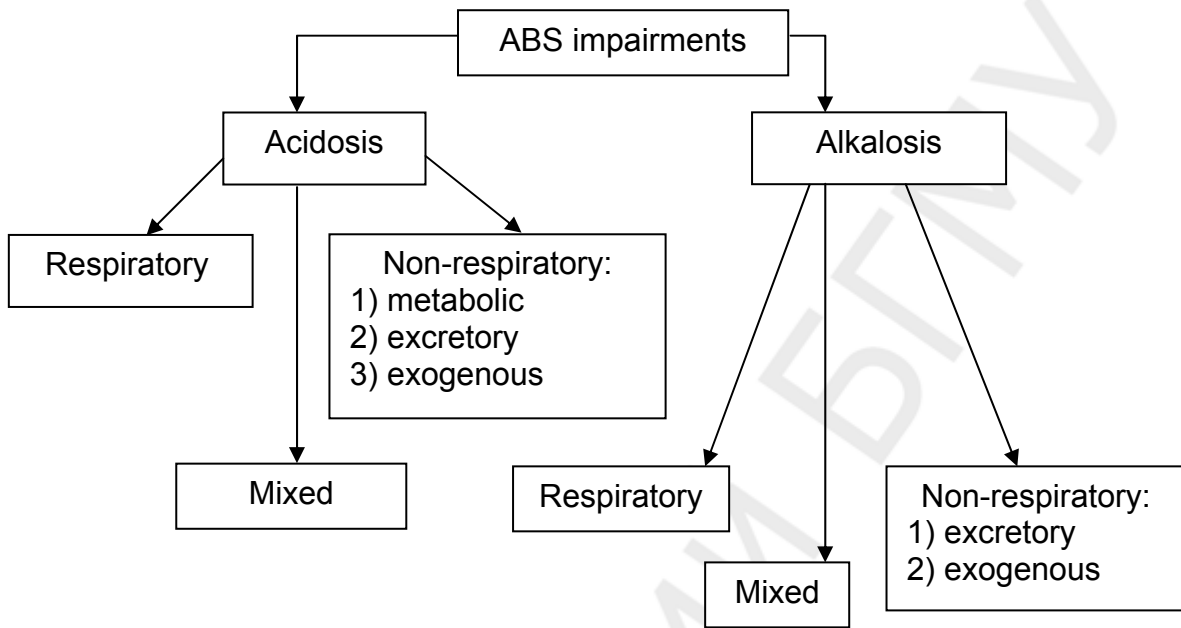

Principal development causes of non-respiratory acidoses (on J. Sheiman, 1999)

With anion deficiency	Without anion deficiency
1. Ketoacidosis: diabetes, fasting. 2. Lactate-acidosis: heavy physical exertion, hypoxia, shock, poisoning with carbon oxide. 3. Uraemia. 4. Acute poisoning with toluene, methanole, ethylenglycole	1. Losses of HCO_3^- through gastrointestinal tract (diarrhea). 2. Losses of HCO_3^- with urine during restoration after gas alkalosis. 3. Decrease of HCO_3^- reabsorption in kidneys in the impairment of H^+ secretion in nephron canaliculi

**LESSON 11. TYPICAL IMPAIRMENTS OF TISSUE GROWTH. TUMOURS.
BIOLOGICAL PECULIARITIES. METHODS OF EXPERIMENTAL REPRODUCTION.
ETIOLOGY OF TUMOURS**

SITUATIONAL TASKS

№ 1

Can a good ventilation of premises be considered as one of the measures of cancer prophylaxis? Prove your conclusion.

№ 2

Why does an European type of diet result in an incidence increase of cancer of the large intestine?

№ 3

Why is the incidence of gastric cancer in the Caucasus essentially lower, than on an average across the CIS?

№ 4

Under the influence of technogenic contamination the thickness of the ozone layer decreases. Will it affect the incidence of skin cancer?

№ 5

Why does skin cancer occur more often in the Ukraine and in Baltic states, than in Central Asia?

№ 6

What is a high incidence of melanoma in Australia associated with?

№ 7

Why does breast cancer occur in Estonia 5 times more often, than in Tadjikistan?

№ 8

A woman, whose mother had breast cancer, referred to the doctor. The woman is of increased nutrition, suffers from hypertension. No pathology was revealed in her mammary glands. What are the recommendations?

LESSON 12. TYPICAL IMPAIRMENTS OF TISSUE GROWTH. PATHOGENESIS OF TUMOURS. SYSTEMIC ACTION OF THE TUMOUR ON THE ORGANISM

ADDITIONAL INFORMATION

Functions of cellular oncogens (according to J. Henderson, 1999) and oncoproteins

Class 1. Growth factors	
sis	TGF growth factor
int-2	FGF growth factor
Class 2. Receptor and non-receptor tyrosine proteinkinases	
src	Membrane-linked non-receptor tyrosine proteinkinase
fps/fes	Non-receptor tyrosine proteinkinase
abl/bcr-abl	Non-receptor tyrosine proteinkinase
erB	Receptor tyrosine proteinkinase linked with epidermal growth factor
trk	Receptor-like linked tyrosine proteinkinase
Class 3. Receptors having no proteinkinase activity	
mas	Angiotensine receptor
Class 4. Membrane-bound G-proteins	
H-ras	Located on membrane GTF-dependent/GTPase
K-ras	Located on membrane GTF-dependent /GTPase
gsp	Mutant activated form G α
gip	Mutant activated form G α
Class 5. Cytoplasmatic proteinserine kinases	
raf/mil	Cytoplasmatic serine proteinkinase
pim-1	Cytoplasmatic serine proteinkinase
Class 6. Cytoplasmatic regulators	
crk	SH-2/3 protein linking (and regulating) proteins containing phosphotyrosine
Class 7. Nuclear factors of transcription	
Myc	Protein specifically linked with DNA
N-myc	Protein specifically linked with DNA
Myb	Protein specifically linked with DNA
fos	It is combined with c-jun derivatives forming AP-1 transcription factor
jun	Protein specifically linked with DNA, part AP-1
erbA	Dominant negative mutant tyroxine receptor
NOT CLASSIFIED	
bcl-2	Plasmatic carrier of signals to membranes

Some anti-oncogens (on A. S. Zajchiku, L. P. Churilovu, 1999)

Category	Action mechanism	Is suppressed in the following neoplasms
Cellular cycle breakers: p53 Rb	Inductor of adaptosis Links viral promotors of E2F and E1A growth factors, a kaspase target in apoptosis. Cellular cycle breaker	Many (e.g., carcinomas of the bladder, lung, ovary, retinoblastoma) Retinoblastoma, osteosarcoma, microcellular cancer of the lung
GTPhasal activators and G-proteins: NF1 MCC	Inhibitor of G-proteins, ras antagonist Attenuates the transmission of a growth signal by G-proteins	Sarcoma, gliomas, MEN a 1-syndrome the cancer of the large intestine
DNA reparators	Reparases	Carcinomas of the large intestine Cancer of the endomerium
Adhesive molecules: VHL DCC NF-2	Adhesion receptor Attachment of the cytoskeleton to a membrane	Hemangioblastoma, pheochomocytoma, cancer of the kidney Cancer of the large intestine Shwanoma
Blockers of hormonal growth signal BRCA 1-2	Inhibits the growth effect of estrogens (?)	Carcinomas of the mammary gland and ovarian

Flow-chart of pathogenesis of malignant neoplasms

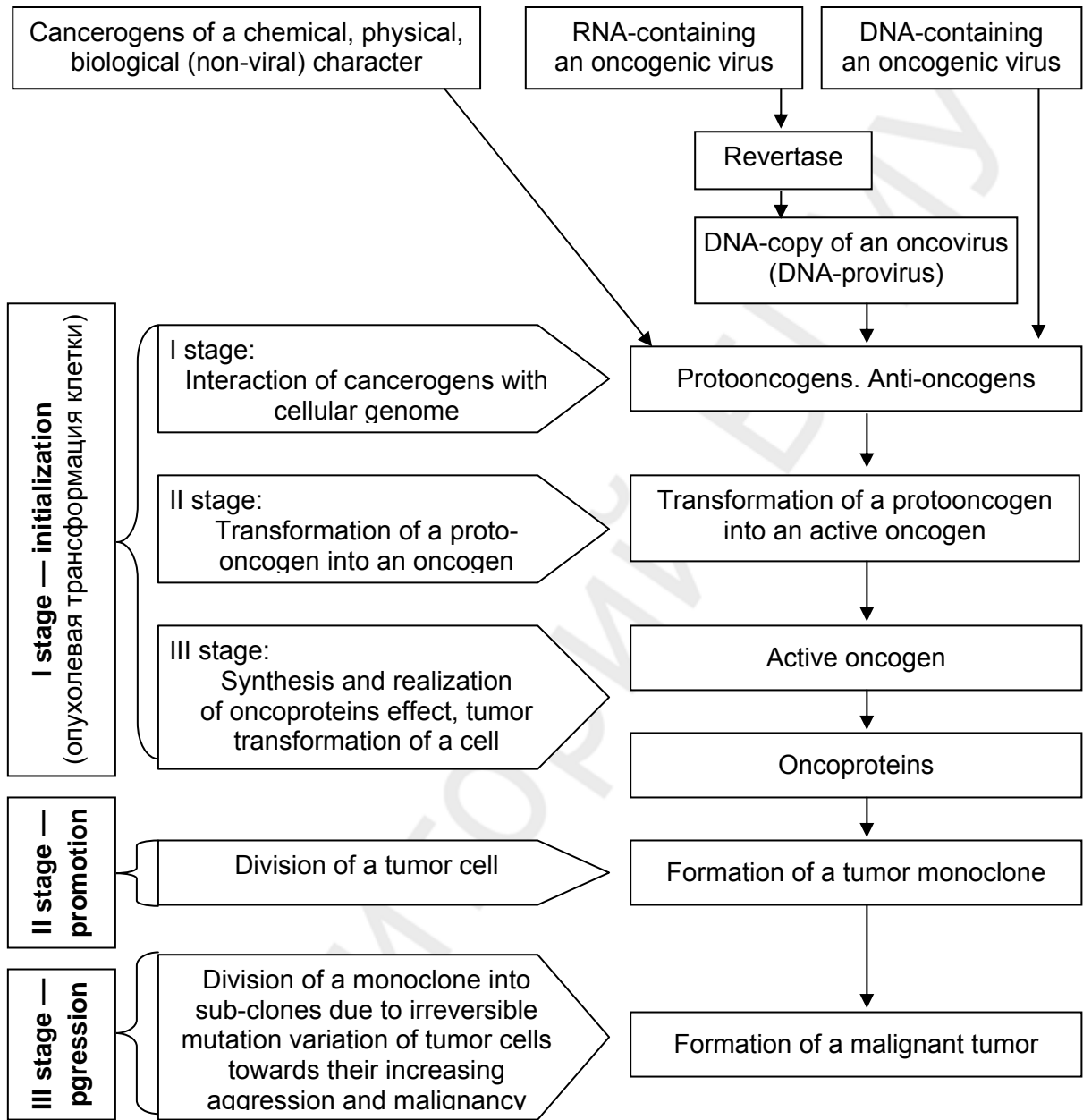

SECTION III
SPECIFIC PATHOPHYSIOLOGY

LESSONS 1–7. PATHOPHYSIOLOGY OF THE BLOOD SYSTEM

SITUATIONAL TASKS

№ 1

Patients I. was admitted to hospital with a closed trauma of the abdomen, fractures of the leg in 20 min after a car accident. The patient is pale, experiences severe dizziness, his pulse is 120 beats/min, of weak filling; respiration is superficial (30 resp./min); BP — 90/50 mm Hg.

Blood test on admission:

Erythrocytes	$4.5 \times 10^{12}/l$	
Hemoglobin	140 g/l	
Color factor	calculate	
Leukocytes	$8.0 \times 10^9/l$	
basophiles	0.5 %	
eosinophiles	3 %	
neutrophiles:		
– rod nuclear	1 %	
– segmentated	58 %	
lymphocytes	30 %	
monocytes	7.5 %	
Conclusion:		

1. Explain the origin of the patient's symptoms:
 - paleness of the integuments;
 - dizziness;
 - accelerated superficial respiration;
 - hypotension;
 - tachycardia.
2. Explain why there is a divergence of the clinical picture and laboratory findings (normal factors of the hemogram).
3. What is your suggested diagnosis?

№ 2

Patient K., 34 years, was admitted to the in-patient department with suspicion to gastric bleeding. The laboratory examination revealed:

Blood test on admission:

Erythrocytes	$3.0 \times 10^{12}/l$	
Hemoglobin	100 g/l	

Reticulocytes	0.7 %	
Color factor	calculate	
Leukocytes	$3.4 \times 10^9/l$	
basophiles	0 %	
eosinophiles	1 %	
neutrophiles:		
– young	0 %	
– rod nuclear	5 %	
– segmentated	45 %	
lymphocytes	40 %	
monocytes	9 %	
Thrombocytes	$120 \times 10^9/l$	
Conclusion:		

1. Are the obtained findings of the blood test characteristic of an acute blood loss?
2. Explain what the decrease of the thrombocyte content is due to in the peripheral blood in this case.
3. In what terms after an acute blood loss are the clinical manifestations of a hydremic reaction revealed?

№ 3

Patient Sh., 54 years. His blood test is made on the 5th day after a surgical intervention for the rupture of gastric ulcer.

Blood test on admission:

Erythrocytes	$3.6 \times 10^{12}/l$	
Hemoglobin	98 g/l	
Reticulocytes	3.8 %	
HCT (hematocrit)	33 %	
Color factor	calculate	
MCV	calculate	
MCH	calculate	
Leukocytes	$16 \times 10^9/l$	
basophiles	1 %	
eosinophiles	3 %	
neutrophiles:		
– myelocytes	1 %	
– young	2 %	
– rod nuclear	8 %	
– segmentated	64 %	
lymphocytes	18 %	
monocytes	3 %	
In the smear: unmarked anisocytosis, poikilocytosis		
Conclusion:		

1. Characterize the patient's changes in the peripheral blood.

2. Which of these changes testify to triggering of compensatory mechanisms on the part of hemopoiesis?
3. What are the effects of hemopoiesis stimulation in this case?
4. Characterize anemia by basic criteria.

№ 4

Patient L., 40 years, was admitted to clinic to undergo examination for abdominal pains of the unclear etiology, from time to time she noted her stool to be of a dark color.

Blood test on admission:

Erythrocytes	$3.8 \times 10^{12}/l$	
Hemoglobin	77 g/l	
Reticulocytes	1.2 %	
HCT (hematocrit)	28 %	
Color factor	calculate	
MCV	calculate	
MCH	calculate	
RDW	15.2 %	
Leukocytes	$5.4 \times 10^9/l$	
basophiles	1 %	
eosinophiles	2 %	
neutrophiles:		
– young	0 %	
– rod nuclear	6 %	
– segmentated	54 %	
lymphocytes	30 %	
monocytes	7 %	
Thrombocytes	$280 \times 10^9/l$	
In the smear: erythrocytes of irregular shape, anuloocytes		
Conclusion:		

1. What changes of the peripheral blood content has the patient?
2. Characterize anemia by basic criteria.
3. Of what pathology are similar changes in the blood characteristic?
4. To what do the changes of erythrocyte indices in the blood testify?

№ 5

Patient M., 14 years, complained of general weakness, dizziness, frequent fainting. Nutrition is decreased. Recently she noted taste perversion, craving for chalk, burnt crusts of brown bread etc. She had periods — since 13 years, irregular, profuse.

Blood test on admission:

Erythrocytes	$3.8 \times 10^{12}/l$	
--------------	------------------------	--

Hemoglobin	78 g/l	
Hematocrit	1.2 %	
Reticulocytes	0.8 %	
Color factor	calculate	
MCV	calculate	
MCH	calculate	
RDW	16.1 %	
Leukocytes	$6.7 \times 10^9/l$	
basophiles	0 %	
eosinophiles	3 %	
neutrophiles:		
– young	0 %	
– rod nuclear	2 %	
– segmentated	52 %	
lymphocytes	37 %	
monocytes	6 %	
Thrombocytes	$270 \times 10^9/l$	
Conclusion:		

1. Characterize anemia by basic criteria.
2. What disease has this patient?
3. What is the concept of a pathogenetic therapy of this disease?

№ 6

Patient B., 54 years, was admitted to clinic with complaints of acute weakness, breathlessness on the slightest physical exertion, numbness of finger tips and pain in the tongue.

Blood test on admission:

Erythrocytes	$1.44 \times 10^{12}/l$	
Hemoglobin	66 g/l	
Reticulocytes	0.1 %	
Color factor	calculate	
Leukocytes	$2.8 \times 10^9/l$	
basophiles	0 %	
eosinophiles	5 %	
neutrophiles:		
– young	0 %	
– rod nuclear	1 %	
– segmentated	43 %	
lymphocytes	48 %	
monocytes	3 %	
Thrombocytes	$100 \times 10^9/l$	
In the smear: clearly marked anisocytosis, poikilocytosis, megaloblasts, megalocytes, erythrocytes with basophile granulation, hyper segmented neutrophiles		
Conclusion:		

1. Of what pathology are the revealed changes of the peripheral blood content characteristic?
2. What type of erythropoiesis takes place in this pathology?

№ 7

Patient N., 44 years is being examined in the in-patient department with increasing weakness, early fatigue, breathlessness. Three years ago he underwent a surgery for intestinal obstruction. There was performed a resection of 60 cm of the small intestine with application of a side-to-side anastomosis. Since then periodic abdominal pains and an unstable stool are noted.

Blood test on admission:

Erythrocytes	$1.89 \times 10^{12}/l$	
Hemoglobin	81 g/l	
Reticulocytes	26 %	
HCT (hematocrit)	0.1 %	
Color factor	calculate	
MCV	calculate	
MCH	calculate	
RDW	18 %	
Leukocytes	$3.5 \times 10^9/l$	
basophiles	1 %	
eosinophiles	0.5 %	
neutrophiles:		
– young	0 %	
– rod nuclear	0.5 %	
– segmentated	58 %	
lymphocytes	34 %	
monocytes	6 %	
Thrombocytes	$120 \times 10^9/l$	
In the smear: single megalocytes, megaloblasts, giant polysegmented nuclear neutrophiles		
Conclusion:		

1. What pathology does this test reveal?
2. Can you suggest the development mechanism of the revealed blood pathology on the basis of the available data?
3. The deficiency of what most probable factor caused the development of anemia in this case?
4. Characterize anemia by basic criteria.

№ 8

Patient P., 69 years, referred with complaints of weakness, dizziness, breathlessness on the slightest exertion.

Four years ago he was diagnosed a malignant melanoma of the left leg with metastases into the lungs. A surgical resection of the primary tumor was performed and a course of chemotherapy was administered, the growth of lung metastases being arrested. During the following 3 years the patient didn't present any complaints.

Half a year ago, during a follow-up examination the metastases in the pelvic bones were revealed. At present the patient is undergoing a repeated course of chemotherapy.

Blood test on admission:

Erythrocytes	2.26×10 ¹² /l	
Hemoglobin	83g/l	
Hematocrit	23.9 %	
Reticulocytes	0.1 %	
MCV	106 phl	
MCH	37 pgcell	
MCHC	34.6 g/dcl	
RDW	23 %	
Leukocytes	3.5×10 ⁹ /l	
basophiles	0 %	
eosinophiles	1 %	
neutrophiles:		
– young	0 %	
– rod nuclear	3 %	
– segmentated	79 %	
lymphocytes	9 %	
monocytes	8 %	
Thrombocytes	105×10 ⁹ /l	
In the smear: giant polysegmentated nuclear neutrophiles		
Conclusion:		

1. Characterize anemia by basic criteria.
2. Point out a possible development cause of this pathology.
3. Characterize the state of bone marrow in this patient.

№ 9

Patient G., 19 years, was admitted to clinic for examination. Since childhood a decrease of hemoglobin up to 80–85 g/l was noted. She took preparations of iron, however the treatment proved to be ineffective.

Blood test on admission:

Erythrocytes	3.78×10 ¹² /l	
Hemoglobin	80 g/l	
Color factor	calculate	
Reticulocytes	16 %	
Leukocytes	8.6×10 ⁹ /l	
basophiles	0 %	
eosinophiles	3 %	
neutrophiles:		
– young	0 %	
– rod nuclear	4 %	
– segmentated	59 %	
lymphocytes	29 %	
monocytes	5 %	
Thrombocytes	210×10 ⁹ /l	
In the smear: anisocytosis, poikilocytosis, target-like erythrocytes, erythrocytes with basophile granulation. The level of serum iron — 30 micromol/l		
Conclusion:		

1. What pathology of the circulation system is presented on the given hemogram?
2. What does the peripheral reticulosis testify to?
3. Characterize anemia by basic criteria.

№ 10

Sasha S., 4.5 years. Often falls ill with simple colds. According to his mother after taking of bisepitol, acetylsalicylic acid and doxicyclin the child develops a yellow coloring of the skin and sclera, dark color of urine that gradually disappear after discontinuation of the medicine.

Blood test on admission:

Erythrocytes	$3.0 \times 10^{12}/l$	
Hemoglobin	70 g/l	
Color factor	calculate	
Reticulocytes	10 %	
Leukocytes	$76.6 \times 10^9/l$	
basophiles	0 %	
eosinophiles	3 %	
neutrophiles:		
– young	0 %	
– rod nuclear	2 %	
– segmentated	33 %	
lymphocytes	55 %	
monocytes	7 %	
Thrombocytes	$280 \times 10^9/l$	
In the smear: marked anisocytosis and poikilocytosis, polychromatophylia. The activity of erythrocyte gluycose-6-phosphatedehydrogenase — 2.3 units (in norm — 5.4 ± 0.3 unit).		
Conclusion:		

1. What is the circulation system pathology in the child?
2. What is the incidence mechanism of this pathology?
3. Characterize anemia by basic criteria.

№ 11

Vitya Ch., 3.5 years. Three months ago he suffered a bronchial pneumonia. He was treated out-patiently. However after the disease he became inert, sleepy, gets tired quickly. Often a moderate jaundice of the skin and mucous membranes is noted.

Blood test on admission:

Erythrocytes	$3.3 \times 10^{12}/l$	
Hemoglobin	99 g/l	
Color factor	calculate	
Reticulocytes	19 %	
Leukocytes	$8.2 \times 10^9/l$	
basophiles	0 %	
eosinophiles	4 %	
neutrophiles:		
– young	0 %	
– rod nuclear	4 %	
– segmentated	37 %	
lymphocytes	49 %	
monocytes	6 %	
Thrombocytes	$290 \times 10^9/l$	
In the smear: macrocytes, moderate count of microcytes, erythrocytes of irregular shape (schistocytes).		
The content of indirect bilirubin — 41.6 micromol/l		
Conclusion:		

1. What are the changes of the peripheral blood in the child?
2. Of what pathology are these changes characteristic?
3. Characterize anemia by basic criteria.

№ 12

Patient C., 27 years, a roentgenologist by specialty. Was admitted to clinic with suspicion for an acute leucosis. For a month before the admission she had developed an increasing weakness and elevated bleediness.

Blood test on admission:

Erythrocytes	$1.46 \times 10^{12}/l$	
Hemoglobin	42 g/l	
Color factor	calculate	
Reticulocytes	0.05 %	
Leukocytes	$1.2 \times 10^9/l$	
basophiles	0 %	
eosinophiles	1 %	
neutrophiles:		
– young	0 %	
– rod nuclear	2 %	
– segmentated	18 %	
lymphocytes	68 %	
monocytes	11 %	
Thrombocytes	$37 \times 10^9/l$	
Conclusion:		

1. What are the peripheral blood changes in the patient?
2. Of what pathology are the revealed changes characteristic?
3. Characterize anemia by basic criteria.

№ 13

Kostya N., 4.5 years. His parents complain that the child has been pale since his birth, has a permanently reduced appetite, low mobility, frequent respiratory and infectious diseases, is reserved, his physical development is retarded.

Blood test on admission:

Erythrocytes	$1.66 \times 10^{12}/l$	
Hemoglobin	55 g/l	
Color factor	calculate	
Reticulocytes	0.1 %	
Leukocytes	$2.8 \times 10^9/l$	
basophiles	0 %	
eosinophiles	0 %	
neutrophiles:		
– young	0 %	
– rod nuclear	1 %	
– segmentated	21 %	
lymphocytes	72 %	
monocytes	6 %	
Thrombocytes	$80 \times 10^9/l$	
In the smear: anisocytosis with tendency to macrocytosis, moderately marked poikilocytosis.		
Conclusion:		

1. What pathology of the circulation system is revealed by this hemogram?
2. Can the revealed pathology have a hereditary nature?
3. Characterize the changes of the blood pattern in the given pathology.

№ 14

The total blood test of patient M., 37 years, with chronic respiratory insufficiency revealed:

Blood test on admission:

Erythrocytes	$6.4 \times 10^{12}/l$	
Hemoglobin	180 g/l	
Color factor	calculate	
Reticulocytes	3.4 %	
Leukocytes	$7.2 \times 10^9/l$	
basophiles	0.5 %	
eosinophiles	2 %	
neutrophiles:		
– young	0 %	
– rod nuclear	6 %	
– segmentated	62 %	
lymphocytes	25 %	
monocytes	4.5 %	
Thrombocytes	$200 \times 10^9/l$	
In the smear: slight anisocytosis.		
Conclusion:		

1. Define the character of the peripheral blood changes in this case.
2. What is the pathogenesis of these changes?

№ 15

Patient T., 54 years, complains of frequent headaches due to elevated arterial blood pressure during the last 6–8 months. He is followed-up for arterial hypertension. On filling in the sanatorium card the laboratory examination of the blood revealed:

Blood test on admission:

Erythrocytes	$7.1 \times 10^{12}/l$	
Hemoglobin	178 g/l	
Color factor	calculate	
Reticulocytes	4.8 %	
Leukocytes	$15.6 \times 10^9/l$	
basophiles	1 %	
eosinophiles	6 %	
neutrophiles:		
– young	2 %	
– rod nuclear	11 %	
– segmentated	62 %	
lymphocytes	14 %	
monocytes	4 %	
Thrombocytes	$490 \times 10^9/l$	
Saturation of arterial blood with oxygen is 96 %.		
Conclusion:		

1. What blood circulation pathology characterizes similar changes?
2. Why was the investigation of blood oxygen saturation made for this patient?
3. What is a probable cause of the arterial pressure elevation in this case?

№ 16

Patient R., 7 years was admitted to clinic with complaints of general malaise, reduced appetite, losing weight, indefinite dull pains in the abdomen, irregular stool, rash in the hip area accompanied by itching.

Blood test on admission:

Erythrocytes	$4.4 \times 10^{12}/l$	
Hemoglobin	128 g/l	
Color factor	calculate	
Leukocytes	$13.6 \times 10^9/l$	
basophiles	1 %	
eosinophiles	8 %	
neutrophiles:		
– young	0 %	
– rod nuclear	4 %	
– segmentated	58 %	
lymphocytes	23 %	
monocytes	6 %	
Thrombocytes	$210 \times 10^9/l$	
Conclusion:		

1. What are the peripheral blood changes in the child?
2. What pathologic changes are characterized by similar changes?

№ 17

Patient D., 9 years, is admitted to clinic for examination. For the last year he has been suffering from frequent common colds, pneumonias. Is treated mainly with sulphanylamide preparations, infrequently — with antibiotics.

Blood test on admission:

Erythrocytes	$4.3 \times 10^{12}/l$	
Hemoglobin	130 g/l	
Color factor	calculate	
Leukocytes	$3.0 \times 10^9/l$	
basophiles	0 %	
eosinophiles	2 %	
neutrophiles:		
– young	0 %	
– rod nuclear	0 %	
– segmentated	27 %	
lymphocytes	60 %	
monocytes	11 %	
Thrombocytes	$260 \times 10^9/l$	
Anti-leukocyte bodies are revealed in the serum.		
Conclusion:		

1. The suppression of what hemopoietic germ occurs in this place?
2. What is a possible development mechanism of the revealed changes?
3. What is a suggested cause of pain on swallowing?

№ 18

Patient G., 37 years, is transferred to the surgical department for operative treatment of tuberculosis of the coxofemoral joint.

Blood test on admission:

Erythrocytes	$4.3 \times 10^{12}/l$	
Hemoglobin	125 g/l	
Color factor	calculate	
Leukocytes	$47 \times 10^9/l$	
basophiles	0 %	
eosinophiles	0 %	
neutrophiles:		
– myelocytes	0 %	
– young	3 %	
– rod nuclear	8 %	
– segmentated	27 %	
lymphocytes	52 %	
monocytes	10 %	
Thrombocytes	$210 \times 10^9/l$	
In the smear: single lymphoblasts, marked toxic granulation in the neutrophile cytoplasm.		
Conclusion:		

1. Of what pathology are the present changes in the peripheral blood characteristic?
2. What is the nature of the revealed changes of the blood cellular content?

№ 19

Patient C., 38 years, was admitted to the in-patient department in a severe septic state that developed after a tooth removal.

Blood test on admission:

Erythrocytes	$4.1 \times 10^{12}/l$	
Hemoglobin	129 g/l	
Reticulocytes	0.9 %	
Color factor	calculate	
Leukocytes	$36 \times 10^9/l$	
basophiles	1 %	
eosinophiles	0 %	
neutrophiles:		
– promyelocytes	2 %	
– myelocytes	4 %	
– young	10 %	
– rod nuclear	15 %	
– segmentated	51 %	
lymphocytes	15 %	
monocytes	2 %	
Thrombocytes	$280 \times 10^9/l$	
In the smear: single myeloblasts, toxic granulation in the neutrophile cytoplasm.		
Conclusion:		

1. To what pathology of the circulation system does this pathology testify?
2. What is the pathogenesis of the revealed changes in the patient's blood?

№ 20

Patient B., 16 years, a 9th form schoolboy, was admitted to the adolescents' department for investigation with complaints of pains in the throat on swallowing, bleeding of the gums, fever and chills.

Within a month before the admission he had noted malaise, early fatigue; 1.5 weeks ago he developed pains in the throat on swallowing, the temperature elevated up to 38.5–39 °C, chills. The blood test revealed leukocytosis with «lymphocytosis», the patient was hospitalized.

On admission: the skin integuments and visible mucous membranes are pale. There are hemorrhagic eruptions on the skin of the trunk, mucous membrane of the mouth and soft palate, necrotic coating on the tonsils, the signs of gingivitis. Cervical and sub-clavicular lymphatic nodes of a bean in size are palpated, they are not fused with the surrounding tissues and the skin, are not painful. No changes on the part of the heart and lungs are revealed. The liver extends 2 cm from the edge of the costal arch, is dense on palpation, slightly tender. The spleen is not palpated, length is 13 cm.

Blood test on admission:

Erythrocytes	2.5×10 ¹² /l	
Hemoglobin	78 g/l	
Color factor	calculate	
Leukocytes	220×10 ⁹ /l	
basophiles	0 %	
eosinophiles	0 %	
blast cells	95.5 %	
neutrophiles:		
– rod nuclear	1 %	
– segmentated	0.5 %	
lymphocytes	3 %	
Thrombocytes	45×10 ⁹ /l	
ESR	60 mm/h	
Cytochemic data: blast cells possess a high myeloperoxidase activity, reaction to acid phosphatase «+»; glycosaminoglycans «-».		
Conclusion:		

1. What disease can be suggested?
2. What syndromes appear in the patient?

№ 21

Patient E., 15 years, a school-girl, was admitted to the adolescents' department with complaints of severe headaches, pains in pelvic bones, general weakness, noise in the ears, elevated temperature.

The patient considers herself to be ill for 2 months, since the moment of developing the above symptoms.

Objectively on admission: the skin integuments and visible mucous membranes are pale, petechiae and small bruises are marked, the tonsils are enlarged. Lymphatic nodes are enlarged and well palpated. No changes on the part of the heart and lungs are revealed. The liver near the edge of the costal arch is slightly tender on palpation. The spleen is enlarged, tender. Objectively on admission: the state of a moderate severity. Sharp tenderness on tapping of pelvic bones, ribs, the breastbone. The body temperature is 37.5–38 °C.

Blood test on admission:

Erythrocytes	2.8×10 ¹² /l	
Hemoglobin	85 g/l	
Reticulocytes	1.8 %	
Color factor	calculate	
Leukocytes	20×10 ⁹ /l	
basophiles	0 %	
eosinophiles	0 %	
neutrophiles:		
– myelocytes	0 %	
– young	0 %	
– rod nuclear	3 %	
– segmentated	8 %	
lymphocytes	19.5 %	

monocytes	2 %	
blast cells	67.5 %	
Thrombocytes	$30 \times 10^9/l$	
ESR	52 mm/h	
Blast cells of a medium size, regular shape with a high nuclear-cytoplasmatic ratio, no granulation in the cytoplasm. Cytochemical data: myeloperoxidase activity is absent, the activity of acid phosphatase and non-specific esterase is not high, intensive positive Schiff (PAS) reaction (as large rare granules).		
Conclusion:		

1. What form of the disease can be suggested?
2. What syndromes are revealed in this patient?

№ 22

Patient D., 50 years, a photographer, was admitted to the therapeutic department with complaints of the enlargement of cervical lymphatic glands that has become noted within the last month.

Objectively: the skin integuments have a usual color. Enlarged cervical and sub-lingual nodes to the size of a bean and a hazel nut are palpated, have the consistency of elastic dough, are movable, not fused in between and with the surrounding tissues, are not tender. On the part of thoracic organs no changes are revealed. The liver is not enlarged. The lower border of the spleen is well palpated (length is 16 cm).

Blood test on admission:

Erythrocytes	$3.3 \times 10^{12}/l$	
Hemoglobin	93 g/l	
Color factor	calculate	
Leukocytes	$73 \times 10^9/l$	
basophiles	0.5 %	
eosinophiles	0 %	
neutrophiles:		
– rod nuclear	1 %	
– segmentated	24.5 %	
lymphocytes	72 %	
Thrombocytes	$120 \times 10^9/l$	
ESR	37 mm/h	
Among lymphocytes of the peripheral blood small narrow cytoplasmatic forms (almost bare nuclei) prevail, cells (shadows) of Botkin-Humboldt are revealed in great number. Prolymphocytes comprise 1.5 %. Single lymphoblasts.		
Conclusion:		

1. What disease can be suggested in this case?

№ 23

Patient L., 56 years, an engineer, was admitted to the therapeutic department with complaints of a headache, dizziness, skin itching, bleeding of the gums, pains in the legs.

2–3 years ago he started to note early fatigue, decrease of workability and heaviness in the head. The state considerably aggravated during the last 6 months, when he developed migraine-like headaches, itching increasing after taking a bath, bleeding of the gums, attacks of pain in the toes.

Objectively: integuments with a red-cyanotic shade particularly marked on the face and palms. The symptom of Cooperman (cyanosis of the soft palate and a pale color of the hard palate). There is a hyperemied spot on the skin of the left leg (residual phenomena of a hemorrhagic edema). Peripheral lymphatic nodes are not enlarged. On the part of the lungs and heart — no peculiarities. The liver is at the edge of the costal arch, the spleen extends 1 cm from the hypochondrium, is dense, tenderless.

Blood test on admission:

Erythrocytes	$6.56 \times 10^{12}/l$	
Hemoglobin	178 g/l	
Color factor	calculate	
Reticulocytes	3 %	
HTC	56 %	
Leukocytes	$15.3 \times 10^9/l$	
basophiles	1 %	
eosinophiles	4.5 %	
neutrophiles:		
– young	5 %	
– rod nuclear	10.5 %	
– segmentated	55 %	
lymphocytes	20.5 %	
monocytes	3.5 %	
Thrombocytes	$500 \times 10^9/l$	
ESR	1 mm/h	
Conclusion:		

1. What is the disease and what pathology of the circulation system occurs in this case?

№ 24

Patient M., 27 years, an electrician, was admitted to the therapeutic department with complaints of early fatigue, malaise, heaviness in the left hypochondrium, particularly after meals.

A year ago a random blood test revealed a neutrophile leukocytosis with a shift to the left, any clinical manifestations of a disease being absent. During the last month he was disturbed by weakness, early fatigue, heaviness in the left hypochondrium. After the blood test was made, he was hospitalized.

Objectively on admission: the skin integuments are of a usual color, peripheral lymphatic nodes are not palpated. On the part of thoracic organs no

changes are revealed. The liver at the edge of the costal arch is tenderless. The spleen extends 5 cm from the hypochondrium, is lightly tender on palpation. The body temperature is 37–37.2 °C.

Blood test on admission:

Erythrocytes	$3.8 \times 10^{12}/l$	
Hemoglobin	116 g/l	
Color factor	calculate	
Leukocytes	$125 \times 10^9/l$	
basophiles	6.5 %	
eosinophiles	10 %	
myeloblasts	1 %	
promyelocytes	1 %	
neutrophiles:		
– myelocytes	21 %	
– young	20 %	
– rod nuclear	15.5 %	
– segmentated	14.5 %	
lymphocytes	7.5 %	
monocytes	3 %	
Thrombocytes	$485 \times 10^9/l$	
ESR	21 mm/h	
On cytogenic examination of the bone marrow punctuate a Phyladelphic chromosome was revealed in 98 % of metaphases		
Conclusion:		

1. What disease of the circulation system is meant here?

№ 25

Patient G., 34 years, applied to the doctor with complaints of general weakness, early fatigue, sweating, heaviness in the left hypochondrium.

Blood test on admission:

Erythrocytes	$3.1 \times 10^{12}/l$	
Hemoglobin	88 g/l	
Color factor	calculate	
Leukocytes	$93 \times 10^9/l$	
basophiles	9 %	
eosinophiles	4 %	
myeloblasts	1 %	
promyelocytes	6 %	
neutrophiles:		
– myelocytes	20 %	
– young	20 %	
– rod nuclear	13 %	
– segmentated	12 %	
lymphocytes	10 %	
monocytes	5 %	
Thrombocytes	$390 \times 10^9/l$	
Conclusion:		

1. What changes in the leukocyte formula are there in the patient and what impairment of leucopoiesis do they testify to?
2. What is a suggested diagnosis?
3. What kind of anemia takes place in this case?

HEMOSTASIS IMPAIRMENT

№ 26

Patient A., 17 years, suffers from a profuse menstrual bleeding. She is predisposed to having bruises on the slightest injuries, nose bleedings since early childhood. Hematomas appeared at the sites of intramuscular injections. When she was 8, after falling down, she got a hematoma in the back area. Her grandfather on the father's line suffered from bleedings, died at 40 years from a gastric bleeding. The patient's father also often has nose bleedings.

Investigation results of the hemostasis system:

- cuff test — 12–15 petechiae;
- thrombocyte blood count — $160 \times 10^9/l$;
- test for thrombocyte adhesion to the glass comprised 8 %;
- thrombocyte aggregation induced by ristocetine is decreased;
- bleeding time (BT) — 22 min;
- activated partial thromboplastin time (APTPT) — 108 sec;
- prothrombin time (PT) — 13 sec;
- concentration of Willebrandt factor and its activity are decreased.

Questions:

1. Using the objective investigation data of patient's A. anamnesis name the type of bleeding.
2. Evaluate the factors reflecting the vascular-thrombocyte hemostasis.
3. Evaluate the factors reflecting a coagulatory homeostasis.
4. Define etiopathogenesis of this disease.
5. What disease does patient A. suffer from? Ground your answer.

№ 27

Patient C., 32 years, suffering from a systemic lupus erythematosus, referred with complaints for appearing of bruises on the trunk and extremities, frequent nose, gum and uterine bleedings. Objectively: petechial-purple rash is marked on the skin of the trunk and extremities; the spleen is slightly enlarged. The blood test revealed: erythrocytes — $3.0 \times 10^{12}/l$, Hb — 100 g/l, neutropenia, eosinophilia, the thrombocyte count — $30 \times 10^9/l$, the level of IgG is elevated. The half-life period of thrombocytes — 18 h. APTPT (activated partial thromboplastin time) — 30 sec., PT (prothrombin time) — 14 sec., BT (bleeding time) — 22 min.

Questions:

1. Name the type of the hemostasis impairment in patient C.
2. To what classification group of hemostasis impairments can it be referred?
3. What hemostasis mechanism is broken in patient C.? Name the cause, pathogenetic factors, clinical syndromes accompanying the given form of hemostasis pathology. Prove your answer, taking into account the laboratory diagnostic data.
4. Name the treatment principles of the given hemostasis impairment.

№ 28

Parents applied to the doctor for frequent nose and gum bleedings, and also periodic hemorrhages into the child's skin.

Objectively: there are petechial eruptions, small bruises on the skin of the trunk and extremities. The family anamnesis revealed, that cases of similar bleeding were observed in the families of both parents.

Thrombocyte count in the blood — $180 \times 10^9/l$. Thrombocyte adhesiveness — 45 %. Investigation of thrombocyte aggregation on addition of ristocetine, an aggregation inductor, revealed the absence of a characteristic two-wave curve. APTT — 36 sec., PT — 12.5 sec., BT — 25 minutes.

Questions:

1. Name the type of the hemostasis impairment in the child.
2. What hemostasis mechanism is broken? Prove the answer, using the anamnesis, the data of the objective examination and laboratory diagnostics.
3. Characterize the parameters reflecting the thrombocyte function in the given patient.
4. Name the cause and pathogenetic parts of the given hemostasis pathology.

№ 29

The parents of a 10-year boy applied to the doctor. Since the age of 6-years they started to notice the appearance of irregular-shaped spots that bled on slight mechanical actions, in the area of nose wings, mucous membrane of the oral cavity, hairy parts of the head. The child also spontaneously and periodically developed persistent, stopped with difficulty, recurrent nose bleedings. During common colds, on the background of taking fever relieving preparations, there occurred vomiting of a "coffee grounds» color with some blood impurity and a tarry stool. On endoscopic examination of the mucous membrane of the stomach and duodenum a great number of bright-red spots of irregular shape were revealed.

The child's father suffers from nose bleedings, the elements in the form of vascular bundles are revealed on the hairy part of his head.

The blood test of the child revealed hypochromous anemia, reticulocytosis, thrombocytosis. Investigation of the hemostasis revealed some hypercoagulation. BT — 22 minutes.

Questions:

1. What disease is revealed in the 7-year old boy? To what group of hemostasis impairments is it referred?
2. What is the development cause of the given disease?
3. Explain its pathogenesis.
4. Explain the incidence causes of this kind of hematological impairments in this patient?
5. What are the treatment principles of the given disease?

№ 30

The child of 5 years, who had suffered a virus infection, developed pains in knee joints, then — symmetric papular-hemorrhagic rash on lower extremities, the temperature elevated up to 38 °C. Some days later the child began to complain of colicky pains in the stomach, a more frequent stool, bloody vomiting. Blood was revealed in feces too.

The blood test revealed: leukocytosis, normochromous anemia, reticulocytosis, elevated ESR. The thrombocyte count in blood is increased. Laboratory examination allowed to reveal an increase of the level of circulating immune complexes (CIC), hyperfibrinogenemia, decrease of the content of AT III (anti-thrombin III). BT — 15 minutes.

Questions:

1. To what group of hemostasis impairments can it be referred to?
2. What is the name of this nosologic form?
3. Name the etiologic factors and pathogenetic mechanisms of its development.
4. What syndromes appear in the patient?
5. Characterize the presented data of the laboratory examination.
6. List the treatment principles of the given disease.

№ 31

Patient B., 9 years, suffers from bleeding since early childhood: in infancy, after falling down, an extensive hematoma formed in the back area, there were nose bleedings, hemorrhages in the buttocks area. At the age of 3-years he had a profuse and prolonged bleeding from the site, where the tongue was bit; as a result he was hospitalized and received the proper treatment. Since the 4th year recurrent painful hemorrhages into talocrural and knee joints were observed. The joints are edematous, deformed. The data of the laboratory examination: APTPT is 120 sec., PT — 13.5 sec., BT — 8.5 minutes.

Questions:

1. What group of hemostasis impairments may be suggested in such a clinical picture. What other investigations are still required for making an exact diagnosis?
2. Characterize the presented data of laboratory examinations. To what impairment mechanism of hemostasis do they testify?
3. Name the treatment principles of the given hemostasis pathology.

№ 32

In patient I., 3 years, the temperature elevated up to 39 °C, a bloody diarrhea appeared. A day later oliguria with proteinuria, asotemia, petechial intradermal hemorrhages developed. Bloody vomiting, nose bleedings appeared. Examination of feces allowed to establish the presence of *Shigella dysenteriae*.

In blood: erythrocytes — $2 \times 10^{12}/\mu\text{l}$, Hb — 30 g/l, ESR — 15 mm per h, reticulocytes — 2 %, L — $1.8 \times 10^9/l$, thrombocytes — $23 \times 10^9/l$. BT — 13 min, APTPT — 38 s, PT — 14 s.

Questions:

1. Name the type of hemostasis impairment.
2. What hemostasis mechanism is broken? Prove the answer, using the data of the anamnesis and laboratory diagnostics.
3. Characterize the incidence causes of its pathology, pathogenesis links.
4. What therapeutic measures will be effective in the given hemostasis impairment?

№ 33

Patient E., 27 years, was admitted to clinic due to chills, fever up to 40 °C, complaints of bloody discharge from the uterus, bruises on sites of injections, profuse nose and gum bleedings. The doctors have suspected a criminal abortion, that was further confirmed by a gynecologic examination, and, as a consequence — sepsis.

The blood test revealed: anemia, leukocytosis and a hyperregenerative shift of the leukocyte formula to the left, toxic granularity of leukocytes, thrombocytes — $21 \times 10^9/\mu\text{l}$, ESR — 45 mm per h, hyperbilirubinemia. *St. aureus* was revealed in the blood and in the uterine cavity on bacteriological examination.

By the end of the first day of staying in hospital the patient developed acute renal insufficiency (oligo-anuria, asotemia, edemas), profuse bloody vomiting was marked.

The data of laboratory examination: APTPT — 115s, content of FV, FVIII, fibrinogen, ATIII (anti-thrombin III) is reduced, the amount of fibrin degradation products is increased.

Questions:

1. What type of hemostasis impairments developed in patient E. on the background of a criminal abortion?
2. What is the main link of pathogenesis in the development of the given pathology?
3. What syndromes are revealed in patient E.?
4. Give a detailed explanation of the changes in laboratory parameters.
5. Name the treatment principles of the given hemostasis impairment.

№ 34

The patient A., 30 years, gestosis of the II second half of pregnancy, in the term of 30 weeks — exfoliation of a normally located placenta. Consequently developed: respiratory insufficiency (breathlessness, cyanosis, tachycardia), sharp decrease of diuresis, proteinuria, cylindrouria.

The first coagulogram examination revealed: APTPT — 22 sec, SCFM — +++++, fibrinogen — 1.6 g/l, D-dimers — 2500 ng/ml, thrombocytes — $120 \times 10^9/l$.

2 hours later after the admission to hospital: a bloody discharge from the uterus persists, bleeding on the sites of injections, nose bleeding.

The second coagulogram examination revealed: APTPT — blood does not stop, SCFM are negative, fibrinogen is not determined, d-dimers — 5000 ng/ml, thrombocytes — $50 \times 10^9/l$, the content of anti-thrombin III is sharply reduced, hyperplasminemia.

Questions:

1. What type of the hemostasis impairment developed in the patient?
2. What syndrome stage is revealed in the first hemostasis investigation?
3. What stage was revealed in the second investigation of hemostasis?
4. What is a pathogenetic characteristic of the levels dynamics of thrombocytes, SCFM, d-dimers?
5. What is the interrelation of hyperplasminemia and the level of SCFM and d-dimers?
6. The treatment principles of the given pathology of hemostasis.

№ 35

The patient of 65 years after the operation of aortocoronary by-passing constantly takes indirect anticoagulant warfarin. Having missed a visit to the doctor, he took at once a 3-fold dose of the preparation. Referred for nose bleedings. The coagulogram data: APTPT — 45 sec.; TV — 20 sec.; PT — 36 sec.; PTI — 0.4; INR — 3.

Questions:

1. What hemostasis impairment can be spoken about according to the anamnesis and coagulogram?

2. Is the therapeutic hypocoagulation excessive in this case?
3. What is its danger?
4. Name the correction principles of the given condition.

№ 36

A coagulogram was examined in the patient L., 45 years, with systemic lupus erythromatous in an active phase to evaluate thrombotic complications. According to investigation: SCFM — +++; APTPT — 33 sec.; fibrinogen — 1.8 g/l (N=1.9-4 g/l); TV — 15 sec. (N=14–16 sec.); d-dimers — 450 ng/ml.

Questions:

1. Estimate, whether there is hypercoagulation in this patient.
2. What is a pathogenetic estimation of a positive test for SCFM?

№ 37

Patient E., 45 years, was operated on for abdominal phlegmonous appendicitis. Has been keeping the bed regimen for 3 days. The coagulogram examination revealed: APTPT — 27 sec.; INR — 1; PTI — 1; fibrinogen — 1.8 g/l; SCFM — +++; d-dimers — 600 ng/l.

Questions:

1. Estimate, if this patient has hypercoagulation.
2. What complications should be avoided?
3. What is the medical tactic?

Hemograms

№ 1

Erythrocytes	$2,7 \times 10^{12}/l$	
Hemoglobin	68 g/l	
Reticulocytes	5 %	
Color factor	calculate	
Leukocytes	$12.0 \times 10^9/l$	
basophiles	0 %	
eosinophiles	2 %	
neutrophiles:		
– myelocytes	0 %	
– young	7 %	
– rod nuclear	17 %	
– segmentated	53 %	
lymphocytes	17 %	
monocytes	4 %	
Thrombocytes	$150.0 \times 10^9/l$	
ESR	18 mm per h	
In the smear: polychromatophiles, single normoblasts.		
Conclusion:		

№ 1a

Erythrocytes	2,7×10 ¹² /l	
Hemoglobin	68 g/l	
Reticulocytes	5.0 %	
HCT	24 %	
Color factor	calculate	
MCV	calculate	
MCH	calculate	
RDW	13.8 %	
Leukocytes	12.0×10 ⁹ /l	
basophiles	0 %	
eosinophiles	2 %	
neutrophiles:		
– myelocytes	0 %	
– young	7 %	
– rod nuclear	17 %	
– segmentated	53 %	
lymphocytes	17 %	
monocytes	4 %	
Thrombocytes	150.0×10 ⁹ /l	
ESR	18 mm per h	
In the smear: polychromatophiles, single normoblasts.		
Conclusion:		

№ 2

Erythrocytes	3.36×10 ¹² /l	
Hemoglobin	67 g/l	
Color factor	calculate	
Leukocytes	5.1×10 ⁹ /l	
basophiles	0 %	
eosinophiles	2 %	
neutrophiles:		
– myelocytes	0 %	
– young	0 %	
– rod nuclear	5 %	
– segmentated	51 %	
lymphocytes	38 %	
monocytes	4 %	
Thrombocytes	180.0×10 ⁹ /l	
ESR	15 mm per h	
In the smear: poikilocytosis, microcytosis.		
Conclusion:		

№ 2a

Erythrocytes	$3.36 \times 10^{12}/l$	
Hemoglobin	67 g/l	
Color factor	calculate	
HCT	22 %	
MCV	calculate	
MCH	calculate	
RDW	16.9 %	
Leukocytes	$5.1 \times 10^9/l$	
basophiles	0 %	
eosinophiles	2 %	
neutrophiles:		
– myelocytes	0 %	
– young	70 %	
– rod nuclear	5 %	
– segmentated	51 %	
lymphocytes	38 %	
monocytes	4 %	
Thrombocytes	$180.0 \times 10^9/l$	
ESR	15 mm per h	
Conclusion:		

№ 3

Erythrocytes	$3.79 \times 10^{12}/l$	
Hemoglobin	83 g/l	
HCT	27.8 %	
MCV	73.3 %	
MCH	21.9 pg/cell	
MCHC	29.9 g/dcl	
RDW	20.8 %	
Leukocytes	$6.4 \times 10^9/l$	
basophiles	1 %	
eosinophiles	3 %	
neutrophiles:		
– myelocytes	0 %	
– young	0 %	
– rod nuclear	4 %	
– segmentated	62 %	
lymphocytes	20 %	
monocytes	10 %	
Thrombocytes	$415.0 \times 10^9/l$	
ESR	12 mm per h	
Blood serum iron — 6,85 micromol/l.		
Conclusion:		

№ 4

Erythrocytes	$3.5 \times 10^{12}/l$	
Hemoglobin	72 g/l	
HCT	25 %	
MCV	calculate	
MCH	calculate	
RDW	15.5 %	
Leukocytes	$3.6 \times 10^9/l$	
basophiles	0 %	
eosinophiles	3 %	
neutrophiles:		
– myelocytes	0 %	
– young	0 %	
– rod nuclear	5 %	
– segmentated	64 %	
lymphocytes	23 %	
monocytes	5 %	
Thrombocytes	$180.0 \times 10^9/l$	
ESR	8 mm per h	
Blood serum iron — 6,85 micromol/l.		
Conclusion:		

№ 5

Erythrocytes	$1.58 \times 10^{12}/l$	
Hemoglobin	68 g/l	
Reticulocytes	0 %	
Color factor	calculate	
Leukocytes	$2.8 \times 10^9/l$	
basophiles	0 %	
eosinophiles	0 %	
neutrophiles:		
– myelocytes	0 %	
– young	0 %	
– rod nuclear	1 %	
– segmentated	42 %	
lymphocytes	55 %	
monocytes	2 %	
Thrombocytes	$85.0 \times 10^9/l$	
ESR	28 mm per h	
In the smear: megalocytes, megaloblasts, macrocytosis, anisocytosis, poikilocytosis, erythrocytes with Jolli bodies, Kabo rings, polysegmentated neutrophiles.		
Conclusion:		

№ 5a

Erythrocytes	1.58×10 ¹² /l	
Hemoglobin	68 g/l	
Reticulocytes	0 %	
HCT	18 %	
Color factor	calculate	
MCV	calculate	
MCH	calculate	
RDW	18.7 %	
Leukocytes	2.8×10 ⁹ /l	
Basophiles	0 %	
eosinophiles	0 %	
neutrophiles:		
– myelocytes	0 %	
– young	0 %	
– rod nuclear	1 %	
– segmentated	42 %	
lymphocytes	55 %	
monocytes	2 %	
Thrombocytes	85.0×10 ⁹ /l	
ESR 28 mm per h. In the smear: megalocytes, megaloblasts, erythrocytes with Jolli bodies, Kabo rings, polysegmentated neutrophiles.		
Conclusion:		

№ 6

Erythrocytes	2.58×10 ¹² /l	
Hemoglobin	86 g/l	
Reticulocytes	0.05 %	
Color factor	calculate	
Leukocytes	3.4×10 ⁹ /l	
basophiles	1 %	
eosinophiles	2 %	
neutrophiles:		
– myelocytes	0 %	
– young	0 %	
– rod nuclear	2 %	
– segmentated	52 %	
lymphocytes	41 %	
monocytes	2 %	
Thrombocytes	142.0×10 ⁹ /l	
ESR	29 mm per h	
In мазке: anisocytosis, poikilocytosis, toxic granularity of neutrophiles.		
Conclusion:		

№ 7

Erythrocytes	$2.9 \times 10^{12}/l$	
Hemoglobin	110 g/l	
Color factor	calculate	
Reticulocytes	35 %	
Leukocytes	$6.1 \times 10^9/l$	
basophiles	0 %	
eosinophiles	0 %	
neutrophiles:		
– myelocytes	0 %	
– young	0 %	
– rod nuclear	3 %	
– segmentated	60 %	
lymphocytes	32 %	
monocytes	5 %	
Thrombocytes	$200.0 \times 10^9/l$	
ESR is 19 mm per h. In the smear: microspherocytosis of erythrocytes, osmotic resistance of erythrocytes is decreased.		
Conclusion:		

№ 8

Erythrocytes	$3.32 \times 10^{12}/l$	
Hemoglobin	72 g/l	
Color factor	calculate	
Reticulocytes	10 %	
Leukocytes	$4.4 \times 10^9/l$	
basophiles	0.5 %	
eosinophiles	2 %	
neutrophiles:		
– myelocytes	0 %	
– young	0 %	
– rod nuclear	3 %	
– segmentated	54.5 %	
lymphocytes	35 %	
monocytes	5 %	
Thrombocytes	$180.0 \times 10^9/l$	
ESR is 20 mm per h. In the smear: anisocytosis, poikilocytosis, basophil punctuation of erythrocytes, target-like erythrocytes, microcytosis. Blood serum iron — 64 mcmol/l. Osmotic resistance of erythrocytes is increased.		
The presumable conclusion :		
What additional examination is necessary for making the diagnosis more precise?		

№ 9

Erythrocytes	$1.9 \times 10^{12}/l$	
Hemoglobin	45 g/l	
Color factor	calculate	
Reticulocytes	12 %	
Leukocytes	$7.8 \times 10^9/l$	
basophiles	0.5 %	
eosinophiles	1.5 %	
neutrophiles:		
– myelocytes	0 %	
– young	0 %	
– rod nuclear	4 %	
– segmentated	60 %	
lymphocytes	28 %	
monocytes	6 %	
Thrombocytes	$350.0 \times 10^9/l$	
ESR is 1 mm per h. In the smear: crescent erythrocytes, meniscocytes.		
The conclusion:		

№ 10

Erythrocytes	$7.32 \times 10^{12}/l$	
Hemoglobin	170 g/l	
HCT	57 %	
Color factor	calculate	
Reticulocytes	3 %	
Leukocytes	$16.4 \times 10^9/l$	
basophiles	0.5 %	
eosinophiles	7.5 %	
neutrophiles:		
– myelocytes	0 %	
– young	3 %	
– rod nuclear	10 %	
– segmentated	59 %	
lymphocytes	17 %	
monocytes	53 %	
Thrombocytes	$628.0 \times 10^9/l$	
ESR is 1 mm per h. In the smear: polychromatophiles, single normoblasts.		
Conclusion:		

№ 11

Erythrocytes	$6.6 \times 10^{12}/l$	
Hemoglobin	174 g/l	
Color factor	calculate	
Reticulocytes	5 %	
Leukocytes	$8.7 \times 10^9/l$	
basophiles	0 %	
eosinophiles	1 %	
neutrophiles:		
– myelocytes	0 %	
– young	1 %	
– rod nuclear	5 %	
– segmentated	65 %	
lymphocytes	24 %	
monocytes	54 %	
Thrombocytes	$280.0 \times 10^9/l$	
ESR	8 mm per h	
Conclusion:		

№ 12

Erythrocytes	$4.3 \times 10^{12}/l$	
Hemoglobin	120 g/l	
Color factor	calculate	
Leukocytes	$11.8 \times 10^9/l$	
basophiles	0 %	
eosinophiles	5 %	
neutrophiles:		
– myelocytes	0 %	
– young	2 %	
– rod nuclear	7 %	
– segmentated	63 %	
lymphocytes	19 %	
monocytes	5 %	
Thrombocytes	$200.0 \times 10^9/l$	
ESR	17 mm per h	
Conclusion:		

№ 13

Erythrocytes	$4.2 \times 10^{12}/l$	
Hemoglobin	125 g/l	
Color factor	calculate	
Leukocytes	$17.4 \times 10^9/l$	
basophiles	0 %	
eosinophiles	0.5 %	
neutrophiles:		
– myelocytes	0 %	
– young	5 %	
– rod nuclear	12 %	
– segmentated	64 %	
lymphocytes	14 %	
monocytes	4.5 %	
Thrombocytes	$290.0 \times 10^9/l$	
ESR	25 mm per h	
Conclusion:		

№ 14

Erythrocytes	$3.22 \times 10^{12}/l$	
Hemoglobin	75 g/l	
Color factor	calculate	
Leukocytes	$30.0 \times 10^9/l$	
basophiles	0 %	
eosinophiles	0 %	
neutrophiles:		
– myelocytes	6 %	
– young	17 %	
– rod nuclear	30 %	
– segmentated	42 %	
lymphocytes	4 %	
monocytes	1 %	
Thrombocytes	$220.0 \times 10^9/l$	
ESR	45 mm per h	
In the smear: toxic granularity of neutrophiles.		
Conclusion:		

№ 15

Erythrocytes	$3.8 \times 10^{12}/l$	
Hemoglobin	116 g/l	
Color factor	calculate	
Leukocytes	$14.8 \times 10^9/l$	
basophiles	0 %	
eosinophiles	2 %	
neutrophiles:		
– myelocytes	0 %	
– young	0 %	
– rod nuclear	5 %	
– segmentated	21 %	
lymphocytes	60 %	
monocytes	12 %	
Thrombocytes	$185.0 \times 10^9/l$	
ESR	17 mm per h	
Conclusion:		

№ 16

Erythrocytes	$4.4 \times 10^{12}/l$	
Hemoglobin	130 g/l	
Color factor	calculate	
Leukocytes	$8.8 \times 10^9/l$	
basophiles	1 %	
eosinophiles	11 %	
neutrophiles:		
– myelocytes	0 %	
– young	0 %	
– rod nuclear	5 %	
– segmentated	54 %	
lymphocytes	24 %	
monocytes	5 %	
Thrombocytes	$200.0 \times 10^9/l$	
ESR	10 mm per h	
Conclusion:		

№ 17

Erythrocytes	4.28×10 ¹² /l	
Hemoglobin	142 g/l	
Color factor	calculate	
Leukocytes	3.2×10 ⁹ /l	
eosinophiles	1 %	
basophiles	0 %	
neutrophiles:		
– myelocytes	0 %	
– young	0 %	
– rod nuclear	12 %	
– segmentated	23 %	
lymphocytes	57 %	
monocytes	7 %	
Thrombocytes	285.0×10 ⁹ /l	
ESR is 18 mm per h.		
Patient B., 28 years with high temperature.		
Conclusion:		

№ 18

Erythrocytes	2.96×10 ¹² /l	
Hemoglobin	97 g/l	
Color factor	calculate	
Leukocytes	1.0×10 ⁹ /l	
basophiles	0 %	
eosinophiles	0 %	
neutrophiles:		
– myelocytes	0 %	
– young	0 %	
– rod nuclear	0 %	
– segmentated	15 %	
lymphocytes	68 %	
monocytes	17 %	
Thrombocytes	85.0×10 ⁹ /l	
ESR	49 mm per h	
In the smear: toxic granularity of neutrophiles. Note: quinsy with necrotic coating.		
Conclusion:		

№ 19

Erythrocytes	$3.84 \times 10^{12}/l$	
Hemoglobin	120 g/l	
Color factor	calculate	
Leukocytes	$1.0 \times 10^9/l$	
basophiles	0 %	
eosinophiles	0.5 %	
neutrophiles:	0 %	
– lymphocytes	82 %	
– monocytes	17.5 %	
Thrombocytes	$182.0 \times 10^9/l$	
ESR	17 mm per h	
Conclusion:		

№ 20

Erythrocytes	$0.56 \times 10^{12}/l$	
Hemoglobin	17 g/l	
Color factor	calculate	
Leukocytes	$0.9 \times 10^9/l$	
basophiles	0 %	
eosinophiles	0 %	
neutrophiles:		
– myelocytes	0 %	
– young	0 %	
– rod nuclear	0 %	
– segmentated	12 %	
lymphocytes	86 %	
monocytes	2 %	
Thrombocytes	$25.0 \times 10^9/l$	
ESR — 40 mm per h. In the smear: anisocytosis, poikilocytosis, toxic granularity of neutrophiles.		
Conclusion:		

№ 21

Erythrocytes Hemoglobin Color factor Leukocytes eosinophiles basophiles neutrophiles: – myelocytes – young – rod nuclear – segmentated lymphocytes («lymphomonocytes») monocytes Thrombocytes	4.36×10 ¹² /l 118 g/l calculate 18.2×10 ⁹ /l 3 % 0 % 0 % 1 % 5 % 10 % 67 % 13 % 350.0×10 ⁹ /l	
Single lymphoblasts in the field of vision. Plasmatic cells — 4 per 100 leukocytes. Toxic granularity of neutrophiles.		
Conclusion:		

№ 22

Erythrocytes Hemoglobin Color factor Leukocytes basophiles eosinophiles Myeloblasts promyelocytes neutrophiles: – myelocytes – young – rod nuclear – segmentated lymphocytes monocytes Thrombocytes ESR	2.4×10 ¹² /l 75 g/l calculate 3.2×10 ⁹ /l 0 % 0 % 30 % 1 % 0 % 0 % 4 % 30 % 30 % 5 % 75.0×10 ⁹ /l 55 mm per h	
Conclusion:		

№ 23

Erythrocytes	$3.5 \times 10^{12}/l$	
Hemoglobin	110 g/l	
Color factor	calculate	
Leukocytes	$150.0 \times 10^9/l$	
basophiles	6 %	
eosinophiles	7.5 %	
myeloblasts	1 %	
promyelocytes	2 %	
neutrophiles:		
– myelocytes	25 %	
– young	22.5 %	
– rod nuclear	18 %	
– segmentated	14 %	
lymphocytes	3 %	
monocytes	1 %	
Thrombocytes	$522.0 \times 10^9/l$	
ESR	35 mm per h	
Conclusion:		

№ 24

Erythrocytes	$3.2 \times 10^{12}/l$	
Hemoglobin	87 g/l	
Color factor	calculate	
Leukocytes	$38.0 \times 10^9/l$	
basophiles	8 %	
eosinophiles	3 %	
myeloblasts	1 %	
promyelocytes	1 %	
neutrophiles:		
– myelocytes	5 %	
– young	4.5 %	
– rod nuclear	5.5 %	
– segmentated	45 %	
lymphocytes	24 %	
monocytes	3 %	
Thrombocytes	$380.0 \times 10^9/l$	
ESR	35 mm per h	
Conclusion:		

№ 25

Erythrocytes	$2.5 \times 10^{12}/l$	
Hemoglobin	78 g/l	
Color factor	calculate	
Leukocytes	$200.0 \times 10^9/l$	
myeloblasts	97 %	
promyelocytes	0.5 %	
neutrophiles:		
– myelocytes	0 %	
– young	0 %	
– rod nuclear	0 %	
– segmentated	2.5 %	
lymphocytes	0 %	
monocytes	0 %	
Thrombocytes	$48.0 \times 10^9/l$	
ESR	60 mm per h	
Conclusion:		

№ 26

Erythrocytes	$1.1 \times 10^{12}/l$	
Hemoglobin	37 g/l	
Color factor	calculate	
Leukocytes	$8.4 \times 10^9/l$	
Basophiles	0 %	
eosinophiles	0 %	
neutrophiles:		
– myelocytes	0 %	
– young	0 %	
– rod nuclear	2 %	
– segmentated	10 %	
lymphoblasts	62 %	
lymphocytes	20 %	
monocytes	6 %	
Thrombocytes	$28.0 \times 10^9/l$	
ESR	52 mm per h	
Conclusion:		

№ 27

Erythrocytes	$2.8 \times 10^{12}/l$	
Hemoglobin	68 g/l	
Color factor	calculate	
Leukocytes	$300.0 \times 10^9/l$	
basophiles	0 %	
eosinophiles	1 %	
neutrophiles:		
– myelocytes	0 %	
– young	0 %	
– rod nuclear	1 %	
– segmentated	2 %	
Lymphoblasts	1 %	
lymphocytes	94 %	
monocytes	1 %	
Thrombocytes	$87.0 \times 10^9/l$	
ESR	40 mm per h	
In мазке: in a plenty of a cell (shadow) of Botkin–Gumprecht.		
Conclusion:		

№ 28

Erythrocytes	$2.0 \times 10^{12}/l$	
Hemoglobin	64 g/l	
Color factor	calculate	
Leukocytes	$8.4 \times 10^9/l$	
basophiles	0 %	
eosinophiles	0 %	
neutrophiles:		
– segmentated	4.5 %	
– lymphocytes	4 %	
– monocytes	1 %	
– blast cells	90.5 %	
Trompocytes	$32.0 \times 10^9/l$	
Peroxidase reaction is positive		
Conclusion:		

№ 29

Erythrocytes	$2.3 \times 10^{12}/l$	
Hemoglobin	58 g/l	
Color factor	calculate	
Leukocytes	$2.7 \times 10^9/l$	
basophiles	0.5 %	
eosinophiles	0 %	
neutrophiles:		
– myelocytes	0 %	
– young	0 %	
– rod nuclear	1.5 %	
– segmentated	8.5 %	
lymphocytes	7.0 %	
monocytes	4.5 %	
blast cells (cytochemical reactions are negative)	78 %	
Thrombocytes	$522.0 \times 10^9/l$	
Conclusion:		

BLOOD PARAMETERS IN NORM

Parameter name	SI system	Non-systemic units
Erythrocytes (RBC): in women in men	$3.9-4.7 \times 10^{12}/l$ $4.0-5.0 \times 10^{12}/л$	3.9–4.7 million/l micrl 4.0–5.0 million/ 1 micrl
Hemoglobin (HGB): in women in men	120.0–140.0 g/l 130.0–1600 g/l	12.0–14.0 g % 13.0–16.0 g %
Гематокрит (HCT): in women in men	0.36–0.42 0.40–0.48	36–42 % 40–48 %
Mean erythrocyte volume (mean corpuscular volume — MCV) $MCV = HCT : RBC$	80–100 phl ($10^{-15} l$)	80–100 mcm ³
Mean hemoglobin content in an erythrocyte (mean corpuscular hemoglobin — MCH) $MCH = HGB : RBC$	$25.4-34.6 \times 10^{-15} kg/cell$	25.4–34.6 pg/cell*
Mean hemoglobin concentration in an erythrocyte (mean corpuscular hemoglobin concentration — MCHC) $MCHC = HGB : HCT$	0.3–0.38 kg/l	30–38 g/dl * 30–38 %
Distribution width of erythrocytes by the volume (red cell distribution width — RDW) — anisocytosis factor	11.5–14.5 %	1.5–14.5 %
Color factor	0.8–1.0	0.8–1.0
Reticulocytes	0.2–1.0 %	2.0–10.0 %
ESR: in women in men	1–15 mm/hour 1–10 mm/hour	1–15 mm/hour 1–10 mm/hour

* The most common dimension of the parameter.

Calculation of erythrocyte indices:

Mean erythrocyte volume (MCV) is calculated by division of the hematocrit value of 1mm^3 of blood by the erythrocyte count in 1mm^3 by the formula:

$$\text{MCV} = \frac{\text{Hematocrit in } 1 \text{ mm}^3}{\text{Erythrocyte count in } 1 \text{ mm}^3};$$

Normal MCV value — 80–100;

MCV < 79 — microcytosis;

MCV > 100 — macrocytosis;

In practice the mean erythrocyte volume is calculated by multiplication of the hematocrit (%) by 10 and divisions of the received product by the erythrocyte count per 1 l of blood:

$$\text{MCV} = \frac{\text{Hematocrit (\%)} \times 10^{-12}}{\text{Erythrocyte count in } 1\text{l} \times 10^{-12}}.$$

The Mean content of hemoglobin in an erythrocyte (MCH) is established by the formula:

$$\text{MCH} = \frac{\text{Hemoglobin (g/l)}}{\text{Erythrocyte count in } 1\text{l} \times 10^{-12}}.$$

Mean concentration of hemoglobin in an erythrocyte (MCHC):

$$\text{MCHC} = \frac{\text{Hemoglobin (g/100 ml)} \times 100}{\text{Hematocrit (\%)}}.$$

BLOOD PARAMETERS IN NORM (continuation)

Leukocytes	$4.0-9.0 \times 10^9/\text{l}$	4.0–9.0 thousand in 1 mcl
Neutrophiles: rod nuclear	1–6 % $0.040-0.300 \times 10^9/\text{l}$	1–6 % 40–300 in 1 mcl
Segmentated	47–72 % $2.000-5.500 \times 10^9/\text{l}$	47–72 % 2000–5500 in 1 mcl
Eosinophiles	1.0–5 % $0.020-0.300 \times 10^9/\text{l}$	1.0–5 % 20–300 in 1 mcl
Basophiles	0–1 % $0-0.065 \times 10^9/\text{l}$	0–1 % 0–65 in 1 mcl
Lymphocytes	19–37 % $1.200-3.000 \times 10^9/\text{l}$	19–37 % 1200–3000 in 1 mcl
Monocytes	3–11 % $0.09-0.6 \times 10^9/\text{l}$	3–11 % 90–600
Thrombocytes	$150.0-450.0 \times 10^9/\text{l}$	150–450.0 thousand in 1 mcl

**Morphological characteristic of basic types of anemia
with the account of erythrocyte indices**

Anemia type	ЦП	Erythrocyte-diameter, micron	MCV, phl	MCH, pg	RDW, %	Characteristic
Acute post-hemorrhagic	0.8–1.05	7.2–7.5	80–90	27–33	norm	normochromous, normocytic
Fe-deficient	<0.8	<6.5	<79	<27	>14,5	hypochromous, microcytic
B ¹² -deficient	>1.1	>8	>100	>34	>14,5	hyperchromous, macrocytic
Hemolytic	0.8–1.05	<6.5 or norm	<79 or norm	>34 or norm	>14,5	normochromous, normocytic or hyperchromous, microspherocytic
Aplastic	0.8–1.05	7.2–7.5	80–90	27–33	norm	normochromous, normocytic

**SEVERITY CHARACTERISTIC OF ANEMIA
(according to E. D. Goldberg)**

Severity degree	Hemoglobin (g/l)	Erythrocytes × 10 ¹² /l
Light	>100	>3
Moderate	100–66	3–2
Severe	<66	<2

**EXAMINATION METHODS
OF VASCULAR-THROMBOCYTIC HEMOSTASIS**

Cuff test (test with a tourniquet) of Konchalovsky–Rumpel–Leede. A circle of 5 cm in diameter is outlined on the internal surface of the upper third of the forearm, then the shoulder is squeezed with the cuff of the tonometer for 5 min at BP equal to 90–100 mm Hg. In 5 min after taking off the cuff the number of petechiae in the outlined circle is calculated (the norm — up to 10 petechiae, a slightly positive test — 11–20 petechiae, a sharply positive test — over 30).

The cuff test is positive in thrombocytopenia, in dysfunction of thrombocytes, hereditary and acquired.

Bleeding time (BT). The method allows the assessment of the vessels state after interaction of thrombocytes and vascular wall. BT is determined by a modified method of Ivy. After applying the cuff on the upper third of the forearm and creating the pressure of 40 mm Hg there, an incision is made on the skin of the flexor surface of the forearm 1×9 mm in size with a disposable matrix. BT is the time necessary for stopping the bleeding, in norm it is 3–8.5 min.

Progressive increasing of the bleeding time is observed, when the thrombocyte count is decreased, in primary impairment of the vascular wall, in qualitative impairments of thrombocytes, in Willebrandt's disease.

EVALUATION METHODS OF THROMBOCYTE FUNCTIONS

Investigation of the ability of thrombocytes for adhesion. It is determined by passing the blood through a standard column with glass balls or glass fiber resulting in a decrease of the thrombocyte count. It is the difference between the thrombocyte count before and after filtration that determines the degree of thrombocytes adhesiveness that in norm is 20–50 %.

A sharp decrease of adhesiveness (<10 %) is marked in qualitative impairments of thrombocytes, Willebrandt's disease.

Investigation of thrombocyte aggregation. A test for the aggregation ability of thrombocytes is performed in plasma, that is rich with them, where such inductors as ADP, adrenalin, collagen, free fatty acids are added. The aggregatometer allows a constant fixation of intensity fluctuations of the passing light through the plasma. The formation of aggregates is accompanied by an increase of light permeability.

The addition of inductors in specific concentrations causes a typical double-wave aggregation. The first wave determines a decrease of thrombocytes, the second — reflects the synthesis of thromboxane and thrombocytic secretion (a release reaction).

In thrombocytopathies the thrombocytic aggregation under the action of aggregating agents is absent.

EXAMINATION METHODS OF COAGULATORY HEMOSTASIS

FACTOR CHARACTERIZING THE I-ST PHASE OF COAGULATION — PROTHROMBINASE FORMATION

Activated partial thromboplastin time (APTPT). It allows making a judgment regarding the presence of plasmatic factors of blood coagulation taking part in activation of blood coagulation by the internal mechanism. To perform the test an activating agent is used (ground silicon oxide or kaoline) — a substitute of phospholipids of thrombocytic membrane, calcium and plasma of a diseased and a healthy person. After addition of an activating agent to the plasma, an active serine center FXII «is opened» resulting in subsequent activation of coagulation factors by the internal mechanism as well as factors X, V, II and I. The activating agent binds activated factors IX, X, V and II. This process is accelerated in the presence of added calcium and is accompanied by the formation of a clot. The termination of coagulation is registered in seconds. The amount of APTPT is in norm 25–38 sec.

APTT increases in deficiency of FXII, FXI, FX, FVIII, FV, FII, FI, prekallikrein and high molecular kininogen.

FACTORS, CHARACTERIZING THE 2-ND PHASE OF COAGULATION — THROMBUS FORMATION (PTI, INR)

Prothrombin time (PT). This test allows evaluating the presence of FXII which participates in the external mechanism of coagulation activation, as well as FX, FV, FI and FII. A tissue factor and calcium are added to the patient's plasma. The tissue factor activates FII that in its turn activates FX, FV, Ca and FII resulting in the thrombin formation. Thrombin is transformed into fibrinogen and fibrin. PT does not account for the state of the internal coagulation mechanism. In norm PT is 10–14 sec.

PT increases in persons with hereditary deficiency of FVII, FX, FV, FII and FI or acquired combinatory deficiency of factors, e. g. in deficiency of vitamin K, peroral administration of anti-coagulants.

Evaluation of prothrombin index (PTI). This index allows evaluating the presence of hypocoagulation due to deficiency of coagulation factors participating in the external mechanism. It is calculated on the basis of a specific prothrombin time.

$$PTI = \frac{PT_{\text{patient}}}{PT_{\text{donor}}} \times 100 \% = 70\text{--}110 \% (0.7\text{--}1.1)$$

Interpretation: values of PTI <70 % point out to hypocoagulation in hereditary or acquired deficiencies of FVII, FX, FV, FII and FI as well as in taking indirect anticoagulants blocking the synthesis of vitamin-K-dependent factors in the liver.

PTI > 110 % cannot testify to hypercoagulation as this test is insensitive to it; it may evidence the defect of determination.

Evaluation of international normalized ration (INR). Unlike the previous test, where the standard is mixed plasma from 10 donors, this test uses a standardized thromboplastin with specific sensitivity, activity of about 1.2 sec that allows a precision evaluation of the degree of hypocoagulation expressivity, to carry out monitoring in patients taking indirect anti-coagulants. Evaluation of INR is performed by an apparatus method.

$$INR = \left(\frac{PT_{\text{donor}}}{PT_{\text{patient}}} \right)^{isi} = 0.7\text{--}1.1,$$

where isi — international sensitivity index of thromboplastin (the index for a concrete manufactured thromboplastin) = 1–1.9.

The values of INR > 1.1. point out to hypocoagulation in the 2-nd phase of coagulation. The therapeutic domain of INR values in anti-coagulant therapy is 1.6–2.6. When INR = 4, there is a danger of severe bleedings. Just as the previous index, it does not characterize hypercoagulation.

FACTOR, CHARACTERIZING THE 3-RD PHASE OF COAGULATION — FIBRIN FORMATION

Thrombin time. It gives an idea about the state of a terminal blood coagulation. For this purpose the solution of thrombin is used, it causes coagulation on mixing with an equal volume of plasma for 15 sec and the temperature equal 37 °C.

A thrombin time increase is observed in hypofibrinogenemia, heparin excess, accumulation of fibrinogen degradation products in plasma, molecular abnormalities of fibrinogen, paraproteinemia.

EXAMINATION METHODS OF COAGULATORY HEMOSTASIS CHARACTERIZING HYPERCOAGULATION

Hypercoagulation can be evaluated by the following methods: APTPT, TT, evaluating the number of D-dimers, soluble monomer complexes of fibrin (SMCF), degradation products of fibrin (DPF).

SMCF (soluble monomer complexes of fibrinogen/fibrin) are formed, when fibrinogen is exposed to the action of thrombin, are determined in norm. They are fibrin-monomers consisting of domains D-E-D with open centers of polymerization. To form a fibrin-polymer from them the blood should accumulate their sufficient number, prior to this they are soluble fibrin-monomer complexes. They are determined by semi-quantitative sedimentation tests: orthophenanthralin, β -naphthalan and are evaluated in the number of pluses by the number and velocity sedimentation of flakes fallouts. The plasma has not become turbid — the result is negative. If the plasma has become turbid, there are clots — «++++».

This test evidences potential thrombogeneity of the plasma, circulation of a great amount of thrombin in the blood, the test conforms the DBC-syndrome.

The test is not strictly specific, other proteins having nothing to do with hemostasis (paraproteins, C-reactive proteins) may also precipitate.

FDP (fibrinogen-degradation products) are formed under the effect of plasmin upon fibrinogen, fibrin-monomer and not sewn transversely fibrin-polymer. They are D-E-D or D-E parts with open centers of polymerization. They may join fibrinogen, fibrin-monomer, block them or block coagulation. They produce an inhibitory effect on self-assembling of fibrin.

They are determined by a paracoagulatory tests. Hydrochloric orthrphenanthrolin (OPT) is added to the plasma separating the bonds of FDP, there occurs deblocking of polymerization centers in fibrinogen and the released fibrinogen results in blood coagulation (the test for FDP is positive). If there is no FDP,

then the addition of orthophenantralin results in no blood coagulation — the test is negative.

A positive test evidences the presence of hyperplasminemia, potential thrombogeneity of plasma as well as a possible presence of a thrombus.

Fibrin degradation products are referred to late D-dimer and at present are determined by a test for the D-dimer content.

D-dimer. The level of D-dimers characterizes the activity of the fibrinolysis system. When the transversely sewn fibrin is dissolved with plasmin, the areas consisting of D-E-D and D-E fragments of adjacent fibrin threads are formed, as plasmin cuts longitudinal bonds between D-E-D domains of fibrin, but they don't affect a transverse bond. Such fragments got the name D-dimers.

D-dimers are evaluated using test-strips by an immunometric method using human monoclonal anti-bodies to neo-antigen of D-dimers giving no cross reactions with SMCF and FDP. For determination one takes citrate thrombocyteless plasma. The stability of D-dimers in the citrate plasma at room temperature is 24 h after collecting the material. The norm of the blood content is up to 500 ng/ml (the test is negative) — a probability of thrombosis is 60 %, > 500 ng/ml — 98 % probability of thrombosis. In the normal course of pregnancy in norm the level of D-dimers is twice as high.

The increase of the D-dimers level may be observed in venous thrombosis, thrombophlebitis, thromboemboly of the pulmonary artery, DBC-syndrome (all phases), myocardial infarction, after surgical interventions.

SOME FACTORS IN THE HEMOSTASIS SYSTEM IN NORM

Factors of vascular-thrombocyte hemostasis

Cuff test (test with a tourniquet) of Konchalovsky–Rumpel–Leede	norm < 10 petechiae slightly positive 11–20 positive 21–30 sharply positive > 30
Bleeding time (BT)	3–8.5 min
Thrombocyte blood count	150.0–450.0 × 10 ⁹ /l

Factors of coagulatory hemostasis

Activated partial thromboplatelet time (APTPT)	25–38 sec
Prothrombin time (PT)	10–14 sec
Prothrombin index (PTI)	70–110 %
International normalized ration (INR)	0.7–1.1
Thrombin time (TT)	15–18 sec

Activity factors of the fibrinolysis system

Fibrin/fibrinogen degradation products (F/FgDP)	test is negative
Level of D-dimers	up to 500 ng/ml

CYTOCHEMICAL CHARACTERISTIC OF VARIOUS FORMS OF LEUCOSIS

FAB	Acute leucosis form	Reaction to nutrients			Reactions to enzymes			
		Glycogen Schiff (PAS)-reaction)	*GAG	Lipids (black sudan)	Peroxi-dase	Acid Phosphatase	α -naphtyl-esterase	Chlor-acetate-esterase
M0	Non-differentiated	–	–	–	–	–	–	–
M1 M2	Myeloblastic	+	–	+	+	+	slightly+	+
M3	Promyelocytic	sharply+	+	+	sharply+	slightly+	slightly+	sharply+
M4	Myelomonoblastic	+(diffuse)	–	–	highly+	+	+	slightly+
M5	Monoblastic	slightly+	–	slightly+	slightly+	highly+	+	–
M6	Erythromyeloblastic	+	–	Reactions depend on belonging of blast elements to this or that row (myeloblasts, monoblasts, non-differentiated blasts)				
M7	Megakarioblastic	Is defined by characteristic morphology of cells						
	Lymphoblastic	+ (as lumps)	–	–	–	Sometimes+	–	–
	Plasmoblastic	Is defined by characteristic morphology of cells & the presence of para-protein in the blood serum						

* GAG-glycozaminoglycains.

LESSON 8. INSUFFICIENCY OF BLOOD CIRCULATION. ACUTE CARDIAC INSUFFICIENCY. CORONARY INSUFFICIENCY. SITUATIONAL TASKS

№ 1

Patient K., 34 years, was delivered to clinic with a fracture of the right hip. On the next day severe pains in the thoracic cavity developed. The skin integuments became cyanotic. RR — 36 resp. per min. HR — 116 beats/min. BP — 85/60 mm Hg. The borders of the heart — in norm. Sharp swelling of cervical veins was observed. The liver is enlarged in size. On the X-ray film of the thoracic organs a cone-shaped shadowing is clearly marked in the lower lobe of the right lung. The oxyhemoglobin content in the arterial blood — 85 %, in the venous blood — 30 %. The erythrocyte count in the peripheral blood is $5.0 \times 10^{12}/l$, leukocytes — $16 \times 10^9/l$.

Questions:

1. What caused the insufficiency development of blood circulation?
2. What type of cardiac insufficiency is there in the patient?
3. What is the pathogenesis of clinical symptoms?

№ 2

Patient M., 46 years, developed severe pains behind the breastbone during intensive physical work in the garden; they were controlled by nitroglycerin. Previously squeezing pains in the heart area had occurred on physical exertion, but they subsided quickly at rest. In the evening the pains relapsed and were not controlled by nitroglycerin. There appeared breathlessness and cough with profuse liquid sputum. The patient was hospitalized.

Objectively: the patient is of a medium height, hypersthenic, the skin integuments and visible mucous membranes are pale with a cyanotic shade. The respiration is frequent — 42 resp./min. HR — 110 beats/min. On auscultation various moist râles are heard over the whole surface of the right and left lungs. The minute volume of the lungs is 2.8 l, BP — 110/70 mm Hg. The oxyhemoglobin content in the arterial blood is 81 %, in venous — 45 %. The erythrocyte count in the peripheral blood is $5.0 \times 10^{12}/l$, leukocytes — $11.9 \times 10^9/l$. The leukocyte formula: B — 0, E — 1, Y — 2, R — 7, S — 67, L — 19, M — 4.

Questions:

1. Is there any cardiac insufficiency in the patient?
2. Specify the main compensatory mechanism of hemodynamic impairments in the patient?
3. What syndrome is marked by an acute left-ventricular cardiac insufficiency in the patient?

№ 3

Patient A., 56 years, is in the department of intensive care with the diagnosis «Acute expanded myocardial infarction». On the 2nd day after a short-term improvement of the condition, despite the continuing therapeutic measures, breathlessness increased, profuse fine-vesicular râles in the lungs appeared.

Questions:

1. What pathologic processes in the respiratory and/or cardio-vascular system could cause the clinical picture of the patient's condition on the 2nd day?
2. What factors of the intracardiac and systemic hemodynamics can prove the presence and progressing of cardiac insufficiency in the patient? Specify these factors and point out the trend of their changes.
3. In case the version of cardiac insufficiency in this patient is confirmed, specify its type (by the affected part of the heart and the speed of its development). Is it possible to suggest that this insufficiency is of a) an overstrain type; b) a myocardial type; c) a mixed type? Prove your answer.

№ 4

Patient A., 50 years, was admitted to the intensive care department with complaints of squeezing pains behind the breastbone, weakness, breathlessness lasting for 20 h.

On examination: the state of a moderate severity, hyperemia of the face. On auscultation the respiration in the lungs is vesicular, no râles. RR — 16 resp./min, heart sounds are dull, rhythmic. HR — 80 beats/min. BP — 130/85 mm Hg. ECG: the rhythm is sinus, Q-segment is deepened and elevation of ST-segment in the first outlet with a mirror reflection in the III outlet. The activity of AST and LDH in the blood is sharply increased. Leukocytes — $12.3 \times 10^9/l$. Thrombocytes — $450 \times 10^9/l$. Prothrombin index — 120 % (the norm up to 105 %).

Questions:

1. The development of what disease does the described changes evidence?
2. In what department of the heart is the pathologic process localized?
3. Explain, what is the cause of the AST activity increase in this type of pathology?
4. What basic syndromes characteristic of this disease developed in the patient?
5. What is a possible development cause of this disease?

№ 5

In the experimental animal with cardiac insufficiency the cytoplasm of cardiomyocytes revealed an increased concentration of free calcium, sodium, hydrogen ions as well as a concentration decrease of potassium.

Questions:

1. Describe the consequences of ion imbalance in cardiomyocytes.
2. What is the basic cause of revealed impairments?

№ 6

Patient A., 62 years, is in hospital for expressed left-ventricular insufficiency due to myocardial infarction that he had suffered a month before. He is in a forced position. A considerable part of the day and night he is sitting on the bed with his feet on the floor. On an attempt to lie down his breathlessness sharply increases.

Questions:

1. What is the pathogenesis of breathlessness in left-ventricular insufficiency?
2. Why the severity of breathlessness in the patient in a sitting position is less than in a lying position?

№ 7

Patient B., 35 years, was delivered to the reception ward in a severe state with complaints for a tearing pain behind the breastbone, weakness. The persons accompanying the patient told that he felt bad in the tram, he suddenly became pale and damp with sweat. The passengers in the tram delivered him to hospital.

The doctor made the patient sit down, started to feel his pulse and take his blood pressure. The patient was pale, his skin integuments were damp, covered with drops of sweat. The pulse — 100 beats/min, of weak filling and tension. BP — 80/40 mm Hg. The doctor hadn't finished the examination yet, when the patient lost his consciousness. The pulse and blood pressure couldn't be defined. The pupils were dilated and didn't react to light, single respiratory movements were noted, cyanosis was increasing quickly. ECG registered in the Ist outlet looked like a wavy line.

The doctor and his assistants started reanimation: an external massage of the heart, respiration mouth-to-mouth, intravenous injection of lidocain. But despite the conducted treatment the patient died without recovering consciousness. On autopsy the pathology capable of causing death was not revealed. Coronary arteries — without changes, focal changes in the myocardium are absent.

Questions:

1. Taking into account the clinical picture and the autopsy data, what is a direct cause of death by your opinion?
2. Were there any mistakes made while rendering aid to the patient?

№ 8

Patient P., 48 years, was delivered to the reception ward with complaints of the sharpest pain behind the breastbone irradiating to both scapulars that wouldn't be controlled by nitroglycerin. For the last 10 days he noted a periodically occurring pain behind the breastbone being of less intensity and duration.

On examination: the condition was severe, the skin integuments were pale, damp with sweat. The pulse — 120 beats/min, of weak filling, arrhythmic. BP — 85/40 mm Hg. Heart sounds are dull. RR — 28 resp./min. Respiration in the lungs is vesicular. The liver is not enlarged, no edemas. While talking with the doctor he suddenly lost his consciousness, his BP decreased up to 70/30 mm Hg. After an urgent injection of cardiogenic preparations the patient recovered his consciousness.

ECG: in I, II, aVL, V₂-V₆ outlets the segment ST is arch-like shifted, T-segment is negative in the same outlets.

Questions:

1. What is your preliminary diagnosis? In what way can the severity degree be characterized on the moment of death?
2. List the types (severity degrees) of cardiogenic shock.

ADDITIONAL INFORMATION

Table 1

Localization of myocardial infarction by ECG changes

I, aVL, V ₄ -V ₆	lateral
II, III, aVF, I, aVL, V ₄ -V ₆	inferior-lateral
V ₁ -V ₃	frontal-septal

V ₄	apical
I, aVL, V ₁ -V ₆	frontal-lateral
V _{4R} , V _{SR} *	right ventricular
II, III, aVF	inferior
Ratio R/S > in outlets V ₁ -V ₂	Posterior

LESSON 9. CHRONIC CIRCULATORY INSUFFICIENCY OF CARDIAC GENESIS

SITUATIONAL TASKS

№ 1

Patient T., 45 years, suffers from a combined heart defect developed on the background of rheumatism she had suffered in youth. For many years she felt satisfactory. However after quinsy she has suffered this year her condition considerably aggravated. The patient is troubled with breathlessness, palpitation, pain in the heart area, hemoptysis, edemas.

Objectively: the skin integuments and visible mucous membranes are cyanotic. Percussion established dilation of the heart borders to all sides. A cardiac beat is generalized, weak. Systolic and diastolic murmurs are heard at the apex. The second sound over the pulmonary artery is increased and split. The pulse — 96 beats/min, arrhythmic. BP — 130/80 mm Hg. Moist râles are heard in the lungs. The liver is enlarged, tender on palpation. Marked edemas on the legs. Erythrocyte count in the blood is elevated. The circulating blood volume is increased. The stroke volume is decreased.

Questions:

1. What signs of circulatory insufficiency are there in the patient?
2. Explain the pathogenesis of clinical manifestations of circulatory insufficiency.
3. Why do the changes of factors of the central hemodynamics and circulatory system in the patient occur?

№ 2

Patient X., suffering from arterial hypertension, referred to clinic with complaints of periodically occurring breathlessness with difficult and unsatisfied inspiration, especially expressed on physical exertion. Some days ago, at night, he had a severe attack of inspiratory breathlessness («asthma») with a fear of death. Due to this an ambulance was called in, the doctor made a diagnosis «cardiac asthma».

On examination: BP — 155/120 mm Hg, on X-ray — dilation of the left ventricle borders.

Questions:

1. What form of pathology of cardiac activity developed in the patient? What is a direct cause of its development? Is its pathogenesis associated with overloading of the ventricle? Which one? Was the overloading caused by the volume of pressure?
2. What is the impairment mechanism of a contractile function of the myocardium in its overloading?
3. Name and ground the treatment principles of cardiac insufficiency.

№ 3

Guinea pigs with various degrees of hypertrophy of the myocardium due to physical loading of various intensity and duration were forced to swim to complete exhaustion.

Question: In what animals will the physical exhaustion occur earlier during swimming: in those with the greatest or the least degree of myocardial hypertrophy? Prove your answer.

№ 4

The compensatory hyperfunction of the myocardium in experimental animals was induced by constriction of the aortal mouth. Constant loading with resistance in 1.5 months resulted in the development of mechanisms of long-term adaptation of the heart to increased loading.

Question: Will a long-term adaptation of the heart develop, if the experimental animals are injected non-toxic doses of actinomycin D inhibiting the protein synthesis?

№ 5

Patient P., 9 years, was admitted to the cardiological department with complaints of the body temperature elevation, pains and swelling of knee and mortis joints, weakness, decrease of appetite.

Objectively: the child's condition is of a moderate severity. The boy is of reduced nutrition, pale. The pulse is 80 resp./min at rest, changing of the posture in bed causes tachycardia. A heart beat is increased. Left borders of the heart are dilated by 1.5 cm. The sounds are dull. Intensive systolic murmur at the apex.

Diagnosis: rheumatitis, a recurrent attack. Moderate endomyocarditis on the background of the mitral valve insufficiency.

Questions:

1. What type of cardiac insufficiency has the child?
2. What caused the dilation of the heart borders, what is its significance?
3. What type of hemodynamic overloading takes place in this case?

LESSON 10. ARRHYTHMIAS. THE IMPAIRMENT OF EXCITABILITY, AUTOMATISM AND CONDUCTION OF THE HEART

Work 1. DETERMINATION OF THE CARDIAC RHYTHM

№ 1, № 2, № 3, № 4, № 5, № 6, № 7, № 8, № 9, № 10, № 11, № 12.

TEST-TASK FOR SELF-CHECK OF LEARNING THE TOPIC

Choose correct answers of the given variants to every task, specifying, which types of arrhythmia and other forms of cardiac pathology are registered on ECG № 1–11.

№ 1

- a) paroxysmal ventricular tachycardia;
- b) ventricular palpitation;
- c) sinus tachycardia;
- d) polytopic extrasystole.

№ 2

- a) polytopic ventricular extrasystole;
- b) group monotopic ventricular extrasystole.

№ 3

- a) acute macrofocal MI of the posterior wall of the left ventricle (LV);
- b) acute macrofocal MI of the anterior wall of LV;
- c) acute macrofocal IM of the apical part involving the lateral wall of LV.

№ 4

- a) macrofocal MI of the inferior wall of LV;
- b) incomplete A-B blockade of the II degree, Mobits 1;
- c) incomplete A-B blockade of the II degree, Mobits II;
- d) right-ventricular ES (extrasystole) on bigeminy type;
- e) complete A-B blockade.

№ 5

- a) palpitation of atria;
- b) flickering of atria.

№ 6

- a) palpitation of ventricles;
- b) palpitation of atria; flickering of atria.

№ 7

- a) right-ventricular ES on bigeminy type;
- b) left-ventricular ES on bigeminy type;
- c) sub-ventricular bigeminy.

№ 8

- a) complete A-B blockade;
- b) single ventricular extrasystole;

- c) incomplete A-B blockade of the II degree, Mobits II;
- d) right-ventricular ES on bigeminy type.

№ 9

- a) polytopic ventricular extrasystole;
- b) monotopic ventricular extrasystole;
- c) sub-ventricular extrasystole.

№ 10

- a) complete A-B blockade;
- b) incomplete A-B blockade of the II degree, Miobits I;
- c) incomplete A-B blockade of the II degree, Mobits II.

Correct answers to the questions:

- | | |
|-------------|-------------|
| № 1 — a; | № 6 — b; |
| № 2 — b; | № 7 — a; |
| № 3 — a; | № 8 — a, b; |
| № 4 — a, e; | № 9 — a, c; |
| № 5 — b; | № 10 — c. |

**LESSON 11. PATHOPHYSIOLOGY OF THE CIRCULATION SYSTEM
(FINAL SEMINAR LESSON)**

SITUATIONAL TASKS

№ 1

Specify clinical manifestations characteristic of the hypertonic disease, and pathophysiological mechanisms of their occurrence?

1. Headache.
2. Loss of consciousness.
3. Dizziness.
4. Nausea.
5. Pernicious vomiting.
6. «Flashing flies» before eyes.
7. Stabbing pain in the heart area.
8. Tachycardia.
9. Loss of hearing.
10. Loss or deterioration of sight.
11. Breathlessness.
12. Attacks of an asthma.
13. Attacks of pain behind the breastbone.
14. Edema.
15. Impairment of cardiac rhythm.

№ 2

Which of the symptoms are characteristic of an uncomplicated course of the hypertonic disease, which of them — of the arterial hypertension caused by chronic glomerulonephritis?

1. High systolic and diastolic pressure.
2. Edema of the face, trunk, extremities.
3. Headache.
4. Dilation of the heart borders to the left.
5. Accent of sound II and systolic murmur over the aorta.
6. Proteinuria.
7. Hematuria.
8. Cylinduria.
9. Changes in the eyeground.
10. Hyperazotemia.
11. Hypercholesteremia.
12. Hypoizostenuria.
13. Normochromous anemia.
14. Hypokaliemia.
15. High pulse pressure.

№ 3

Patient G., 47 years, complains of a headache, mainly, in the occipital area, memory impairment, decrease of workability, dizziness, a periodically arising pain in the heart area, nausea, flashes before the eyes. Has been ill for 2 years, self-treatment was of no effect, the condition becomes gradually worse. The anamnesis revealed that the patient spent practically the whole day at work (works as an investigator at the Procurator's), smokes per 1–1.5 packs of cigarettes a day. Has an aggravated heredity on cardiovascular diseases: his father suffered two strokes at the age of 52 and 58 years.

On examination: the patient of increased nutrition, his body weight index — 30, the pulse — 96 per minute, of increased tension, the heart borders are shifted to the left by 1 cm, arterial pressure — 155/95 mm Hg.

Results of additional investigation: the total urine test — without pathological changes; on the electrocardiogram — hypertrophy signs of the left ventricle, on examination of the eye ground there was revealed dilation of veins and narrowing of arteries of the retina; biochemical blood test: the glucose level — 6.8 mmol/l, the content of total cholesterol — 7.1 mmol/l.

Questions:

1. What is your suggested diagnosis? Specify the stage.
2. List the regulated and non-regulated risk factors in the given patient.
3. Specify possible approaches to correct the regulated risk factors.
4. List the organs-targets affected in the given pathology.

№ 4

Patient C., 38 years, was admitted to the therapeutic department for a severe headache manifested as periodical recurrent attacks accompanied by the feeling of fear, palpitation, shivering, sensation of heat in the whole body, profuse perspiration, impairment of sight and increase of arterial pressure up to 250/130 mm Hg. The attacks last 10–25 minutes, subside by themselves, they appeared 3 years ago for the first time. APF inhibitors are inefficient.

On examination: the condition is satisfactory, the pulse — 90 per minute, is moderately tense, BP — 160/90 mm Hg. The heart sounds are high, the accent of sound II over the aorta. The abdomen is tenderless. The ophthalmologist revealed hypertonic angiopathy on the eye ground. The total tests of blood and urine — within the normal limits.

The sugar curve before loading — 5.4 mmol/l, after loading with 100 g glucose: 9.7 mmol/l – 12.3 mmol/l – 18.3 mmol/l – 7.2 mmol/l.

Reaction to vanillin — almond acid (+++). The content of adrenaline and noradrenaline in the blood is elevated.

Questions:

1. What is your suggested diagnosis?
2. What is the arterial hypertension in the given patient caused by?

№ 5

A student of a medical college K., 16 years, being present at a surgical operation for the first time, suddenly felt «faintness», which was accompanied by noise in the ears, dizziness, nausea and loss of consciousness. Objectively: the skin integuments were very pale, extremities — cold to touch. The pupils — narrowed. The heart sounds — dull. The pulse — 40 per minute, of weak filling. BP — 70/30 mm Hg. Respiration — rare. Spraying the face with cold water and inhalation of liquid ammonia vapors helped the patient to recover her consciousness quickly.

Questions:

1. To what pathology do the specified symptoms testify?
2. What are the development mechanisms of this condition?
3. What are the principal causes of the given pathology?

№ 6

Patient Zh., 52 years, was admitted to the pulmonological department with a bilateral pneumonia. Fell ill 5 days ago. Objectively: the condition of a moderate severity. The body temperature — 40,2 °C. The heart borders — dilated, heart sounds — dull. Systolic murmur is heard at the apex. BP — 105/70 mm Hg. The pulse — 105 beats/min, of weak filling. The percussion sound over the lower lobes of the right and left lung — dull, fine vesicular râles and crepitations were heard. Antibacterial therapy was administered. The patient developed profuse perspiration at night. The body temperature returned to the norm by

the morning. The condition became considerably worse, dizziness and nausea appeared. The pulse became threadlike, BP decreased. The patient lost consciousness. Emergency medical therapy allowed to control this condition.

Questions:

1. To what pathology do the specified symptoms testify?
2. What is its pathogenesis?
3. List the types and major factors of the given pathology pathogenesis?

№ 7

Patient A., 43 years, applied to the clinic of plastic surgery to correct the excessive body weight. The patient works as a sales manager of the firm, works a lot, smokes, often snacks in the nearest coffee house. His usual days off begin with a corporative party.

Objectively: the height — 164 cm; weight — 86 kg. Waist — 92 cm, hips — 102 cm.

BP — 145/90 mm Hg. ECG: hypertrophy signs of the left ventricle. Ultrasonic examination of the abdominal organs: thickening of the bile bladder walls, the presence of concrements there.

Total blood test — within the norm. Biochemical blood test: glucose on an empty stomach — 6.3 mmol/l; total cholesterol — 6.5 mmol/l; LPHD — 0.8 mmol/l; LPLD — 2.3 mmol/l; triglycerids — 2.4 mmol/l. A peroral test for glucose tolerance revealed impaired tolerance to glucose.

After careful examination and several talks with the patient the operation was declined, she was recommended to correct the style of life.

Questions:

1. Calculate the body weight index (BWI), $BWI = \frac{\text{weight (kg)}}{\text{height (m)}^2}$, make a conclusion regarding the patient's body weight (see add. information).
2. Calculate the waist-hip ratio (WHR), $WHR = \frac{\text{waist (cm)}}{\text{hips (cm)}}$, make a conclusion regarding the type of obesity (see add. information).
3. Characterize the factors of carbohydrate and lipid exchange.
4. Taking into account the clinical and laboratory data characterize the condition of patient A.
5. List the diseases, the risk of which is sharply increased in the given condition.
6. List the pathogenesis components of the given condition; specify the leading component of pathogenesis.

ADDITIONAL INFORMATION

Metabolic syndrome

The metabolic syndrome — is the total of clinical and laboratory signs, including:

1. *Abdominal type of obesity*. Criteria:

- a) increased BWI (see below);
- б) waist length that exceeds 88 cm in women, and 102 cm in men;
- в) WHI (volume in the waist/volume in the hips), exceeding 0.85 in women, and 1.0 — in men.

2. *Arterial hypertension.*

3. *Resistance to insulin* (impaired tolerance to glucose); the level of glucose on an empty stomach exceeding 6.1 mmol/l.

4. *Hypercholesterinemia and dyslipoproteinemia of an arterogenic character.*

A number of authors also include *hyperuricemia, hyperfibrinogenemia* and *hypertrophy of the left ventricle* into the metabolic syndrome.

Body weight index (BWI)

BWI — is a parameter describing deviations from an ideal body weight. It is calculated as a ratio of the body weight (kg) to height (m), squared.

$$\text{BWI} = \text{body weight/height}^2 \text{ (kg/m}^2\text{)}.$$

Norm — 18.5–24.9;

Excess weight — 25–29.9;

I obesity degree — 30–34.9;

II obesity degree — 35–39.9;

III obesity degree — over 40.

DM diagnosis and other categories of hyperglycemia (WHO, 1999)

Diagnosis	Glucose concentration (mmol/l) in capillary blood	
	On an empty stomach	In 2 hours after loading with glucose
DM	>6.1	>11.1
Tolerance impairment to glucose	>6.1	6.7–10.0
Impaired glycemia on an empty stomach	5.6–6.1	<6.7

LESSON 12. PATHOPHYSIOLOGY OF THE EXTERNAL RESPIRATION SYSTEM. TYPICAL IMPAIRMENTS OF PULMONARY FUNCTIONS

SITUATIONAL TASKS

№ 1

While investigating the flow factors of pulmonary ventilation of patient K., 52 years, with chronic bronchitis and pneumosclerosis the following data were received*:

Factor	Measured value	Proper value (calculate)	% of the proper value
Forced pulmonary capacity (FPC)	2.50 l		67

Forced expiratory volume (FEV ₁)	2.05 l		69
Maximum expiration flow (MEF ₂₅)	2.33 l/sec		40
MEF ₅₀	2.14 l/sec		57
MEF ₇₅	1.46 l/sec		103
Tiffno's Index (calculate)			

Construct the curves «flow–volume» for the proper (calculated) and measured (actual) factors of patient K.

Make the conclusion about the character of impairments of pulmonary ventilation.

№ 2

While investigating the flow factors of pulmonary ventilation in patient B., 42 years, with chronic bronchitis, the following data were received*:

Factor	Measured value	Proper value (calculate)	% of the proper value
FPC	4.55 l		91
FEV ₁	2.66 l		68
MEF ₂₅	5.45 l/sec		68
MEF ₅₀	2.16 l/sec		44
MEF ₇₅	0.38 l/sec		21
Tiffno's Index (calculate)			

* The investigation data are received by assistant T. V. Korotkevich on the basis of City Clinic Hospital № 9 in Minsk.

Construct the curves «flow–volume» for the proper (calculated) and measured (actual) factors of the patient.

Make the conclusion about the character of impairments of alveolar ventilation.

№ 3

Patient C., 24 years, was admitted to clinic with complaints of breathlessness and palpitation on physical exertion, dull pains in the heart area. During especially marked breathlessness a small amount of mucous sputum with blood is discharged. On the basis of the above complaints of the patient and subsequent examination the impairment of pulmonary circulation due to mitral stenosis was suggested.

Test results of the external respiration system:

Respiration rate — 20 per minute;

PC (pulmonary capacity), % of the proper value — 81;

RPC (residual pulmonary capacity), % of the proper value — 76;

MV (minute volume), % of the proper value — 133;

FPC, /PC, % — 80.

Questions:

1. What impairment types of pulmonary perfusion are possible in the given patient? Prove the answer.
2. Explain the possible mechanisms of reducing PC and RPC in the patient.
3. Is there any impairment of alveolar ventilation of an obstructive type in the given patient? Prove the answer.

№ 4

Patient A., 43 years, a press operator of fire-resistant bricks with 20-year experience of work, complained that he had difficulty while coping with work because of breathlessness on physical exertion.

On objective examination the pallor of integuments was noted. The thorax was of a regular shape, both halves of it actively participate in the respiration act. The mobility of pulmonary edges was limited. Respiration — rough; dry scattered râles are heard.

On X-ray — the pulmonary pattern is changed on a cellular pneumosclerosis type.

Moderate reduction of external respiration efficiency is revealed — saturation of arterial blood with oxygen is 74 %.

Questions:

1. The functional impairment of what component of the external respiration system is the main cause of its insufficiency in this case?
2. What is your explanation of the fact that breathlessness in the patient develops only on physical exertion?
3. What elementary functional test allows estimating the condition of diffuse pulmonary capacity in the patient?

№ 5

Patient G., 38 years, is in hospital for a closed fracture of X and XI ribs on the right, not complicated by the damage of pulmonary tissue.

The general condition is satisfactory. The respiration rate — 13 resp. per minute, respiration is superficial. The right half of the thorax lags behind during respiration.

General spirometry revealed: the tidal volume is 83 %, minute volume — 82 %, pulmonary capacity — 90 % of the norm.

Question: What type of the pulmonary ventilation impairment takes place in this case?

№ 6

Patient T., 19 years, on the 3-rd day of the disease applied to the doctor and was referred to hospital with the diagnosis of «acute pneumonia».

On admission the respiration was — 32 per minute, superficial. Intercostal muscles participate in respiratory movements. On auscultation fine bubbling moist and dry râles are heard.

On X-ray of the lungs — changes, characteristic of bilateral croupous pneumonia.

On examination of the external respiration efficiency a decrease of blood oxygenation is revealed — saturation of arterial blood was 86 %.

Questions:

1. What pathological type is present in the patient and what is the mechanism of its development?
2. What impairment of external respiration processes is the main cause of the blood oxygenation decrease in this case?

№ 7

The blood test for gases of patient M., 49 years, with respiratory insufficiency revealed, that at rest: PaO₂ — 83 mm Hg, PaCO₂ — 40 mm Hg. After the test with arbitrary hyperventilation within 2 minutes: PaO₂ — 65 mm Hg, PaCO₂ — 38 mm Hg.

Questions:

1. What is a possible cause of developing respiratory insufficiency by the patient?
2. Why does hyperventilation aggravate hypoxemia?

№ 8

Patient B., 56 years, was admitted to the neurological department for a cerebral stroke. On admission the condition was severe. Periodic respiration of a tidal type is observed. On the 2nd day of the patient's staying in hospital the tidal respiration in the patient changed for Biot's (meningitic) respiration.

Questions:

1. Is it possible to regard the appearance of Biot's (meningitic) respiration as a prognostically favorable symptom?
2. What factor is of major importance in the pathogenesis of periodic respiration?

№ 9

Patient P., 52 years, is delivered to hospital with uremia. The patient is adynamic, sleepy. The face is puffy; the skin is dry and flabby with traces of multiple scratches. Breathlessness is observed, the phase of an inhalation and an exhalation being intensified and the rhythm being accelerated.

On 4-th day of staying in hospital, despite the undertaken measures, deterioration occurred: the patient developed a coma, the reaction of pupils to light — inert, she is in unconscious state. Some kind of noisy accelerated respiration appeared, deep inhalations are regularly alternated with deep exhalations.

Questions:

1. What form of respiration impairment appeared in the patient?

2. Will the breathlessness persist in the patient in a coma? Prove the answer.

№ 10

A 45-year old woman referred to the reception ward of the clinic with complaints of the feeling of «shortage of air» and pressure in the breast. In the anamnesis — pneumonias and other diseases of respiratory organs. On auscultation the accent of the 2nd sound over the pulmonary artery is revealed. The X-ray examination of the thoracic organs and ECG showed the signs of hypertrophy of the right ventricle.

Questions:

1. What pathological condition did you suspect in the patient?
2. What is the pathogenesis of the right ventricle hypertrophy in chronic pulmonary diseases?

№ 11

Tolya B., 3 years, was admitted to clinic with symptoms of rough breathing. Fell ill 2 days ago. The body temperature — 38.7 °C. The palatal arches and soft palate are covered with dirty-grey coatings. A whistling sound is heard on inhalation. The inhalation is of a prolonged character. A pause between an inhalation and an exhalation is lengthened. On inhalation the sinking of soft parts of sub- and supra-clavicular foci, and also of intercostal interspaces is marked. The face is puffy, of a lead shade with cyanosis of the nose tip and auricles.

Questions:

1. What is the name of a changed type of breathing registered in the patient?
2. Draw a grounded conclusion regarding the form of external respiration impairment.

ADDITIONAL INFORMATION

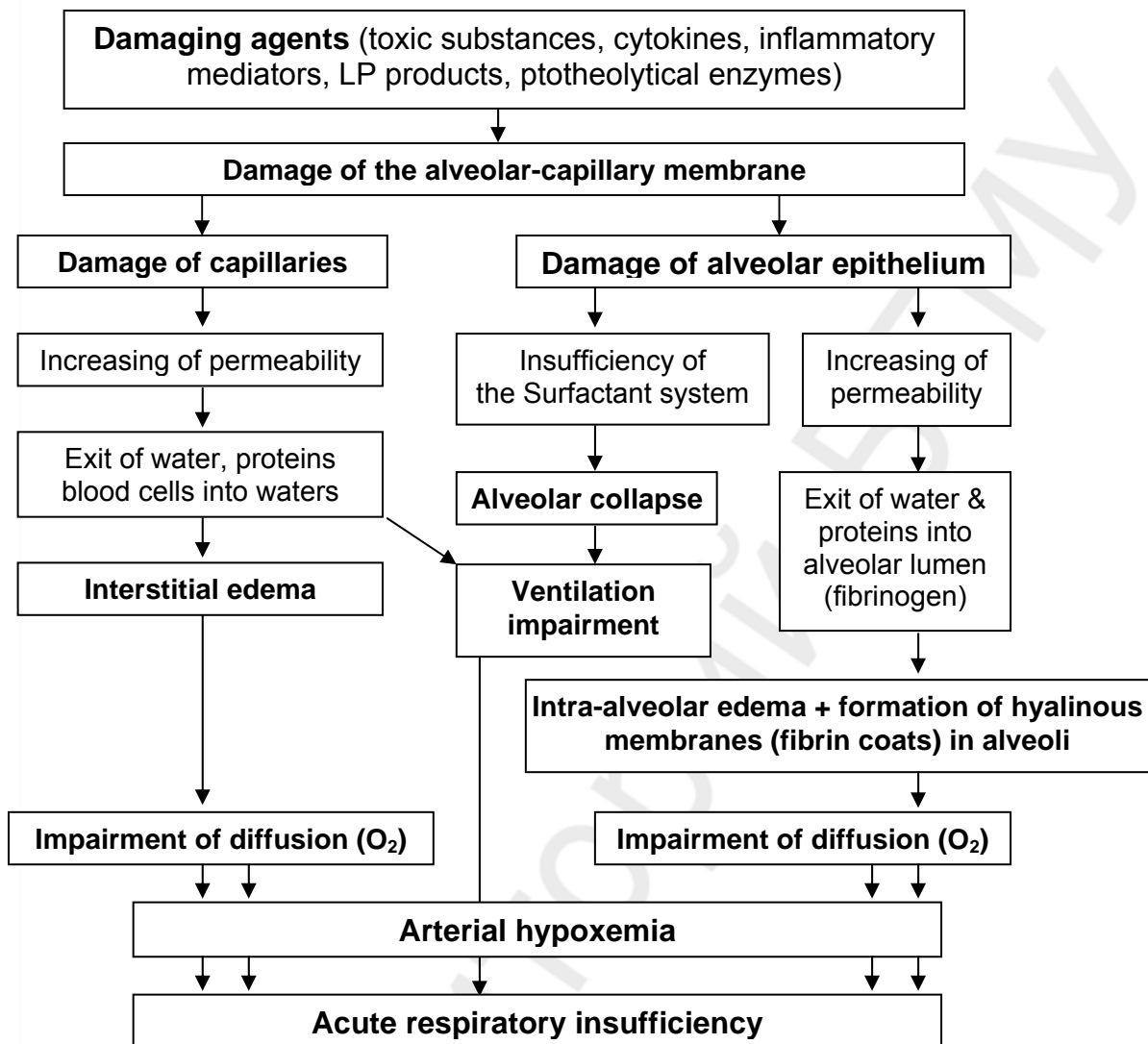

Fig. 3. Pathogenesis of a respiratory distress-syndrome of adults

LESSON 13. PATHOPHYSIOLOGY OF THE DIGESTIVE SYSTEM

SITUATIONAL TASKS

№ 1

Patient D., 35 years, was admitted to clinic with complaints of severe attacks of pain (a burning feeling) in the epigastric area occurring in 2–3 hours after meals; lately the pains started to be accompanied by nausea and sometimes by vomiting. Vomiting relieves the pain. The pains also appear at night, so the patient wakes up and takes food on an empty stomach. After this the feeling of pain disappears very quickly.

The patient is emotional, irritated, smokes a lot and abuses alcohol.

On the basis of the patient's complaints as well as the results of examination the diagnosis of «duodenal ulcer» was made and the proper treatment was administered that considerably improved his condition.

Questions:

1. On the basis of what results did the doctor make the diagnosis and administer the proper treatment?
2. What factors could cause this disease and what mechanisms underlie their action? Prove your answer on the basis of the anamnesis.
3. What are the causes for the development of pain (burning sensation) in the epigastric area?
4. What are your recommendations for the treatment of this patient?

№ 2

Patient B., 46 years, was admitted to clinic with the diagnosis «Suspected cancer of the pancreas». His body weight — 59 kg, the height being 179 cm; he had lost 14 kg of weight for the last year. Stool — 3–4 times a day, profuse. Meteorism. The tongue was coated, the appetite considerably decreased. There were no pains in the abdomen; the body temperature was in norm.

In the anamnesis: the patient has been abusing alcohol for 15–20 years; 10 years ago after a usual alcoholic excess he suffered acute pancreatitis (with hospitalization); after this there were 2–3 episodes of severe pains in the abdomen, but he didn't apply to the doctor, was not treated, didn't follow a diet, continued taking alcohol.

In the analyses made in the clinic: hyperglycemia — 20.6 mmol/l, glucosuria — 4 % (in diurnal diuresis of 3–4 l), marked steatorrhea, 5-fold reduction of the factor of maximum activity of tripsin as compared to the norm. The results of ultrasound examination and computer tomography of the pancreas: diffuse consolidation and inhomogeneity of the gland structure, the presence of calcificators there.

Questions:

1. Evaluate the functional state of the pancreas in the patient.
2. On the basis of the evaluation of the pancreas function give your suggestions regarding the pathological processes that have developed in the pancreas and their possible cause.
3. What additional examinations are required to confirm (or reject) the preliminary diagnosis in this patient with a greater degree of probability?
4. Can the suggested pathological processes develop in the pancreas independently on each other? Can they be interrelated in this case? If yes, what is their most probable sequence of occurrence?
5. What disease, to your opinion, does the patient suffer?
6. In what way can you explain such a considerable loss of weight of this patient lately?

№ 3

Two groups of animals were exposed to stimulation of gastric secretion. In one group it was vagus stimulation, in the other — a stressed one.

Question: Will the juice excreted in response to vagus stimulation be identical to that one on a stressed stimulation?

№ 4

Rats with the mass of 160–180 g were being injected intramuscularly 0.5–1.0 mg of hydrocortisone per 100 g of the animal weight daily. After 10–15 injections all the animals developed erosions or ulcers in the secretory department of the stomach.

Questions:

1. Explain the development mechanisms of a «hydrocortisone» ulcer of the stomach in experimental animals.
2. Give the situations, when a human may develop ulcers of similar pathogenesis.

№ 5

For reproduction of experimental gastric ulcers a ligature is applied to the pylorus preserving its passability (Sheia's method).

Questions:

1. What is the occurrence mechanism of gastric ulcer in applying the ligature?
2. Give the situations, when the human may develop ulcers with a similar pathogenesis.

№ 6

Three years later after a subtotal resection of the stomach the patient developed progressive anemia. The blood test revealed: erythrocyte count — $1.9 \times 10^{12}/l$, leukocyte count — $3 \times 10^9/l$, thrombocyte count — $100 \times 10^9/l$. In the smear: megalocytes, hypersegmentated neutrophils.

Question: Is there any interrelation between the above blood pathology and stomach resection performed earlier? If yes, what does it mean?

№ 7

Patient C., 42 years, was delivered to the reception ward of the clinic by an ambulance with complaints of a severe pain in the epigastric area in the left hypochondrium that irradiated to the lumbar area; he notes attacks of nausea and vomiting for the last 24 hours. He also confided that he had been in the state of alcoholic bout for 2 days when the painful symptoms developed and they recurred as soon as he tried to take alcohol during the last days. The biochemical blood test revealed hyperlipidemia, an increased content of lipase, α -amilase in the blood serum; leukocytosis in the total blood test. On physical examination: increased perspiration, the body temperature — 38.5°C , the abdomen is swelled, tense on palpation in the epigastrium and left hypochondrium.

Questions:

1. What pathologic process can be suggested in patient C.?
2. What etiological factors may cause a similar pathology?
3. What is the pathogenesis of an autodigestive syndrome in this disease?

№ 8

Two patients with diarrhea were admitted to the reception ward of the infection clinic.

Patient A., 36 years, had an acute disease. Complains of nausea, vomiting, spastic pains in the abdomen, a frequent, up to 10 times per 24 h, watery stool without blood or mucus. Has not been taking food for 24 hours. The temperature — 37.5 °C. HR — 110 beats/min. BP — 90/60 mm Hg. RR — 20 resp. per min. The tongue is dry, coated with white. The abdomen is soft, tender on palpation. The laboratory examination of feces revealed: osmolarity of feces — 290 mosmol/l, Na content — 100 mmol/l, that of K — 40 mmol/l.

Patient M., 42 years, has been suffering from diarrhea for 1 week. A liquid stool (up to 6 times a day) is provoked by taking food. The anamnesis contains the duodenal disease, due to which he has been taking maalox antacid for a long time. The body temperature — 36.8 °C. HR — 76 beats/min. BP — 130/75 mm Hg. The abdomen is swelled; on palpation it is tender in the epigastrium. The laboratory examination of feces revealed: Feces osmolarity — 330 mocmol/l, the content of Na — 30 mmol/l, K — 30 mmol/l.

Questions:

1. Assess the severity of patients A. and M.
2. Calculate the «osmotic difference» of the electrolytic composition of feces and make the conclusion regarding the suggested development mechanism of diarrhea in patients A. and M.
3. What laboratory examinations are necessary to make precise the causes of diarrhea in patients A. and M.?
4. Explain the development mechanisms of osmotic and secretory diarrhea.
5. What ABS impairment may occur in diarrhea, what are its manifestations?

ADDITIONAL INFORMATION

1. The ulcer is characterized by various intensity of gastric secretion depending on the site of ulcer localization. When the ulcer is localized in the duodenum, gastric secretion is continuous. The portion on an empty stomach reveals not only an increase of the volume of gastric content but also a considerable elevation of its acidity. The duodenal localization of the ulcer is characterized by high parameters of gastric secretion. The total acidity may reach 60–80 titr. units.

Increased secretory activity accompanies ulcers of the pyloric department of the stomach and antral ulcers in young people. In ulcers of the stomach body the secretory parameters slightly differ from the norm or decreased (due to associated gastritis) and only in some cases they are moderately elevated. The re-

vealing of achlorhydria in histamine stimulation in the patient with a gastric ulcer may be considered as a sign of malignization.

2. Chronic gastritis is characterized by a tendency for decreasing or increasing of gastric secretion. Chronic gastritis with hypersecretion more often occurs in young people. Revealing of hypersecretion in old people with prolonged gastric anamnesis makes to suggest a duodenal ulcer, but not gastritis. An increased secretory function of the stomach occurs in a focal antral gastritis. In some cases of gastritis without atrophy an increased concentration of hydrochloric acid and pepsin are noted.

In atrophic gastritis the insufficiency of the secretory function of the stomach is revealed. The degree of reducing the acidity depends on the expressiveness of atrophy. Histamine-reflector achlorhydria combined with the reduction or cessation of pepsin production evidences an advanced gastritis.

3. Functional diseases of the stomach:

a) «irritated stomach» — the secretory function factor is increased, however, the histological pattern of the mucous membrane of the stomach is normal. An excessive reaction to slight irritants (hyperreactive type of secretion) is very characteristic;

b) «functional achlorhydria — histamine-positive achlorhydria» is revealed on examination of the secretory function, in rare cases histamine-refractor (hyporeactive type of secretion) too. Histologic changes in the mucus of the stomach are absent.

4. Gastric cancer. Gastric cancer is characterized by a decrease of gastric secretion parameters, of hydrochloric acid in particular. Achlorhydria occurs in 55–60 % of gastric cancer cases, achlorhydria being histamine-refractor. Revealing of lactic acid in the gastric content is not an early sign of cancer. However in the forms accompanied by achlorhydria and the impairment of emptying the stomach a positive reaction to lactic acid may have an additional significance. For early diagnosis of cancer the method of gastroscopy with purposeful biopsy is of great significance.

Diurnal intragastric and intraepigastric pH-monitoring

The method of intragastric pH-metry is a functional electrometric method. The computer microprocessor system of «Gastroscan 1» type is used for monitoring, it being equipped with a transnasal pH-probe with three stibiated electrodes at the distance of 120 cm from each other that are fixed in an elastic polymer tube, and a supradermal chloral-silver electrode of comparison. The data recorded by a microprocessor system are input to the computer through the interface and processed by a special program.

The method allows studying the acid formation in the stomach during 24 hours, including the night secretion, effect of natural factors (changing the body position, taking food, medicines, smoking) on gastric secretion,

to assess the action of anti-secretory preparations, to distribute a diurnal dose of anti-secretory preparations in the most optimal way.

To interpret the examination results of gastric secretion the parameters of basal and stimulated secretion input by E. Yu. Linar and Yu. Ya. Leya are used.

Table 4

Assessment of a basal and stimulated pH of the stomach body and antral department (E. Yu. Linar, Yu. Ya. Leya)

Stomach body		Stomach dept. of the stomach	
Assessment of acid formation	pH value	Assessment of a neutralizing function	Ph value
Hyperacidity	<1.5	Compensation of alkalization in the antral dept.	>5.0
Normacidity, continuous acid formation	1.5–2.0	Subcompensation of alkalization in the antral dept.	2.0–4.9
Hypoacidity	2.1–5.9	Decompensation of alkalization in the antral dept.	<2.0

At present the following varieties of pH-metry are used:

- short-term (3-hour);
- long-term (monitored, 24-h);
- endoscopic (express-method).

Table 5

Pathogenetic classification of diarrhea (according to V. Yu. Shanin, 1998)

Diarrhea type	Main component of pathogenesis	Characteristic of feces	Disease and pathological conditions causing diarrhea of the given type
Secretory	Increasing secretion of Na-cation in the intestinal lumen as a cause of increasing the total osmole number there. Growth of the total osmole number increases the amount of the fecal mass through their dilution	Light, liquid. Total osmolarity in the intestinal lumen is approximately the total sum of osmotic concentrations of Na and K cations there multiplied by 2 (evidence of the absence of inabsorbable osmoles in the intestinal lumen)	1. Cholera. 2. VI Roma, gastrinoma (tumors of the pancreas, the cells of which secrete vasoactive intestinal peptid and gastrin). 3. Enteropathy (functional intestinal impairment due to intolerance of bile acids)
Exudative	Inflammation of intestinal walls as a cause of low intestinal absorption	Purulent. Contain polymorphonuclears and blood (evidence of ulceration of intestinal walls)	1. Ulcerative colitis. 2. Shigellosis. 3. Amebiasis
As a result of impaired absorption: osmotic	Growth of the total number of osmoles in the intestinal lumen due to appearance of inabsorbable molecules there. Such inabsorbable osmoles in particular may appear in the lumen	Total osmolarity of the liquid in the lumen is greater than the osmotic concentration of Na- and K-cations multiplied by 2 (evidence of appearance of inabsorbable osmoles in the lumen)	1. Chronic pancreatitis causing insufficiency in intraabdominal digestion. 2. Congenital deficiency of lactase. 3. Condition due to the action of laxatives con-

Diarrhea type	Main component of pathogenesis	Characteristic of feces	Disease and pathological conditions causing diarrhea of the given type
– due to loss of a part of the intestine	due to insufficiency of digestion Reduction of the area of the absorbing surface	Changeable	lacking Mg-cations 1. The condition after resection of over 50 % of the small intestine 2. Pathologic condition due to the result of <i>асвища</i> between the stomach and large intestine
– due to the intestinal motility impairment	Reduction of the time of intestinal absorption	Changeable	1. Hyperthyreosis 2. Syndrome of an irritated intestine

Types of gastric secretion

1. Inhibitory:

- prolonged latent period of secretion (between food stimulation of the stomach and the start of the secretion);
- decreased intensity of growing and activity of secretion;
- shortened duration of secretion;
- diminished secret volume;
- in the greatest degree of secretion inhibition *ahilia* develops — actually the absence of gastric juice.

2. Excitable:

- shortened latent period before the secretion starts;
- intensive growth of secretion;
- increased duration of the secretion process;
- increased volume of gastric juice.

3. Inert:

- increased latent period;
- inhibited growth of secretion;
- its slow cessation;
- increased volume of gastric juice.

4. Asthenic:

- shortened latent period of starting juice secretion;
- intensive start and fast reduction of secretion; small volume of gastric juice.

5. Chaotic:

- is characterized by the absence of any regularities of dynamics and secretion volumes, periods of its activation and inhibition within a prolonged period (several months and years);

- total amount of juice is increased as a rule.

LESSON 14. PATHOPHYSIOLOGY OF THE LIVER

SITUATIONAL TASKS

№ 1

The patient with insufficient secretion of bile into a small intestine and marked steatorrhea developed multiple hemorrhages.

Question: Explain the possible mechanisms of interrelations of the above pathologic processes.

№ 2

Patient K., 31 years, was delivered to clinic by an ambulance. On admission: passive, retarded, apathic, answers questions not always at once and adequately. The tongue is coated. The body temperature — 36.5 °C. Skin integuments and mucous membranes are of a yellowish color, there are teleangiectasias on the skin of the upper trunk, erythema of the palms is marked. The abdomen is enlarged due to ascites fluid that makes palpation of the liver difficult. Edemas of lower extremities are noted. The border of the left ventricle of the heart is slightly dilated. BP — 160/95 mm Hg, HR — 90 beats/min, the pulse is rhythmic.

The results of biochemical blood test: hyperbilirubinemia, hypoglycemia, hypoproteinemia, hypocholesterinemia, the urea content is decreased, the prothrombin index is reduced. The activity of AlAT and AsAT in blood is increased.

Questions:

1. What are the development mechanisms of teleangiectasias and persistent erythema of the palms in the patient? What other symptoms are caused by the same effect?
2. Specify the basic development causes of portal hypertension and ascites? What is the role of ascites in secondary impairments of the organism function?
3. Are there any laboratory symptoms of hepatic insufficiency? If yes, then what is their development mechanism?
4. How can you assess the state of consciousness in this patient?

№ 3

Specify the type of jaundice and give the conclusion.

Table 8

	Factor	Content	Norm
Blood	Bilirubin:		
	– indirect	51.3 mcmmol/l	8.5–20.5 mcmmol/l
	– direct	–	–
	Urobilin-(ogen)	++	–
	Stercobilin-(ogen)	+++	+
	Cholesterol	6.8 mcmmol/l	3.1–5.2 mmol/l
	Bile acids	–	–
Urine	Bilirubin:	–	–

	Urobilin-(ogen)	++	–
	Stercobilin-(ogen)	+++	+
	Bile acids	–	–
	Color	saturated yellow	straw-yellow
Feces	Stercobilin	+++	+
	Fatty acids	–	–
	Bile acids	+	±
	Color	dark-brown	brown

Table 9

	Factor	Content	Norm
Blood	Bilirubin:	342.3 mcmmol/l	8.5–20.5 mkmol/l
	– indirect	20.1 mcmmol/l	–
	– direct	322.2 mcmmol/l	–
	Urobilin-(ogen)	–	–
	Stercobilin-(ogen)	–	+
	Cholesterol	14.2 mmol/l	3.1–5.2 mmol/l
	Bile acids	+++	–
Urine	Bilirubin:	+++	–
	Urobilin-(ogen)	–	–
	Stercobilin-(ogen)	–	+
	Bile acids	+++	–
	Color	dark beer	straw-yellow
Feces	Stercobilin	–	+
	Fatty acids	+++	–
	Bile acids	–	±
	Color	grey-white clay	brown

Table 10

	Factor	Content	Norm
Blood	Bilirubin:	150.7 mcmmol/l	8.5–20.5 mkmol/l
	– indirect	20.5 mcmmol/l	–
	– direct	130.2 mcmmol/l	–
	Urobilin-(ogen)	++	–
	Stercobilin-(ogen)	++	+
	Cholesterol	10.2 mmol/l	3.1–5.2 mmol/l
	Bile acids	++	–
Urine	Bilirubin:	+	–
	Urobilin-(ogen)	++	–
	Stercobilin-(ogen)	++	+
	Bile acids	+	–
	Color	dark beer	straw-yellow
	Factor	Content	Norm
Feces	Stercobilin	±	+
	Fatty acids	+	–
	Bile acids	±	±
	Color	light-brown	brown

№ 4

After the symptoms of general malaise the patient developed yellowish coloring of sclera and the skin, itching; bilirubinuria, urobilirubinuria; the urine acquired the color of beer.

№ 5

What type of jaundice is characterized by bilirubinemia, cholelacidemia, bilirubinuria, urobilirubinuria?

№ 6

Patient I. at the age of 20 suffered serum hepatitis. After discharge from the hospital he didn't apply to doctors for a number of years. Periodically he was troubled by pains in the right hypochondrium, nausea, malaise. By 28 years his weakness increased. There appeared marked signs of «meduza's head» on the anterior abdominal wall, often he had diarrhea, hemorrhagic bleedings. Palpation revealed splenomegaly, the liver extending 2 cm from the costal arch, its edge being uneven.

Question: What syndrome develops in the patient? Name its form.

№ 7

What syndrome is characterized by a yellowish coloring of sclera and skin, bilirubinemia, bilirubinuria? Specify the possible causes of its development.

№ 8

Patient A. was delivered to clinic by an ambulance with profuse epigastric bleeding. Three years ago he was diagnosed cirrhosis of the liver.

Question: The complication of what syndrome was epigastric bleeding?

№ 9

The abdomen of the patient with cardiac insufficiency of the right-ventricular type in the stage of decompensation enlarged. Abdominal puncture revealed the presence of ascites.

Question: What syndrome is developing in the patient? Specify its form.

№ 10

A yellowish coloring of the skin and sclera in the newborn has been persisting for 3 weeks. Urobilin is revealed in urine. Feces are intensely colored. Rh-incompatibility of the mother and the child is revealed.

Questions:

1. What is the development mechanism of jaundice in the child?
2. To what type is it referred?

№ 11

Patient K. was admitted to the department of hepatology with symptoms of marked jaundice, psychomotor excitation and complaints of severe pains in the right hypochondrium, itching, nausea. There were revealed bilirubinemia, cholelacidemia, bilirubinuria, acholic stool.

Questions:

1. What form of jaundice is in this patient?
2. What is the most probable cause of its development?

№ 12

There is a yellowish coloring of sclera and skin integuments, severe itching, general malaise, increased excitability in the patient; the urine is of a beer color, he has an acholic stool, bilirubinemia, choleacidemia, bilirubinuria.

Question: Give a full name of the syndrome developed in this patient.

№ 13

The patient suffering from cancer of the pancreas head developed a yellowish coloring of the skin and sclera, itching. The tests of blood and urine revealed hyperbilirubinemia, cholalemia (cholacedemia), bilirubinuria.

Question: What form of jaundice developed in the patient?

№ 14

7 months ago girl M., 6.5 years, became listless, lost appetite, lost weight. Soon ascites developed and her legs swelled. Ascetic fluid was let out several times. The bilirubin content in the blood serum is increased. Multiple bruises, recurrent intestinal bleedings. The patient died in 11 months since the beginning of the disease in the state of cachexia. Her both brothers suffered from hepatocerebral dystrophy.

Question: What form of portal hypertension had the child?

ADDITIONAL INFORMATION

Table 11

Complications of hepatic insufficiency (pathogenesis)

Complications	Pathogenesis
Azotemia	Decrease of CBV. Acute tubular necrosis, hepatorenal syndrome
Cerebral edema	Impairment of vascular permeability, circulating toxins
Gastrointestinal bleedings	Erosive gastritis aggravated by coagulopathy and portal hypertension
Hypoxemia	Discharge of blood from the right to the left, non-cardiogenic pulmonary edema
Hypotension	Decrease of vascular resistance, sepsis, gastrointestinal bleedings
Acidosis	Decrease of tissue perfusion, decreased hepatic clearance of organic acids
Alkalosis	Hyperventilation (mainly of a central genesis)
Hypokalemia	Renal or gastrointestinal, loss of potassium
Hyponatremia	Reduced hepatic clearance of free water, taking liquids
Hypoglycemia	Reduced glycogenolysis and glyconeogenesis

Total lipids, g/l	4.0–8.0
Total cholesterol, mmol/l	3.1–5.20
Cholesterol LPHD, mmol/l	0.8–2.2
Cholesterol LPLD, mmol/l	<4,9
LPHD, g/l	2.57–4.56
LPLD, g/l	2.30–3.51
Triglycerides, mmol/l	0.50–2.10
Bilirubin, total, mcmol/l	8.5–20.5
Calcium, mmol/l	3.3–4.9
Chlorine, mmol/l	97–110
Serum iron, mcmol/l (male)	8.8–27
(female)	9.5–29
Potassium, mmol/l	3.8–4.7
Sodium, mmol/l	135–145

Clinical-biochemical hepatic syndromes

1. Cytolysis syndrome:

– increase in serum: activity AsAT, AlAT, LDH total and LDH₄₋₅, P-1-P-aldolase, sorbitoldehydrogenase, ornitincarbamoiltransferase, P-1,6-BP-aldolase, glutamatdehydrogenase, bilirubin, mainly a conjugated one, contents of iron and vitamin B₁₂.

2. Cholestase syndrome (excretory-biliary):

– increase of alkaline phosphatase, bilirubin and cholesterol. activity in the serum.

3. Hepatocellular insufficiency syndrome:

– decrease in the serum of: cholinesterase (butirilcholinesterase), prothrombin, cholesterol, albumin, glucose;
– increase of bilirubin in the serum.

4. Syndrome of hepatic reticuloendothelium irritation (mesenchymal-inflammatory):

– increase in the serum of: globulin (sometimes hyperproteinemia); modification of protein-sedimentary tests (a factor of the thymole test).

LESSON 15. PATHOPHYSIOLOGY OF KIDNEYS

Situational tasks

№ 1

The blood test of the patient with chronic glomerulonephritis revealed: erythrocyte count — $2.4 \times 10^{12}/l$, hemoglobin — 68 g/l, color factor — 0.85,

leukocyte count — $5.6 \times 10^9/l$. No marked shift in the leukocyte formula is revealed. In the smear: normochromia, anisocytosis, poikilocytosis.

Question: Can there be any interrelation between functional impairments of kidneys and the state of hemopoiesis?

№ 2

Patient B., 10 years, complains of general weakness, headaches, reduced appetite, thirst. In the anamnesis — frequent quinsy. The clinical-laboratory examination revealed physical development retardation, pale, dry and deciduous integuments. BP — 130/90 mm Hg. The blood test showed a slightly expressed anemia. Urea of blood — 8.9 mmol/l. Diurnal urine — 6–8 times a day, night urination takes place. Urine is straw-colored, transparent, of an acid reaction, relative density fluctuation is 1.009–1.017, protein — 0.2 g/l. In the deposit: a small amount of epithelium, leukocytes — 0–2 in the field of vision, erythrocytes, hyalinous cylinders — single in the preparation. Glomerular filtration rate by insulin — 50 ml/min.

Questions:

1. Are there any signs of renal insufficiency in the patient?
2. Is the nocturia in the patient?
3. Have there been obtained any data suggesting pollakiuria?

№ 3

Patient P., 39 years, was admitted to the renal center in a severe precomatous condition: there was marked weakness, apathy, the pain in muscles and joints, itching, the ammoniac smell from the mouth. It is found out, that she has been suffering from renal diseases since 26 years. Objectively determined are: edemas on the feet, face and congested enlarged liver. BP — 190/120 mm Hg. Residual blood nitrogen — 148 mmol/l. Glomerular filtration by endogenous creatinine — 12.0 ml/min. Zimnitsky test: in diurnal diuresis of 360 ml the fluctuation of relative density is 1.003–1.007.

Questions:

1. What type of renal insufficiency and what stage are there in the patient?
2. Are there any signs of uremia in the patient?
3. Due to what substances has the residual blood nitrogen increased?

№ 4

In patient Z., 26 years, soon after she had suffered the flu, appeared aggravated edemas, olyguria, proteinuria, hematuria. The anamnesis made it possible to establish, that edemas, proteinuria, headache had been observed in the patient for several previous years.

The clinical-laboratory examination revealed: residual blood nitrogen — 57 mmol/l, urea — 16.6 mmol/l, plasma creatinine — 200 μ mol/l. Glomerular filtration by endogenous creatinine — 28 ml/min. Zimnitsky test: fluctuations of relative urine density — 1.003–1.008 in diurnal diuresis — 350 ml.

Questions:

1. What type and what stage of renal insufficiency are there in the patient?
2. How can you explain the decrease of glomerular filtration in this type of insufficiency?

№ 5

Patient B., 30 years, was accidentally transfused 150 ml of blood of a wrong group. A typical picture of hemotransfusional shock, expressed anuria developed. At once an intensive anti-shock therapy was started: exchange blood transfusion, hemodialysis. Gradually the patient's condition improved. For the 8th day from the moment of shock the patient excreted 4.5 l of light urine, the relative density of which made up 1.008–1.012. The urine contains a lot of protein, erythrocytes, leukocytes, epithelial cells. Residual blood nitrogen — 34 mmol/l, urea — 12 mmol/l.

Questions:

1. What type and what stage of renal insufficiency are there in the patient?
2. What is the mechanism of polyuria in this case?

№ 6

Patient F., 26 years, was delivered to hospital with profuse gastric bleeding in a severe condition. BP — 80/60 mm Hg. The patient excretes 160–180 ml of urine a day. Residual blood nitrogen — 62 mmol/l, blood urea — 36 mmol/l, creatinine — 260 μmol/l.

Questions:

1. What type and what stage of renal insufficiency are there in the patient?
2. How can you explain the reduction of diuresis in the patient?

№ 7

The examination of the secretory function of the patient revealed: diurnal diuresis comprises 2 l in the relative urine density fluctuation from 1.008 up to 1.030. No protein, glucose, leukocytes, erythrocytes are present in the urine.

Residual blood nitrogen is 84 mmol, nitrogen of serum amino acids — 0.3 g/l, urea content — 1.5 mmol/l, creatinine — 44 μmol/l, uric acid — 0.15 mmol/l.

Questions:

1. Do the listed parameters testify to the development of renal insufficiency?
2. What is a possible mechanism of azotemia in this case?

№ 8

The present disease of patient H., 45 years, began 8 years ago with pains in the lumbar area, moderate edema of extremities. 5 years later an exacerbation of the disease took place with the same symptoms. Subsequently he was practically healthy. Now he is hospitalized due to deterioration of general condition.

The urine analysis on admission: a yellow color, acid reaction, protein — 0.6 g/l, glucose is absent. In the deposit: a moderate amount of epithelium, leu-

kocytes — 10–15 in the field of vision, erythrocytes — single in the preparation, cylinders — hyalinous, waxlike, granular — 2–3 in the field of vision. Zimnitsky test: urine relative density — 1.010–1.016 in diurnal diuresis of 860 ml. In the blood: urea — 9 mmol/l, creatinine — 115 μ mol/l.

Questions:

1. What pathological changes are revealed by the patient's urine analysis?
2. Are there any data suggesting the impairment of glomerular filtration?
3. Are there any data suggesting the impairment of concentration ability of the kidneys in the patient?

№ 9

After overcooling the patient, 24 years, acquired a sharp disease. Complains of general weakness, edema of the face, headache, breathlessness on the slightest exertion.

The urine analysis: a red-brown color, turbulent, acid reaction, protein — 1.2 g/l, glucose is absent. In the deposit: epithelium in a moderate amount, leukocytes — 3–8, erythrocytes — 20–40–100, cylinders hyalinous — 0–2 in the field of vision, urates, uric acid. Zimnitsky test: urine relative density — 1.012–1.031 in diurnal diuresis of 780 ml. Endogenous creatinine clearance — 56 ml/min.

Questions:

1. What pathological components of urine are revealed in the patient?
2. What features testify to the impairment of filtration ability of the kidneys?
3. What is a possible impairment mechanism of the kidneys filtration ability in this case?
4. Are there any features testifying to the impairment of the kidneys concentration ability?

№ 10

Patient K., 3 years, complains of early fatigue, constant feeling of hunger and thirst. No objective changes on the part of internal organs are present.

Zimnitsky test: relative density fluctuations of urine — 1.020–1.038 in diurnal diuresis of 3 l. Daily excretion of glucose with urine is 1.2 g, the degree of glucosuria being identical in diurnal and nocturnal portions. Blood glucose — 3 mmol/l. The Glycemic curve on sugar loading or introduction of insulin is normal. While examining a brother, 1.5 years, a permanent glucosuria is also revealed.

Question: What renal function is also impaired and what is a possible mechanism of glucosuria in this case?

№ 11

Patient M., 16 years, was knocked down by a car. He was delivered to hospital in the condition of a severe shock. There were multiple fractures of both legs. BP — 80–60 mm Hg.

He excretes 60–80 ml of urine a day. In urine: protein — 0.66 g/l, urine relative density — 1.029. Residual blood nitrogen — 120 mmol/l, blood urea — 35 mmol/l.

Questions:

1. What is the mechanism of anuria in the patient?
2. To which of the known pathogenetic variants is anuria, developed in the patient, referred?

№ 12

A rabbit was intravenously injected a heterologic (duck) anti-renal serum. The developed kidney damage was accompanied by hypertension, edema, proteinuria, hematuria. On morphological examination of kidneys an expressed picture of glomerulonephritis was established.

Questions:

1. What development mechanisms of glomerulonephritis are revealed by the given model?
2. Of what renal syndrome is the above semiology characteristic?

№ 13

On daily injection of 0.8 ml of 1 % sublimate solution to rabbits within 5 days there develops an expressed oliguria, proteinuria, hypoproteinemia, glomerular filtration being 90 % of the norm.

Question: How can you explain the development of expressed oliguria on the background of an insignificant reduction of glomerular filtration?

№ 14

The renal function of patient I., 35 years, was examined with the purpose of preparing him for operation.

The urine analysis: a light yellow color, transparent, acid reaction. Protein — traces, glucose — 10 g/l. In the deposit: single epithelium, leukocytes — 0–2, erythrocytes — 0–1 in the field of vision. Zimnitsky test: urine relative density fluctuations 1.034–1.050, in diurnal diuresis of 3.8 l. Residual blood nitrogen — 15.2 mmol/l, urea — 3.2 mmol/l, plasma creatinine — 44 μmol/l.

Questions:

1. What is a possible development mechanism of polyuria in the patient?
2. What is the high urine relative density caused by in this case?

№ 15

Patient M., 58 years, was admitted to hospital with complaints of severe weakness, sharp chills, the pain in the lumbar area, the urine of a dark red color. From the anamnesis: the patient had been taking gentamycin for the last 8 days. From biochemical blood test: residual nitrogen — 300 μmol/l, creatinine — 175 μmol/l. The urine analysis: diurnal diuresis — 300 ml, urine of a dark-brown color, protein — 0.6 g/l. Leukocytes, erythrocytes — 1–2 in the field of vision.

The clinical diagnosis is made: acute renal insufficiency (ARI).

Questions:

1. Specify the causes of ARI. What was a possible development cause of ARI in the given patient?

2. Name the forms and ARI stages.
3. Explain the development mechanism of anuria in the renal form of ARI.
4. Is the restoration of renal functions possible in ARI?

№ 16

Patient H., 43 years, applied to the doctor with complaints of sharp weakness, breathlessness, headache, nausea. At the age of 20 years she suffered acute pyelonephritis.

Objectively: the skin is dry, pale, no edemas. BP — 160/100 mm Hg. The blood test: hemoglobin — 78 g/l, erythrocytes — $3.44 \times 10^{12}/l$, leukocytes — $7.2 \times 10^9/l$, ESR — 29 mm/h. The biochemical blood test: residual nitrogen — 52 mmol/l, creatinine — 312 mcmol/l. The urine analysis: diurnal amount — 2100 ml, acid reaction, relative density — 1.006, protein — 0.99 g/l, erythrocytes changed 5–7 in the field of vision, cylinders hyalinous and granular — 5–6 in the field of vision. The clinical diagnosis: chronic renal insufficiency (CRI).

Questions:

1. What causes result in CRI?
2. Explain the development mechanisms of CRI.
3. What changes occur in the systems of the organism (CNS, cardiovascular, GIT)?
4. Explain the development mechanism of renal osteodystrophy (osteomalacia, osteoporosis)?

Additional information

Distinguish four stages of the clinical course of CRI: latent, compensated, intermittent and terminal (according to N. A. Lopatkin, I. N. Kuchinsky, 1973)

Table 2

Stages of CRI (pre-uremic)

Clinical-laboratory features	Latent	Compensated	Intermittent
Complaints	None	Dyspepsia, dryness in the mouth, fatigue	Weakness, headache, sleep impairment, thirst, nausea
Diuresis	Within the normal limits	Light polyuria	Expressed polyuria
Hemoglobin, g/l	Over 100	83–100	67–83
Ziminsky test	The norm	The difference between the maximum and minimum urine density is less than 8	Hypoisostenuria
Blood urea, mmol/l	Up to 8.8	8.8–10	10.1–19.0
Blood creatinine, mcmol/l	Up to 180	200–280	300–600
Glomerular filtration by creatinine, ml/min	45–60	30–40	20–30
Urine osmolarity, mosmol/l	450–500	Up to 400	Less than 250

Blood electrolytes	Within the normal limits	Seldom hyponatremia	Frequently hyponatremia, hypocalcemia
Metabolic acidosis	None	None	Moderate

The terminal stage periods

(I) The water-secretory function of the kidneys is preserved. The clearance is sharply reduced: up to 10–15 ml/min. Azotemia 71–107 mmol/l with a tendency to growth. Acidosis is moderate; water-electrolyte impairments are not present.

(IIA) Oligo-, anuria, retention of fluid, dyselectrolythemia, hyperazotemia, acidosis. Reversible changes on the part of the cardiovascular system and other organs. Arterial hypertension. Blood circulation insufficiency on IIA stage.

(IIB) The same data as in IIA period, but a more severe cardiac insufficiency with blood circulation impairment in the general and pulmonary circulations on IIB stage.

(III) Severe uremia, hyperazotemia (285 mmol/l and higher), dyselectrolythemia, decompensated acidosis. Decompensated cardiac insufficiency, attacks of cardiac asthma, anasarca, severe dystrophy of the liver and other internal organs.

Table 3

Factors of the total urine analysis in norm

Factor	Factor value
Diurnal amount, ml: (female) (male)	600–1600 800–1800
Relative density (morning portion)	1008–1026
Osmolarity, mosmol/kg	500–1400
Color	Straw-colored
Clearance	Clear
PH	4.5–8.0
Titrated acidity, mmol/d	20–40
Protein	Is absent or traces (<100 mg/day)
Glucose	No
Acetone	No
Ketonic bodies, mg/flat	0–50
Bilirubin	No
Hemoglobin	No
Urobilin, mg/day	0–6
Erythrocytes	0–4 in the field of vision in fresh centrifuged urine
Leukocytes: (male) (female)	0–3 in the field of vision 0–6 in the field of vision
Renal epithelium (cylindrical)	No
Epithelium of urinary ways (flat)	Insignificant amount
Cylinders	No
Mucus	Insignificant amount
Bacteria	No more than 50000 in 1 ml
Salts	Insignificant amount — urates in acid pH urine);

phosphates (in alkaline pH urine); uric acid ammonium, oxalates.
--

The glomerular filtration rate (GFR) by creatinine: 125–130 ml/min (male); 110–115 ml/min (female).

LESSON 16. PATHOLOGICAL PHYSIOLOGY OF THE NERVOUS SYSTEM. IMPAIRMENTS OF SENSOR AND LOCOMOTOR FUNCTIONS

SITUATIONAL TASKS

№ 1

Patient E, 28 years, was admitted to the neurological clinic with complaints for slight (fine) tremor of extremities and the head at rest. Mimics and jests are absent. She stares at one point. Voluntary movements are made slowly. The speech fades away and turns into unclear bubbling. The patient moves as a mannequin, making small steps without the appropriate movements of the trunk and arms, is depressed, becomes tired quickly. When walking, the tremor is considerably decreased unless it disappears.

Questions:

1. What syndrome (disease) developed in the patient?
2. Explain the underlying mechanisms.
3. Name the type of tremor.

№ 2

There are observed quick arrhythmic involuntary movements of extremities and the trunk in patient D., 7 years. He grimaces, smacking his lips, often shows the tongue. The muscular tone of extremities is decreased.

Questions:

1. What is the described syndrome called?
2. What brain structures are impaired?

№ 3

In patient K., 53 years, active movements of the left leg are absent; the tone of the leg extensors is increased. The knee and ankle reflexes on the left are higher than those on the right, abdominal reflexes on the right are absent. Pathological Babinski's reflex is produced on the left. From the level of nipples downwards the sensitivity to pain and temperature is lost, on the left is lost a tactile, muscular-articular and vibration sensitivity.

Questions:

1. With the impairment of what structures of the nervous system is the described semiology associated?
2. What is the name of such a syndrome?
3. Explain the pathogenesis of the above symptoms.

№ 4

Patient L., 62 years, complains of extremely early fatigue (asthenia). On examination there was revealed scanned speech, horizontal nystagmus, staggering («drunken») gait, instability in Romberg's test. Co-adjointing movements (asynergy) are absent, the muscles of extremities are hypotonic. A constant tremor and swaying of the trunk and extremities are noted (astasia). The coordination of movements is impaired (ataxia).

Question: Prove your suggested diagnosis.

№ 5

Patient K., treated in the neurological clinic, is noted to have lost the pain and temperature sensitivity in the lower part of the body and the muscular-articular feeling in the right leg.

Question: What can be said regarding the syndrome and mechanism of its origin?

№ 6

A girl, 10 years, applied to the doctor with complaints of a constant involuntary twitching of the right eye lid.

Questions:

1. Name the type of pathology.
2. What are the possible mechanisms of its origin?

№ 7

A patient of 55 years applied to the doctor with complaints of restriction of active movements in the left arm and leg. On examination of the patient the restriction of voluntary movements in the specified extremities is marked. The muscular tone and periosteal reflexes of the specified extremities are increased.

Questions:

1. Name the impairment form of the movement function.
2. Explain the mechanism of muscular tone elevation and hyperreflexia of impaired extremities.

№ 8

A patient of 60 years applied to the doctor with complaints of rigidity of movements, a mask-like face, amimicity, finger tremor as «rolling pills». The tremor disappears on performing movements.

Questions:

1. Name the type of pathology.
2. What are the possible mechanisms of its origin?

№ 9

A patient of 50 years applied to the doctor with complaints of restriction of voluntary movements in the left arm and leg. A year before he had suffered cerebral hemorrhage. On examination his left arm is flexed and abducted to

the trunk, his left leg is sharply straightened. The muscular tone and periosteal reflexes of the specified extremities are increased. There are pathologic reflexes.

Questions:

1. What can you say regarding the available impairments?
2. What is the mechanism of their origin?

№ 10

In a girl of 12 years, after she had suffered an infectious disease, appeared clonic spasms of various intensity that constantly change the place of their localization. As a result of alternately twitching movements of the arms, head and trunk the adaptive reactions of the organism are sharply restricted.

Question: Name the type of hyperkinesia and specify the possible mechanisms of its origin.

№ 11

After the impairment of cerebral circulation in patient T., 56 years, he developed a spastic muscular contraction of the right arm and right leg. The muscular tone of these extremities is increased. Voluntary movements of these extremities are impossible, and tendon and periosteal reflexes are increased. Muscular atrophy is not noted.

Questions:

1. Specify the form of akinesia in this patient.
2. Explain the mechanism of muscular tone elevation, tendon and periosteal reflexes.

№ 12

A patient of 58 years applied to the doctor complaining that some tremor occurred on bringing a glass of water to the mouth, on an attempt to take some thing from the table or shelf; tremor swings increasing on approaching to the target.

Questions:

1. Name the type of hyperkinesia and possible mechanisms of its origin.
2. What is the difference between manifestations of intentional tremor and Parkinsonian one?

№ 13

A patient of 30 years applied to the doctor complaining that after a trauma of the back surface of the right hip, active movements in this extremity became sharply restricted, muscular atrophy of the leg appeared. On examination, alongside with muscular atrophy, the absence of the Achilles tendon reflex is noted.

Question: Name the impairment form of the motor function of the nervous system and specify its possible mechanism.

№ 14

In the patient treated in the neurological clinic occurred a spasm of a 3-minute duration with the first phase of tonic generalized and second phase of clonic generalized spasms.

Question: Name the form of spasms.

№ 15

On admission to clinic patient Ch., 23 years, a post-graduate of the university, presented multiple complaints of: bad sleep, irritability, tearfulness, absence of appetite, unstable mood, headaches.

Objectively: the somatic status is without deviations from the norm. The anamnesis revealed that specified on admission phenomena had been developing for the last 10 months. During this period the patient suffered a rather difficult situation: a failed marriage and the necessity to leave for a place of appointment (she didn't want to do something because she was not sure in her abilities as well as she was afraid to lose the connection with her husband). While staying in the department she constantly made faults with the personnel, demanded special attention. After every meal vomiting occurred (often in the presence of patients and personnel).

Questions:

1. What is the origin of a symptomatic complex developing in the patient?
2. In what type of HNA do similar impairments develop more often?

№ 16

Patient C., 42 years, was brought up in the family, the main task of which was to achieve a success in life and position in the society. He studied with great difficulty. Under the demand of his parents he tried to be a top schoolboy paying much effort. After school (by wish of his parents) he entered the institute. The studies at the institute demanded even more efforts. He studied much, sometimes at night. On graduation from the institute he started working at a plant as a shift master. As soon as the post of the chief of the shop became vacant, he applied for it, though the profile of the shop did not correspond to his acquired specialty. Besides, by that time his management experience was not sufficient. Having become the chief of the shop he faced great problems. The shop under his management stopped performing the production tasks, it resulted in reprimands and critics on the part of the administration and the collective of the shop.

It is in this period that he developed head aches, painful sensations in the heart area, sleeplessness, irritability, early fatigue, his workability sharply decreased.

Objectively: BP — 170/90 mm Hg, pulse — 90 beats per minute, Focal neurological symptoms were not revealed.

Questions:

1. What was the cause of appearing pains in the heart area, tachycardia and arterial hypertension?
2. What form of nervous system pathology developed in this patient?

LESSON 17. PATHOPHYSIOLOGY OF THE ENDOCRINE SYSTEM

SITUATIONAL TASKS

№ 1

Patient K., 37 years, was admitted to clinic with complaints of severe palpitation, weakness, sweating, irritability, anxiety, sleep impairment, decrease of workability. On examination of the patient the following was revealed: intense glitter of the eyes, exophthalm; tremor, subfebrilitis; an increase of T_3 , T_4 in the blood, total iodine and iodine bound with protein; the content of residual nitrogen in the urine is increased; basic metabolism is increased.

Questions:

1. The function of what endocrine gland is impaired in the patient?
2. What is the name of this disease?

№ 2

Patient I., 27 years, complains of headache, thirst, frequent and profuse urination, diurnal diuresis — 6.5 l. On examination: the pulse — 72 beats/min, BP — 135/98 mm Hg. The following is revealed in the patient: the relative density of urine — 1.009; sugar in urine is absent. In the plasma: sodium — 140 mmol/l, potassium — 4.3 mmol/l.

Questions:

1. The function of what endocrine gland is impaired in the patient?
2. What is the name of this disease?

№ 3

Patient M. was admitted to clinic with complaints of terminal paralyses, sensation of parasthesia, increased thirst. The examination of the patient revealed: BP — 160/110 mm Hg, hypokalemia, diurnal urine excretion — 6 l, the content of aldosterone in the urine is increased.

Questions:

1. The function of what endocrine gland is impaired in the patient?
2. What is the name of this disease?
3. Why is this disease, unlike secondary hyperaldosteronism, characterized by polyuria and not by an edematous syndrome?

№ 4

Patient I., 41 years, was admitted to clinic. 2 years ago she suffered a severe flue. She complains of the absence of appetite, frequent headaches, listlessness, sleepiness. The examination of the patient revealed: sharp exhaustion, elderly air; BP — 100/80 mm Hg; a decreased content of follitropin, 17-ketosteroids in urine; tropin, somatotropin and corticotropin are absent in blood.

Questions:

1. The function of what endocrine gland is impaired in the patient?
2. What is the name of this disease?

№ 5

Patient Z., 25 years, was admitted to clinic with complaints of growing whiskers and beard, impairment of a menstrual cycle. The examination revealed: the skin is thin and dry, expressed obesity of the trunk; BP — 150/95 mm Hg. The ultrasound examination findings: bilateral hypertrophy of adrenal glands. The level of ACTH is 1.8-fold increased.

Questions:

1. The function of what endocrine gland is impaired in the patient?
2. What is the name of this disease?
3. List the main clinical forms of this disease.
4. What form of the disease is in this patient?

№ 6

Patient I., 26 years, was admitted to clinic in an unconscious state. According to her husband, after the flu the patient developed thirst, loss of weight, poor appetite, pains in the abdomen, weakness, head ache.

On the eve she developed a pain in the abdomen, recurrent vomiting, and confused consciousness. On examination: the consciousness is absent, respiration of Kussmaul, acetone smell from the mouth, signs of dehydration — the skin is dry, pale, cold, the tongue is coated with a brown film. The pulse — 120 beats/min; of slight filling and tension; BP — 95/60 mm Hg. The abdomen is soft, tenderless; the blood sugar level — 21 mmol/l, hyperketonemia, pH of the blood — 7.0.

Questions:

1. What disease can be suggested?
2. Characterize the state of the patient on admission.
3. What pathogenesis of hyperketonemia is in this pathology?
4. List the main pathogenesis components of a coma in this pathology?

№ 7

Patient K., 45 years, was admitted to clinic with complaints of general weakness, difficulty while walking, a creepy feeling on movement, pain in the abdomen, diarrhea, thinning, absence of appetite, nausea, pains in the back. On examination it was revealed: on X-ray film — diffuse osteoporosis; the level of inorganic phosphorus in the blood is reduced, the calcium content in the blood is increased; hematuria, albuminuria, hypercalciuria, hyperphosphaturia.

Questions:

1. The function of what endocrine gland is impaired in the patient?
2. What is the name of the disease?

№ 8

In patient D., 43 years, the computer tomography revealed the enlargement of the hypophysis dimensions, on ultrasound examination — a bilateral enlargement of adrenal glands with hyperplasia of the cortical layer. The state on admis-

sion: obesity, «moon-like» face, girsutism, purple scars on the skin of the hips, BP — 190/95 mm Hg, blood glucose content — 18.9 mmol/l, glucozuria.

Questions:

1. The function of what endocrine gland is impaired in the patient?
2. What is the name of the disease?
3. The clinic pictures of patient U. and patient D. being the same, the ultrasound examination of patient U. revealed hyperplasia of one adrenal gland and a low level of ACTH in the blood. What is the name of the disease in patient U.?
4. Why was a low blood level of ACTH revealed in patient U.?

№ 9

Patient B., 36 years, was admitted to clinic in an unconscious state. When at home, the patient developed a psychic and motor excitation followed by a loss of consciousness. According to neighbors, the patient had been suffering from diabetes mellitus for many years, was treated with insulin and ate irregularly due to constant business trips.

On examination: consciousness is absent, the skin is wet, twitching of face muscles is noted, the pupils are dilated; respiration rate — 32 resp./min, pulse — 70 per min, rhythmic, BP — 130/80 mm Hg; blood glucose level — 2.45 mmol/l.

Question: What is the name of the state developed in the patient?

№ 10

A woman, 30 years, after a massive loss of blood during deliveries followed in 2 hours by hemotransfusion, developed a progressive thinning, atrophy of skeletal muscles, dystrophic changes of the skin, loss of hair and teeth, hypotrophy of internal organs, decrease of body temperature. On admission it was revealed: BP — 95/55 mm Hg; blood glucose level — 3.75 mmol/l.

Question: What pathology is characterized by specified manifestations?

№ 11

Patient A., 26 years, applied to the doctor with complaints of general weakness, headaches, changing of the appearance, enlargement of hands and feet. His shoe size enlarged from 39 to 42 within 2 years.

Objectively: the enlargement of the face features is marked (massive superciliary and cheek arches, a large nose, lips). A barrel-shaped chest, clavicles are thickened; hands and feet are enlarged in size. No essential changes on the part of internal organs are revealed. The pulse — 70 per min, BP — 150/90 mm Hg.

Questions:

1. On the excess or insufficiency of what hormone are similar changes marked?
2. What is this disease called, what is its etiology?

№ 12

Patient K., 14 years, was admitted with complaints of early fatigue, poor appetite, nausea, darkening of the skin.

The parents associate her disease with scarlet fever she has suffered half for a year ago, when early fatigue, listlessness, apathy, decrease of appetite appeared. She eats with pleasure only salty food. Lately the parents noted darkening of the skin integuments.

Objectively: Marked asthenia is noted. BP — 95/55 mm Hg. Muscular strength is attenuated. The skin is swarthy, of a golden-brown color, some pigmentation being more intense on the neck, face, hands. There is a dark fringe on the mucous membrane of the gums. No substantial deviations from the norm on the part of internal organs are present.

Questions:

1. What endocrine pathology is characterized by these symptoms?
2. Explain the development mechanism of hyperpigmentation of the skin.
3. Explain the development mechanism of arterial hypotension in this case.
4. How can you explain the preference of salty food by the child?
5. What diet should be recommended to the patient: rich in salts of sodium or potassium?

№ 13

Patient A., 37 years, was admitted to clinic with complaints of listlessness, sleepiness, depressed mood, poor memory, frequent headaches, constipation, impairment of the menstrual cycle. For the last half a year she gained much weight despite poor appetite. She constantly feels cold. The examination revealed: the patient with signs of moderate obesity, the face is puffy, amimic, the lids are edematous, movements are flaccid. The pulse — 54 beats per min. The body temperature — 35.4 °C. The basic metabolism is reduced by 27 %. The blood cholesterol content — 6.8 mmol/l; glucose level — 3.9 mmol/l.

Question: What pathology of the endocrine system can be suggested?

№ 14

Patient K., 48 years has been suffering from bronchial asthma for 30 years. The complex treatment of asthma used preparations of glucocorticoids, further on the patient took them independently for several years. During this time obesity developed. BP became elevated up to 190/110 mm Hg. Some days after he discontinued the preparation by himself there appeared sharp weakness, his appetite disappeared, diarrhea appeared. Due to the presence of these symptoms he was delivered to hospital.

On examination: the patient of middle height, obesity with predominant fat deposit in the area of the face and abdomen, the extremities being thin. There are purple strips of tension on the abdomen, much acne on the face and back. BP — 70/50 mm Hg, blood glucose level — 2.7 mmol/l.

Questions:

1. What pathology of the endocrine system can be suggested?

2. Why did hypotension and hypoglycemia develop after discontinuation of glucocorticoids?

№ 15

Patient V., 39 years, was hospitalized to the neurosurgical department by the first aid after he fell flat on his back trying to get up at night.

On examination: the patient is not contacted, profuse cold perspiration, clonic spasms, asymmetry of the face, tendon reflexes are increased, Babinski symptom is positive. In the reception ward a subarachnoidal hemorrhage was suggested. The severity of the patient's condition increased: convulsions, hyperreflexia started to come into ascending paresis of muscles, areflexia, the respiration rhythm was impaired. To prevent the involvement of the brain stem the patient was perfused 40 ml of 10 % solution of glucose and started a droplet injection of mannitol, giving an unexpectedly positive effect that disappeared and recovered on additional injection of glucose. After a massive infusion of glucose the patient recovered his consciousness. According to his words, he was having such attacks for the last year, they occurred after physical exertion or emotional stresses, the severity of stresses becoming gradually worse. At first they showed as shivering, weakness, dizziness, sweating and feeling of hunger; during the last 2 months the attacks were accompanied by a short-term loss of consciousness.

Question: What is your suggested diagnosis?

№ 16

Patient Sh., 52 years, soon after strumectomy, felt muscular spasms of hands, numbness of the face. The spasms recurred 2-3 times during a day.

On examination: the general condition is satisfactory. The pulse — 76 per min, BP — 110/70 mm Hg. No pathologic changes in the internal organs are revealed. Positive symptoms of Khvosteck and Trusso.

Question: What complication occurred after strumectomy?

№ 17

What symptoms are characteristic of diabetic ketoacidosis (A) and hypoglycemic state (B):

- 1) pain in the abdomen;
- 2) nausea;
- 3) vomiting;
- 4) feeling of hunger;
- 5) absence of appetite;
- 6) disorientation;
- 7) anxiety;
- 8) shivering;
- 9) apathy;
- 10) indifference;
- 11) dryness of the skin;
- 12) wetness of the skin;

- 13) usual respiration;
- 14) deep respiration;
- 15) the skin and muscles are flabby;
- 16) pupils are narrowed;
- 17) pupils are dilated;
- 18) tachycardia;
- 19) arterial hypotension;
- 20) hypo-, areflexia;
- 21) hyperketonemia;
- 22) hyperglycemia;
- 23) acetonuria;
- 24) hypoglycemia;
- 25) alkaline blood reservoir is normal;
- 26) alkaline blood reservoir is decreased.

ANSWERS TO SITUATIONAL TASKS

LESSON 1. ACUTE CARDIAC INSUFFICIENCY. CORONARY INSUFFICIENCY.

№ 1

1. Fatty embolism of the pulmonary artery due to a fracture of the femoral bone.

2. By the origin — overstress (overstress by pressure); by the course — acute; by localization — right-ventricular.

3. The clinical picture is caused by the sum of two basic syndromes: 1 — stasis in the inflow ways to a weakened department of the heart (congestion signs in the general circulation: sharp swelling of cervical veins, enlargement of the liver); 2 — a small output with hypoperfusion of the pulmonary circulation (cyanotic skin integuments, arterial hypoxemia (oxyhemoglobin content in arterial blood — 85 %, tachypnae, arterial hypotension (BP — 85/60 mm Hg).

№ 2

1. Yes, there is. By the origin it is myocardial insufficiency caused by an ischemic damage of the myocardium.

2. The basic mechanism of compensating the hemodynamics impairments in this patient is tachycardia. Its efficiency is not high, besides, tachycardia further aggravates the energetic supply of the myocardium.

3. The basic syndrome is the stasis in the inflow ways to the weakened department of the heart (left ventricle); clinically it is manifested by cardiac asthma and cardiogenic edema of the lungs.

№ 3

1. Acute left-ventricular insufficiency and/or pneumonia.
2. Decrease of the cardiac output and cardiac index, prolongation of the phase of isometric tension, phase of discharge and increase of the final diastolic pressure in the left atrium and left ventricle, increase of the pressure in the system of the pulmonary artery.
3. Acute left-ventricular insufficiency. It may develop due to:
 - a) overstrain of the myocardium by the volume due to insufficiency of the mitral valve in disruption or dysfunction of the papillary muscle;
 - b) ischemic damage of the myocardium;
 - c) combined action of the specified factors.

№ 4

1. Myocardial infarction.
2. ECG data specify localization of the infarction in the anterior wall of the left ventricle.
3. By release («leakage») of these enzymes from altered cardiomyocytes.
4. Syndromes: acute cardiac insufficiency, pain, resorption-necrotic.
5. Circulation impairment of cardiomyocytes (ischemia) as a result of, most probably, thrombosis of coronary arteries.

№ 5

1. Consequences of ion imbalance in cardiomyocytes in acute coronary insufficiency.

Changes of intra- or extracellular ion concentration	Basic pathophysiologic correlates
Increase of intracellular Ca^{2+} concentration	<ol style="list-style-type: none"> 1. Activation of Ca-dependent proteinases, lipases, phospholipases, LP processes → damage of membranes including mitochondrial → aggravation of energy deficiency. 2. Ischemic and post-ischemic contracture → diastolic dysfunction. 3. Impairment of intracellular regulation of metabolism
Increase of intracellular Na^+ concentration	<ol style="list-style-type: none"> 1. Intracellular edema, swelling of organelles, osmotic damage and micro-ruptures of membranes. 2. Impairment of bioelectrogenesis → arrhythmogenic effect
Decrease of intracellular K^+ concentration and increase of extracellular K^+ concentration	<ol style="list-style-type: none"> 1. Impairment of formation of the membrane potential at rest, decrease of the depolarization threshold → arrhythmia incidence. 2. Local increase in the ischemia zone → elevation of ST-segment
Increase of intracellular H^+ concentration	<ol style="list-style-type: none"> 1. Contest with Ca for the sites of linkage with troponine C → depression of myocardium contractility → systolic dysfunction. 2. Activation of proteolysis → destruction of myofibrils, modification of enzyme activity. 3. Depression of a key enzyme of glycolysis — phosphofructokinase → depression of glycolysis → aggravation of energodeficiency. 4. Excitation of chemoreceptors due to increase of H^+ in the extracellular environment → pain syndrome

2. The basic cause of ion imbalance — is the energy deficiency in a cardiomyocyte and consequently the impairment of functioning of ion pumps.

№ 6

1. Pathogenesis of breathlessness in the left-ventricular insufficiency: congested phenomena in the pulmonary circulation → excessive transudation of fluid into the pulmonary interstitium → aggravation of pulmonary elasticity → excessive activity of respiratory muscles on an inhalation → feeling of difficult breathing and insufficiency of air (breathlessness).

2. Sedentary position with legs down decreases the mass of circulating blood, the inflow of blood to the pulmonary circulation and the heart. All these contribute to a decrease of blood stasis in the lungs and improve pulmonary ventilation.

№ 7

1. IHD: sudden coronary death due to fibrillation of ventricles.

2. The doctor made 2 mistakes: didn't take urgent measures to control a pain syndrome; in the development of ventricular fibrillation he shouldn't have injected preparation i/v, as in the absence of adequate hemodynamics it gives no therapeutic effect. After controlling the pain syndrome it is necessary either to perform an electric defibrillation or inject the preparation intra-cardially.

№ 8

1. IHD: acute myocardial infarction in the area of the anterior-lateral wall of the left ventricle, cardiogenic shock.

2. Reflector cardiogenic shock (collapse); true cardiogenic shock; areactive shock; arrhythmic cardiogenic shock.

LESSON 2. CHRONIC CARDIAC INSUFFICIENCY

№ 1

1. Manifestations of cardiac insufficiency: breathlessness, palpitation, pain in the heart area, cardiomegaly, decrease of the stroke volume, hemoptysis, edemas of feet, enlargement of the liver, cyanosis, moist râles in the lungs.

2. Pathogenesis of these symptoms is caused by insufficiency of the cardiac function resulting in the decrease of the stroke and minute volume as well as congestive phenomena in general (edema of feet, enlargement of the liver) and pulmonary circulation (breathlessness, hemoptysis, moist râles in the lungs). **Cardiac cyanosis** is caused by an increased extraction of oxygen and entrance of carbon dioxide to the venous end of capillaries due to total venous stasis. As a result the venous blood contains a smaller, than in norm, amount of oxy-

hemoglobin and is **excessively enriched with carboxyhemoglobin** that gives it a characteristic cyanotic shade. Cardiac cyanosis is a peripheral (venous), cold, acrocyanosis.

3. Changes in the central hemodynamics (tachycardia, increase of CBV (circulating blood volume) as well as erythrocytosis caused by triggering of compensatory mechanisms (hyperactivation of the sympathetic-adrenal, rennin-angiotensine-aldosterone system, hyperproduction of erythropoietine), that are triggered, in particular, due to developing hypoxia.

№ 2

1. The patient developed a nocturnal paroxysmal breathlessness — cardiac asthma. The direct cause of cardiac asthma is the left-ventricular insufficiency. The mechanism of its development — overloading of the cardiac ventricle by tension (as the patient suffers from arterial hypertension). The occurrence of an acute attack of asthma at night (in the supine position) could be caused by re-distribution of blood from the general into pulmonary circulation and as a result a decrease of the contractile function of the ventricle. It resulted in the stasis in the pulmonary circulation and an attack of inspiratory breathlessness («asthma»).

2. The basic functional impairment mechanism of the hypertrophied left ventricle on its overloading consists in the imbalance between the enlargement of myofibrils mass and growth inhibition of the amount of mitochondria, endoplasmatic net, capillaries; reduction of the ratio of the surface and volume of a cardiomyocyte.

3. Principles and methods of correcting cardiac insufficiency.

Purposes	Examples of medical drugs
Reduction of hemodynamic loading on the myocardium	
1. To reduce post-loading (↓ the tone of resistant vessels). 2. To reduce pre-loading (↓ the size of venous return of blood to the heart)	Vasodilators (alpha-adrenoblockers, blockers of calcium channels, APF inhibitors, blockers of angiotensin II receptors), venous vasodilators (nitrates), diuretics
Elevation of a contractile function of the myocardium (in some forms of cardiac insufficiency, more often — in an acute one)	
To raise the contractility of the heart	Adrenomimetics, cardiac glycozides, inhibitors of phosphodiesterase
Damage reduction of the myocardium	
1. Deficiency reduction of energy supply for cardiomyocytes. 2. Protection of membranes and enzyme systems against damage. 3. Imbalance decrease of ions and water in a cardiomyocyte. 4. Correction of adreno- and cholinergic effects on the heart. 5. Decrease of cardiotoxic and remodeling	Antihypoxants, antioxidants, coronary dilators, medical drugs with a membrane-protector effect, regulators of ion transport (potassium sparing diuretics, blockers of calcium channels, preparations of magnesium), beta-adrenoblockers, APF inhibitors

№ 3

Under these conditions the exhaustion will sooner occur in animals with the most expressed hypertrophy of the myocardium, as the hypertrophy of the myocardium, as well as any compensatory reaction, possesses a relative expediency. The hypertrophied heart differs from the normal one with a number of structural, metabolic and functional features, which reduce its functional reserves, reduce the range of adaptation opportunities and make it more «vulnerable» in various unfavorable situations.

№ 4

No, it won't, as the basis of long-term adaptation of the heart to increased loadings is the hypertrophy of the myocardium as a result of activation of the genetic system of myocardial cells and consequently — activation of proteins synthesis. Aktinomycine D blocks the protein synthesis and thus prevents the formation of hypertrophy of the myocardium.

№ 5

1. The child has a mixed (myocardial + overloading) type of cardiac insufficiency.
2. Dilation of the left heart border is caused by dilatation of the left ventricle and has a compensatory character.
3. In this case the overloading with volume takes place.

LESSON 4. PATHOPHYSIOLOGY OF THE CIRCULATION SYSTEM

№ 1

- 1, 3, 4, 6, 7, 8, 10, 11, 12, 13, 14, 15.
- headache, dizziness, nausea — the consequence of elevation of intracranial pressure and irritation of brain membranes.
 - flashing of «flies» before the eyes, loss or deterioration of sight — the consequence of retina ischemia of an angiospastic origin.
 - shooting pain in the heart area, attacks of pain behind the breastbone — the consequence of hypoxia of the myocardium as a result of its overloading and/or ischemia of an angiospastic origin.
 - tachycardia — the consequence of hyperactivation of the sympathetic-adrenal system or hypoxia of the myocardium.

– breathlessness, attacks of asthma — congestion in the pulmonary circulation as a manifestation of the left-ventricular insufficiency due to its overloading with pressure.

– edemas can be the consequence of excessive fluid filtration at the arterial end of a capillary, when the systemic BP increases, on hyperactivation of the rennin-angiotensine-aldosterone system or congestion in the general circulation in an overloading form of cardiac insufficiency.

– impairment of cardiac rhythm can be a manifestation of hyperactivation of the sympathetic-adrenal and/or rennin-angiotensin-aldosterone systems, hypoxia of the myocardium or cardiosclerosis.

№ 2

For hypertension: 1, 3, 4, 5, 9, 11, 15.

For chronic glomerulonephritis: 1–14.

№ 3

1. The hypertensive disease (essential arterial hypertension).

2. Uncontrolled risk factors: male sex, age of 47 years, aggravated family anamnesis on cardiovascular pathology. Controlled risk factors: excessive body weight, chronic nervous-psychic stress, low physical activity, smoking, hypercholesterolemia, hyperglycemia (impairment of glucose tolerance (?)).

3. Normalization of the body weight and changing food habits, giving up smoking, regular physical exertion, reduction, whenever possible, of the expressiveness of emotional stress.

4. The brain, myocardium, kidneys, vessels.

№ 4

1. Presumably, pheochromocytoma — a tumor of the medullar substance of adrenal glands, excessively producing catecholamines.

2. Symptomatic arterial hypertension is caused by a positive inotropic and vasoconstrictive action of catecholamines.

№ 5

1. Regarding faints.

2. The faint in this case is caused by emotional stress resulting in imbalance of regulating effects on the part of sympathetic and parasympathetic nervous systems on hemodynamics with a decrease of sympathetic regulation and relative prevalence of the tone of a vagus nerve. It is a reflex vaso-vagal faint.

3. Principal causes of faints:

A. Reflector faints (vaso-vagal, visceral vago-vagal, the syndrome of a carotid sinus, orthostatic);

B. Cardiogenic (in particular, arrhythmogenic);

V. Faints in the stenosis of precerebral arteries.

№ 6

1. Regarding a collapse.

2. The collapse has developed due to acute vasodilatation and dropping of the total peripheral vascular resistance (TPVR) at a critical drop type of the body temperature in fever.

3. Kinds of collapses: orthostatic, hemorrhagic, infectious, endocrine, hyperthermal, pancreatic.

Major pathogenesis factors of a collapse: critical drop of BP can be caused by a decrease of: a) CBV; б) MBV; в) TPVR.

№ 7

1. $BWI = 32 \text{ kg/m}^2$; I degree of obesity.

2. An abdominal type of obesity.

3. Hyperglycemia on an empty stomach, impaired tolerance to glucose testifies to insulin resistance. Hypercholesterolemia, atherogenic dyslipoproteinemia.

4. A metabolic syndrome.

5. Diabetes of type II, arterial hypertension, IHD.

6. Abdominal obesity, arterial hypertension, insulin-resistance, atherogenic dyslipoproteinemia. The leading component of pathogenesis — insulin-resistance.

LESSON 5. PATHOPHYSIOLOGY OF THE EXTERNAL RESPIRATION SYSTEM. TYPICAL IMPAIRMENTS OF THE PULMONARY FUNCTION

№ 1

The patient has ventilation impairments of a restrictive type of a pulmonary origin.

№ 2

The patient has ventilation impairments of an obstructive type.

№ 3

1. A post-capillary form of hypertension due to the blood outflow impairment from the lungs in mitral stenosis can lead to the development of a pre-capillary form of hypertension as a result of triggering the reflex of Kitaev (a spasm of pulmonary arterioles in an increase of pressure in pulmonary veins).

2. Blood congestion in the lungs causes a decrease of their elasticity. As a rule, blood- and air-filling of the lungs are inverse related. The development of congestion in the pulmonary circulation results in decreasing of PC (pulmonary capacity) and, as a rule, TPC (total pulmonary volume).

3. The normal value of Tiffno's index testifies against the impairment of passability of respiratory ways of the patient. In this case ventilation impairments of the lungs of a restrictive type are observed.

№ 4

1. The insufficiency of external respiration of the patient is explained mainly by the impairment of gas diffusion through a thickened alveolar-capillary membrane.

2. The increase of tissue metabolism on physical loading requires an increase of the pulmonary ventilation volume. However because of the impairment of diffusion of gases, and first of all, oxygen, the usual increase of pulmonary ventilation cannot provide the organism with a necessary amount of oxygen. Therefore there occurs an excessive ventilation of the lungs, revealed in intensification of the activity of respiratory muscles. An increase of afferent pulsation from proprioception of respiratory muscles, strong excitation of receptors of alveoli stretching, chemoreceptors of vessels lead to an increase of excitation processes in the respiratory center and cause a further increase of pulmonary ventilation, while the formation of a sensation of difficult breathing (actually breathlessness) at a cortical level is provided by excessive afferentation from proprioceptors of muscles.

3. A test with any hyperventilation can aggravate hypoxemia in case of the impairment of diffuse abilities of the lungs.

№ 5

In this case a restrictive type of ventilation impairment of an extrapulmonary origin takes place.

№ 6

1. The patient has tachypnea. The basis of the tachypnea development is an increase of excitability of slowly adapting receptors of alveoli stretching, activation of juxtacapillary receptors, nonspecific receptors of parenchyma, and also collapse receptors in the zone of alteration under the influence of biologically active substances and hydrogen ions of exudate in this case. Pathological afferent pulsation is directed by the fibers of a vagus nerve into the bulbar respiratory center, raises excitability of expiratory (partly — inspiratory) neurons, that facilitates the development of Goering–Breyer's reflex and leads to frequent superficial respiration.

2. The decrease of blood oxygenation in this case is mainly explained by the impairment of oxygen diffusion.

№ 7

1. The reason of respiratory insufficiency in this patient is the impairment of diffusion of gases, first of all, oxygen through an alveolar-capillary membrane.

2. Hyperventilation represents increased muscular work of respiratory muscles and is accompanied by additional consumption of oxygen. In the impairment of oxygen diffusion, additional muscular work results in aggravation of imbalance between an increased need in oxygen and its delivery, thus to even greater arterial hypoxemia.

№ 8

1. No, it is impossible. Meningitic (Biot's) respiration occurs in a more severe pathology, when excitability of the respiratory center is reduced to a greater degree than in tidal (Chein-Stocks) respiration.

2. In the pathogenesis of periodic respiration the main significance has hypoxia of the brain and decrease of excitability of the respiratory center to physiological concentration of carbon dioxide.

№ 9

1. The patient developed Kussmaul's respiration.

2. No, it will not be preserved, as breathlessness is supposed to mean the impairment of pulmonary ventilation accompanied by a subjective feeling of air insufficiency. Being in an unconscious state the person cannot preserve the sensation of air insufficiency and associated need to intensify respiration.

№ 10

Pulmonary heart (*cor pulmonale*).

1. Hypoventilation → local hypoxemia and hypercapnia in pulmonary capillaries → hypoxemic vasoconstriction of pre-capillaries (Euler-Liliestrand's reflex) → pre-capillary pulmonary hypertension → chronic overloading of the right ventricle with pressure → hypertrophy of the right ventricle → its decompensation → right-ventricular insufficiency.

№ 11

1. Stenosed respiration.

2. An obstructive type of ventilation impairment. Obstruction of the upper respiratory ways with the development of asphyxia.

LESSON 13. PATHOPHYSIOLOGY OF THE DIGESTIVE SYSTEM

№ 1

1. The X-ray examination with barium allows diagnosing a duodenal ulcer in 90 % of cases. The endoscopic examination is indicated in case of a negative X-ray result, in the ulcer of small sizes and to establish a source of bleeding. On endoscopic examination biopsy allows to identify the presence of *Helicobacter pylori* to administer anti-microbial preparations.

2. The patient has some etiological factors of the disease:

a) Smoking — stimulation of HCl secretion, inhibition of bicarbonate secretion by the pancreas, accelerated evacuation of food from the stomach, suppression of prostaglandins synthesis and regeneration of epithelial cells, angiospasm.

b) Alcohol — perfusion decrease of the mucous membrane, suppression of mucus secretion.

c) Psychoemotional stress — angiospasm resulting in hypoxia of epithelial cells and the impairment of their regeneration.

d) *Helicobacter pylori* — excretes urease (formation of NH_4^+ → hypersecretion of HCl) and protease (splitting of glycoproteins — bases of mucus).

3. Feeling of pain (burning) in the epigastric area in a duodenal ulcer — the result of acid stimulation of nociceptive chemoreceptors and/or a muscular spasm of the stomach wall.

4. The patient should be recommended to give up smoking, using alcohol. He is indicated antacides (decreasing the acidity of gastric juice), antagonists of H_2 -receptors or inhibitors of H^+ , K^+ -ATPase (a decrease of basal and stimulated secretion of HCl) and analogues of prostaglandines (stimulation of mucus production).

№ 2

1. The patient is noted to have the insufficiency of the following functions of the pancreas:

a) secretory (signs: expressed decrease of trypsin activity, steatorrhea, the impairment of stool, meteorism, significant decrease of appetite, losing weight, weakness);

b) incretory (signs of insulin secretion deficiency: hypoglycemia, glucozuria, polyuria, losing weight, weakness).

2. The most probable suggestion — a chronic inflammatory process of an alcoholic etiology and functional insufficiency of islet cells of the gland.

3. With this purpose it was possible to perform a diagnostic laparoscopy or other method of biopsy of the pancreas.

4. The insufficiency of secretory and insecretory apparatuses of the pancreas can develop independently from each other, under the influence of different reasons. However in the analyzed case these processes are interconnected. In chronic alcoholism the secretory apparatus appears more sensitive, reacting with a primary and secondary alteration in the process of inflammation. The damage of the islet apparatus develops, as a rule, later — in progressing of a chronic inflammatory process resulting in the disturbance of blood circulation in it, its fibrosis, etc. On the other hand, the recurring insulin insufficiency can aggravate the course of the inflammatory process, impairing the trophism of the glandular tissue.

5. The following diagnostic suggestion seems the most probable: the primary (alcoholic) chronic pancreatitis complicated by secondary diabetes mellitus.

6. Significant losing weight of the patient is caused basically by two reasons:

a) the impairment of digestion and, hence, absorption of basic components of food — proteins, fats, carbohydrates (due to an expressed secretory insufficiency of the pancreas);

b) the impairment of carbohydrate metabolism, and secondarily — also of protein and fat metabolism (due to the development of diabetes in the patient).

№ 3

No, it will not. In reply to vagus stimulation the juice of high acidity and digesting ability with a greater content of mucus is excreted.

Stressful stimulation causes the excretion of juice with high acidity and digesting ability in a small amount of mucus.

№ 4

1. Glucocorticoids intensify the secretion of gastric juice, stimulating the production of pepsin and hydrochloric acid with main and acid cells and thus raising its digesting ability. Simultaneously glucocorticoids suppress the processes of proliferation and regeneration of gastric mucus, reduce the mucus production. Thus, the basis of steroid ulcers is an increase of the activity of acid-peptic factor on the background of insufficiency of local protective mechanisms of mucous from damage.

2. In the human similar situations can arise in a sharp stress, multiple traumas or in glucocorticoid therapies.

№ 5

1. Narrowing of the pylorus in the experimental animal leads to stagnation of food in the stomach. Prolonged mechanical and chemical stimulation of the pylorus causes excessive excretion of gastrin, acetylcholine accompanied by intensified secretion of gastric juice, increase of its acidity and digesting ability. Intensifying of aggressive properties of gastric juice is the major factor in ulcer formation in this case.

2. In the human a similar situation can arise during a prolonged spasm of the pyloric sphincter or stenosis of the pylorus.

№ 6

Yes, there is. The developed megaloblastic anemia of the patient is the result of deficiency of the internal factor (Castle's factor), developed by parietal cells of the mucous area of the stomach fundus. In the absence of this factor the destruction of vitamin B₁₂ by intestinal microflora intensifies and its absorption is sharply reduced.

№ 7

1. Acute pancreatitis.

2. Cholelithiasis, abusing alcohol, tumors of the pancreas, injury of the stomach, hyperlipidemia, infections, surgical interventions to the thoracic and abdominal organs.

3. The obstruction of a duct or an ampoule of a duodenal papilla results in hypertension in the pancreatic duct with subsequent rupture of fine pancreatic ducts. It leads to excretion of the secret into glandular parenchyma, activation of enzymes and, finally, to self-digestion of the gland. In this case taking of alcohol stimulates increased production of the secret and simultaneously causes the contraction of Oddy's sphyncter, resulting in an increase of the intraductular pressure; it also triggers the disease.

№ 8

1. A heavier state has patient A., as he has symptoms of dehydration of the organism (dry tongue, hypotension, tachycardia, tachypnea).

2. The «Osmotic difference» of the electrolyte content of feces in patient A. is $290 - 2 \times (100 + 40) = 10$ mosmol/l (norm) that points to a secretory development mechanism of diarrhea.

The «Osmotic difference» of the electrolyte content of feces in patient M. is $330 - 2 \times (30 + 30) = 210$ mosmol/l ($>$ norm). Probably, patient M. developed an osmotic diarrhea, connected with prolonged taking of Mg-containing antacid maalox. The osmotic mechanism of diarrhea is confirmed by complaints of the patient associated with meals.

3. To specify the cause of diarrhea the bacteriological examination of patient's A. feces should be carried out.

Regarding patient M. it is necessary to exclude other causes of an osmotic diarrhea: secretory insufficiency of the pancreas and liver, damage of the epithelium of the small intestine resulting in the impairment of absorption mechanisms (the syndrome of malabsorption).

4.

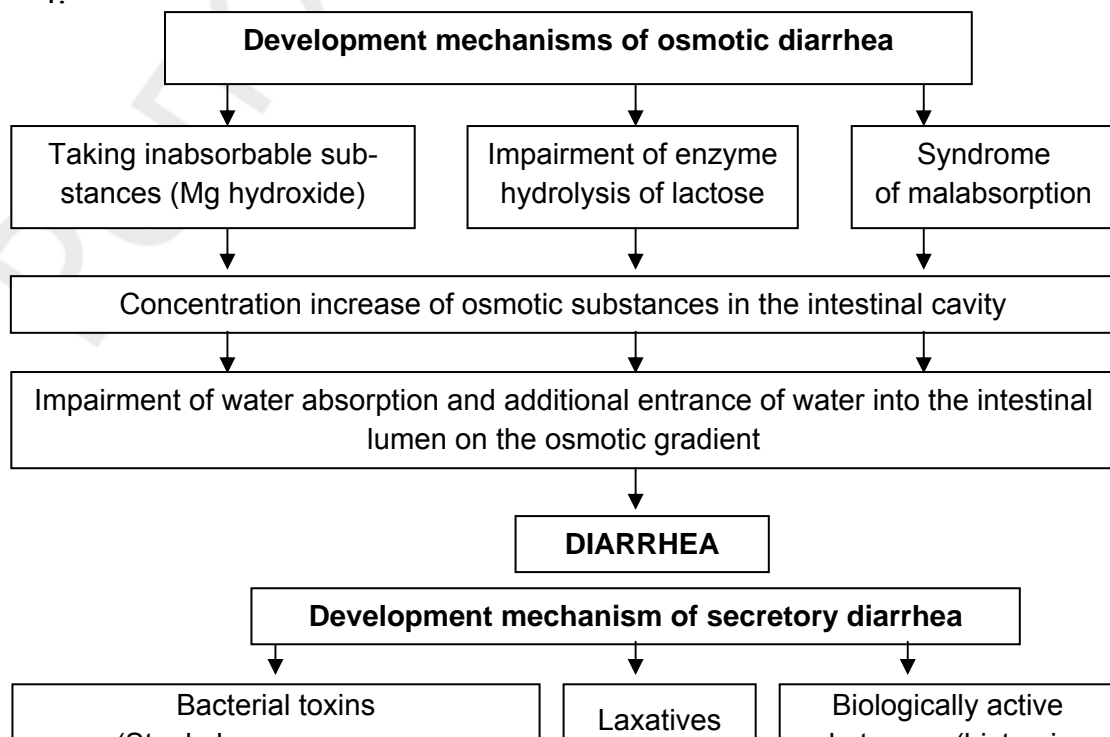

5. In prolonged diarrhea a non-respiratory excretory acidosis may develop due to a loss of HCO_3 ions of the intestinal contents. Expressed acidosis is manifested by the depression of CNS and hypotension, compensatory breathlessness.

LESSON 14. PATHOPHYSIOLOGY OF THE LIVER

№ 1

Under the conditions when fats are not absorbed in the small intestines, there will be also impaired the absorption of fat-soluble vitamins, particularly of vitamin K, which is necessary for synthesis of so-called K-vitamin-dependent coagulating factors — prothrombin, proconvertin, factor of Stuart-Prauer, a plasmatic component of thromboplastin. Insufficient synthesis of these factors entails the impairment of the coagulation process and occurrence of hemorrhagic phenomena.

№ 2

1. Erythema of the palms is due to changing of the wall structure of microvessels, including the dilation of capillaries, with adventitia thickening in the zone of venules and their dilation (teleangiectasia). Structural changes are caused, basically, by an excess of estrogens. Usually these symptoms appear in dystrophic lesions of the liver, as hepatic cells lose their ability to inactivate steroid hormones, including those of the adrenal origin.

2. The causal factors of a portal hypertension and ascites can be:

a) Long-term elevation of systemic venous pressure in the right-ventricular cardiac insufficiency. Venous plethora of the liver results in dystrophic changes there and destruction of microvessels due to the development of sclerosis (cirrhosis);

b) Thrombosis or embolism of the portal vein vessels;

c) Direct lesion of the parenchyma (viral, toxic, alcoholic) can end with destruction of a significant amount of hepatocytes and development of cirrhosis. It makes it impossible the normal passage of blood through hepatic capillaries that leads to the development of stagnant venous hyperemia of the intestines. The impairment of transcapillary exchange results in penetration of fluid from microvessels and its accumulation in the abdominal cavity — in the development of ascites.

Secondary consequences: draining of a part of fluid from the total volume of circulating blood, mechanical squeezing of abdominal organs.

3. The laboratory parameters revealing the damage of hepatic cells and the presence of hepatic insufficiency:

– impairment of protein exchange (hypoalbuminemia, blood hypoconcentration, oncotic edemas);

– decrease of the prothrombin level (impairment of blood coagulation);

– decrease of the blood cholesterol level;

– a low blood urea level;

– increase of the blood bilirubin content;

– hyperfermentemia, characterized by getting of enzymes (AlAT and AsAT) into the blood from damaged hepatic cells.

4. Taking into account the clinical and laboratory data of a severe hepatic injury, it is possible to suggest a precomatous condition of consciousness.

№ 3

I (table 8) — suprahepatic; II (table 9) — subhepatic; III (table 10) — hepatic.

№ 4

Parenchymatous (epithelial-cellular) jaundice.

№ 5

The specified symptoms are characteristic of a parenchymatous (epithelial-cellular) jaundice.

№ 6

The patient has an intrahepatic form of portal hypertension.

№ 7

For a mechanical jaundice.

№ 8

Epygastric bleeding was a complication of portal hypertension (its intrahepatic form).

№ 9

The patient has a suprahepatic form of portal hypertension.

№ 10

1. The child has a hemolytic jaundice.
2. Its cause is an intensified hemolysis of erythrocytes due to formation of anti-bodies in the maternal organism to erythrocytes of the child.

№ 11

1. The patient has a mechanical (obturation, stagnant) jaundice.
2. Accounting the anemnesis, its most probable reason is the obstruction of a bile duct by a bile stone.

№ 12

A mechanical (stagnant) jaundice.

№ 13

A mechanical jaundice.

№ 14

An intrahepatic form of portal hypertension.

LESSON 8. PATHOPHYSIOLOGY OF KIDNEYS

№ 1

In renal diseases characterized by predominant lesion of nephron glomeruli and accompanied by the impairment of their excretory function anemia is often observed. As a rule it may be normocytic, normochromous, hyporegenerator.

Pathogenetically it is associated with:

- a decrease of erythropoietine production;
- a production increase of erythropoiesis inhibitors (in the juxtoglomerular apparatus of kidneys).

Of additional value are:

- depression of the bone marrow by substances containing nitrogen;
- hematuria;
- Fe-deficiency (due to a decrease of Fe-reabsorption and increase of transferrin loss with urine in proteinuria);
- Deficiency of B₆.

The aforementioned factors result in inhibition of DNA synthesis on the bone marrow cells sensitive to erythropoietine, impairment of their differentiation, decrease of normocytes proliferation and decrease of reticulocytes exit from the bone marrow into the blood.

№ 2

1. Renal insufficiency is manifested by a decrease of glomerular filtration, increase of urea concentration in the blood, polyuria, hypostenuria, nocturia,

anemia, hypertension. All these signs are characteristic of the initial stage of chronic renal insufficiency (the stage of a relative insufficiency or a polyuretic one).

2. Yes, as the nocturnal diuresis prevails over the diurnal one.
3. Yes, as it is frequent urination that is pollakiuria.

№ 3

1. Chronic renal insufficiency, a decompensation stage (anuric).
2. Yes there are: apathy, pain in muscles and joints, itching, ammonium smell from the mouth, hypertension, a sharp decrease of glomerular filtration, oliguria, isostenuria.
3. An increase of residual nitrogen in the blood at the stage of decompensation in chronic renal insufficiency is provided mainly at the cost of increasing concentration of urea, creatine, uric acid, creatinine, ammonium, indican.

№ 4

1. The patient has chronic insufficiency, a decompensation stage.
2. The decrease of glomerular filtration in chronic renal insufficiency is explained by a decrease of the amount of functioning nephrons due to their death.

№ 5

1. Acute renal insufficiency, a polyuric form.
2. Polyuria at this stage of renal insufficiency is explained by the fact, that the reabsorbing ability of canaliculi to regenerate the epithelium is not high yet. The defect of canaliculi reabsorption causes a concentration increase of active substances of the canaliculi fluid accompanied by an appropriate increase of the amount of excreted urine.

№ 6

1. The patient has renal insufficiency, an oligoanuric stage.
2. Oliguria in the patient is explained by a decrease of glomerular filtration due to a drop of hydrostatic pressure in renal capillaries in a sharp decrease of arterial pressure.

№ 7

1. Does not evidence, as in the impairment of an excretory function of the kidneys, hyperazotemia develops at the cost of accumulation of urea and creatinine in the blood, which are usually excreted with urine.
2. Increasing of serum aminonitrogen, decrease of the urea content suggest a hepatic origin of hyperazotemia.

№ 8

1. Proteinuria, leukocyturia, cylinduria.
2. Proteinuria, azotemia, oliguria.
3. A small range of fluctuations of relative density of urine (isostenuria) in Zimnitsky test evidences the concentration ability impairment of the kidneys.

№ 9

1. Proteinuria, leukocyturia, macrohematuria, epithelial cells.
2. The impairment of filtration ability of the kidneys is evidenced by proteinuria, hematuria, decrease of glomerular filtration from 110–125 to 56 ml/min.
3. A possible mechanism of decreasing the glomerular filtration is the impairment of intraglomerular blood flow caused by alteration of glomerular capillaries, their squeezing with accumulating exudate.

№ 10

The reabsorption ability of the patient's kidneys is impaired. The mechanism of glucosuria means a decrease of canaliculi reabsorption of glucose that may be caused by a hereditary defect of fermentative systems taking part in canaliculi glucose transport.

№ 11

1. Anuria of the patient is explained by sharp limitation of glomerular filtration caused by a decrease of hydrostatic pressure in glomerular capillaries due to a decrease of systemic arterial pressure.
2. The patient has an extrarenal form of anuria.

№ 12

1. This model proves an immune nature of glomerulonephritis.
2. Nephritic.

№ 13

The development of expressed oliguria on the background of an inconsiderable decrease of glomerular filtration can be explained by a predominant lesion of the proximal department of canaliculi. This part of a nephron, characterized by the highest activity of exchange processes, is very sensitive to a damaging action of nephrotoxic substances that cause epithelium necrosis of canaliculi. As a result of the damage of canaliculi epithelium the glomerular filtrate completely comes into the interstitial tissue of the kidney and from there is absorbed into the blood flow. Consequently, in this case anuria is explained not so much by the impairment of the renal blood flow and glomerular filtration as by reabsorption of primary urine through a damaged wall of the canaliculi.

№ 14

1. Polyuria of the patient is explained by a high content of glucose in the urine. Being an osmotically active substance, glucose interferes with water absorption in canaliculi and takes it away.
2. A high relative density of urine is explained by a great content of glucose there.

№ 15

1. Shock, cardiac insufficiency, poisoning with mushrooms, mercury, using nephrotoxic antibiotics (aminoglycosides, amphotericin B), squeezing or obturation of urinary ways by a tumor or stones, inflammatory renal diseases (fast advancing glomerulonephritis, etc.), damage of renal vessels, trauma or re-

removal of the only kidney). In this case we can suggest that ARI (acute renal insufficiency) was caused by taking of gentamycin.

2. The forms of ARI: prerenal, renal, postrenal, arenal. Stages: an initial period; a stage of oligo-anuria; a stage of restoring the diuresis (polyuria); recovery.

3. Hypoxic or toxic impairment of canalculi epithelium with the development epitheliocytes necrosis + impairment of the renal blood flow → impairment of filtration and impossibility of reabsorption → «leakage» of the filtrate into the tissue of the kidney → oligo-anuria.

4. It is possible to restore renal functions by intensive therapy.

№ 16

1. Chronic glomerulonephritis, chronic pyelonephritis, urolethiasis, polycystosis of the kidneys.

2. Progressive decrease of the amount and function of functioning nephrons is caused by excessive hemodynamic loading on the capillaries of the glomerulus of remained intact nephrons. Excessive perfusion, intraglomerular hypertension and hyperfiltration damage of the endothelium of capillaries and result in sclerosis of glomeruli.

3. Uremic encephalopathy — increasing of intracranial pressure, headache, apathy, domination of inhibition processes, pathologic reflexes, loss of consciousness. Uremic cardiopathy — hypertrophy of the myocardium, arrhythmias. On the part of GIT (gastro-intestinal tract) — hypersalivation, nausea, vomiting, gastro-intestinal bleedings, impairment of absorption processes.

4. Impairment of calcium absorption in the intestines → hypocalcemia → compensatory hypersecretion of parathormone → resorption of the bony tissue.

LESSON 9. PATHOPHYSIOLOGY OF THE NERVOUS SYSTEM. THE IMPAIRMENT OF SENSOR AND LOCOMOTOR FUNCTIONS

Situational tasks

№ 1

1. Parkinson's syndrome (disease). The triad of symptoms is characterized by: tremor, muscular rigidity, akinesia (in this case — a difficult beginning and completion of the movement).

2. This pathology is associated with the damage of dopamine energetic neurons of the nigral substance of the middle brain.

3. Parkinsonic tremor is revealed mainly at rest, on movement it disappears.

№ 2

1. Chorea.

2. Damage of the striated body.

№ 3

1. The left-side impairment of the spinal cord at the level of thoracic segments.

2. Syndrome of Broun-Sekar.

3. The semiology is caused by the topography of a descending motor and ascending sensor ways. The descending cortico-spinal tract passes on the **ipsilateral** side relative to innervated muscles, that is why a left-side paralysis develops in the left-side impairment of the spinal cord. The ascending gangliary-bulbary tract conducting muscular-articular and vibration sensitivity also passes along the ipsilateral side relative to appropriate receptive fields, that is why the impairments of deep sensitivity develop on the side of lesion (in this case — on the left). The spinal-thalamic tract carrying the information from temperature and pain receptors passes in the spinal cord on the **contralateral** side; accordingly the impairments of superficial sensitivity develop on the side opposite to localization of the spinal cord lesion.

№ 4

This semiology (ataxia, asthenia, astasia-abasia, asynergy, nystagmus, scanned speech) is characteristic of a cerebellum lesion.

№ 5

This patient has Broun-Sekar syndrome with the lesion of the right part of the spinal column.

№ 6

1. The girl has hyperkinesis in the form of tick.

2. The mechanism of its origin can be associated with the lesion of basal ganglia and the brain cortex. The conditional-reflex mechanism is also possible.

№ 7

1. The patient has a left-side hemiparesis.

2. Increasing of the muscular tone and periosteal reflexes in the specified extremities is associated with disinhibition of motor neurons of the spinal cord as a result of a lesion of the central neuron of the cortical-spinal tract.

№ 8

The patient has the impairment signs of the extrapyramidal system with the appearance of parkinsonic tremor, probably, on the background of functional impairment of interrelations between such basal ganglia as a striated body, pale ball, nigral substance.

№ 9

1. The patient has a left-side hemiparesis.

2. Increasing of the muscular tone and periosteal reflexes in the specified extremities are associated with disinhibition of motor neurons of the spinal cord as a result of lesion of the central neuron of the cortical-spinal tract.

№ 10

The girl has hyperkinesia in the form of choreic convulsions. The mechanism of its origin can be associated with a lesion of basal ganglia (striated body) or the brain cortex of the hemispheres.

№ 11

1. This patient has a left-side hemiplegia as a result of a lesion of the central neuron of the cortical-spinal tract.

2. Increasing of the muscular tone and spinal reflexes of affected extremities are associated with releasing the inhibition of motor neurons of the spinal cord.

№ 12

1. The patient has hyperkinesias in the form of intentional tremor. The mechanism of its origin can be associated with the lesion of the cerebellum system.

2. An intentional tremor is high-amplitude, intensifies in performing movements (tremor of movement). It disappears at rest. A parkinsonic tremor is low-amplitude, is noted at rest (tremor of rest). And on the contrary, on movement the parkinsonic tremor disappears.

№ 13

The patient has a peripheral paresis of the right extremity due to a traumatic lesion of the peripheral (sciatic) nerve.

№ 14

The patient had an epileptic form of convulsions.

№ 15

1. The patient developed a hysteric type of reaction with inclination to demonstrate manifestations of the disease on offences and failures.

2. The patient with hysteric features and some psychoasthenic features (self-insurance, overanxiousness) in the period of life difficulties, the necessity of taking important decisions developed a hysteric neurosis. It is this morbid state (characterized mainly by phobias) that motivated the refusal to go to work for the appointment. The maniacal symptomatic complex of this patient contains lots of demonstration, aspiration to avoid difficulties. It is characteristic of personalities with a weak type of the nervous system.

№ 16

1. This patient is characterized by the presence of a constant contradiction between his possibilities from one side and too high demands to himself — from the other. The feeling of pain in the heart area, tachycardia and arterial hypertension are likely to be due to overstrain and failure of the inhibition process in CNS. It is accompanied by domination of excitation over inhibition.

2. The patient developed neurasthenia. It is formed as a result of constant unhealthy aspiration for personal success without reasonable assessment of his own capabilities and possibilities. More often such type of neurosis develops in personalities with a strong but imbalanced type of (HNA) high nervous activity.

LESSON 10. PATHOPHYSIOLOGY OF THE ENDOCRINE SYSTEM

Situational tasks

№ 1

1. Hypersecretion of iodine-containing thyroid hormones.
2. Basedow's disease.

№ 2

1. Of the posterior lobe of the hypophysis.
2. Incipidus diabetes and incipidus urinismuria.

№ 3

1. Hyperfunction of a glomerular zone of the adrenal cortex
2. Konn's syndrome or primary hyperaldosteronism.
3. In Konn's syndrome excessively secreted aldosterone causes a sharp increase of sodium reabsorption and potassium excretion from the organism. Hypokalemia and potassium deficiency inside the cells (including the epithelium of renal canaliculi) results in the development of so-called hypokaliemic nephropathy with dystrophic changes of renal canaliculi resulting in a sharp decrease of sensitivity of epithelial receptors of canaliculi to ADH. As a result of these pathologic changes the water in distal parts of a nephron is not reabsorbed but is excreted in great amounts from the organism: polyuria, nocturia and hypostenuria are observed.

In secondary **hyperaldosteronism** the level of aldosterone is increased not so much and its effects (sodium retention and potassium excretion) are not accompanied by an expressed deficiency of potassium. In this pathology the sensitivity of epithelial receptors of renal canaliculi to ADH is not impaired, that is why in response to an increase of sodium reabsorption an adequate increase of ADH secretion and an appropriate retention of water occur; excessive accumulation of water in the organism causes the development of arterial hypertension and **edematous syndrome**.

№ 4

1. The impairment of the anterior lobe of the hypophysis.
2. Simmonds' disease or hypophyseal cachexia.

№ 5

1. Of the adrenal cortex.
2. Adrenogenital syndrome.
3. Clinical forms: **simple viral** (in deficiency of 21-hydroxylase); **salt-losing** (in deficiency of 18-hydroxylase); **hypertensive** (in deficiency of 11 β -hydroxylase). This patient has a hypertensive form of the adrenogenital syndrome.

№ 6

1. Diabetes mellitus of I type.

2. Ketoacidotic coma.

3. Insulin deficiency results in the reduction of glucose consumption by peripheral tissues, as a result the main energetic substrates become free fatty acids that come into the blood in great amounts due to a sharp activation of lipolysis. Sharp intensification of mobilizing of fatty acids and their capture with cells results in considerable accumulation of acetylcoenzyme A in the cells. In insulin insufficiency and oxidation of glucose, acetylcoenzyme A cannot completely enter the Krebs' cycle due to a limited metabolic potency of the latter (in this case fats **incompletely** «burn in the flame of carbohydrates»). That is why excessively accumulated acetylcoenzyme A is spent for synthesis of ketonic bodies — acetoacetic, β -oxibutyric acids and acetone, which possess toxic and narcotic properties and cause to a considerable extent the development of a ketoacetotic coma. An additional source of ketonic bodies may serve ketogenic amino acids (isoleucin, leucin, valin) formed in excess as a result of increased metabolism of the protein.

4. The basic pathogenesis links of a ketoacidotic coma: hyperglycemia → polyuria → dehydration → hypovolemia → insufficiency of cerebral blood supply → hypoxia of CNS. Ketoacidosis → depression of CNS + secondary hypokalemia + cardio-vascular insufficiency with hypotension → metabolic coagulation → progressive circulation impairment of the vital organs (first of all, CNS) with hypoxia and impairment of their functions.

№ 7

1. Of parathyroid glands. Hypersecretion of parathormone.

2. Fibrous osteodystrophy.

№ 8

1. Of the anterior lobe of the hypophysis. Hypersecretion of ACTH, more often of a tumor origin (a basophilic adenoma of the hypophysis).

2. The disease of Itsenko-Kushing.

3. The syndrome of Itsenko-Kushing.

4. A low level of ACTH is caused by triggering of a negative feed-back mechanism in the system of hypothalamus-hypophysis-adrenal cortex, when a high level of the peripheral hormone (cortisole) in the blood depresses synthesis of the tropic hormone of the hypophysis (ACTH).

№ 9

A hypoglycemic coma.

№ 10

Postpartum hypopituitarism (Shean's syndrome) caused by an ischemic lesion of the anterior lobe of the hypophysis due to a great loss of blood during deliveries.

№ 11

1. On increased production of the growth hormone (somatotropic) by the anterior lobe of the hypophysis.

2. Acromegaly. The disease as a rule is caused by an eosinophilic adenoma of the hypophysis or by hyperplasia of its acidophilic cells producing the growth hormone.

№ 12

1. For chronic adrenal insufficiency (Addison's disease).

2. The occurrence of hyperpigmentation is associated with intensification, on the mechanism of a negative feed-back, of the synthesis of **proopiomelanocortine** in the hypothalamus being a common progenitor of corticoliberine and melanocytostimulating hormone (MCH), an increase of secretion of MCH and ACTH in the hypophysis and deposition of **melanine** in the skin and mucous membranes.

3. Hypotension is caused by a production decrease of glucocorticoids and aldosterone. In insufficient aldosterone secretion the organism loses sodium ions followed by a loss of water and, accordingly, hypovolemia. The sodium loss results in the impairment of electrolyte balance of the vascular wall and decrease of the mass of circulating blood. Besides, the decrease of a permissive action of glucocorticoids on the vessels cause the development of arterial hypotension.

4. Raving of the child for salty food is explained by an increase of the organism need in sodium ions as the latter are intensively excreted from the organism under the condition of hypoproduction of aldosterone.

5. In aldosterone deficiency the sodium ions are excreted from the organism while the potassium ions are retained resulting in the development of hyperkalemia. That is why the diet rich in sodium salts and restricted in potassium should be recommended.

№ 13

Hypothyrosis.

№ 14

1. Kushing's syndrome of a yatrogenous (medication) origin.

2. Hypoglycemia and hypotension are manifestations of glucocorticoids discontinuation syndrome. The previous prolonged taking of glucocorticoid preparations resulted, on the mechanism of a negative feed-back, in the suppression or complete cessation of secretion of proper hormones. In the situation, when the patient abruptly stopped taking exogenous steroids by himself, while the production of his own hormones was suppressed, there occurred a deficiency of glucocorticoids and their effects, which by clinical manifestations remind adrenal insufficiency with characteristic signs: hypotension and hypoglycemia.

№ 15

Hypoglycemia in this patient is, most probably, caused by a tumor of β -cells of the pancreas with hypersecretion of insulin — insulinoma.

№ 16

Postoperative hypoparathyroidism.

№ 17

The following is characteristic of ketoacidosis (A): 1, 2, 3, 5, 9, 10, 11, 14, 15, 16, 18, 19, 20, 21, 22, 23 and 26.

For the hypoglycemic condition (B): 4, 6, 7, 12, 13, 17, 18, 24 and 25.

Репозиторий БГМУ

Учебное издание

Висмонт Франтишек Иванович
Касап Валентина Александровна
Жадан Светлана Анатольевна и др.

ПАТОЛОГИЧЕСКАЯ ФИЗИОЛОГИЯ

PATHOLOGICAL PHYSIOLOGY

Сборник ситуационных задач и дополнительная информация
к практическим занятиям на английском языке

Ответственный за выпуск Ф. И. Висмонт
В авторской редакции
Компьютерная верстка Н. М. Федорцовой

Подписано в печать 21.01.10. Формат 60×84/16. Бумага писчая «Кюм Люкс».

Печать офсетная. Гарнитура «Times».

Усл. печ. л. 10,23. Уч.-изд. л. 7,94. Тираж 50 экз. Заказ 458.

Издатель и полиграфическое исполнение:
учреждение образования «Белорусский государственный медицинский университет».
ЛИ № 02330/0494330 от 16.03.2009.
ЛП № 02330/0150484 от 25.02.2009.
Ул. Ленинградская, 6, 220006, Минск.